

1 TYPICAL ROADWAY SECTION SERVICE ROAD AT WAREHOUSE (NOT TO SCALE)

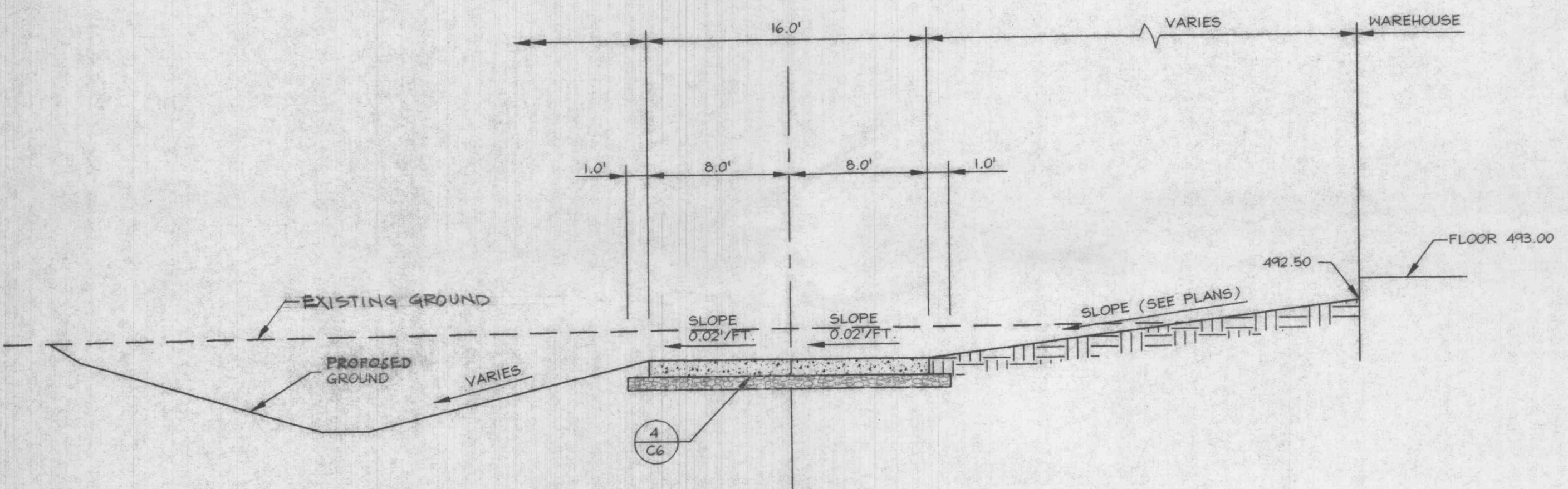

2 TYPICAL ROADWAY SECTION SERVICE ROAD AT WAREHOUSE (NOT TO SCALE)

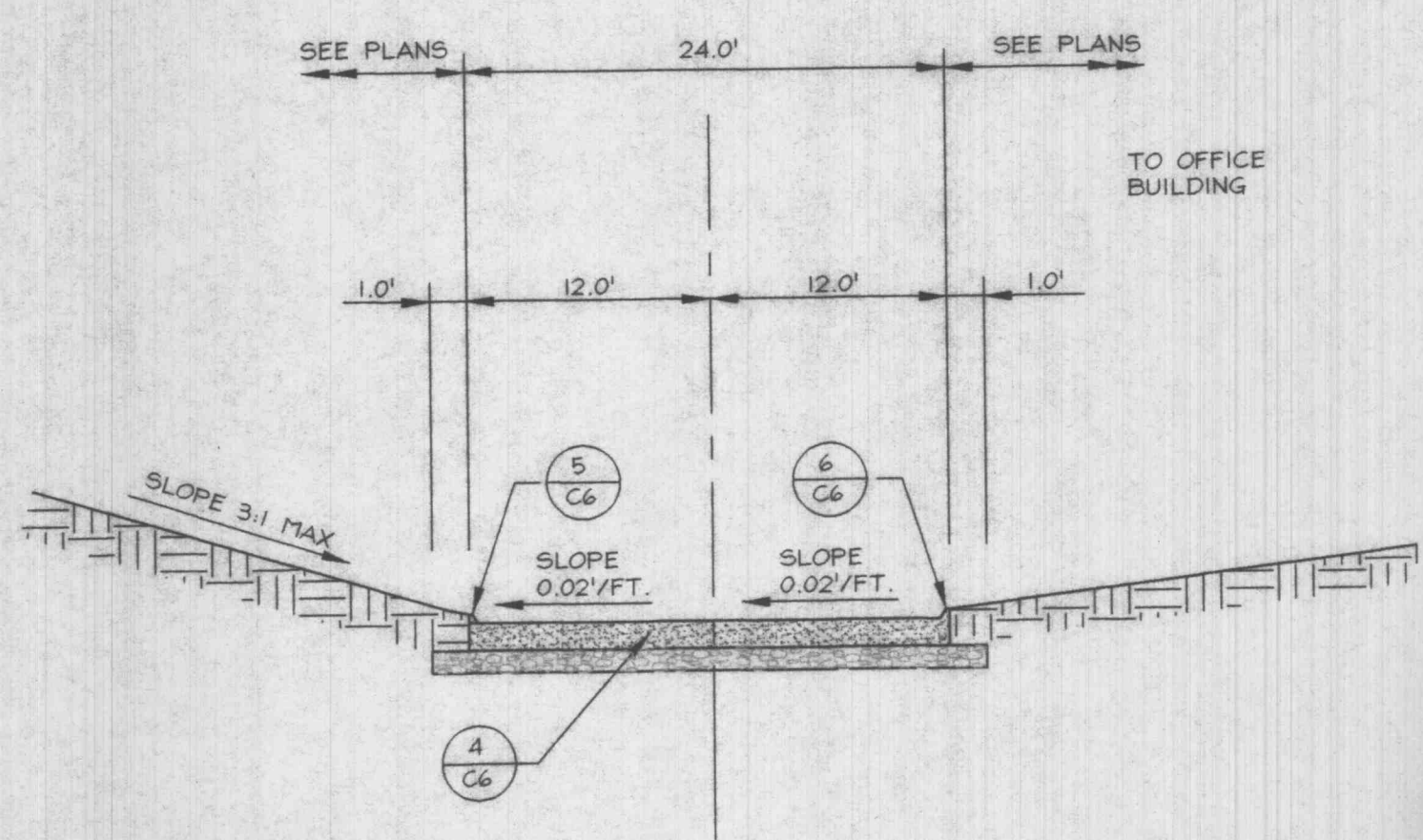

3 TYPICAL ROADWAY SECTION SERVICE ROAD AT OFFICE (NOT TO SCALE)

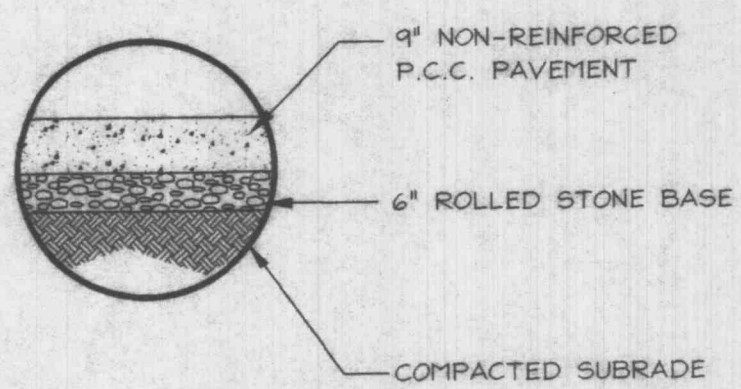

4 CONCRETE PAVEMENT SECTION (NOT TO SCALE)

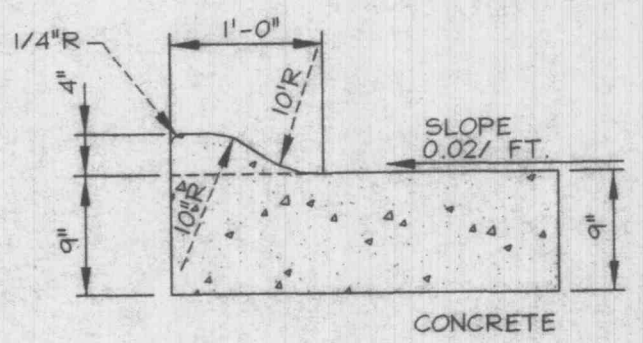

5 ROLLED TYPE CURB MOUNTABLE (NOT TO SCALE)

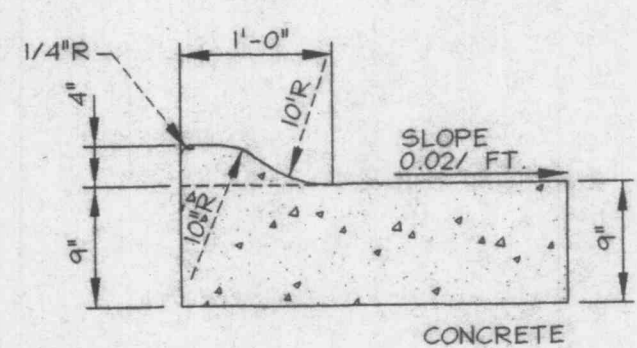

6 ROLLED TYPE CURB MOUNTABLE (NOT TO SCALE)

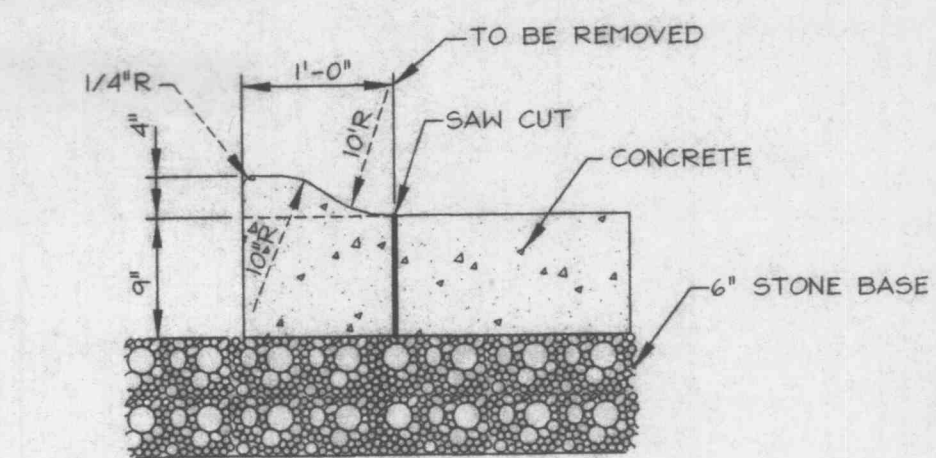

7 EXISTING ROLLED CURB (NOT TO SCALE)

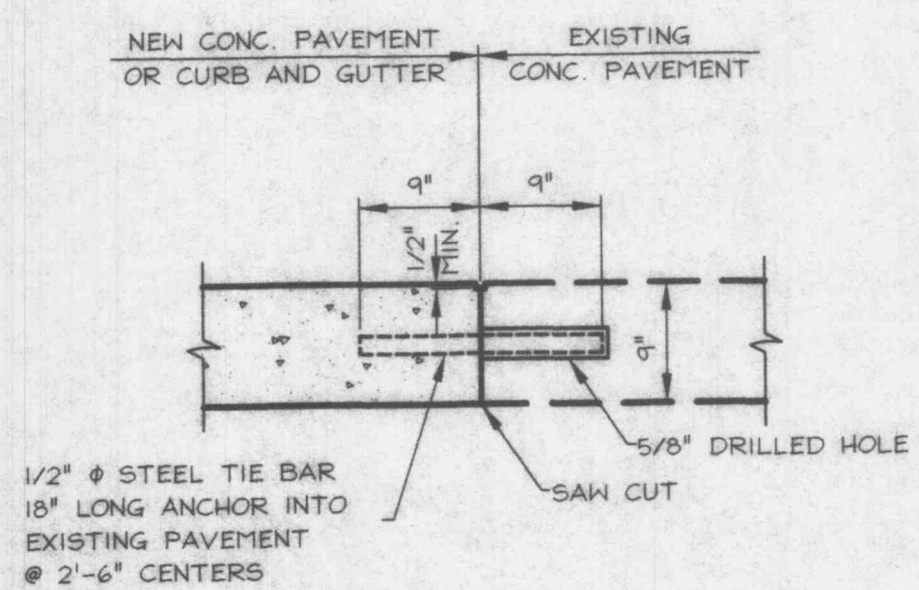

8 JOINT DETAIL (NOT TO SCALE)

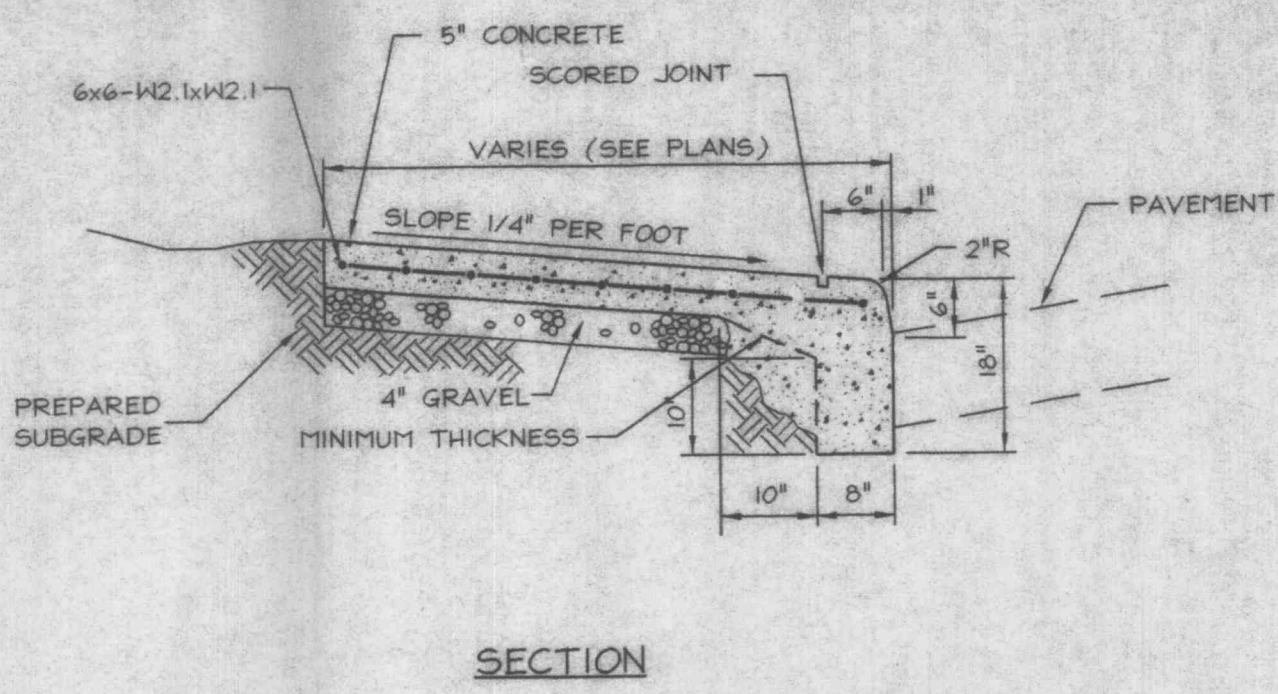

9 COMBINATION WALK & BARRIER CURB (NOT TO SCALE)

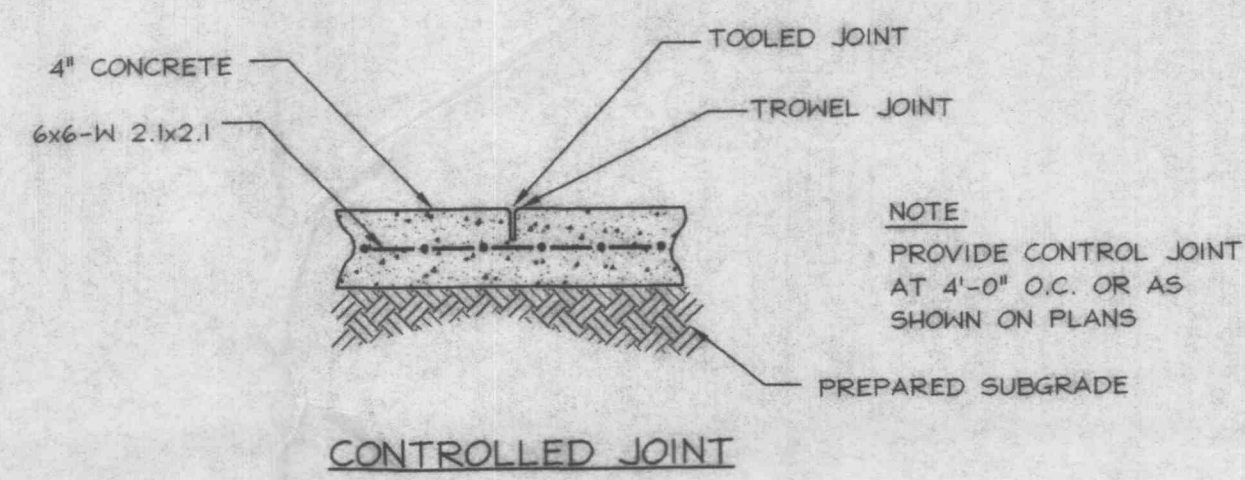

10 CONCRETE SIDEWALK JOINTS FOR REINFORCED SIDEWALK (NOT TO SCALE)

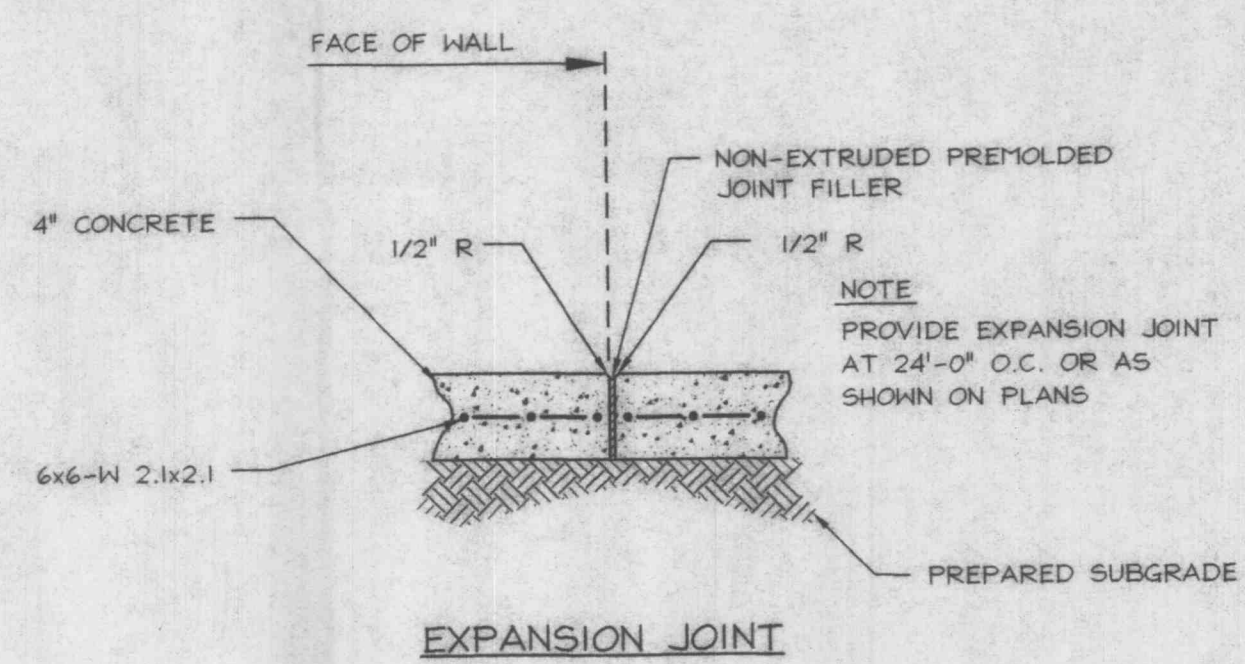

11 CURB TRANSITION (NOT TO SCALE)

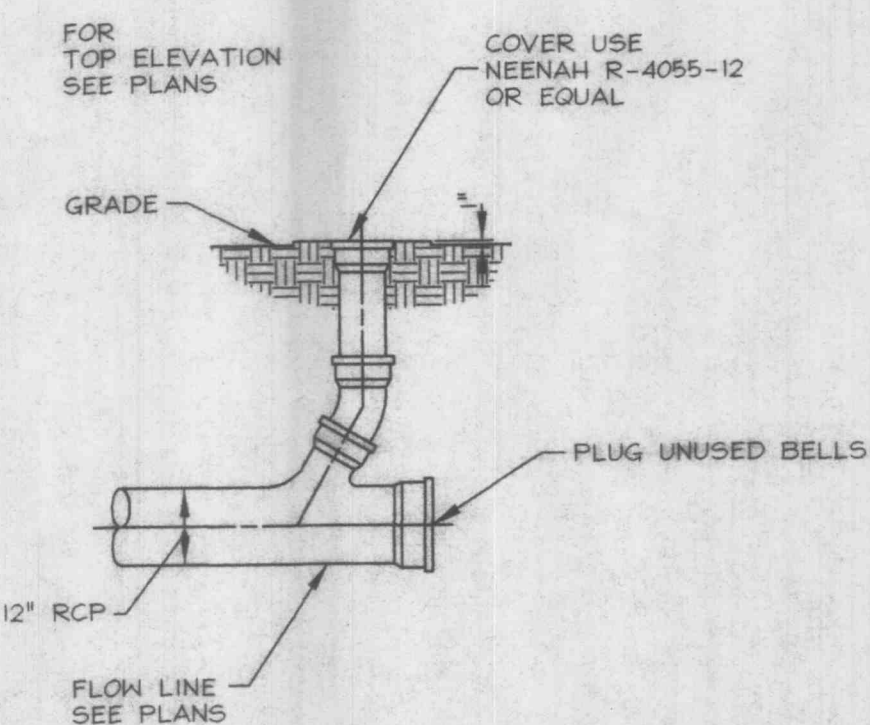

12 CLEANOUT (NOT TO SCALE)

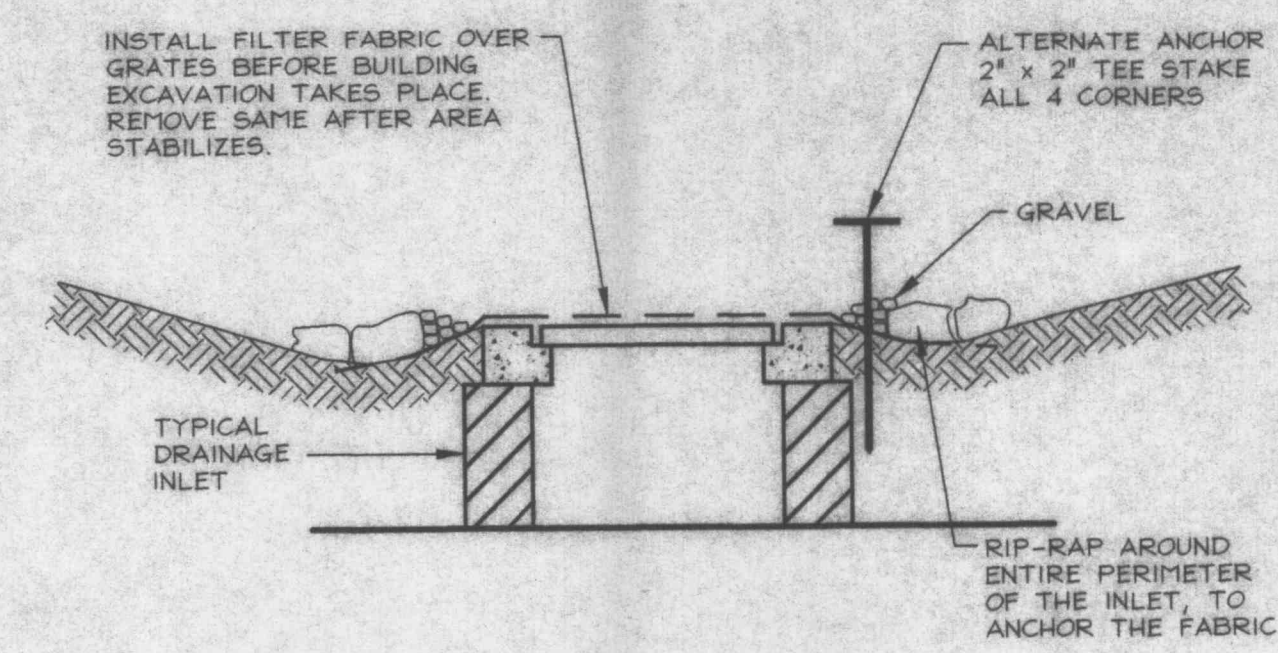

13 SEDIMENTATION CONTROL (NOT TO SCALE)

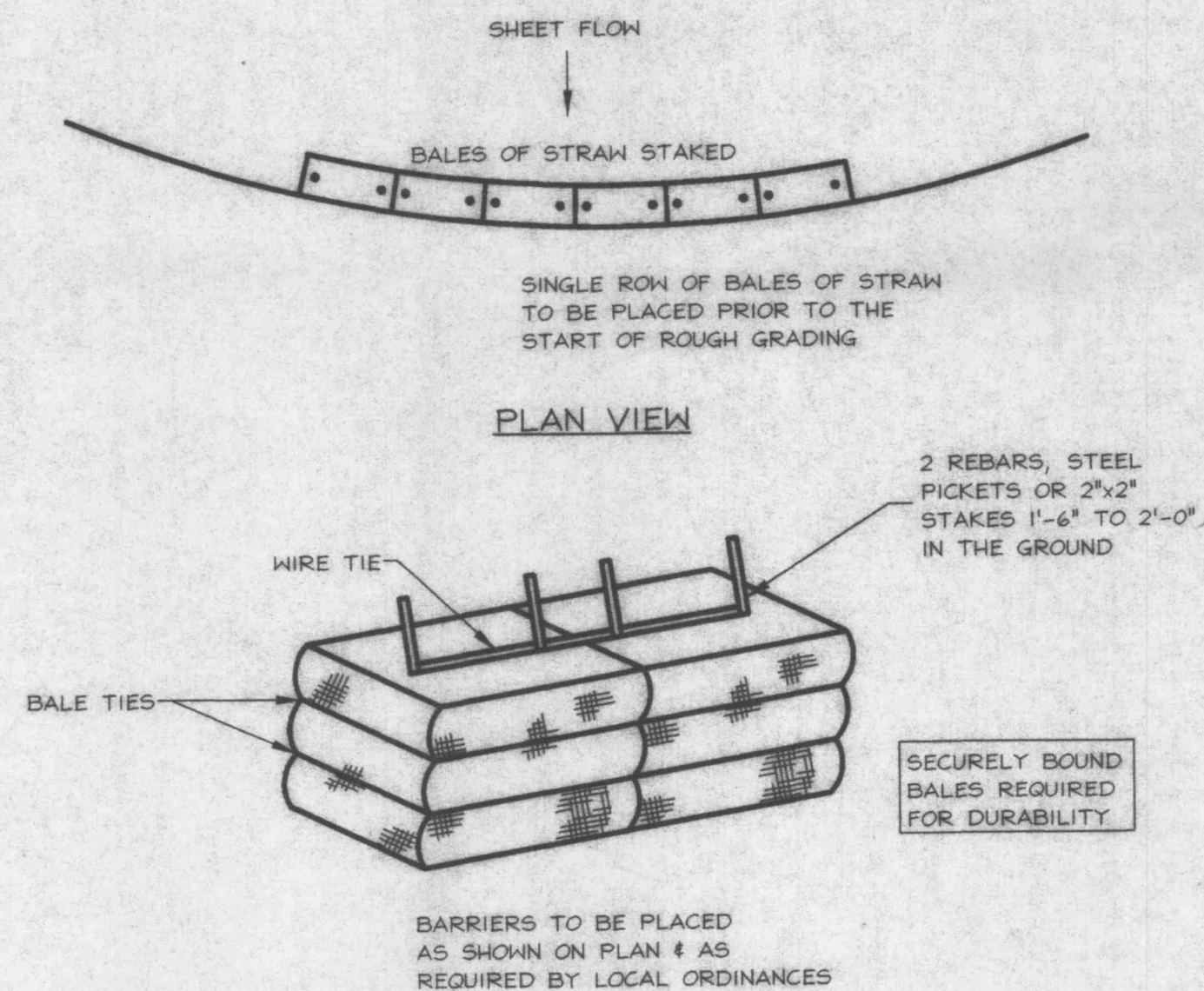

14 TEMPORARY SEDIMENT BARRIERS (NOT TO SCALE)

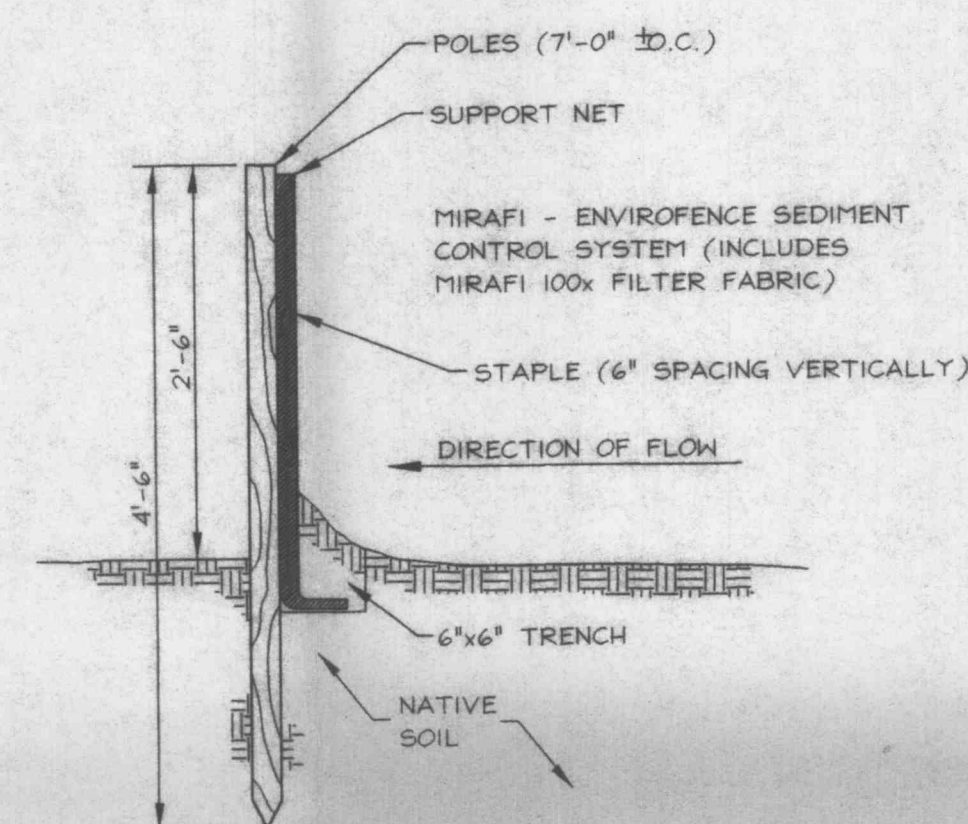

15 SILT RETENTION FENCE (NOT TO SCALE)

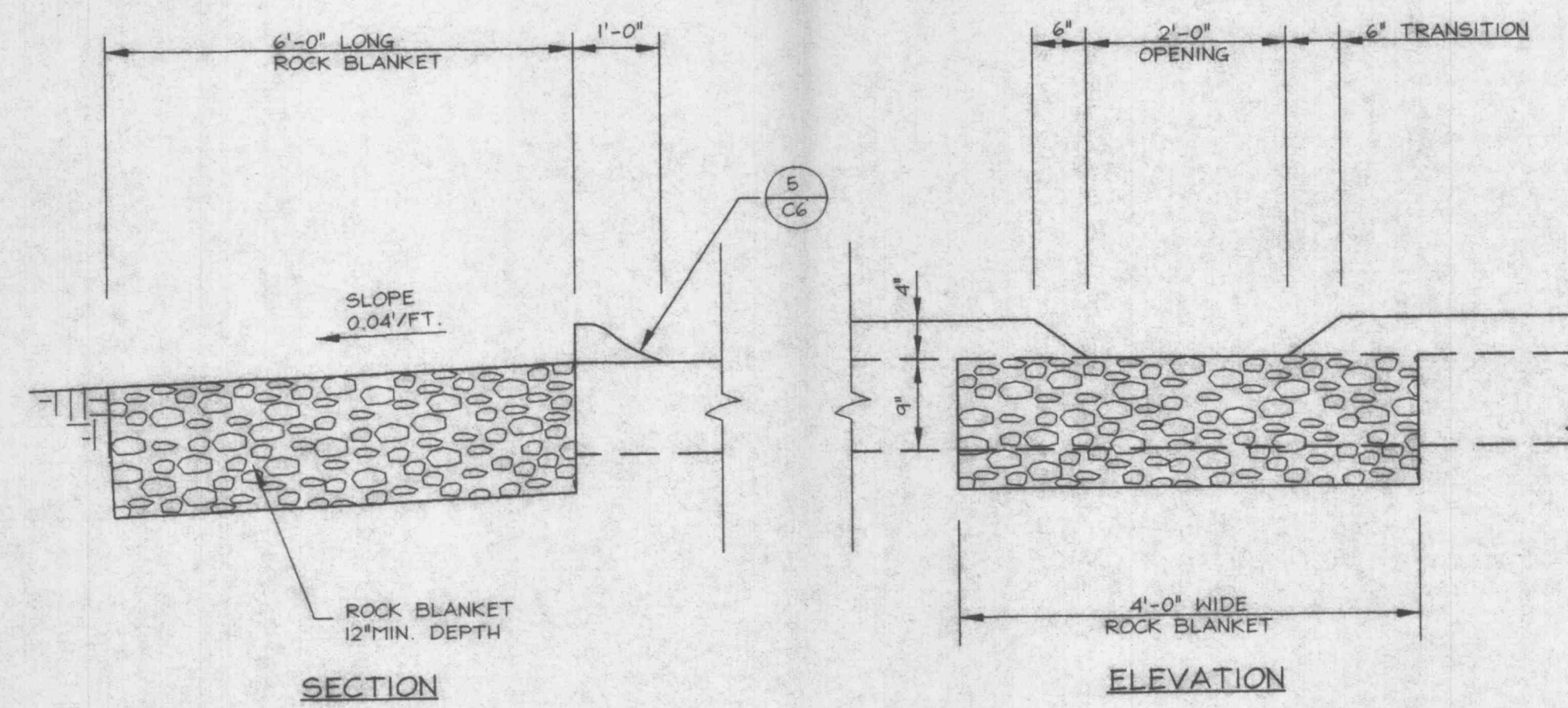

16 CURB CUT (NOT TO SCALE)

ENGINEERS / SURVEYORS AUTHENTICATION
 THE RESPONSIBILITY FOR PROFESSIONAL LIABILITY ON THIS PROJECT IS HEREBY ASSUMED BY THE ENGINEER / SURVEYOR. ANY AND ALL CHANGES TO THE PROJECT SIGNATURE OR SURVEYORS SIGNATURE AND DATE HEREUNDER ATTACHED. RESPONSIBILITY IS DISCLAIMED FOR ALL OTHER PLANS IN THIS PROJECT. REVISED AND SPECIALLY EXCLUDED REVISIONS AFTER THIS DATE SHALL BE INDICATED BY A REVISION NUMBER AND DATE. REVISIONS SHALL BE INDICATED BY A REVISION NUMBER AND DATE. REVISIONS SHALL BE INDICATED BY A REVISION NUMBER AND DATE. REVISIONS SHALL BE INDICATED BY A REVISION NUMBER AND DATE.

Bovis
 Land Lease
 BOVIS LEASE, INC.
 CHARTERED ACCOUNTANTS
 2850 WEST 100th AVENUE
 SUITE 600
 CHARLOTTE, NC 28217

PROJECT NO.	00-225	DATE	ISSUE
DESIGN BY	R.J.	DATE	
DRAWN BY	C.B.	DATE	
APPROVED BY	R.J.	DATE	
DATE	6-11-01	DATE	
NO.	1	NO.	
NO.		NO.	
NO.		NO.	
NO.		NO.	

distribution facility expansion
aldi
 O'FALLON, MISSOURI

Site Details
Berutti
 BERUTTI & ASSOCIATES, INC.
 ENGINEERS / PLANNERS / SURVEYORS
 PREPARED BY: [Signature]
 CHECKED BY: [Signature]
 DATE: 6/12/01
 SHEET C6 OF 8
 DRAWING NO. 00225C6.DWG