

PIPE BEDDING CLASS "C" (FOR ALL PIPE EXCEPT REINFORCED CONCRETE PIPE)
 METROPOLITAN ST. LOUIS SEWER DISTRICT Standard Details of Sewer Construction
 Dr. W.S.H. Ch. J.C.K. 1992 SHEET 3

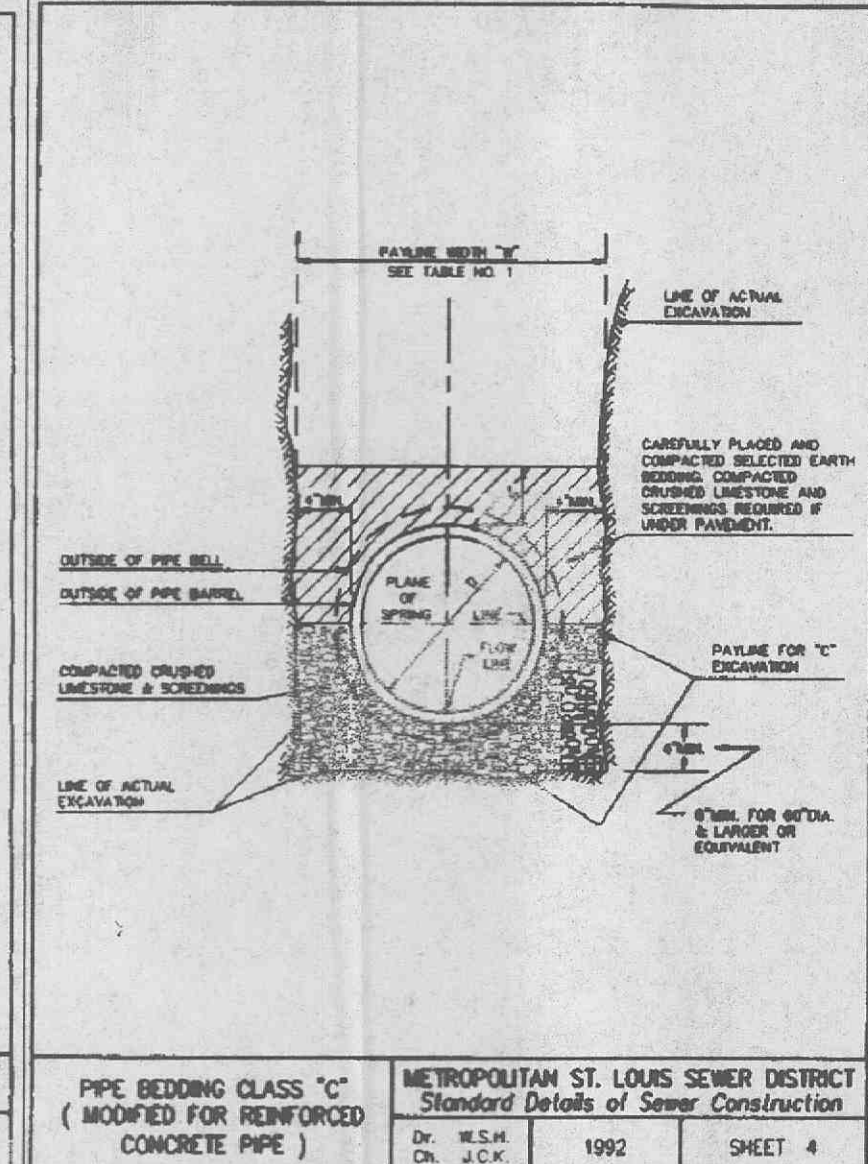

PIPE BEDDING CLASS "C" (MODIFIED FOR REINFORCED CONCRETE PIPE)
 METROPOLITAN ST. LOUIS SEWER DISTRICT Standard Details of Sewer Construction
 Dr. W.S.H. Ch. J.C.K. 1992 SHEET 4

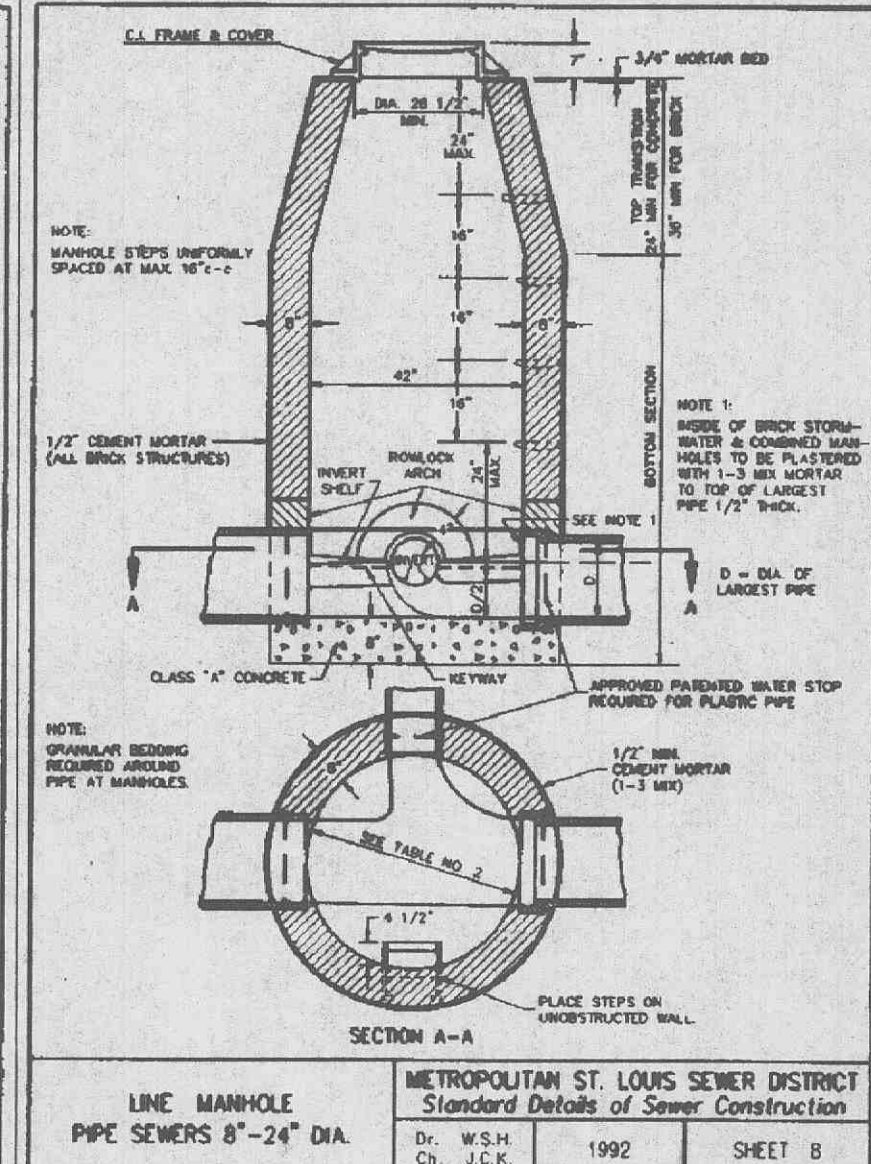

LINE MANHOLE PIPE SEWERS 8"-24" DIA.
 METROPOLITAN ST. LOUIS SEWER DISTRICT Standard Details of Sewer Construction
 Dr. W.S.H. Ch. J.C.K. 1992 SHEET 8

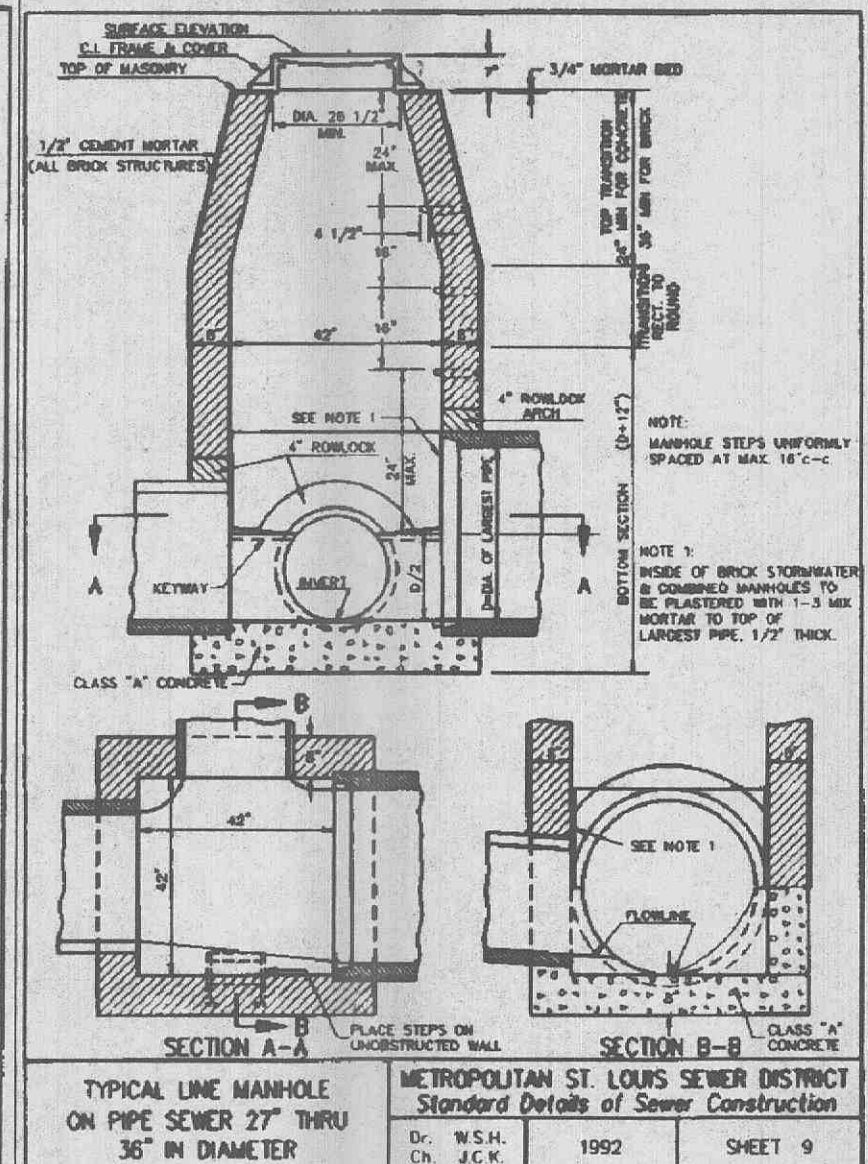

TYPICAL LINE MANHOLE ON PIPE SEWER 27" THRU 36" IN DIAMETER
 METROPOLITAN ST. LOUIS SEWER DISTRICT Standard Details of Sewer Construction
 Dr. W.S.H. Ch. J.C.K. 1992 SHEET 9

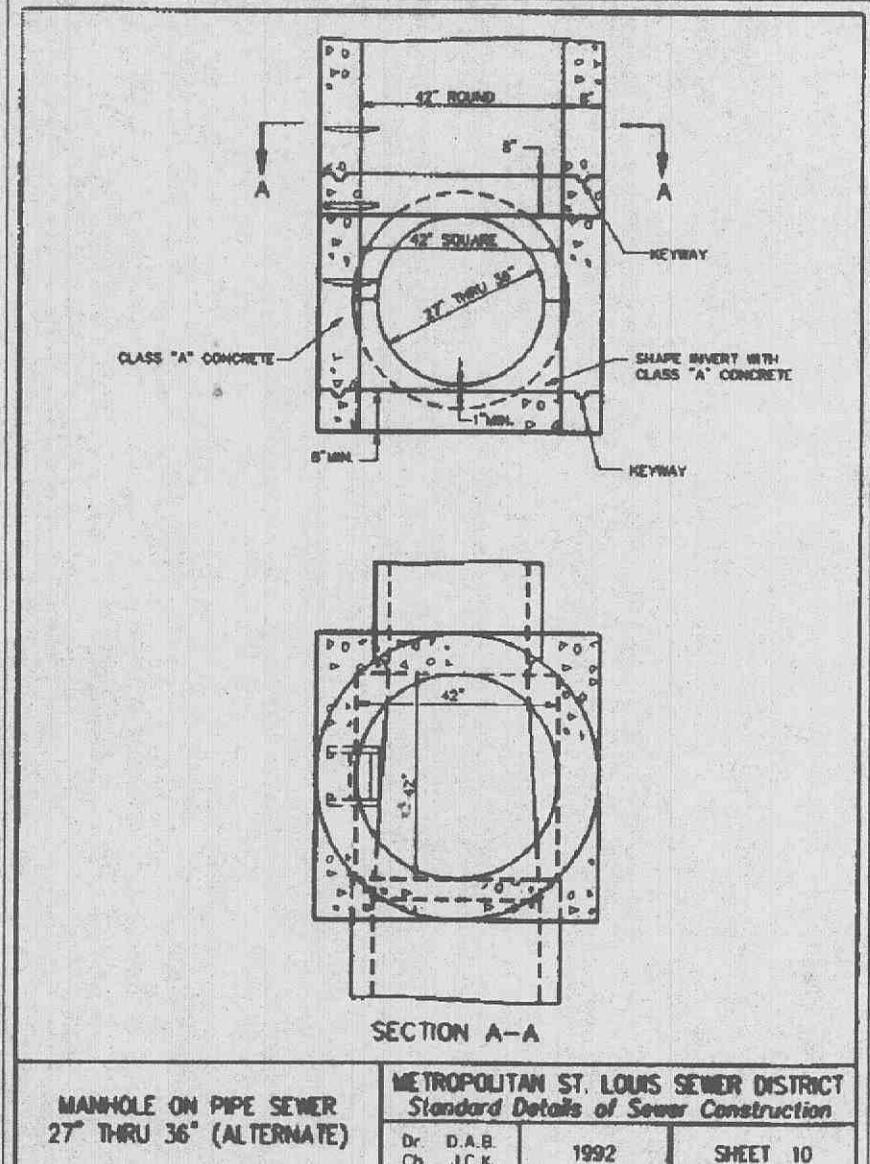

MANHOLE ON PIPE SEWER 27" THRU 36" (ALTERNATE)
 METROPOLITAN ST. LOUIS SEWER DISTRICT Standard Details of Sewer Construction
 Dr. D.A.B. Ch. J.C.K. 1992 SHEET 10

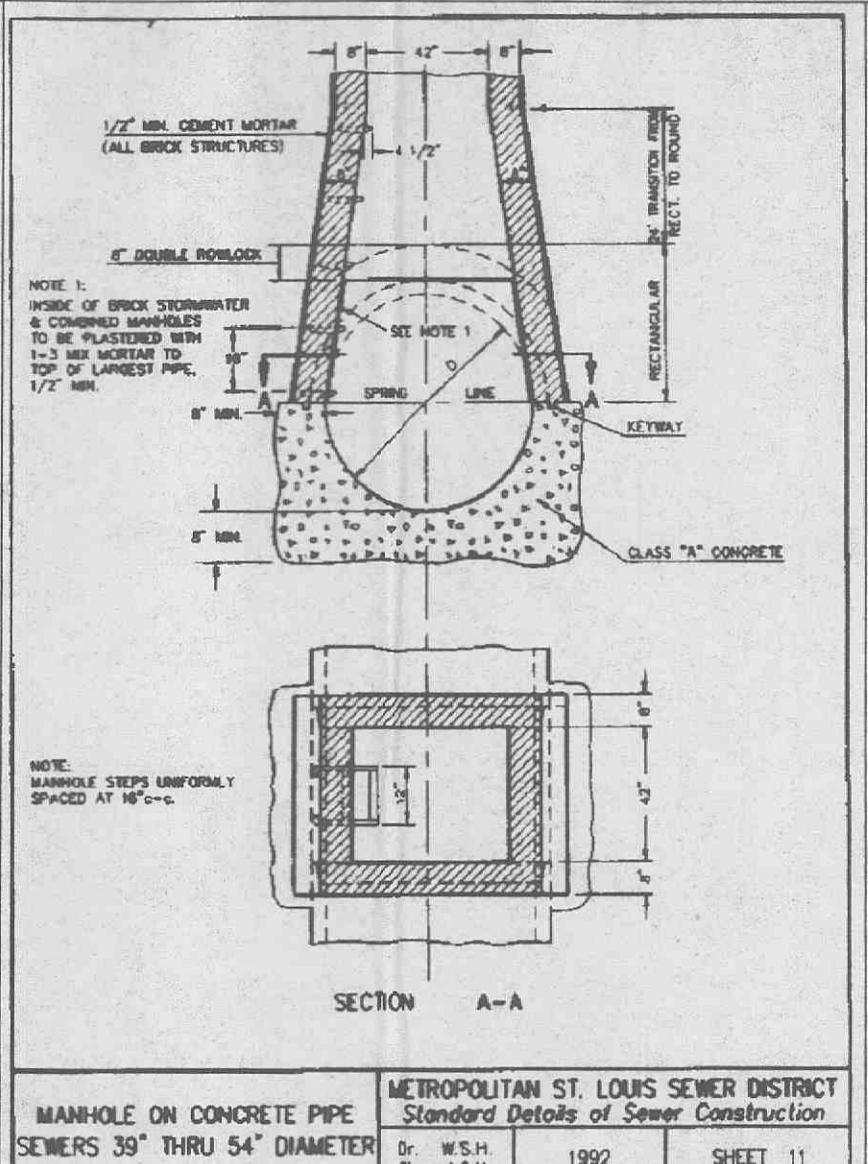

MANHOLE ON CONCRETE PIPE SEWERS 39" THRU 54" DIAMETER
 METROPOLITAN ST. LOUIS SEWER DISTRICT Standard Details of Sewer Construction
 Dr. W.S.H. Ch. J.C.K. 1992 SHEET 11

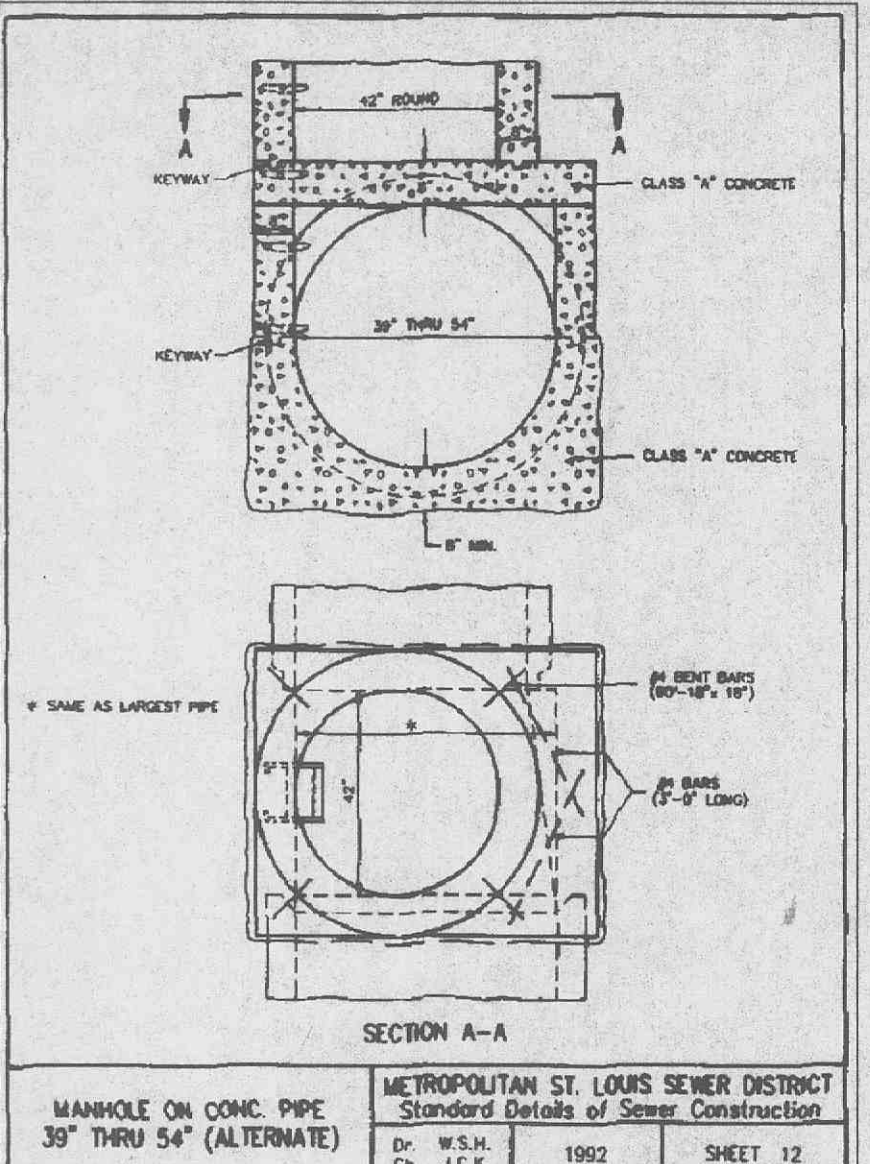

MANHOLE ON CONC. PIPE 39" THRU 54" (ALTERNATE)
 METROPOLITAN ST. LOUIS SEWER DISTRICT Standard Details of Sewer Construction
 Dr. W.S.H. Ch. J.C.K. 1992 SHEET 12

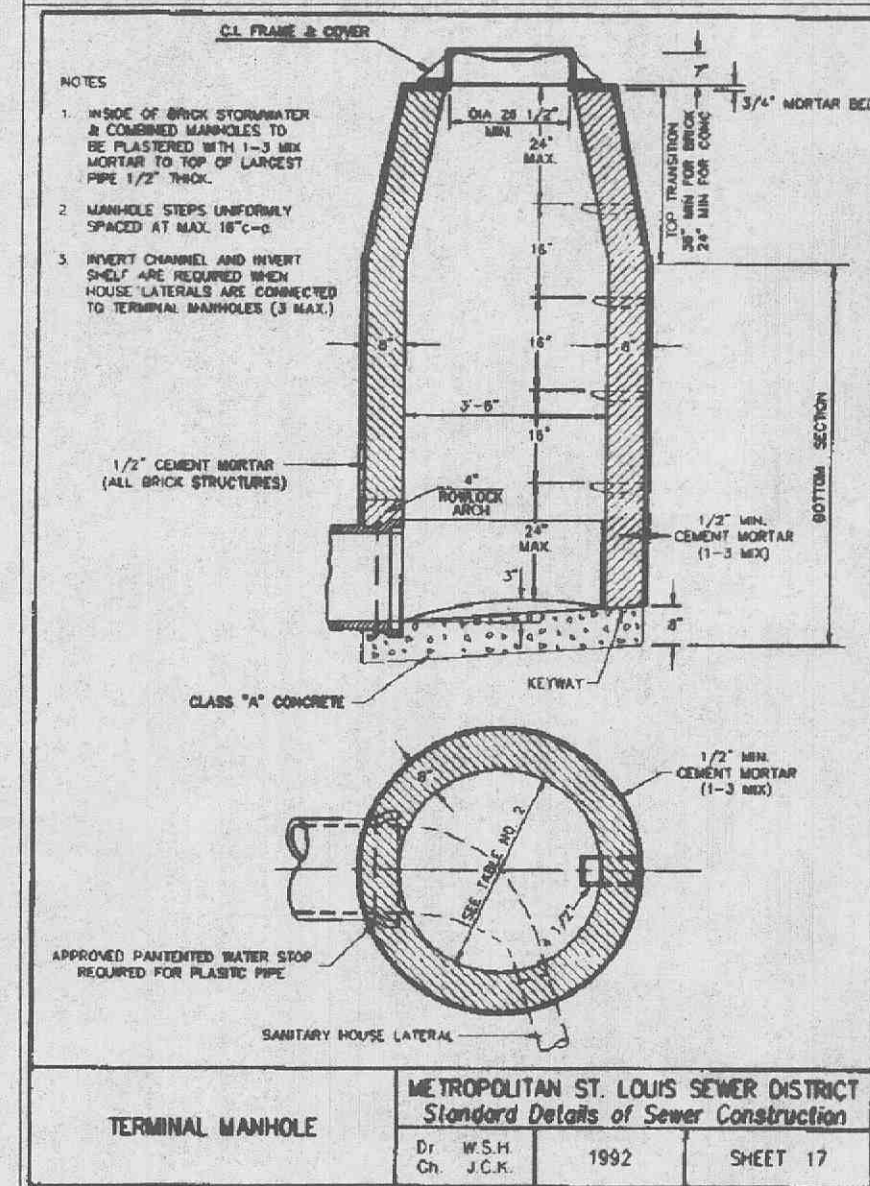

TERMINAL MANHOLE
 METROPOLITAN ST. LOUIS SEWER DISTRICT Standard Details of Sewer Construction
 Dr. W.S.H. Ch. J.C.K. 1992 SHEET 17

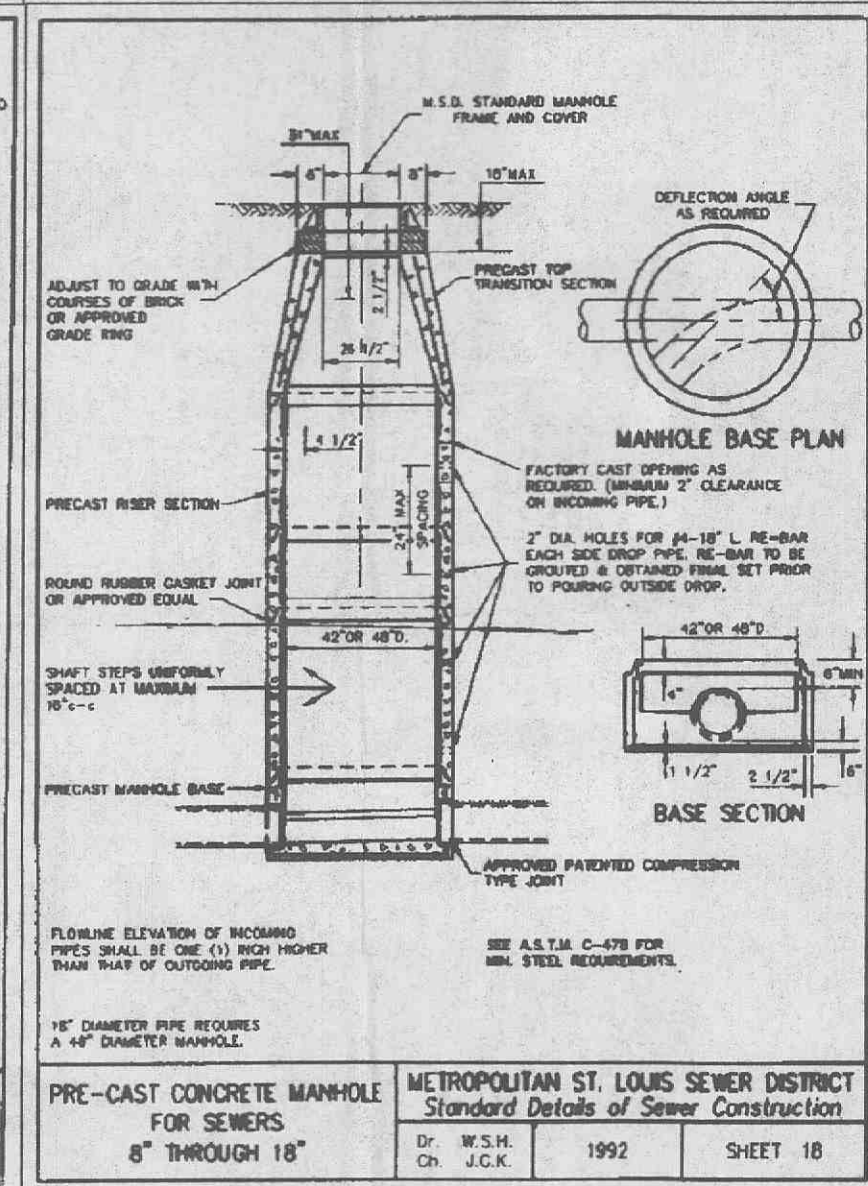

PRE-CAST CONCRETE MANHOLE FOR SEWERS 8" THROUGH 18"
 METROPOLITAN ST. LOUIS SEWER DISTRICT Standard Details of Sewer Construction
 Dr. W.S.H. Ch. J.C.K. 1992 SHEET 18

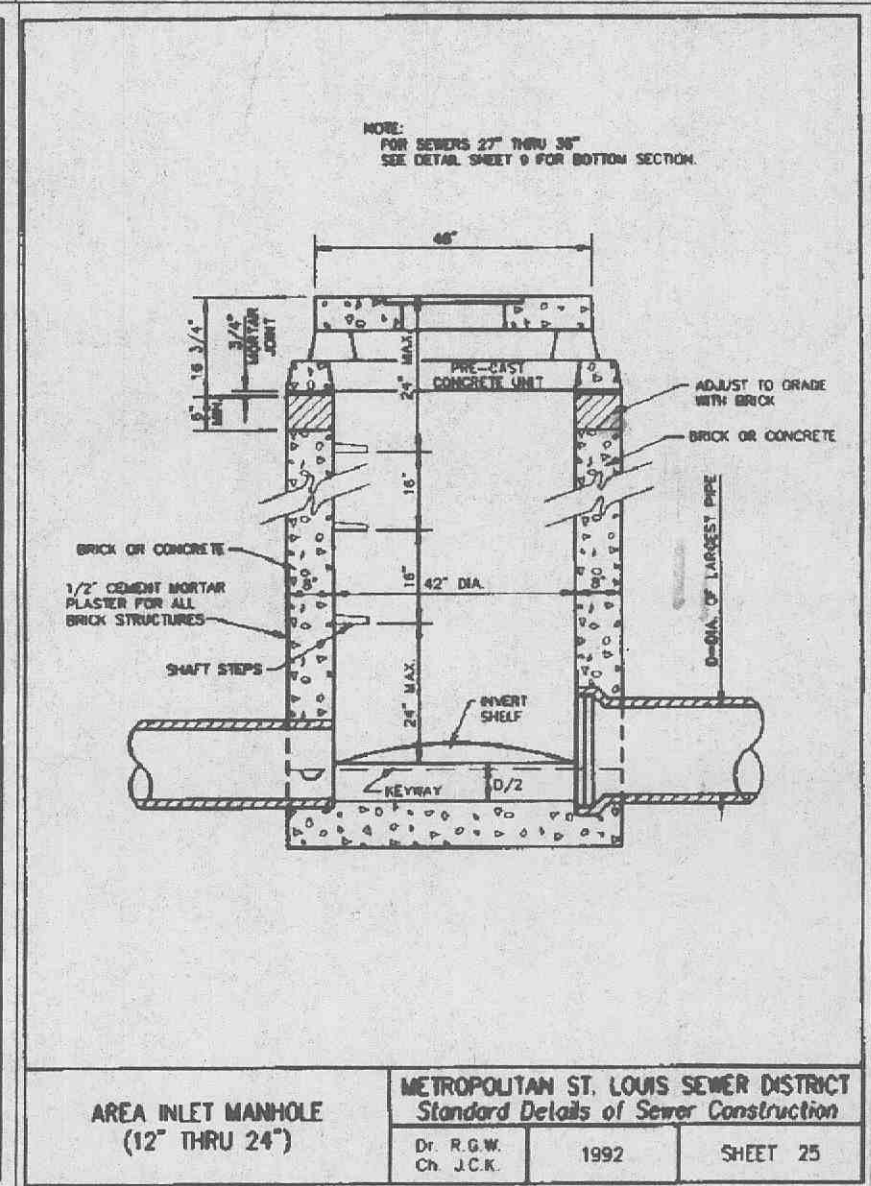

AREA INLET MANHOLE (12" THRU 24")
 METROPOLITAN ST. LOUIS SEWER DISTRICT Standard Details of Sewer Construction
 Dr. R.G.W. Ch. J.C.K. 1992 SHEET 25

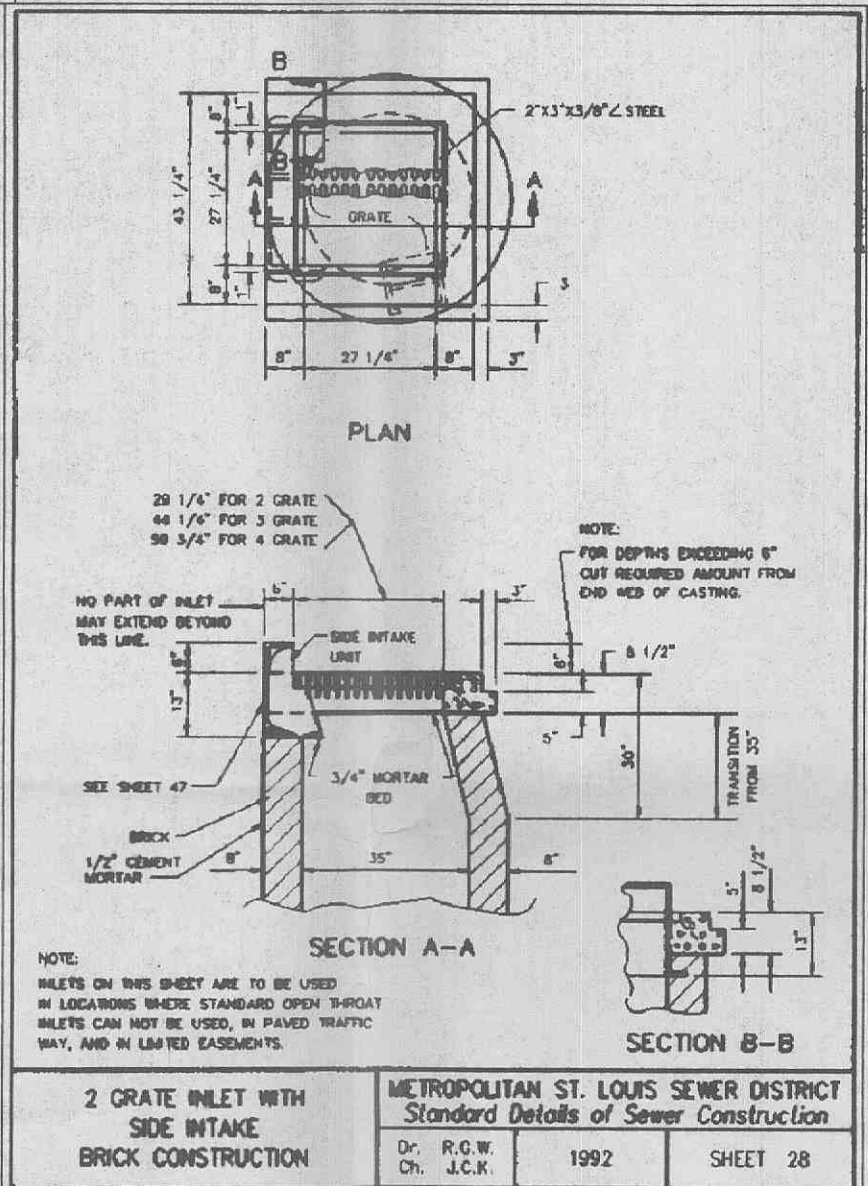

2 GRATE INLET WITH SIDE INTAKE BRICK CONSTRUCTION
 METROPOLITAN ST. LOUIS SEWER DISTRICT Standard Details of Sewer Construction
 Dr. R.G.W. Ch. J.C.K. 1992 SHEET 28

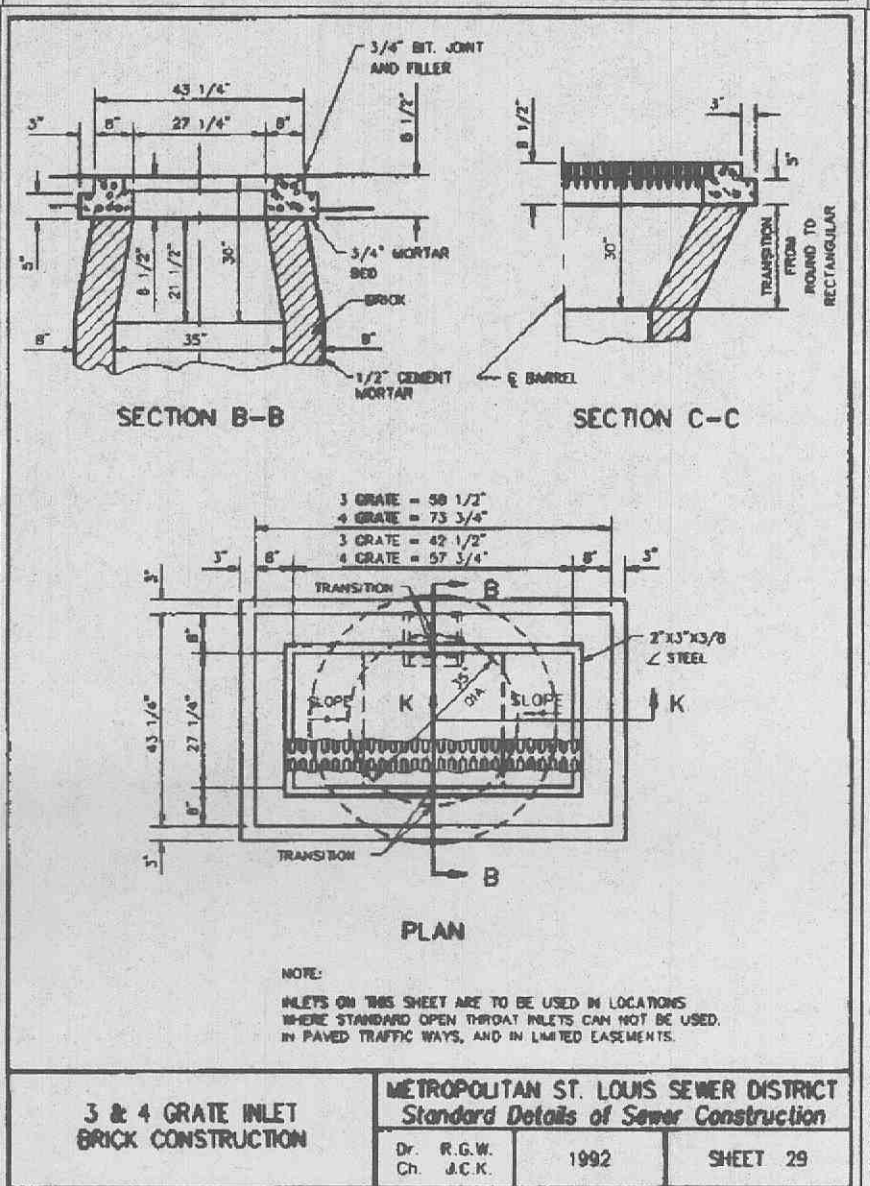

3 & 4 GRATE INLET BRICK CONSTRUCTION
 METROPOLITAN ST. LOUIS SEWER DISTRICT Standard Details of Sewer Construction
 Dr. R.G.W. Ch. J.C.K. 1992 SHEET 29

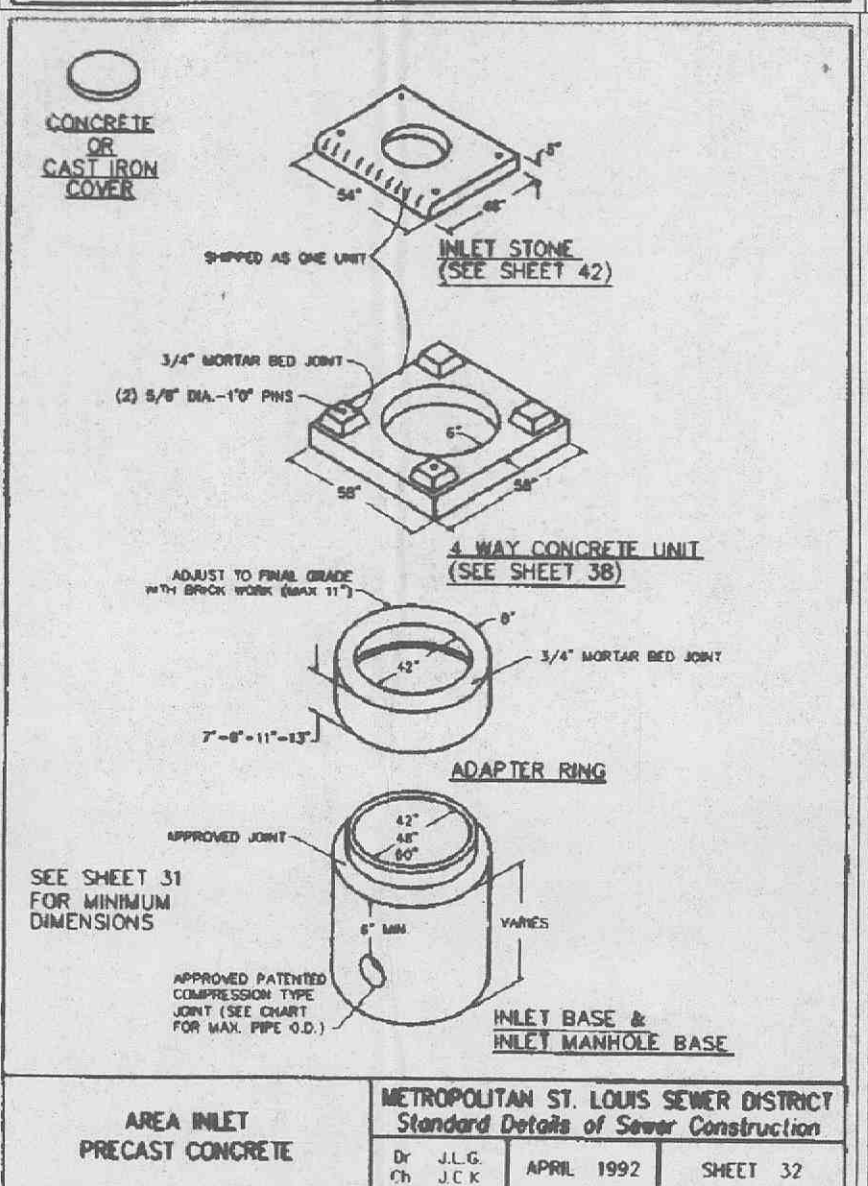

AREA INLET PRECAST CONCRETE
 METROPOLITAN ST. LOUIS SEWER DISTRICT Standard Details of Sewer Construction
 Dr. J.L.G. Ch. J.C.K. APRIL 1992 SHEET 32

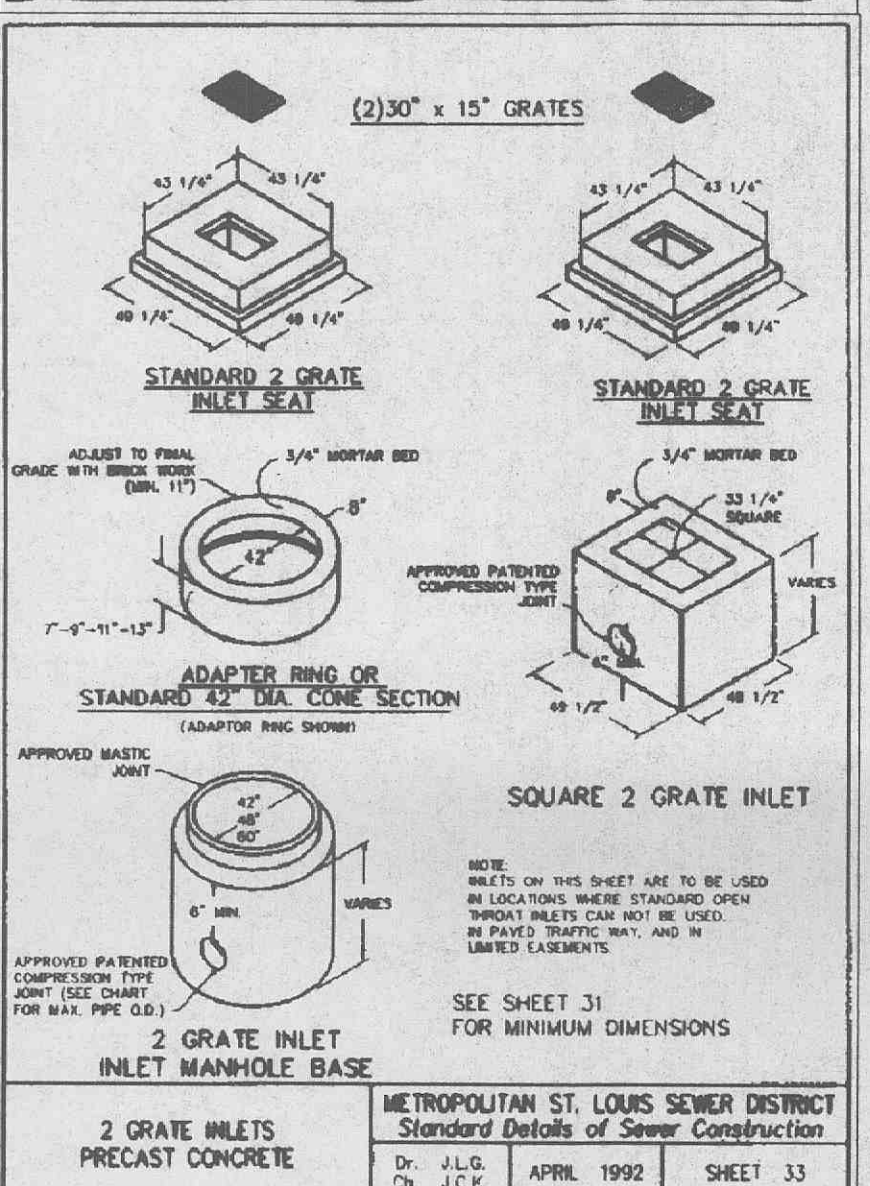

2 GRATE INLETS PRECAST CONCRETE
 METROPOLITAN ST. LOUIS SEWER DISTRICT Standard Details of Sewer Construction
 Dr. J.L.G. Ch. J.C.K. APRIL 1992 SHEET 33

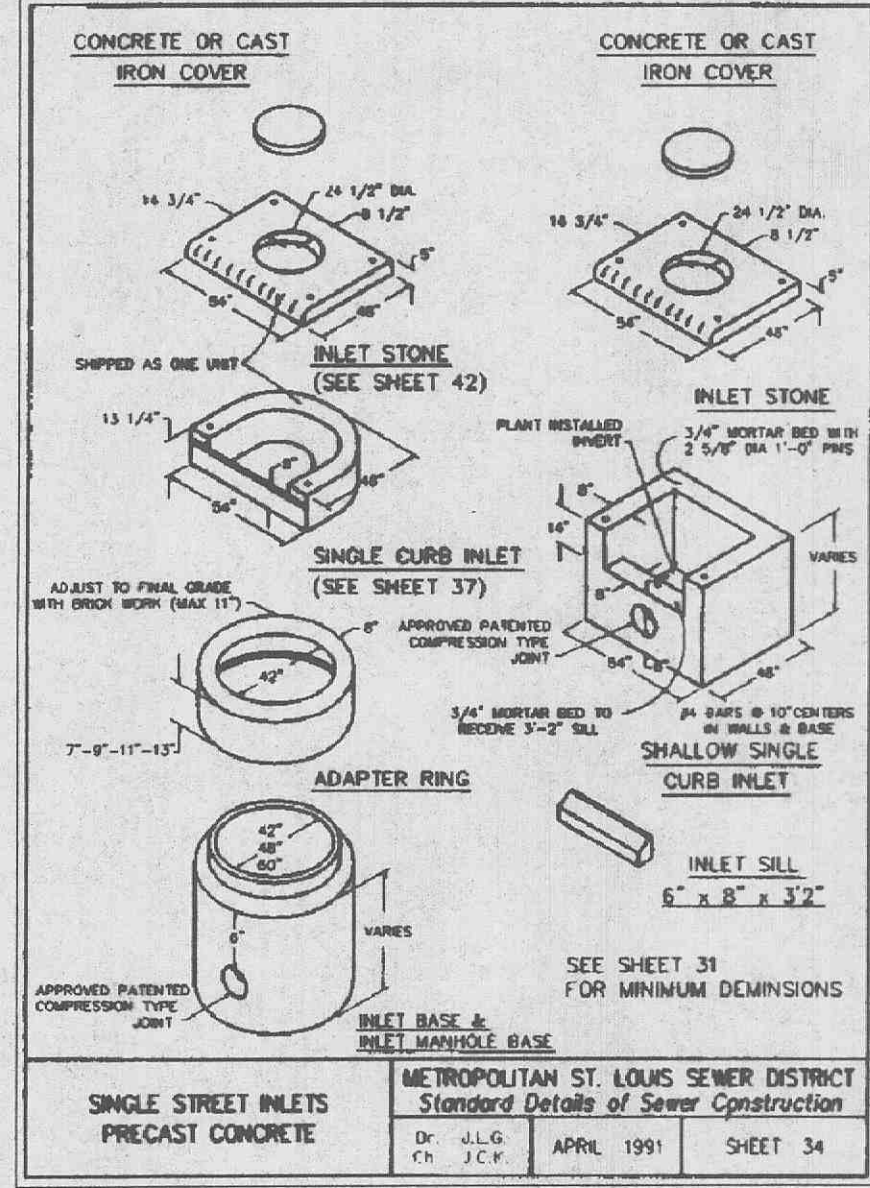

SINGLE STREET INLETS PRECAST CONCRETE
 METROPOLITAN ST. LOUIS SEWER DISTRICT Standard Details of Sewer Construction
 Dr. J.L.G. Ch. J.C.K. APRIL 1991 SHEET 34

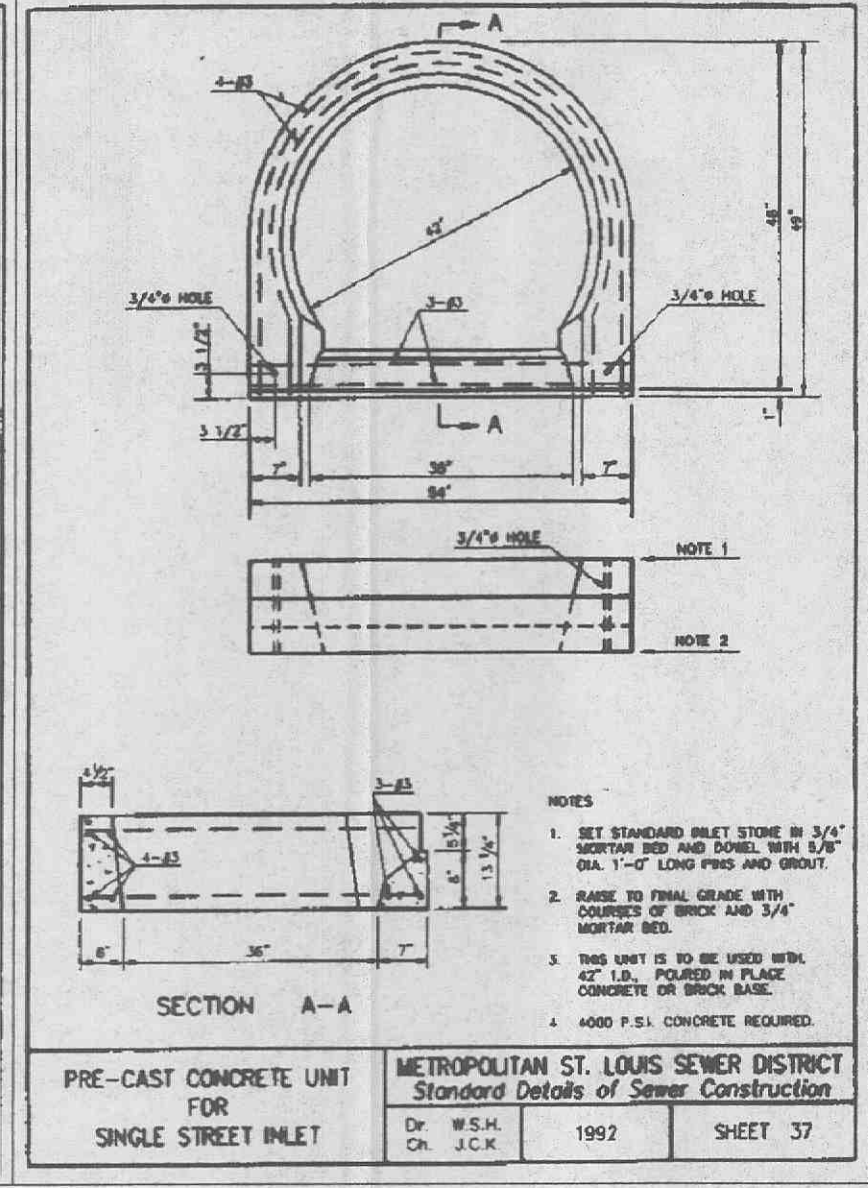

PRE-CAST CONCRETE UNIT FOR SINGLE STREET INLET
 METROPOLITAN ST. LOUIS SEWER DISTRICT Standard Details of Sewer Construction
 Dr. W.S.H. Ch. J.C.K. 1992 SHEET 37

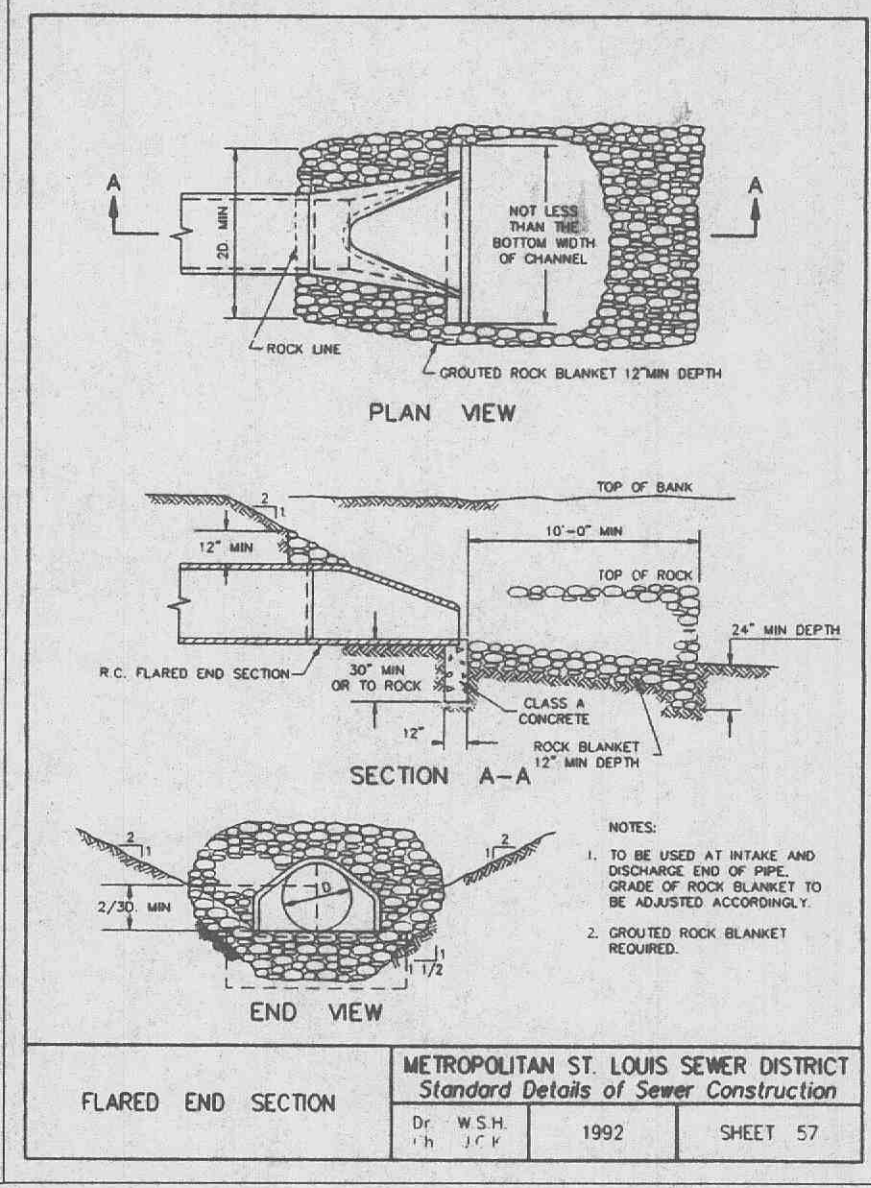

FLARED END SECTION
 METROPOLITAN ST. LOUIS SEWER DISTRICT Standard Details of Sewer Construction
 Dr. W.S.H. Ch. J.C.K. 1992 SHEET 57