

8657-X-160048  
 REVISIONS  
 DATE: 03/29/02  
 FIRST ISSUE

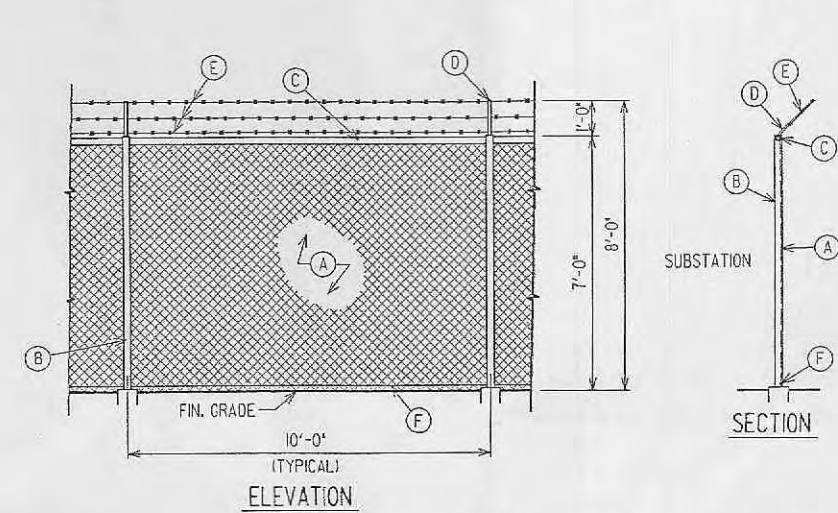

- A CHAINLINK FABRIC - #9 GALV. STEEL WIRE, WHEN IN 2" MESH, W/ A CLASS FALCON COATING
- B LINE POST - 2" X 2" GALV. STEEL PIPE
- C TOP RAIL - 1/2" O.D. GALV. STEEL PIPE
- D EXTENSION ARM - WORN TO CARRY 3 STRANDS OF BANDED WIRE, 48" TO OUTSIDE
- E BANDED WIRE - COPPERWELDED STEEL CO. ALUMINUM OR FOUR POINT DIA TYPE LIGHT WEIGHT
- F BOTTOM TENSION WIRE - #7 GALV. ALUMINUM COATED SPRING WIRE OR CRAMPED WIRE

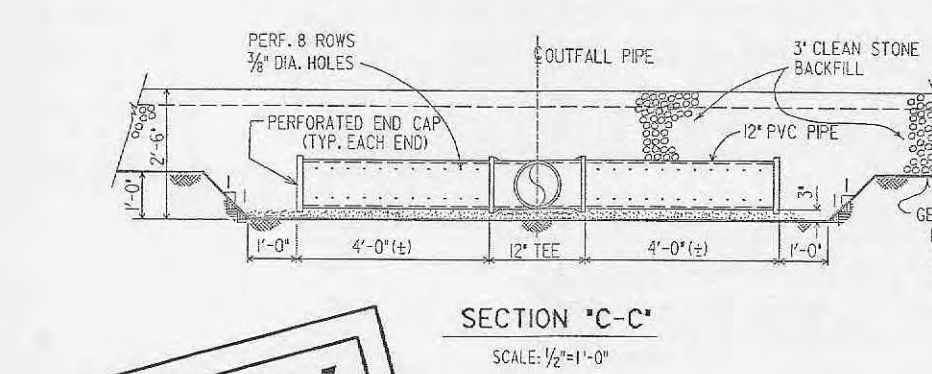
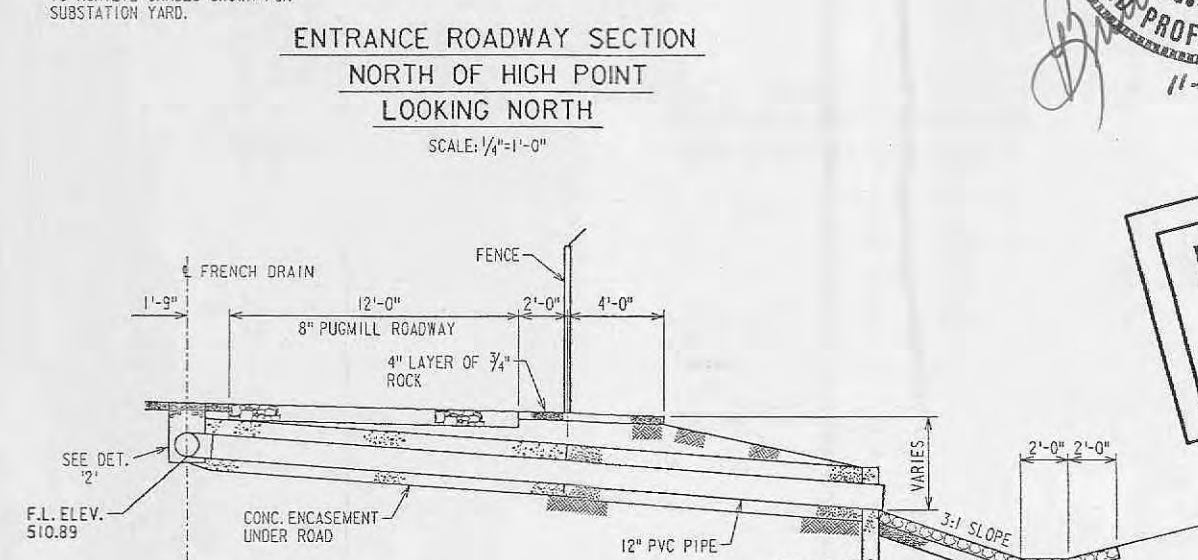
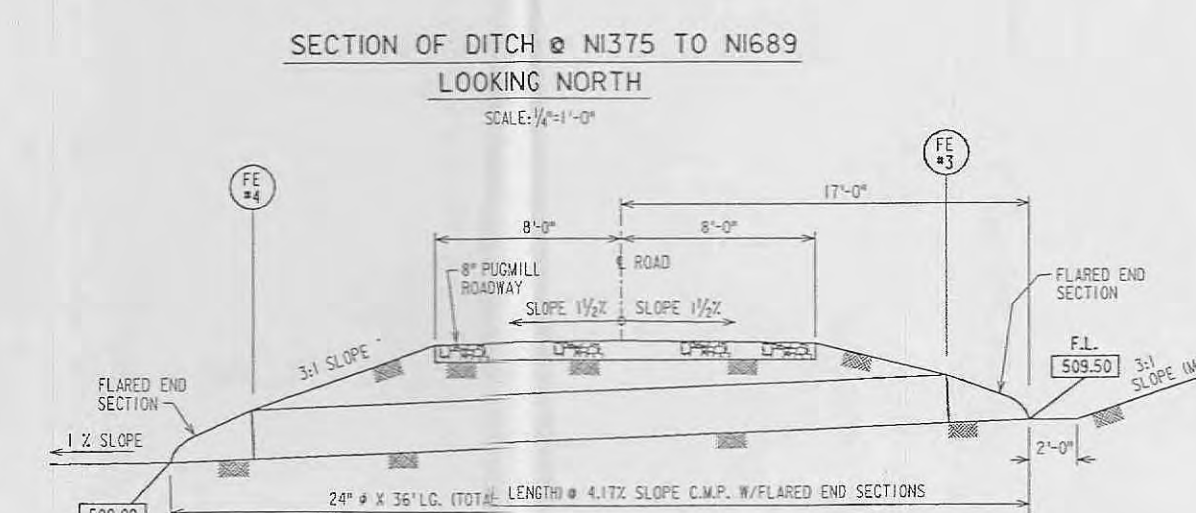
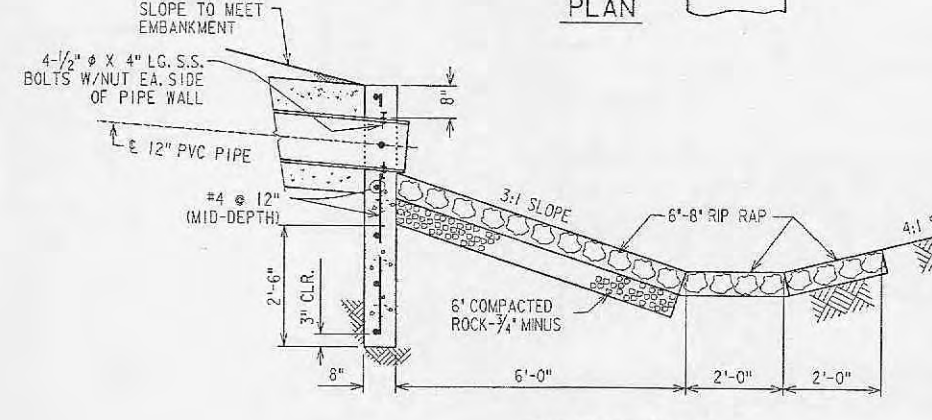
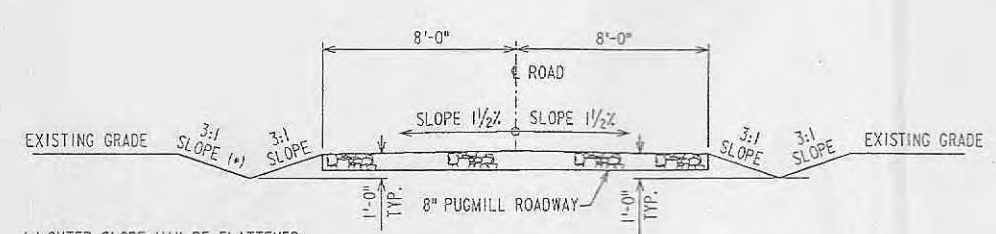
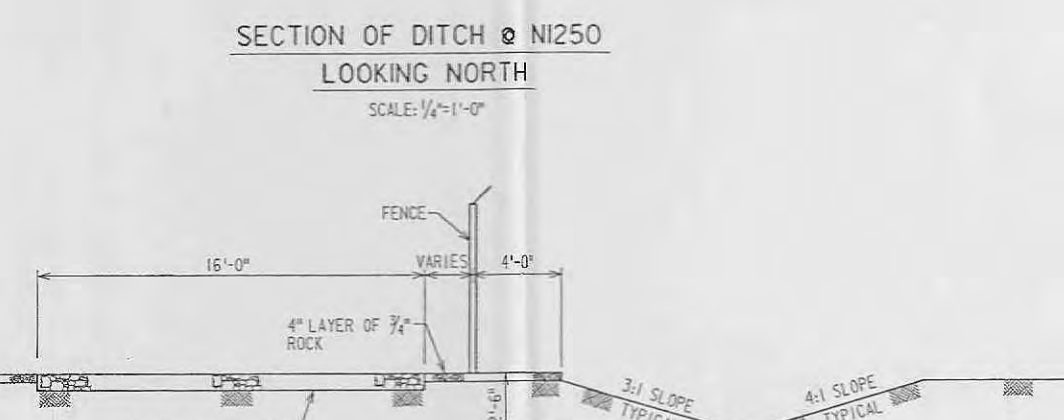
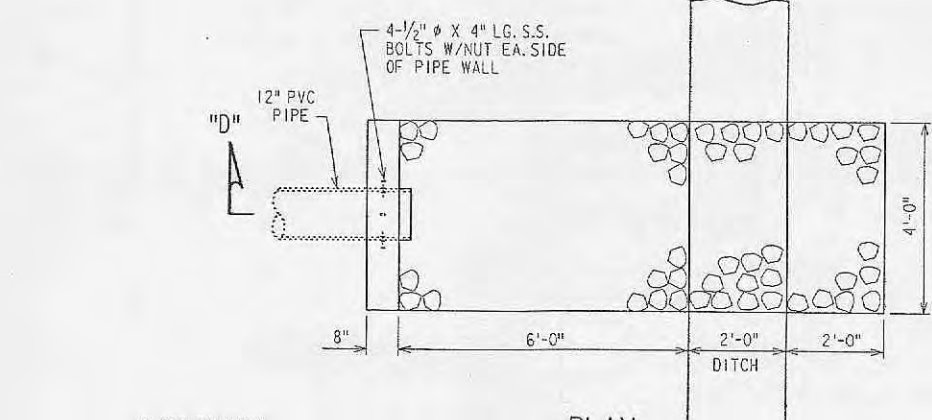
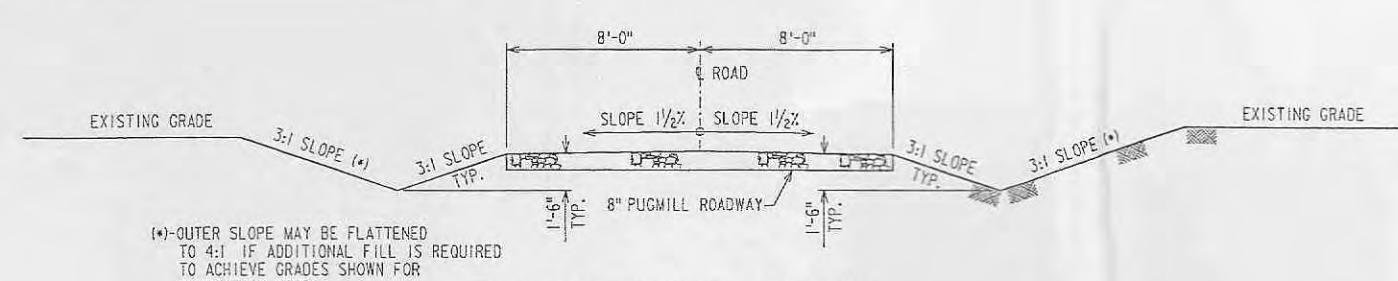
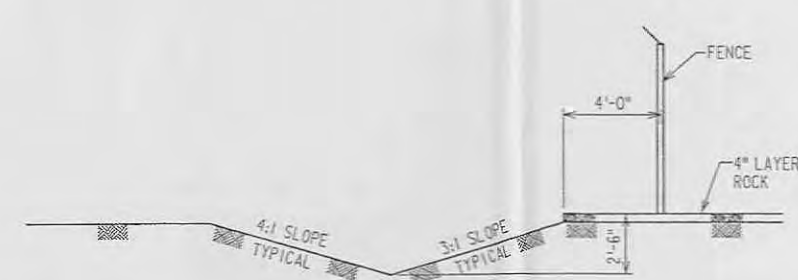
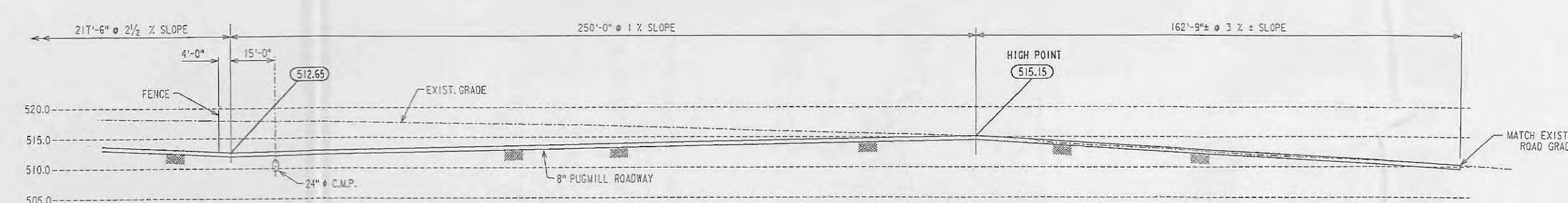
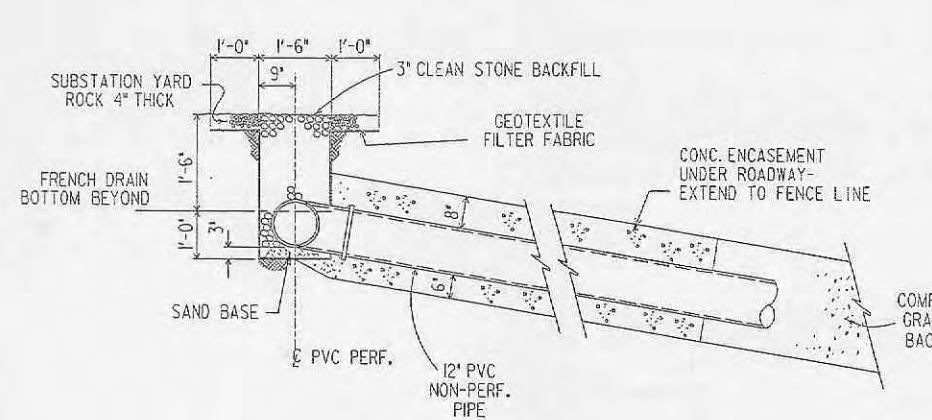
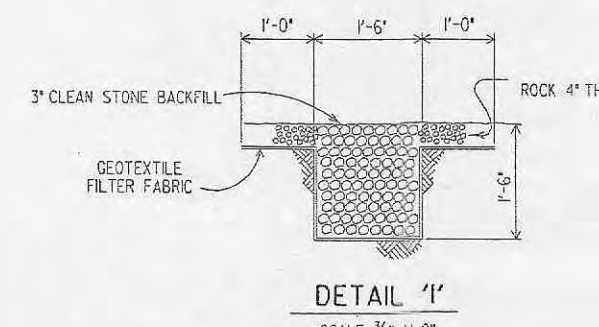
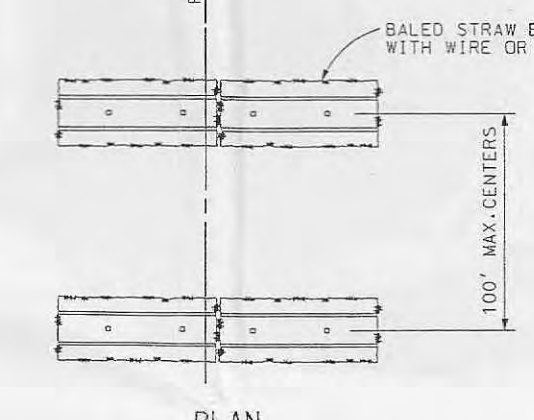
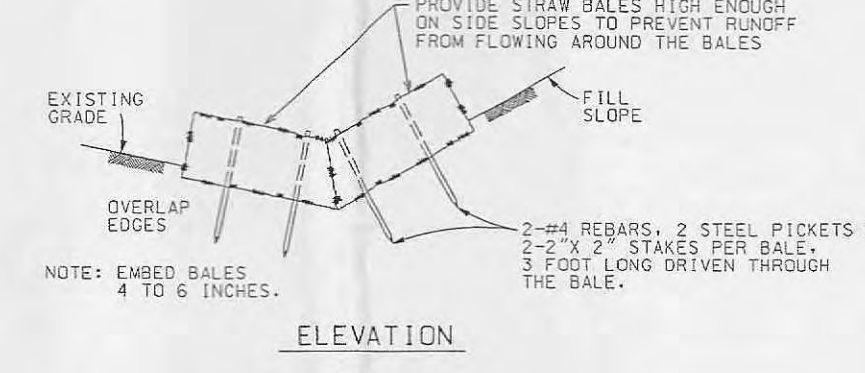
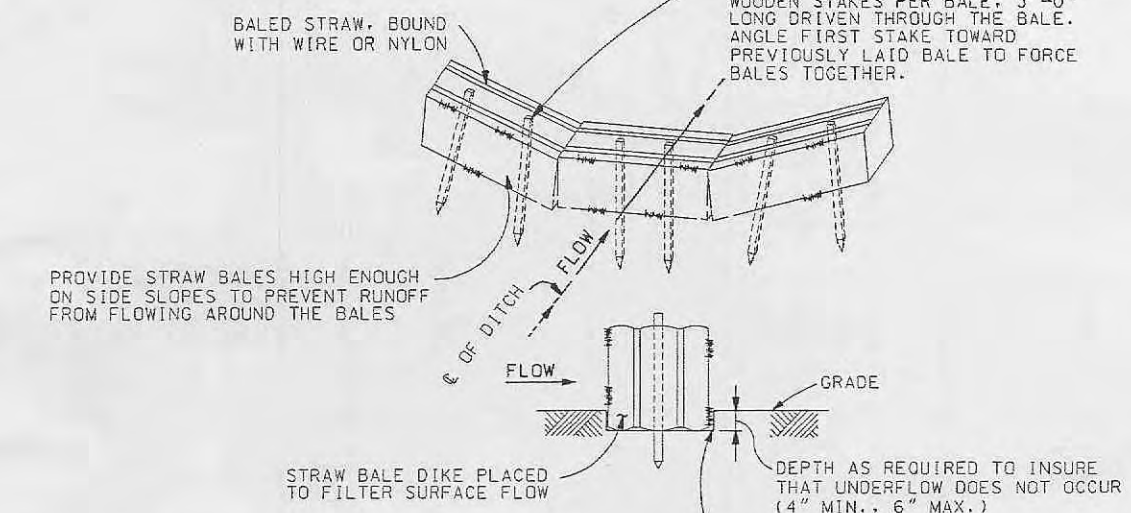
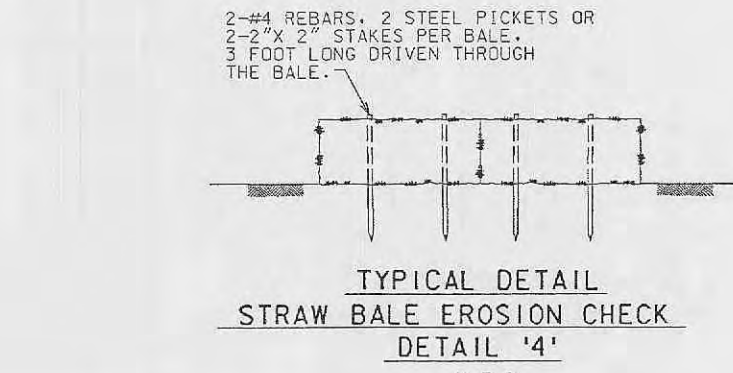

**PRELIMINARY  
 NOT FOR CONSTRUCTION**

PROPERTY PLAN GRADING & SURFACING ACCESS ROAD - 8657-X-52623  
 PROPERTY PLAN GRADING, ROADWAY, SURFACING AND FENCE - 8657-X-99853

DATE: 03/29/02	PROJECT: BELLEAU SUBSTATION EXPANSION
DRAWN: [Signature]	CHECKED: [Signature]
SCALE: 1/2"=1'-0"	DATE: 03/29/02
PROJECT: BELLEAU SUBSTATION EXPANSION	DATE: 03/29/02
PROJECT: BELLEAU SUBSTATION EXPANSION	DATE: 03/29/02