

ROUND PIPE				HORIZONTAL ELLIPTICAL PIPE			
INSIDE DIAMETER OF PIPE (INCHES)	"W" PAYLINE WIDTH OF TRENCH (INCHES)	"M" PAYLINE WIDTH OF TRENCH (FEET)	PAY-VOLUMES (CU YD PER FT)	INSIDE DIMENSIONS OF PIPE (INCHES)	"W" PAYLINE WIDTH OF TRENCH (INCHES)	"M" PAYLINE WIDTH OF TRENCH (FEET)	PAY-VOLUMES (CU YD PER FT)
4	30	2.50	3.28				
6	30	2.50	3.59				
8	30	2.50	3.87				
10	30	2.50	4.09				
12	30	2.50	4.25				
15	36	3.00	5.55				
18	36	3.00	5.77	14 x 23	41	3.42	5.94
21	39	3.25	6.61				
24	42	3.50	7.39	19 x 30	49	4.08	7.88
27	45	3.75	8.18	22 x 34	53	4.42	8.81
30	49	4.08	9.30	24 x 38	58	4.83	9.70
33	53	4.42	10.53	27 x 42	62	5.17	10.71
36	56	4.87	11.43	29 x 45	66	5.50	11.72
DISCONTINUED							
39	63	5.29	13.38	34 x 53	75	6.25	14.05
48	70	5.83	15.87	38 x 60	83	6.82	16.16
54	77	6.42	18.13	43 x 68	92	7.67	18.86
60	84	7.00	20.73	48 x 76	101	8.42	21.58
66	91	7.58	23.45	53 x 83	109	9.08	24.35
72	98	8.17	26.37	58 x 91	118	9.83	27.45
78	105	8.75	29.39	63 x 98	126	10.50	30.50
84	112	9.33	32.57	68 x 106	135	11.25	33.81
90	119	9.92	35.90	72 x 113	143	11.92	36.99
96	126	10.50	39.37	77 x 121	152	12.67	40.89
102	133	11.08	42.99	82 x 128	160	13.33	44.45
108	140	11.67	46.75	87 x 136	168	14.00	47.79
114	147	12.25	50.66	92 x 143	176	14.67	51.70
120	154	12.83	54.73	97 x 151	185	15.42	56.01
126	161	13.42	58.92				
132	168	14.00	63.27	106 x 168	202	16.83	64.48
144	182	15.17	72.40	116 x 180	218	18.17	73.59

TABLE 1  
PAYLINE WIDTHS OF TRENCH AND PAY-QUANTITIES OF CONCRETE  
METROPOLITAN ST. LOUIS SEWER DISTRICT  
Standard Details of Sewer Construction  
Dr. B.E.B. Ch. J.C.K. 2000 SHEET 1

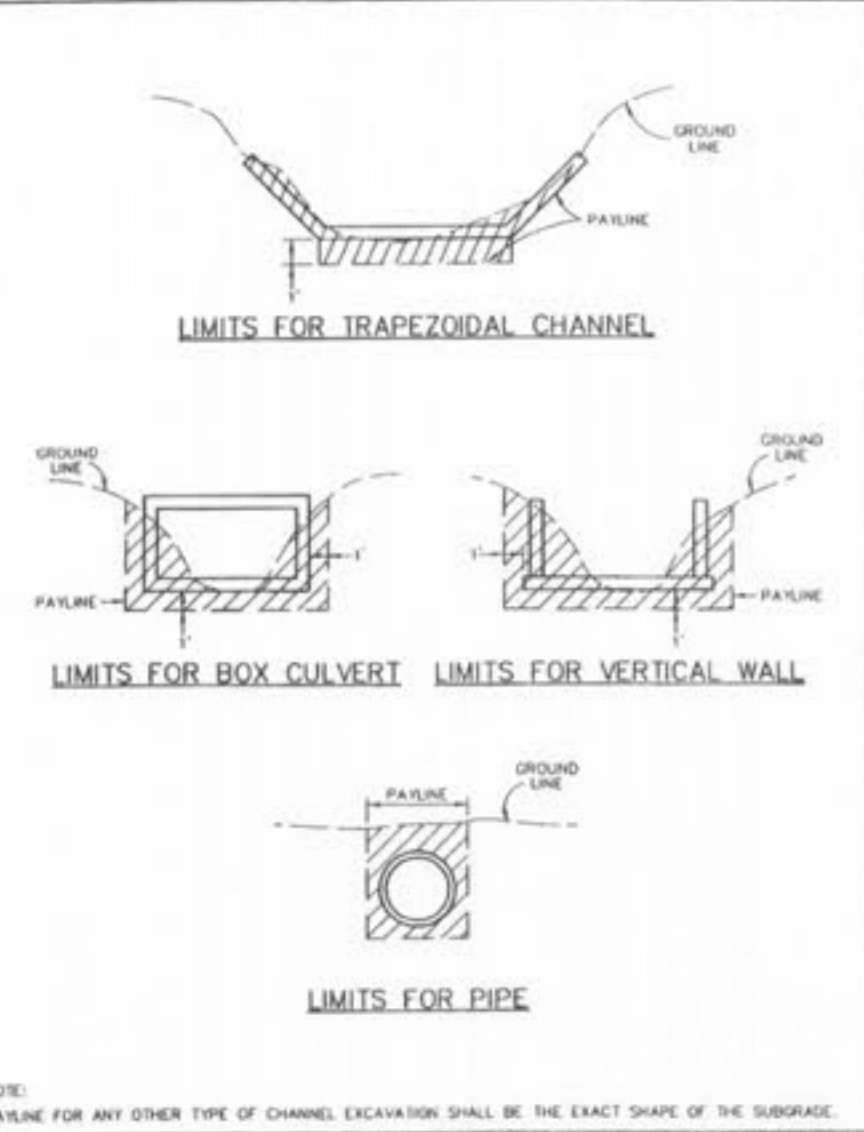

PAYLINE LIMITS FOR EXCAVATION  
METROPOLITAN ST. LOUIS SEWER DISTRICT  
Standard Details of Sewer Construction  
Dr. W.S.H. Ch. J.C.K. 2000 SHEET 2

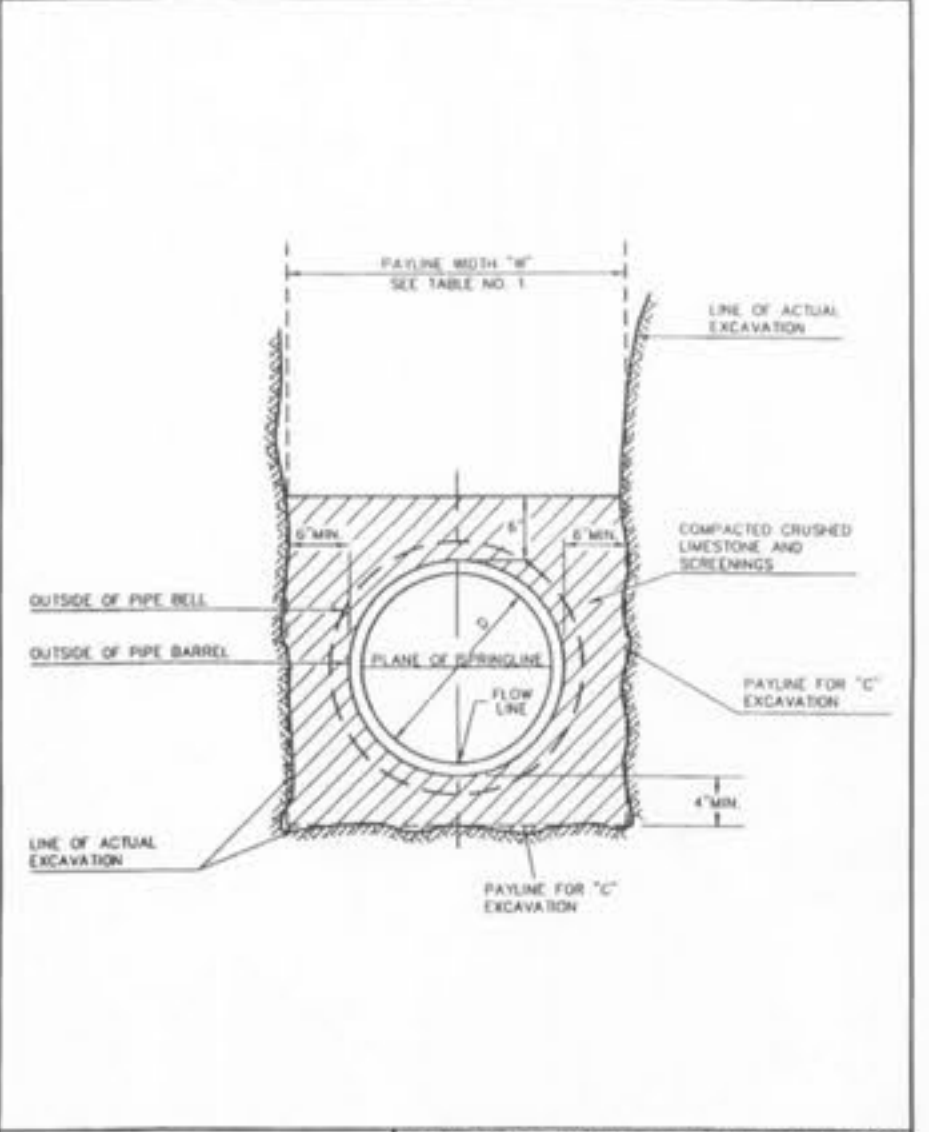

PIPE BEDDING CLASS "C"  
(MODIFIED FOR REINFORCED CONCRETE PIPE)  
METROPOLITAN ST. LOUIS SEWER DISTRICT  
Standard Details of Sewer Construction  
Dr. W.S.H. Ch. J.C.K. 2000 SHEET 4

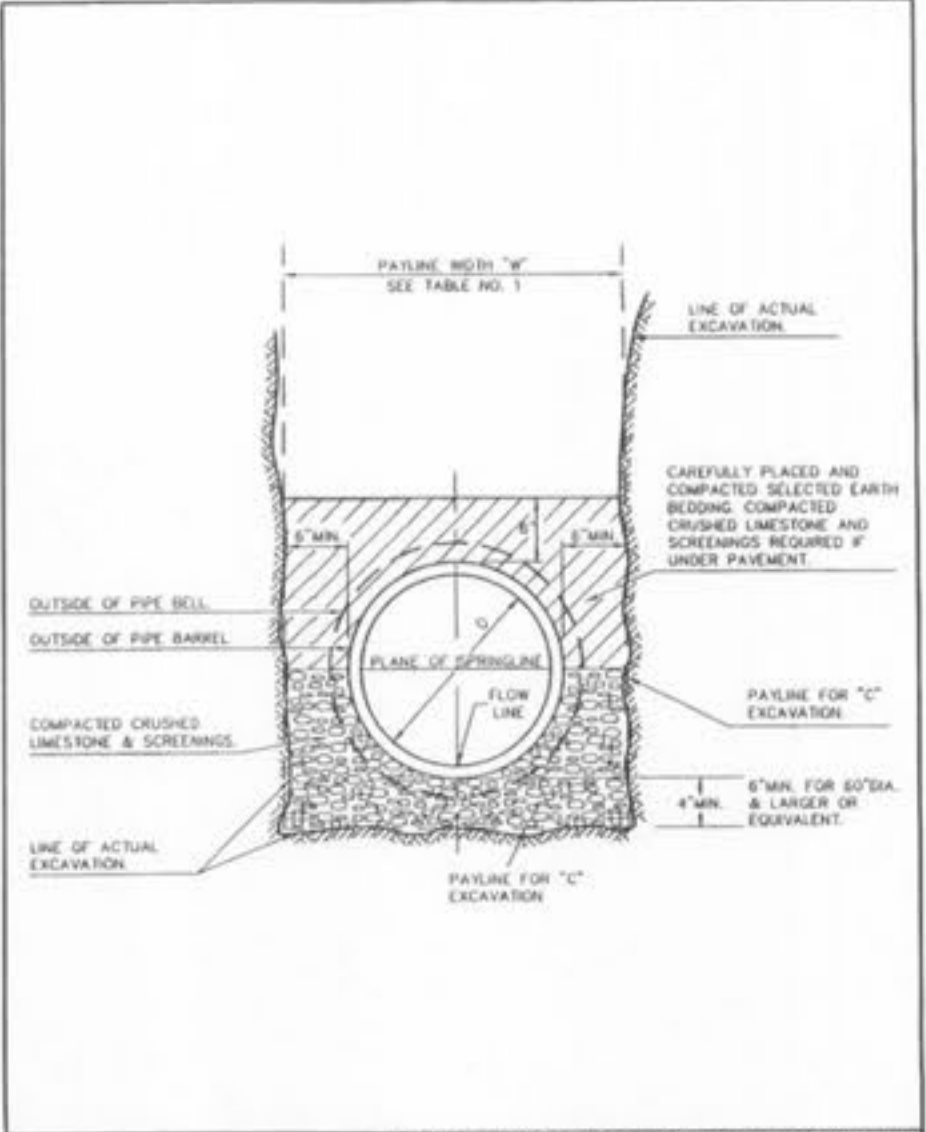

PIPE BEDDING CLASS "C"  
(MODIFIED FOR REINFORCED CONCRETE PIPE)  
METROPOLITAN ST. LOUIS SEWER DISTRICT  
Standard Details of Sewer Construction  
Dr. W.S.H. Ch. J.C.K. 2000 SHEET 5

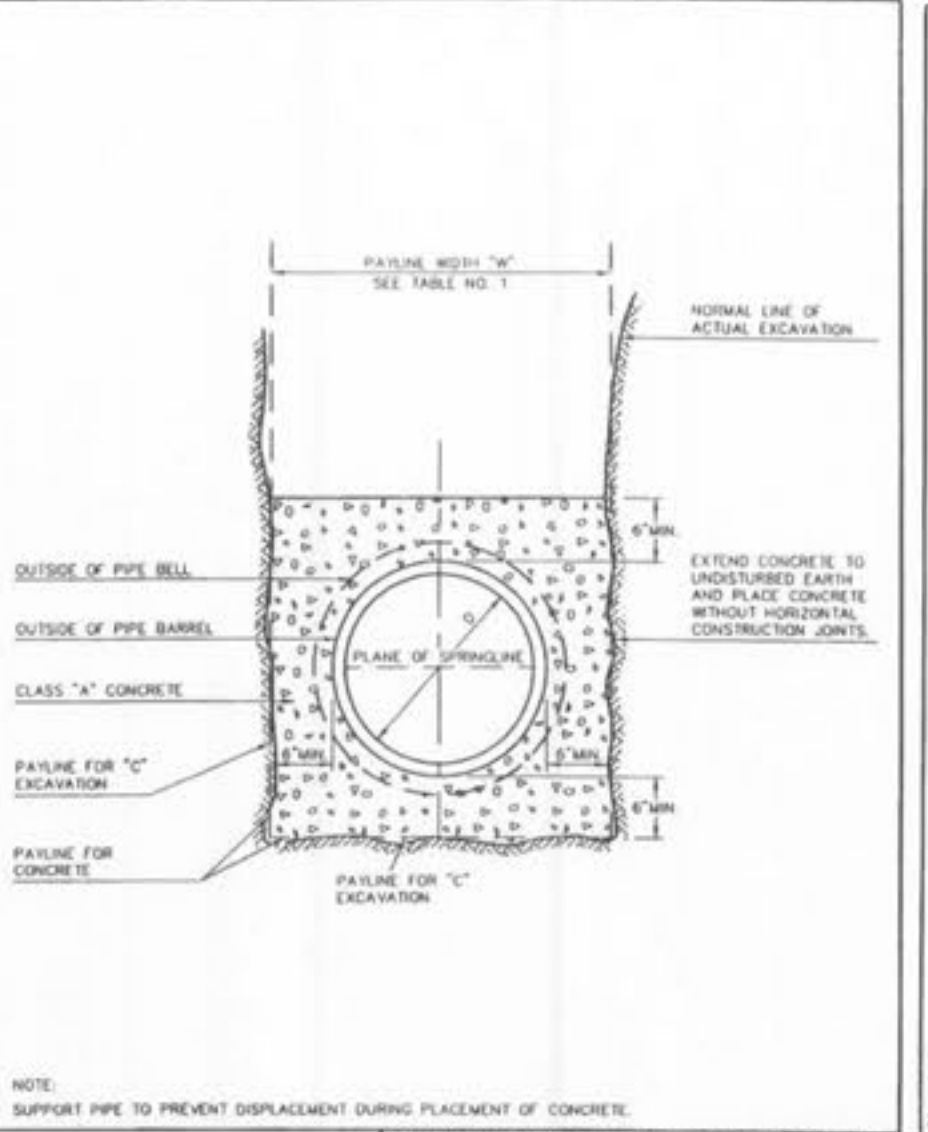

CONCRETE ENCASEMENT  
METROPOLITAN ST. LOUIS SEWER DISTRICT  
Standard Details of Sewer Construction  
Dr. W.S.H. Ch. J.C.K. 2000 SHEET 8

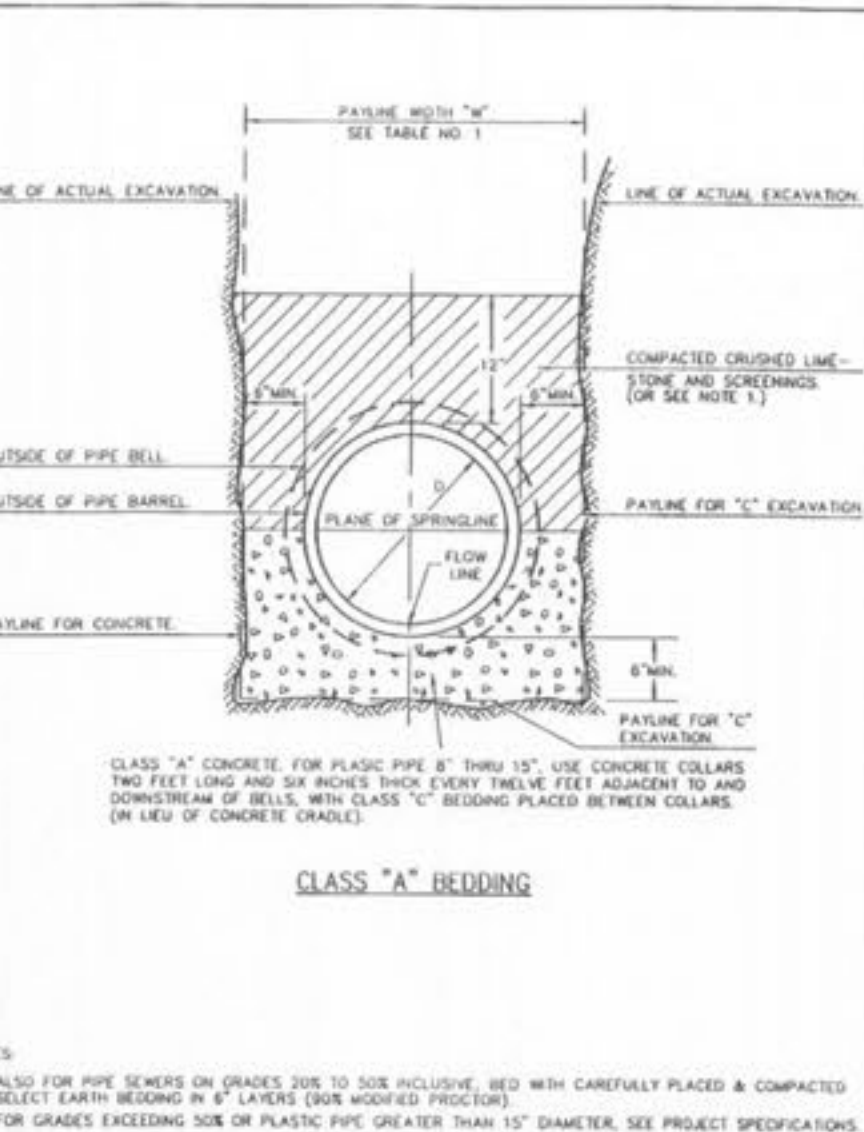

CONCRETE CRADLE  
METROPOLITAN ST. LOUIS SEWER DISTRICT  
Standard Details of Sewer Construction  
Dr. W.S.H./S.A.M. Ch. J.C.K. 2000 SHEET 9

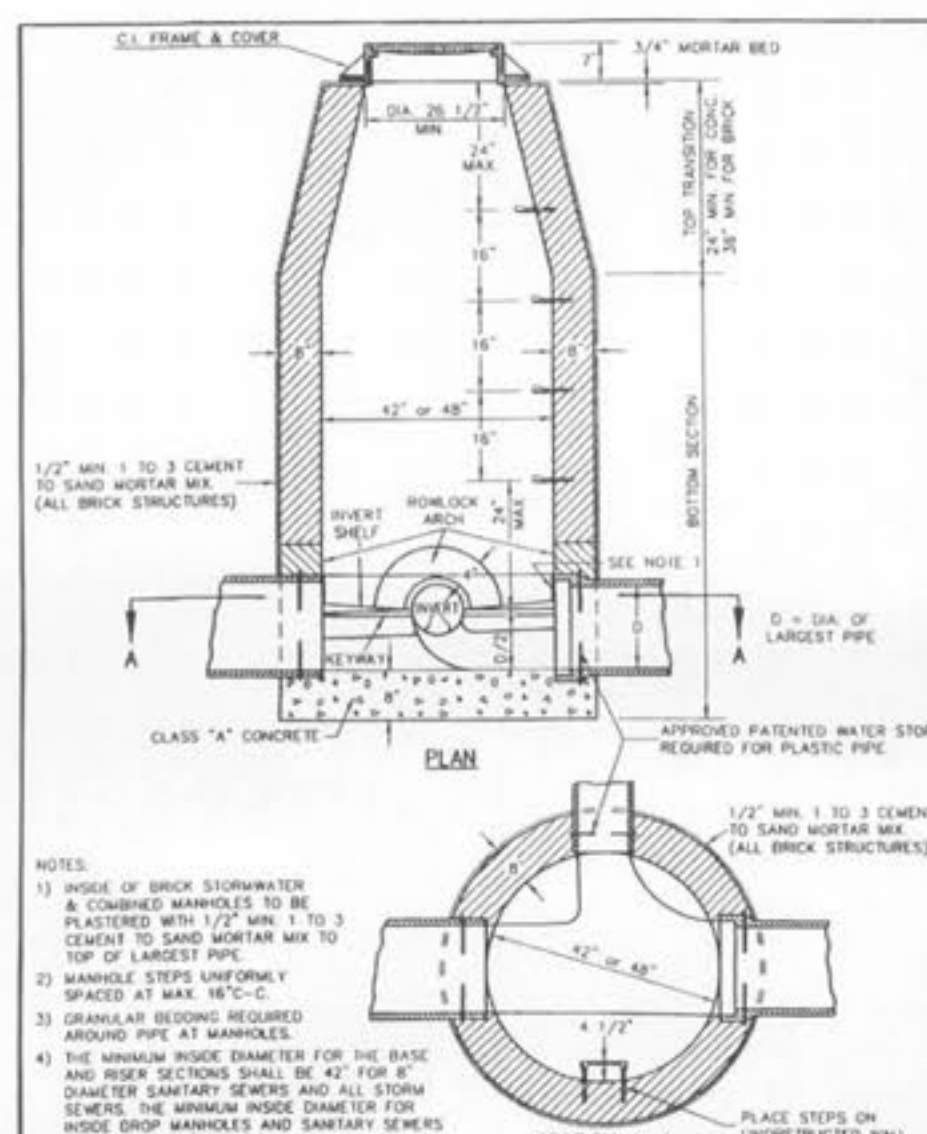

LINE MANHOLE ON PIPE SEWER 8"-24" DIA.  
METROPOLITAN ST. LOUIS SEWER DISTRICT  
Standard Details of Sewer Construction  
Dr. W.S.H./S.A.M. Ch. J.C.K. 2000 SHEET 10

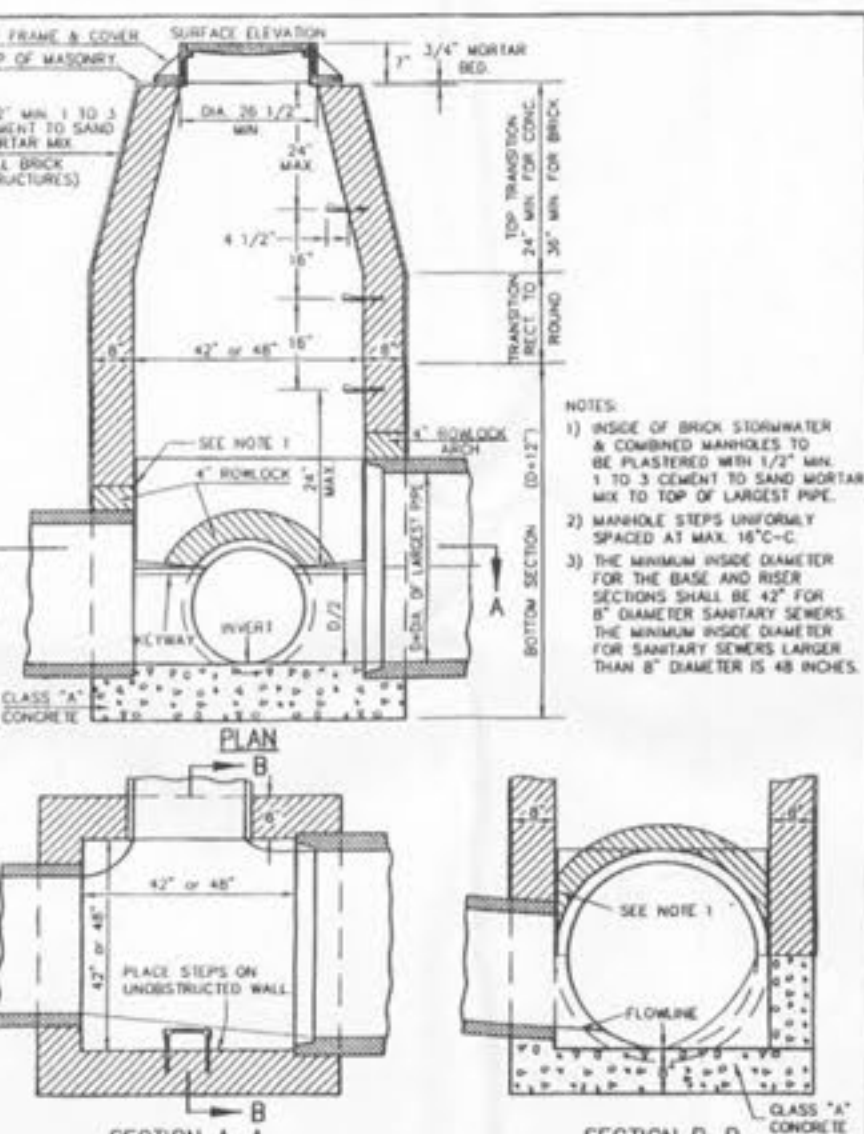

TYPICAL LINE MANHOLE ON PIPE SEWER 27" THRU 42" IN DIAMETER  
METROPOLITAN ST. LOUIS SEWER DISTRICT  
Standard Details of Sewer Construction  
Dr. W.S.H./S.A.M. Ch. J.C.K. 2000 SHEET 11

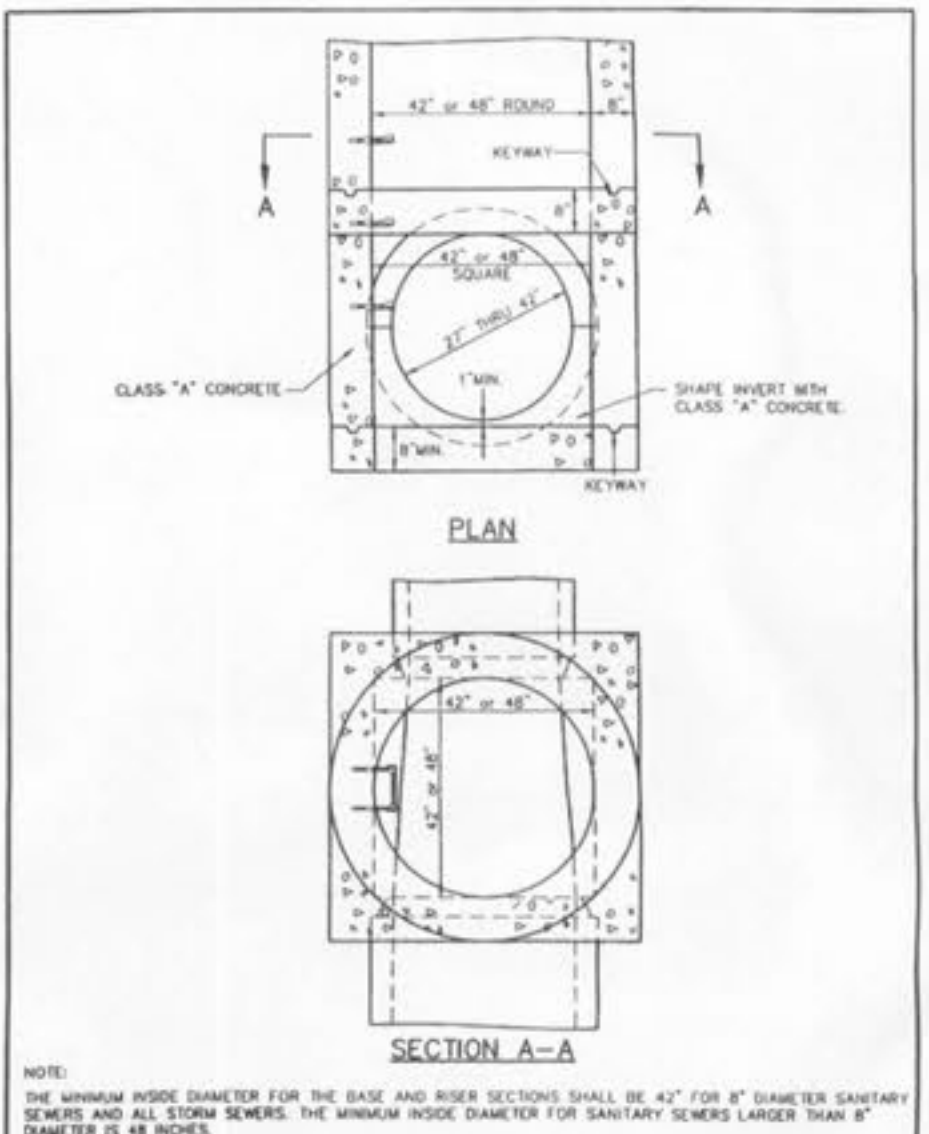

MANHOLE ON PIPE SEWER 27" THRU 42" (ALTERNATE)  
METROPOLITAN ST. LOUIS SEWER DISTRICT  
Standard Details of Sewer Construction  
Dr. D.A.B./S.A.M. Ch. J.C.K. 2000 SHEET 12

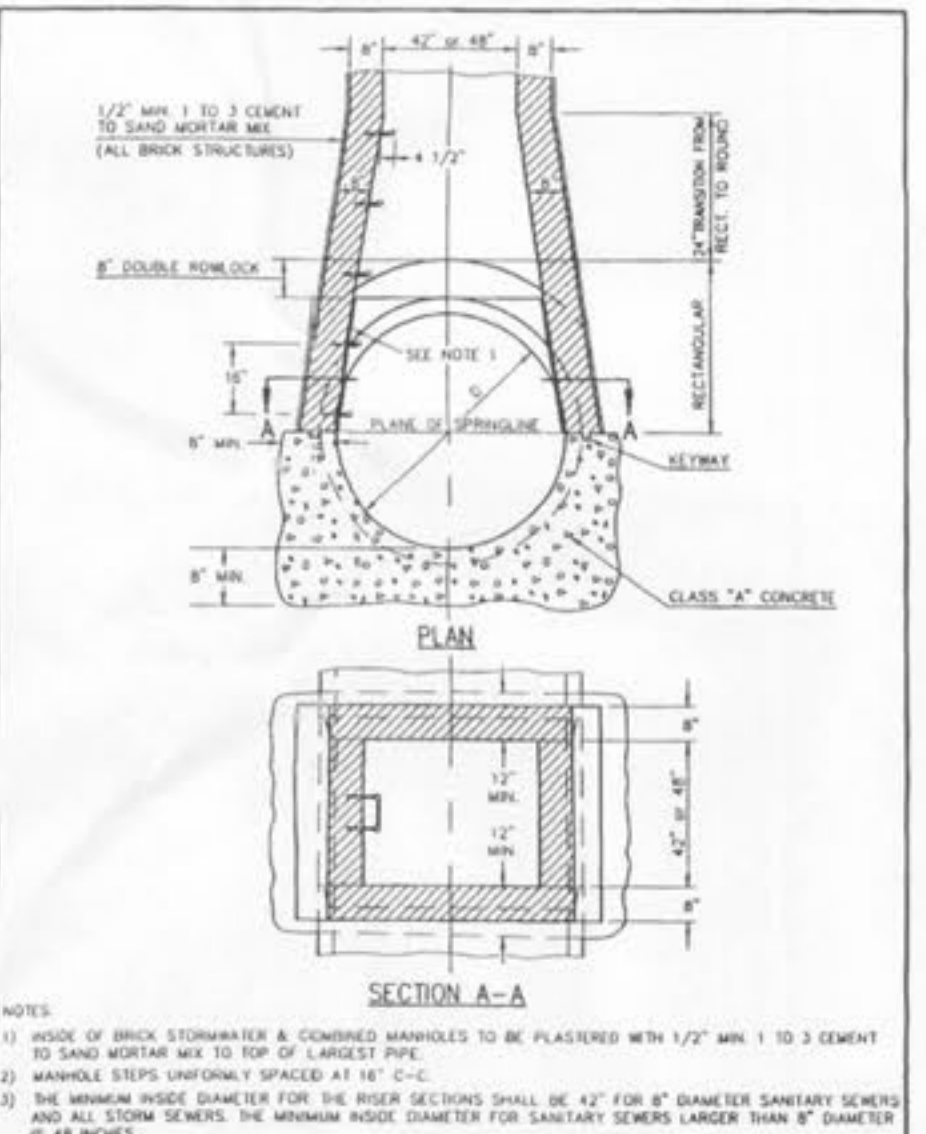

MANHOLE ON CONCRETE PIPE SEWERS 48" THRU 54" DIAMETER  
METROPOLITAN ST. LOUIS SEWER DISTRICT  
Standard Details of Sewer Construction  
Dr. W.S.H./S.A.M. Ch. J.C.K. 2000 SHEET 13

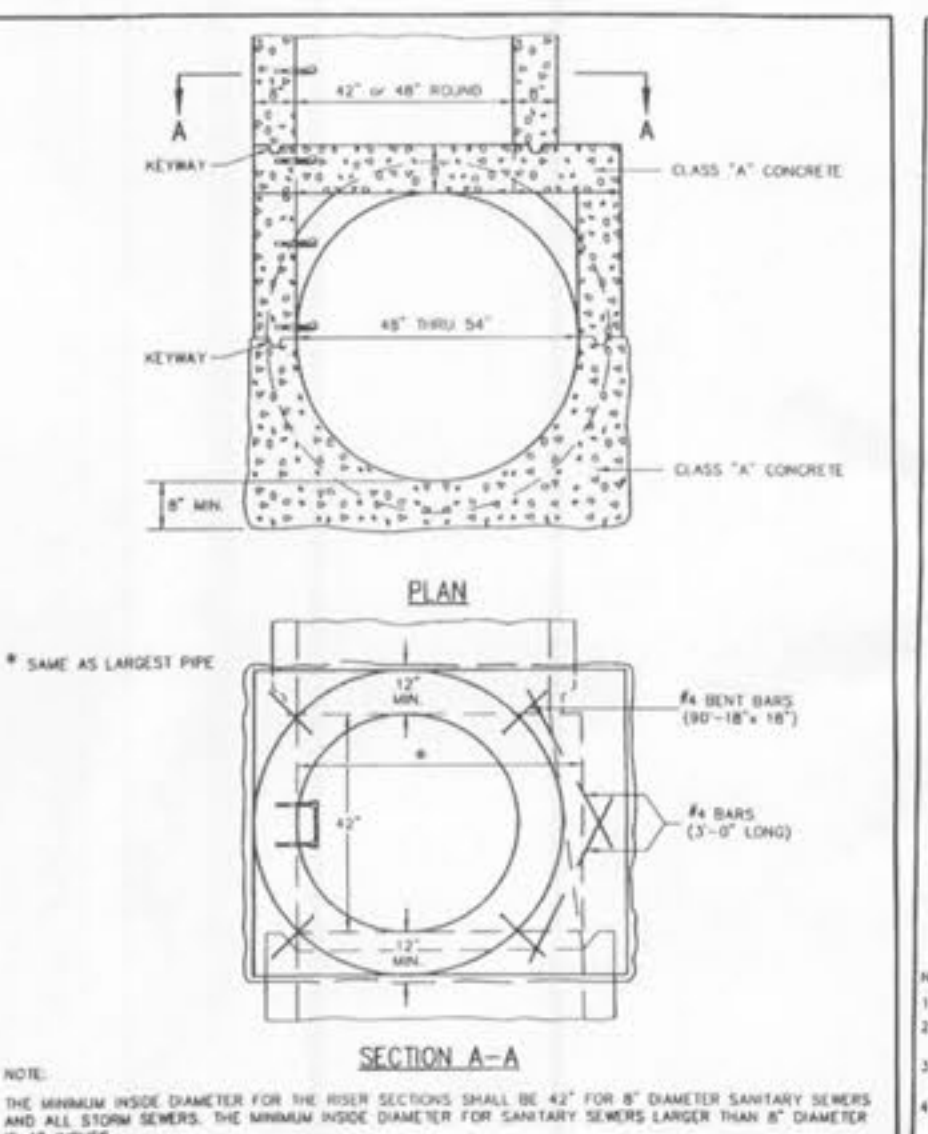

MANHOLE ON CONC. PIPE 48" THRU 54" (ALTERNATE)  
METROPOLITAN ST. LOUIS SEWER DISTRICT  
Standard Details of Sewer Construction  
Dr. W.S.H./S.A.M. Ch. J.C.K. 2000 SHEET 14

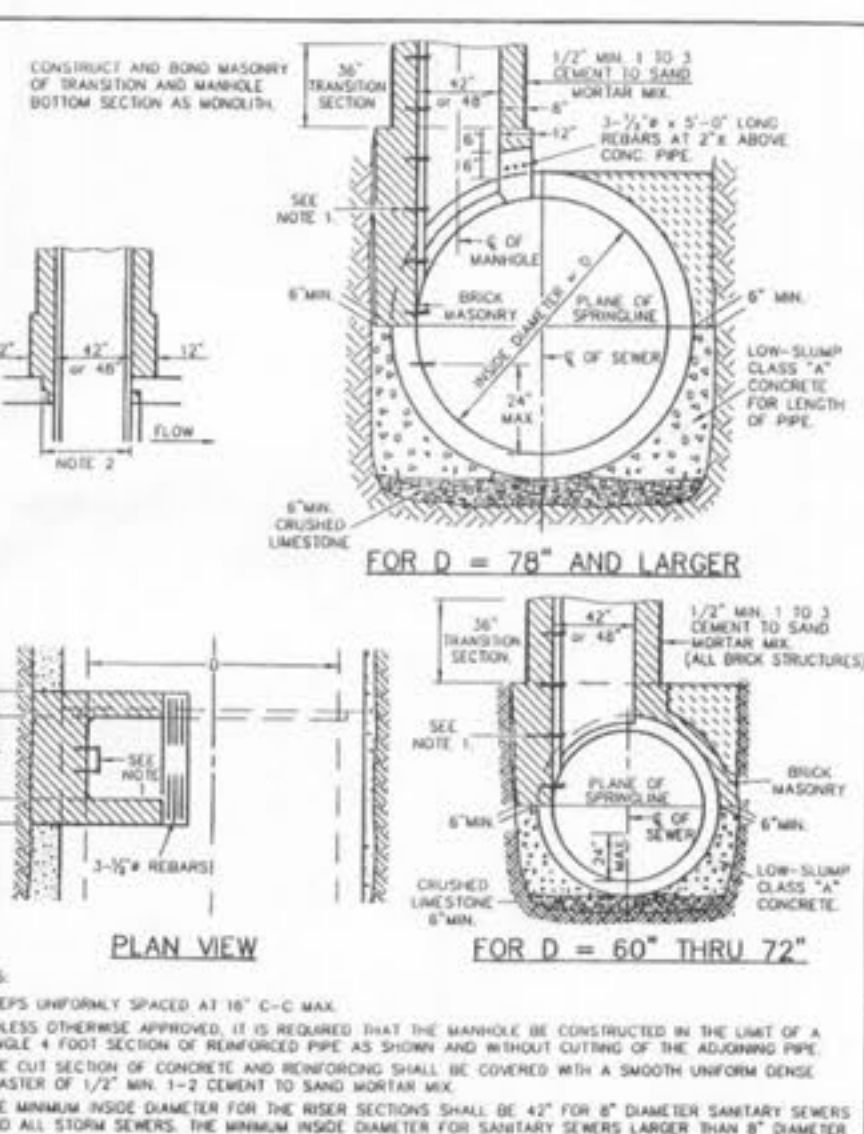

TYPICAL MANHOLE BASE REINFORCED CONCRETE PIPE SEWERS 60" AND LARGER IN DIAMETER  
METROPOLITAN ST. LOUIS SEWER DISTRICT  
Standard Details of Sewer Construction  
Dr. W.S.H./S.A.M. Ch. J.C.K. 2000 SHEET 15

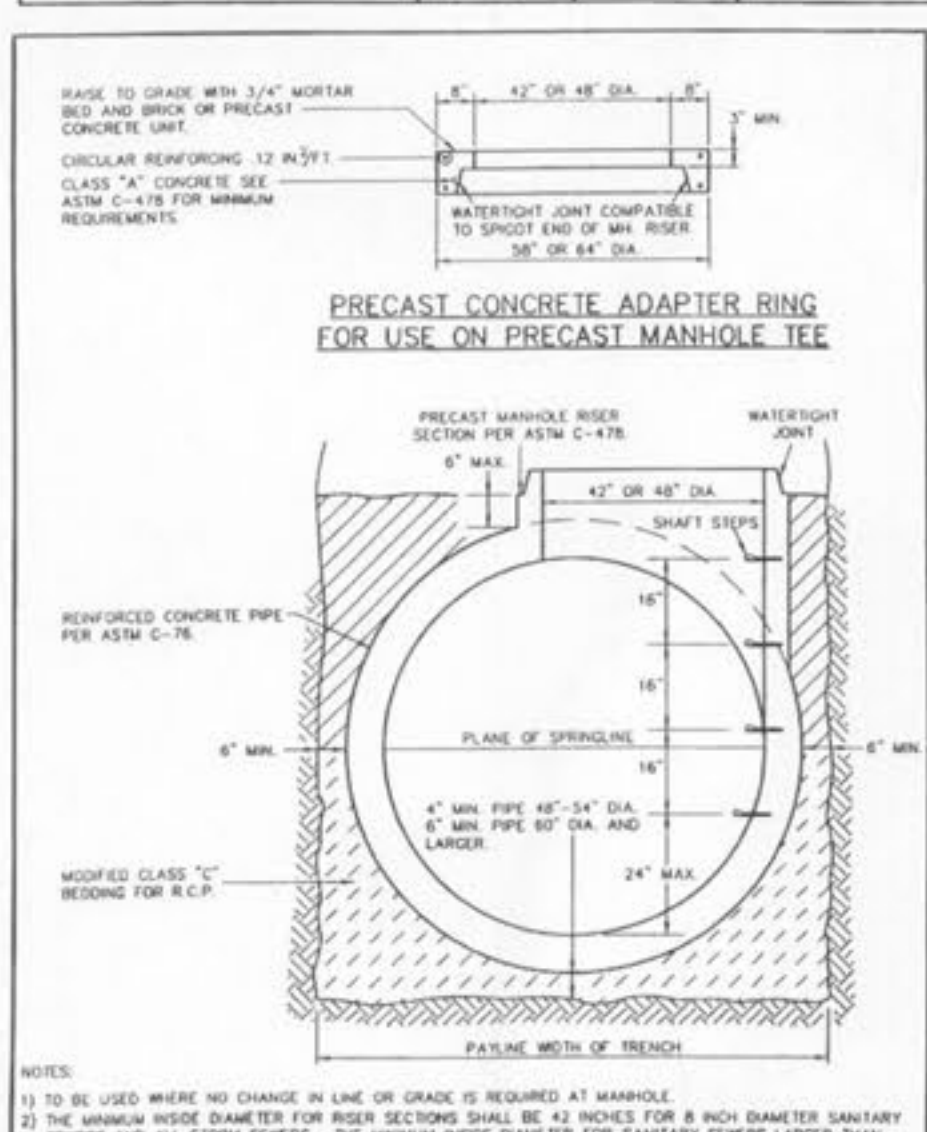

TYPICAL PRECAST MANHOLE TEE FOR REINFORCED CONCRETE PIPE SEWERS 48 INCH AND LARGER IN DIAMETER  
METROPOLITAN ST. LOUIS SEWER DISTRICT  
Standard Details of Sewer Construction  
Dr. W.S.H./S.A.M. Ch. J.C.K. 2000 SHEET 24

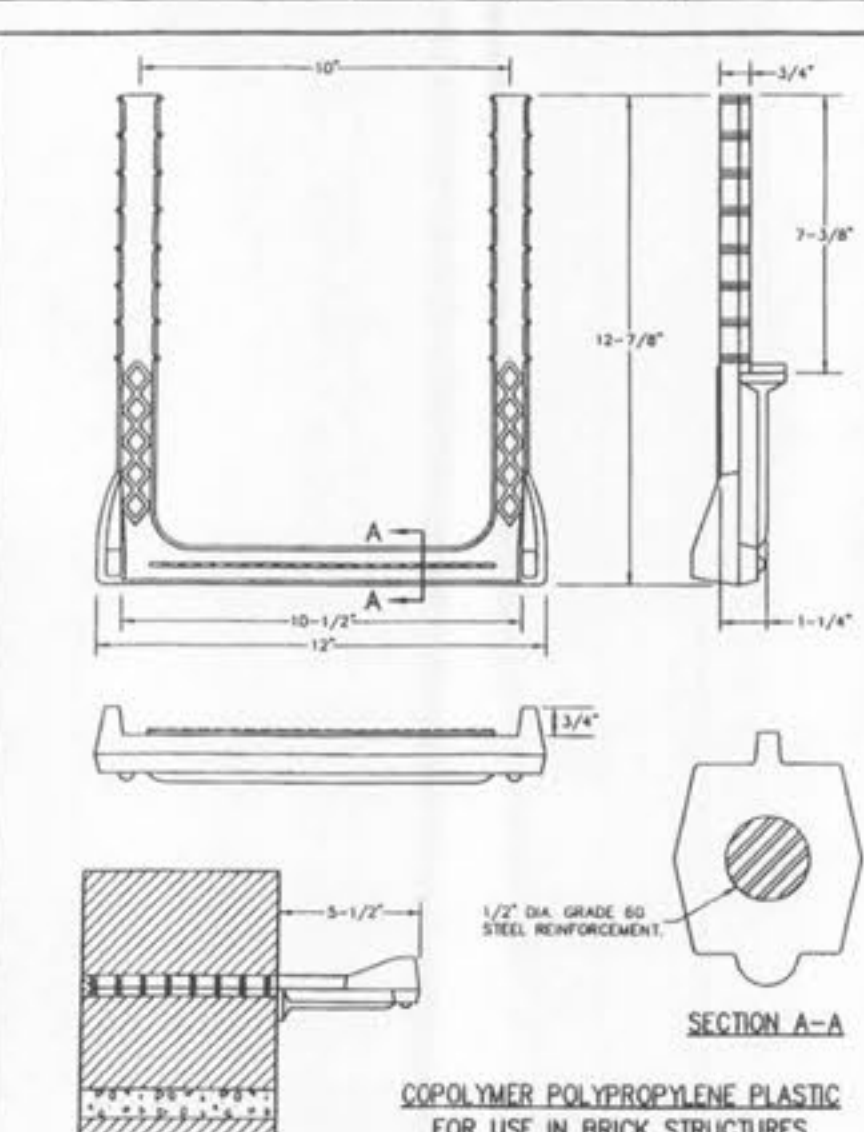

PS1-B MANHOLE STEP INTO JOINT  
METROPOLITAN ST. LOUIS SEWER DISTRICT  
Standard Details of Sewer Construction  
Dr. W.S.H. Ch. J.C.K. 2000 SHEET 57

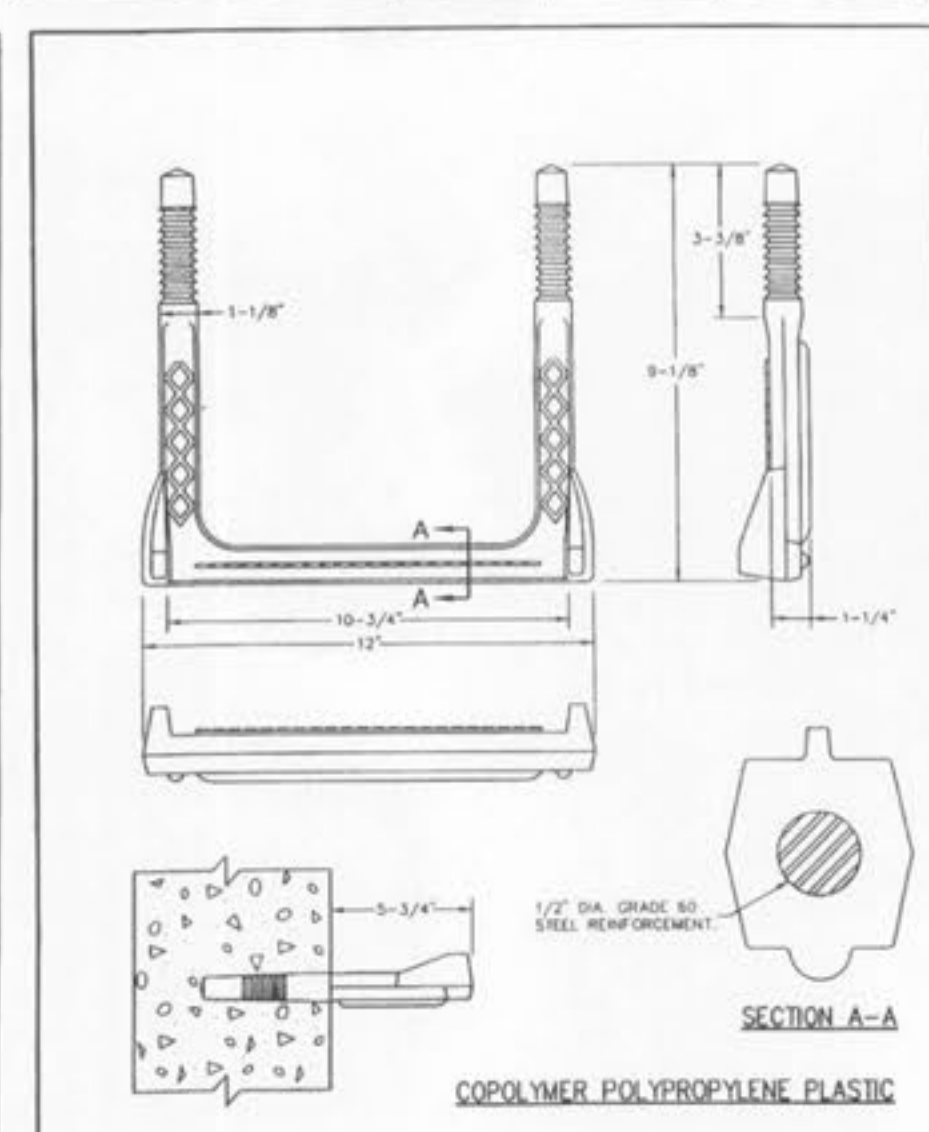

MANHOLE STEP FOR PRECAST & CAST-IN-PLACE MANHOLE  
METROPOLITAN ST. LOUIS SEWER DISTRICT  
Standard Details of Sewer Construction  
Dr. D.A.B. Ch. J.C.K. 2000 SHEET 58