

LOCKING DEVICE FOR TYPE "T" LOCK TYPE MANHOLE COVER
 METROPOLITAN ST. LOUIS SEWER DISTRICT
 Standard Details of Sewer Construction
 D: RCH/TEAM Ch. J.C.K. 2000 SHEET 55

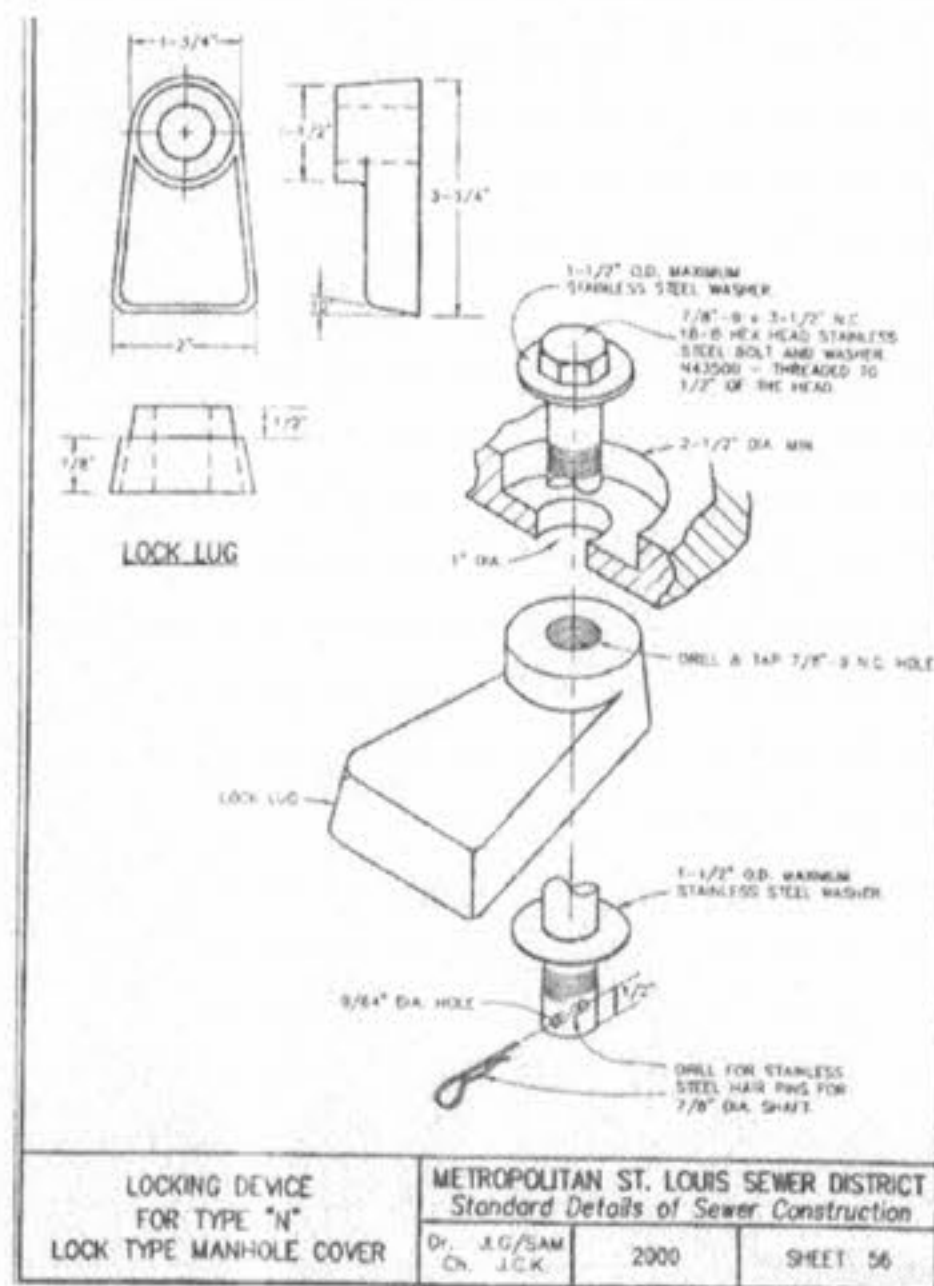

LOCKING DEVICE FOR TYPE "N" LOCK TYPE MANHOLE COVER
 METROPOLITAN ST. LOUIS SEWER DISTRICT
 Standard Details of Sewer Construction
 D: J.G./TEAM Ch. J.C.K. 2000 SHEET 56

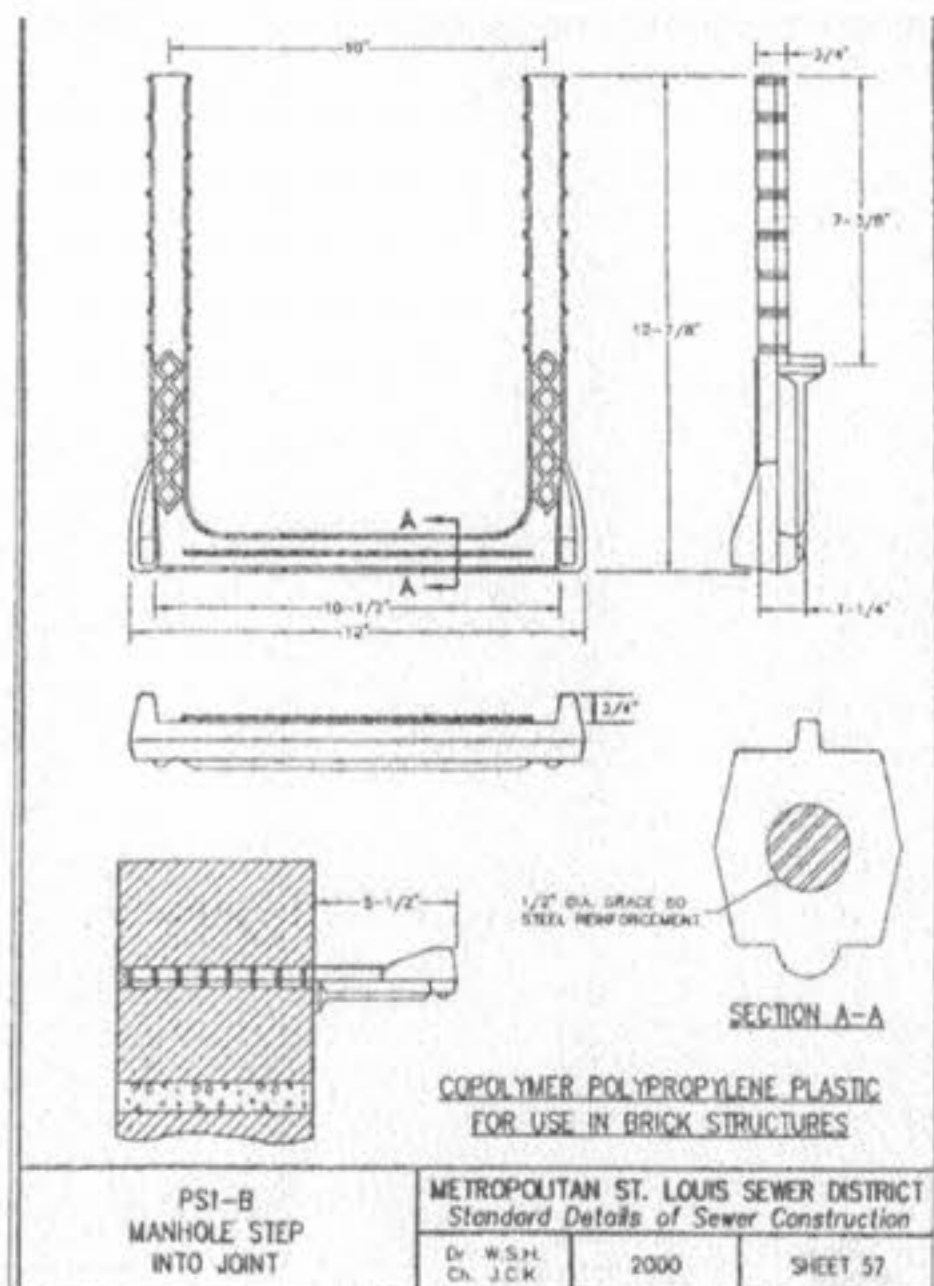

PSI-B MANHOLE STEP INTO JOINT
 METROPOLITAN ST. LOUIS SEWER DISTRICT
 Standard Details of Sewer Construction
 D: W.S.H. Ch. J.C.K. 2000 SHEET 57

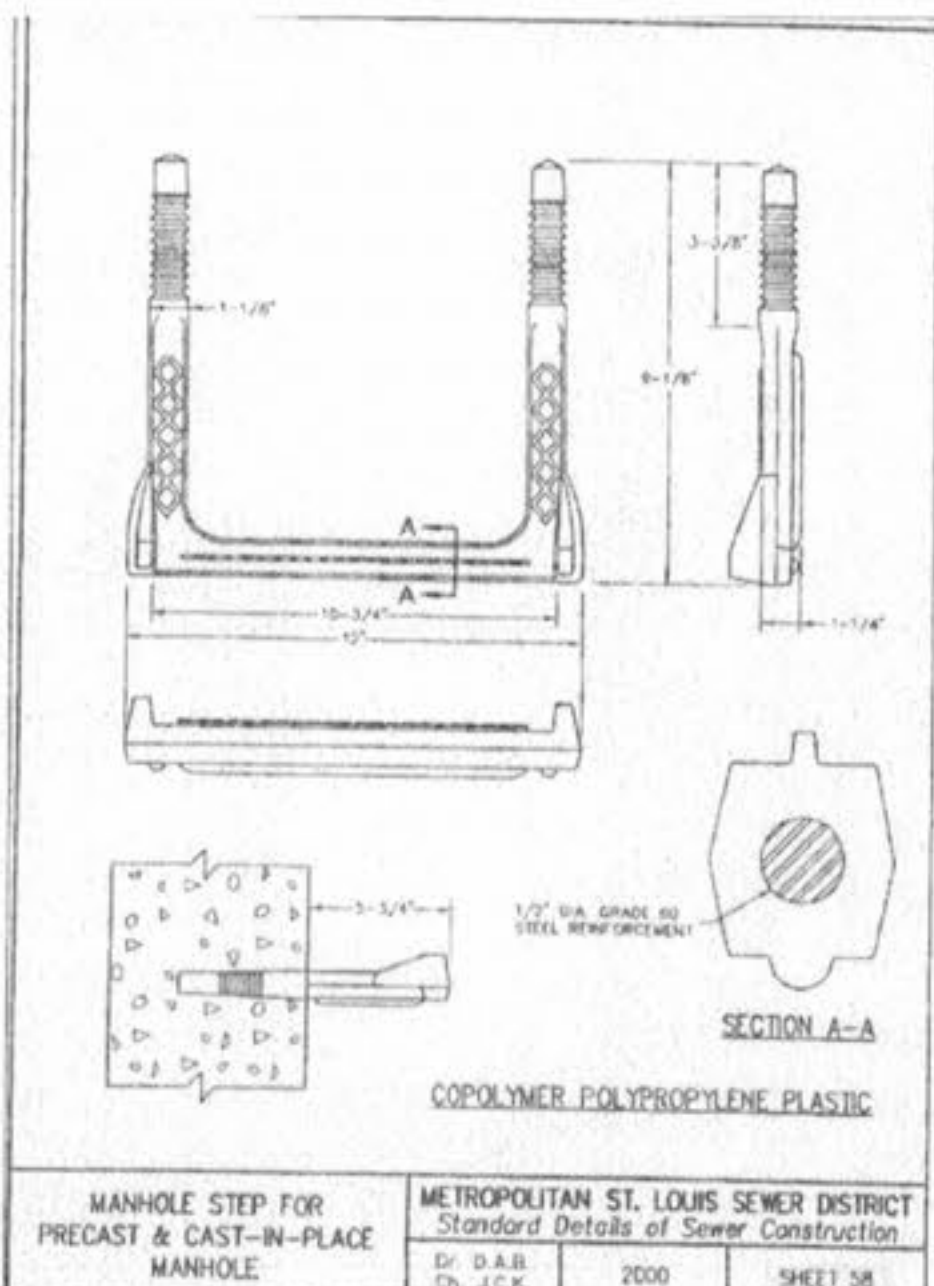

MANHOLE STEP FOR PRECAST & CAST-IN-PLACE MANHOLE
 METROPOLITAN ST. LOUIS SEWER DISTRICT
 Standard Details of Sewer Construction
 D: D.A.B. Ch. J.C.K. 2000 SHEET 58

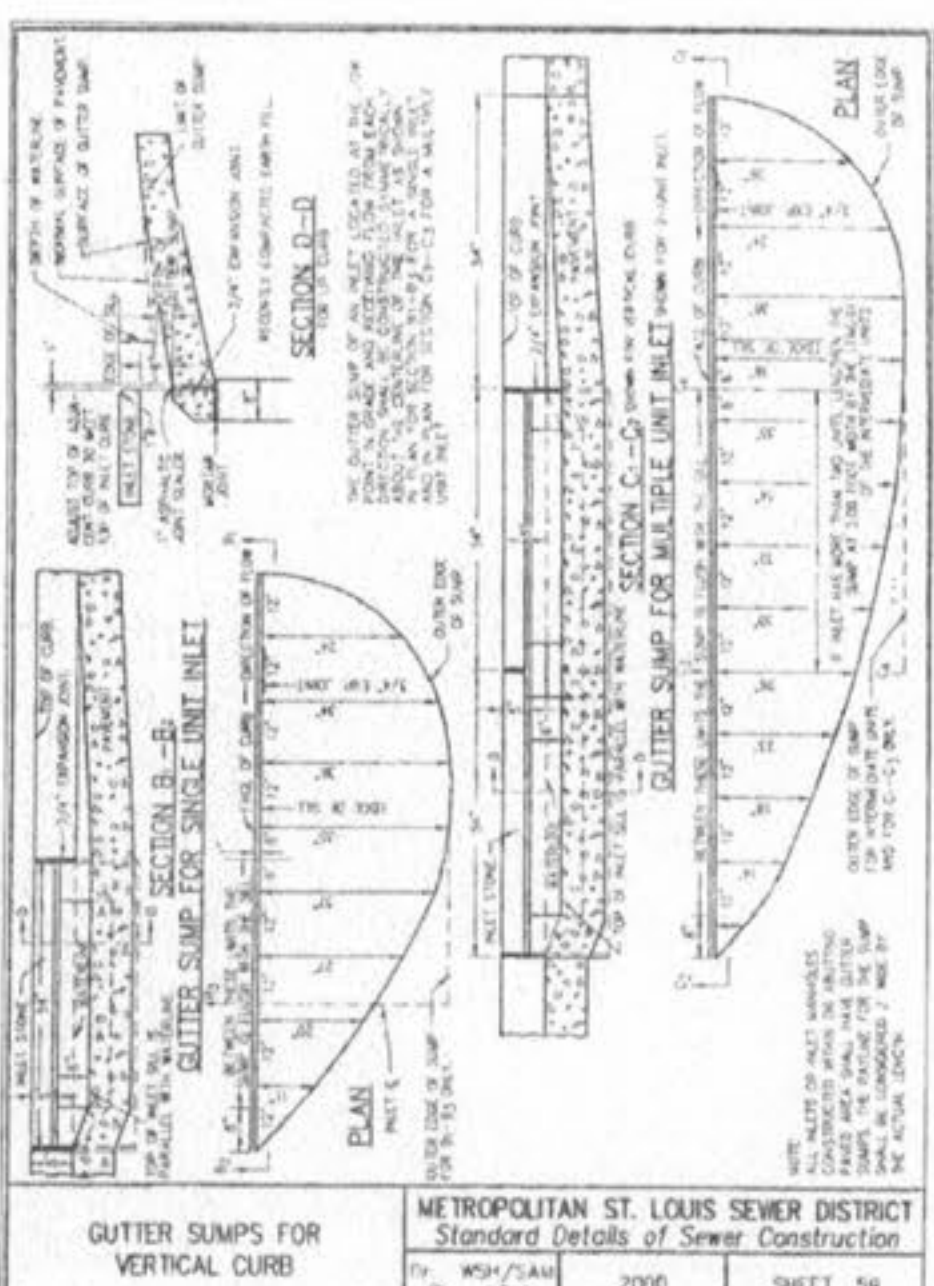

GUTTER SUMPS FOR VERTICAL CURB
 METROPOLITAN ST. LOUIS SEWER DISTRICT
 Standard Details of Sewer Construction
 D: W.H./TEAM Ch. J.C.K. 2000 SHEET 59

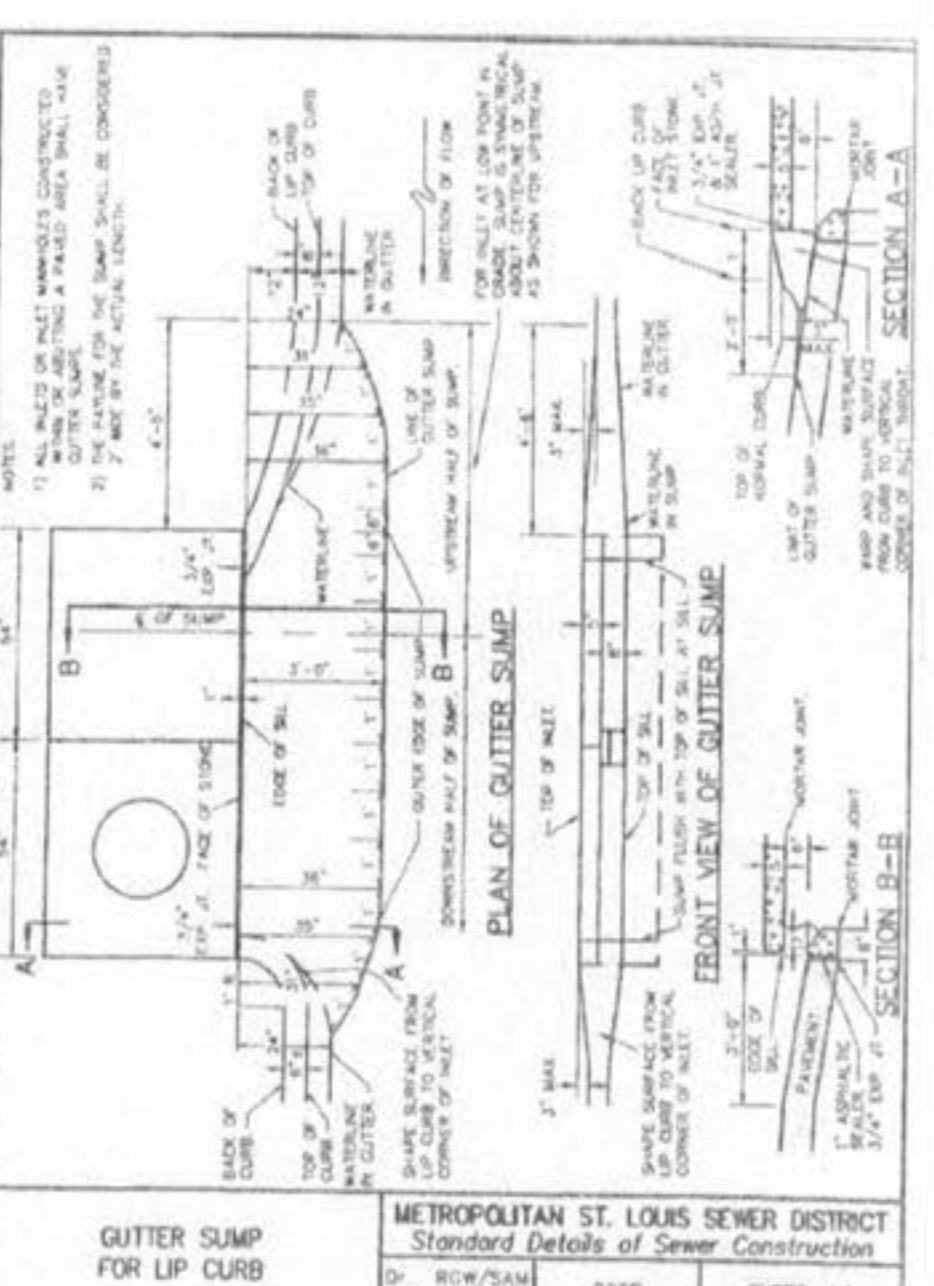

GUTTER SUMP FOR LIP CURB
 METROPOLITAN ST. LOUIS SEWER DISTRICT
 Standard Details of Sewer Construction
 D: RCH/TEAM Ch. J.C.K. 2000 SHEET 60

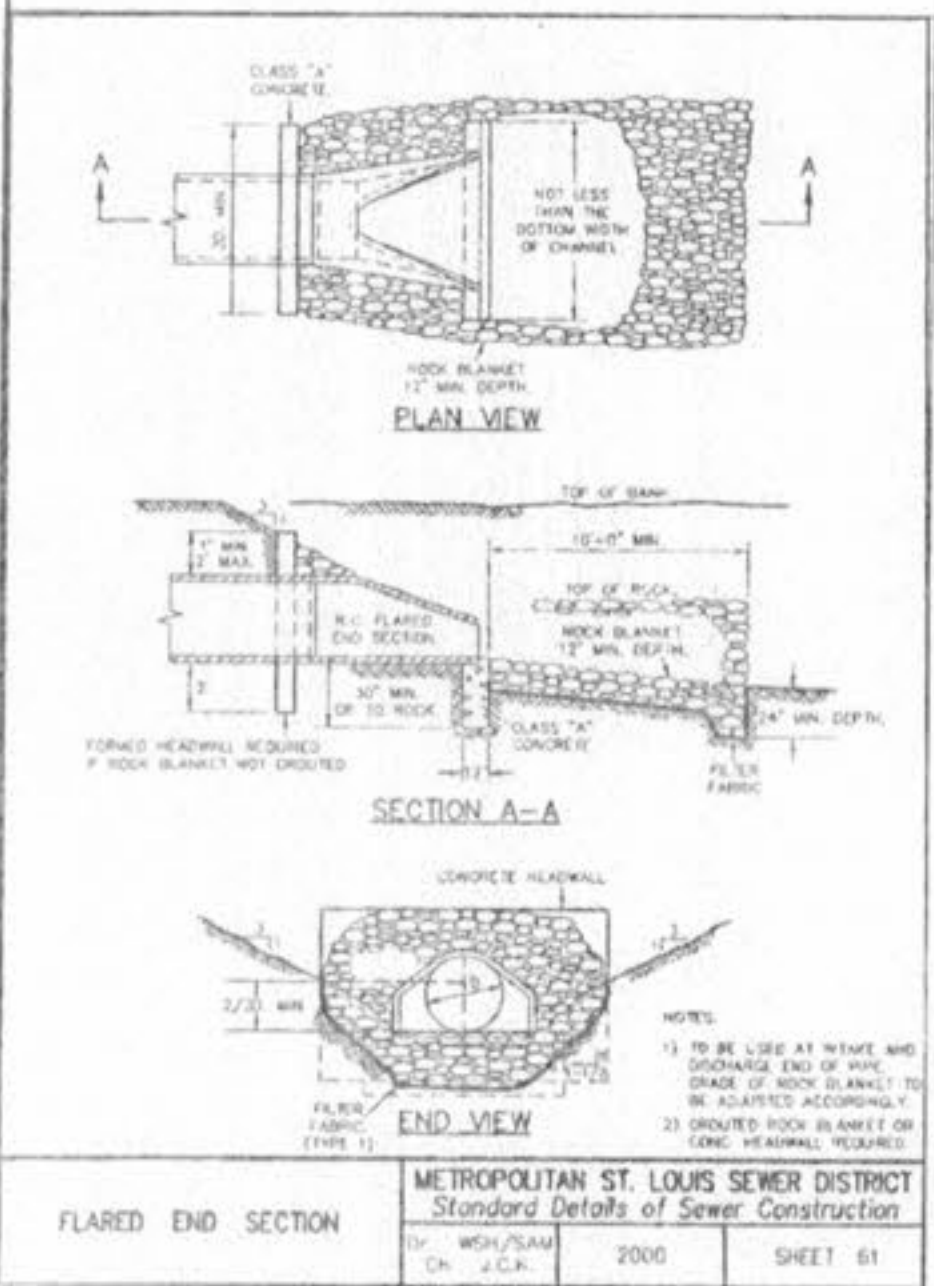

FLARED END SECTION
 METROPOLITAN ST. LOUIS SEWER DISTRICT
 Standard Details of Sewer Construction
 D: W.H./TEAM Ch. J.C.K. 2000 SHEET 61

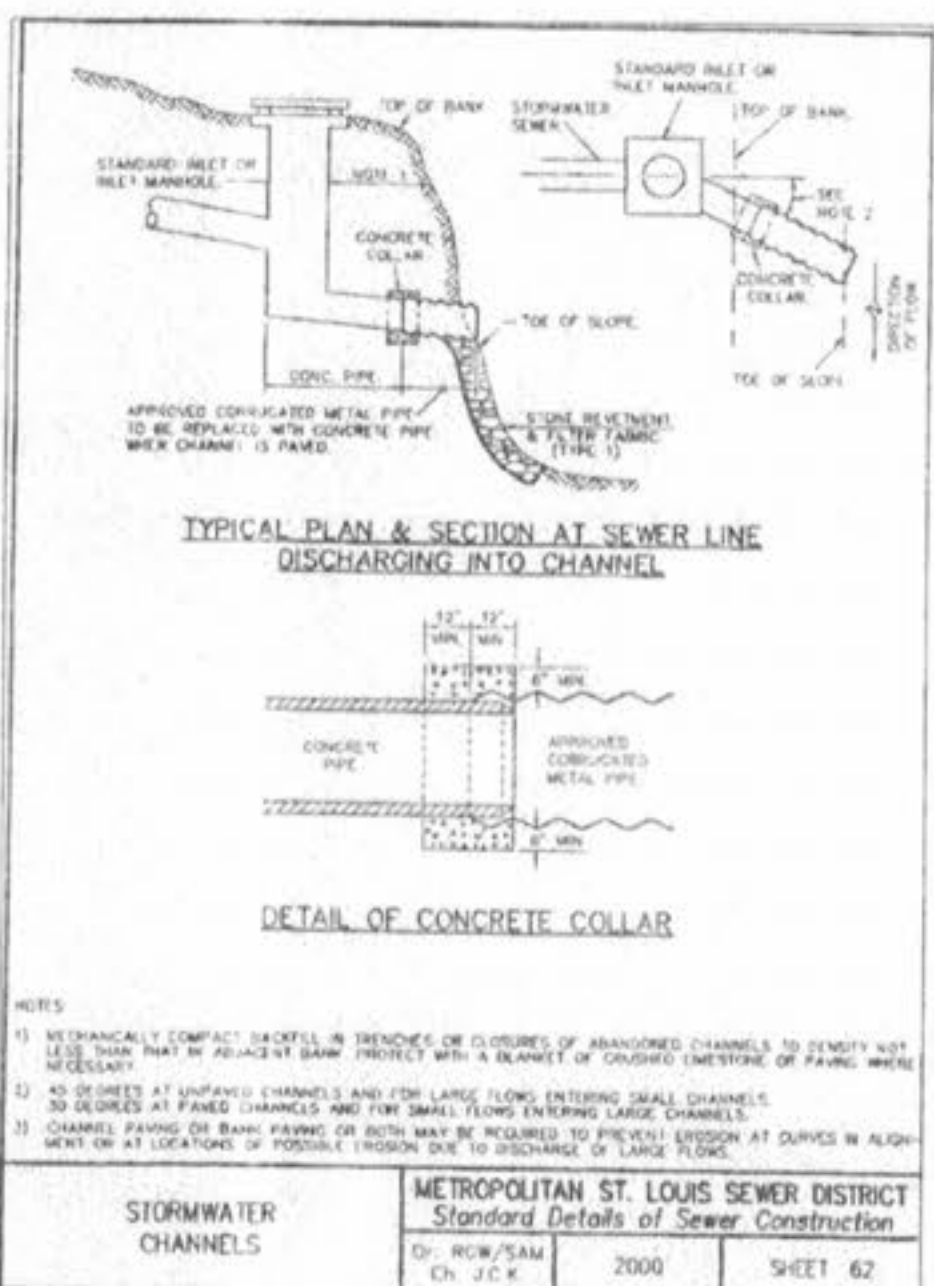

STORMWATER CHANNELS
 METROPOLITAN ST. LOUIS SEWER DISTRICT
 Standard Details of Sewer Construction
 D: RCH/TEAM Ch. J.C.K. 2000 SHEET 62

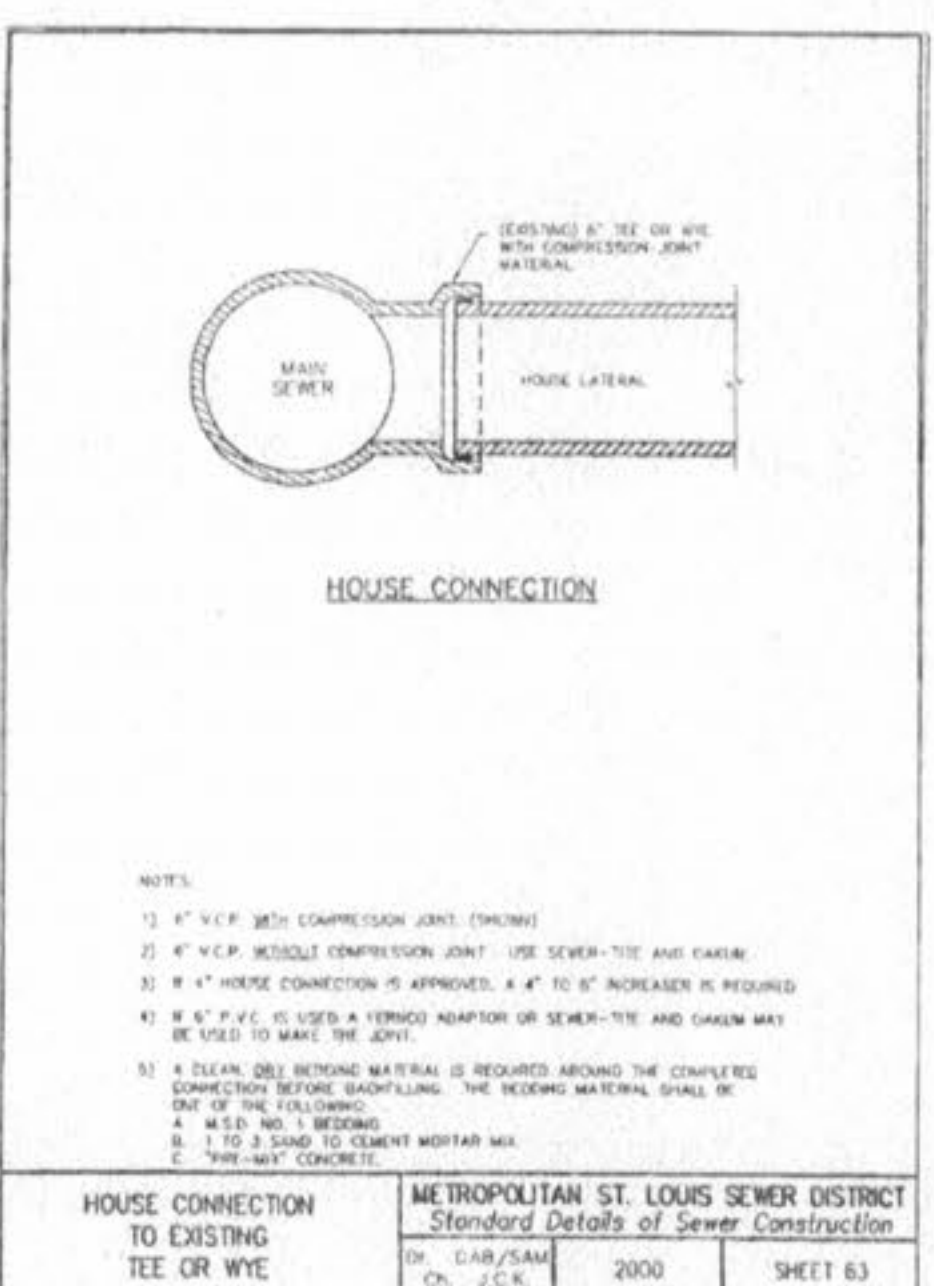

HOUSE CONNECTION TO EXISTING TEE OR WYE
 METROPOLITAN ST. LOUIS SEWER DISTRICT
 Standard Details of Sewer Construction
 D: L.H.R./TEAM Ch. J.C.K. 2000 SHEET 63

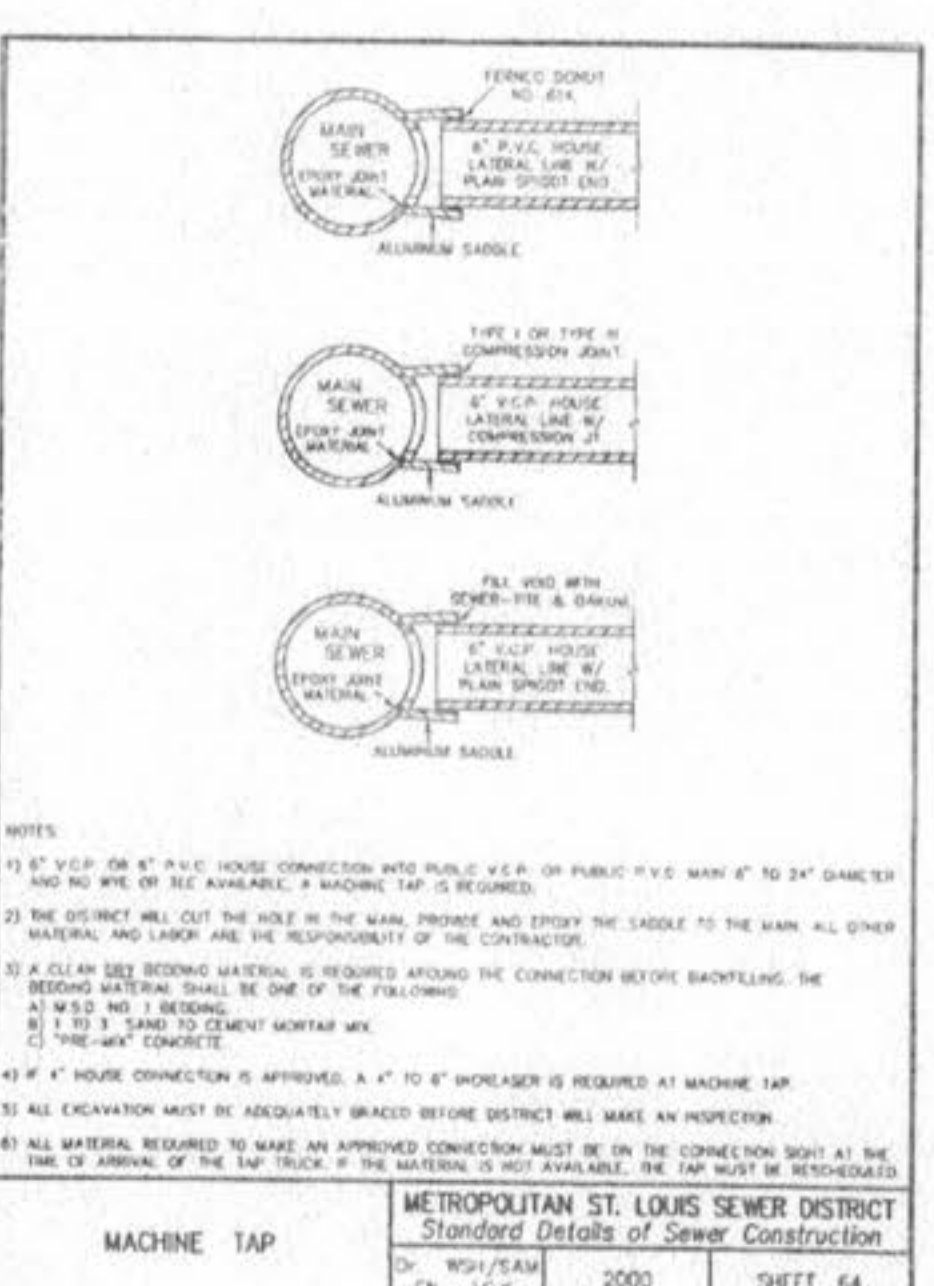

MACHINE TAP
 METROPOLITAN ST. LOUIS SEWER DISTRICT
 Standard Details of Sewer Construction
 D: W.H./TEAM Ch. J.C.K. 2000 SHEET 64

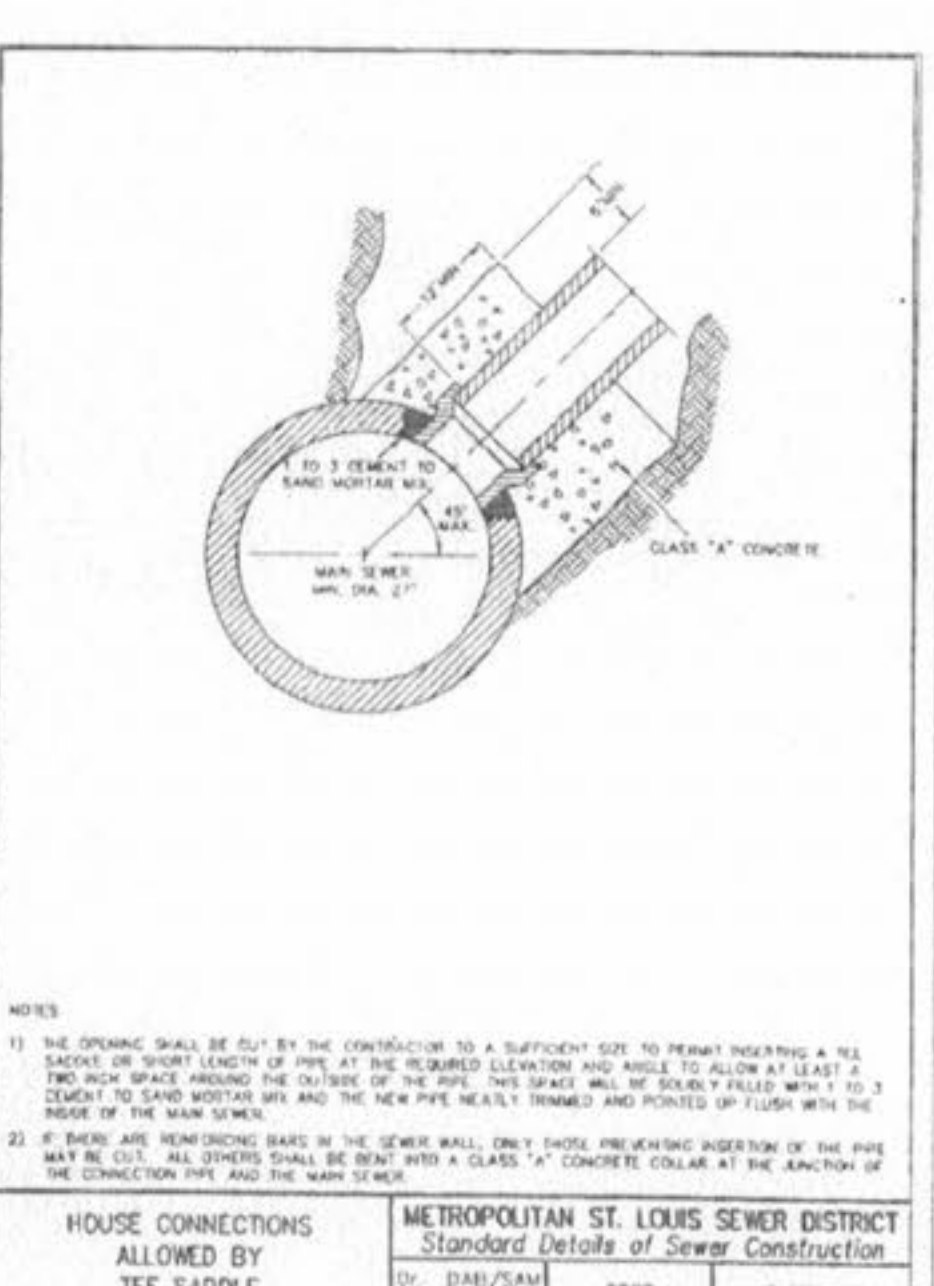

HOUSE CONNECTIONS ALLOWED BY TEE SADDLE
 METROPOLITAN ST. LOUIS SEWER DISTRICT
 Standard Details of Sewer Construction
 D: D.A.B./TEAM Ch. J.C.K. 2000 SHEET 65

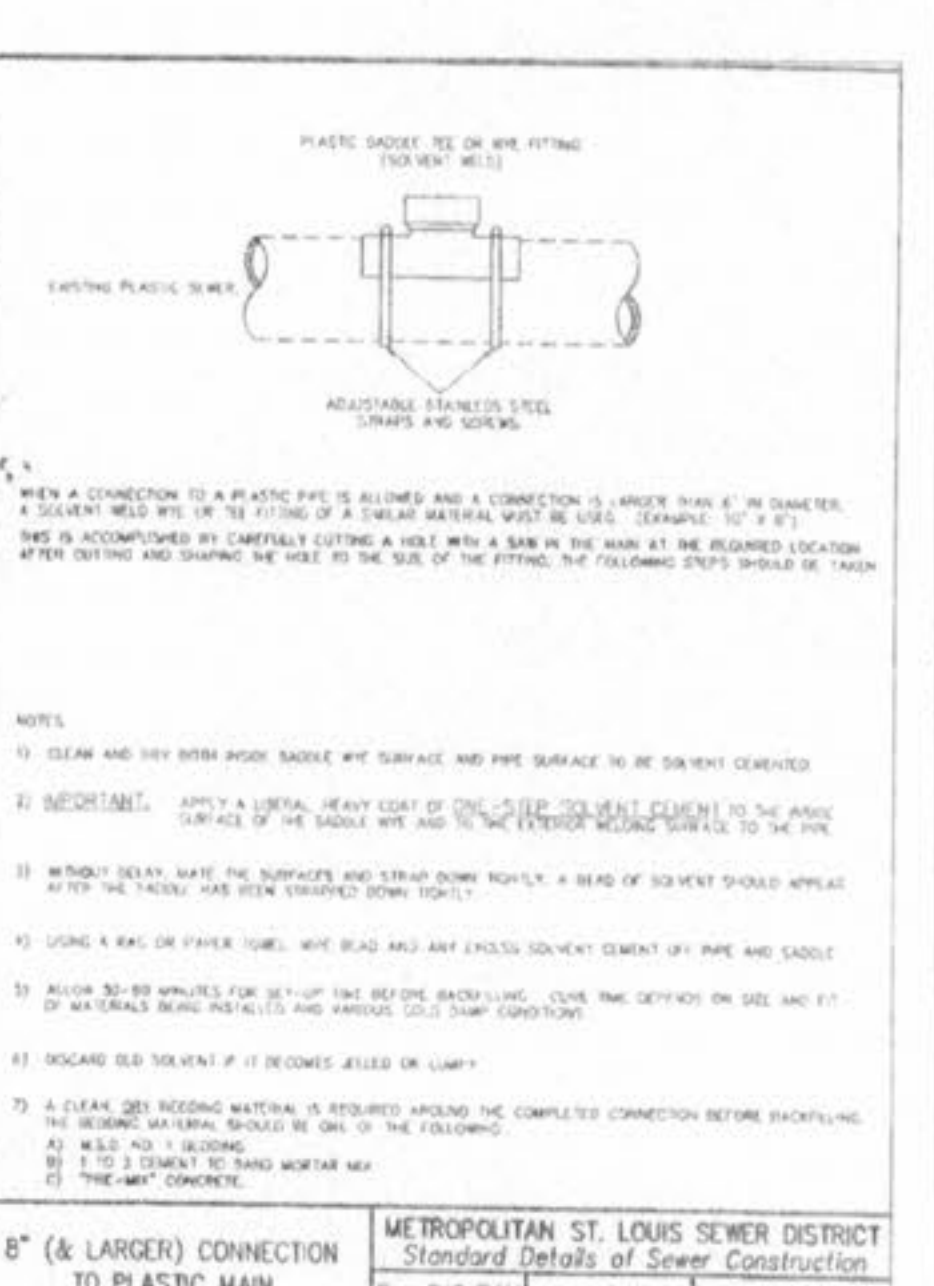

**8\"/>
 METROPOLITAN ST. LOUIS SEWER DISTRICT
 Standard Details of Sewer Construction
 D: D.A.B./TEAM Ch. J.C.K. 2000 SHEET 66**

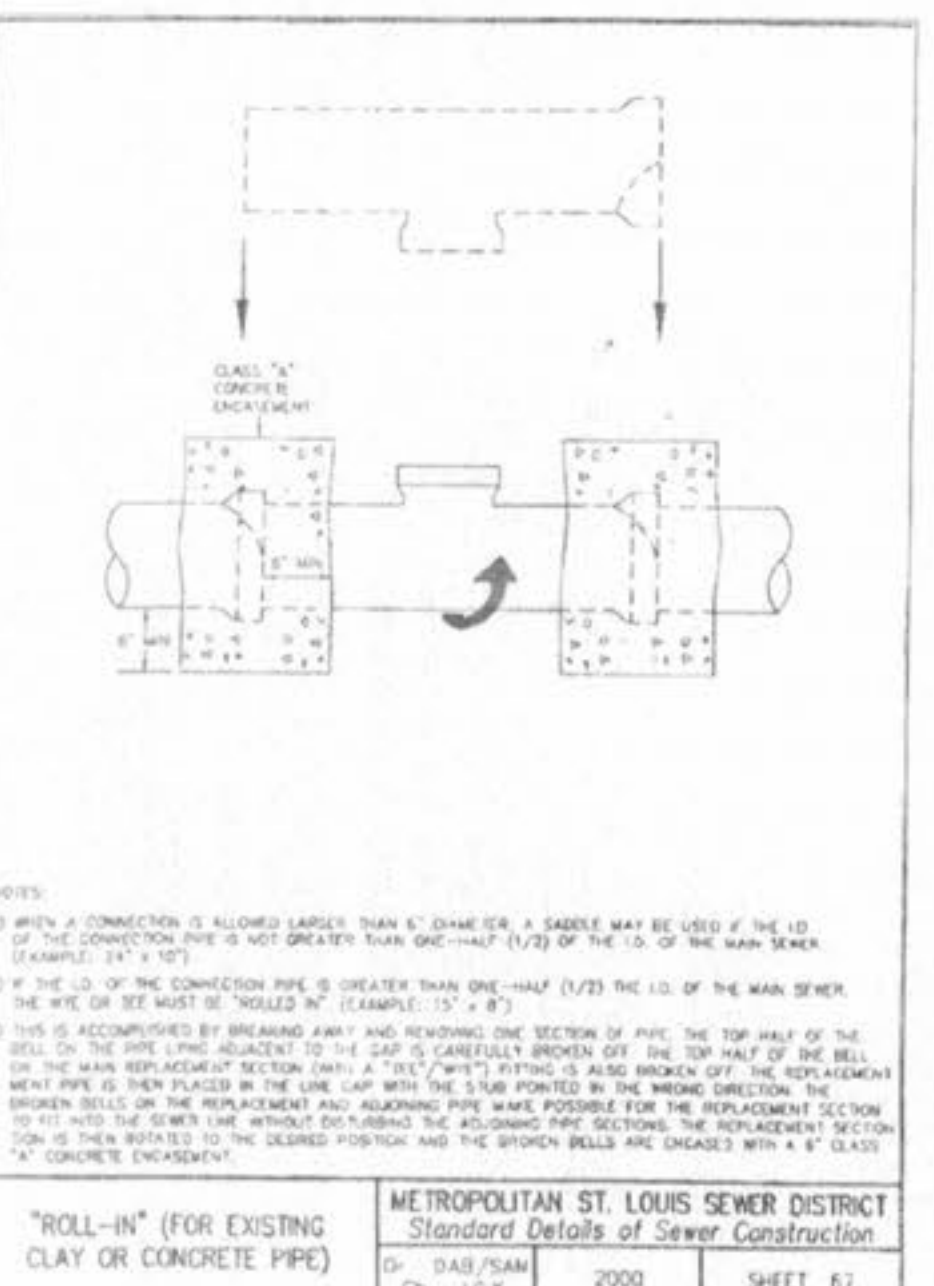

"ROLL-IN" FOR EXISTING CLAY OR CONCRETE PIPE
 METROPOLITAN ST. LOUIS SEWER DISTRICT
 Standard Details of Sewer Construction
 D: D.A.B./TEAM Ch. J.C.K. 2000 SHEET 67

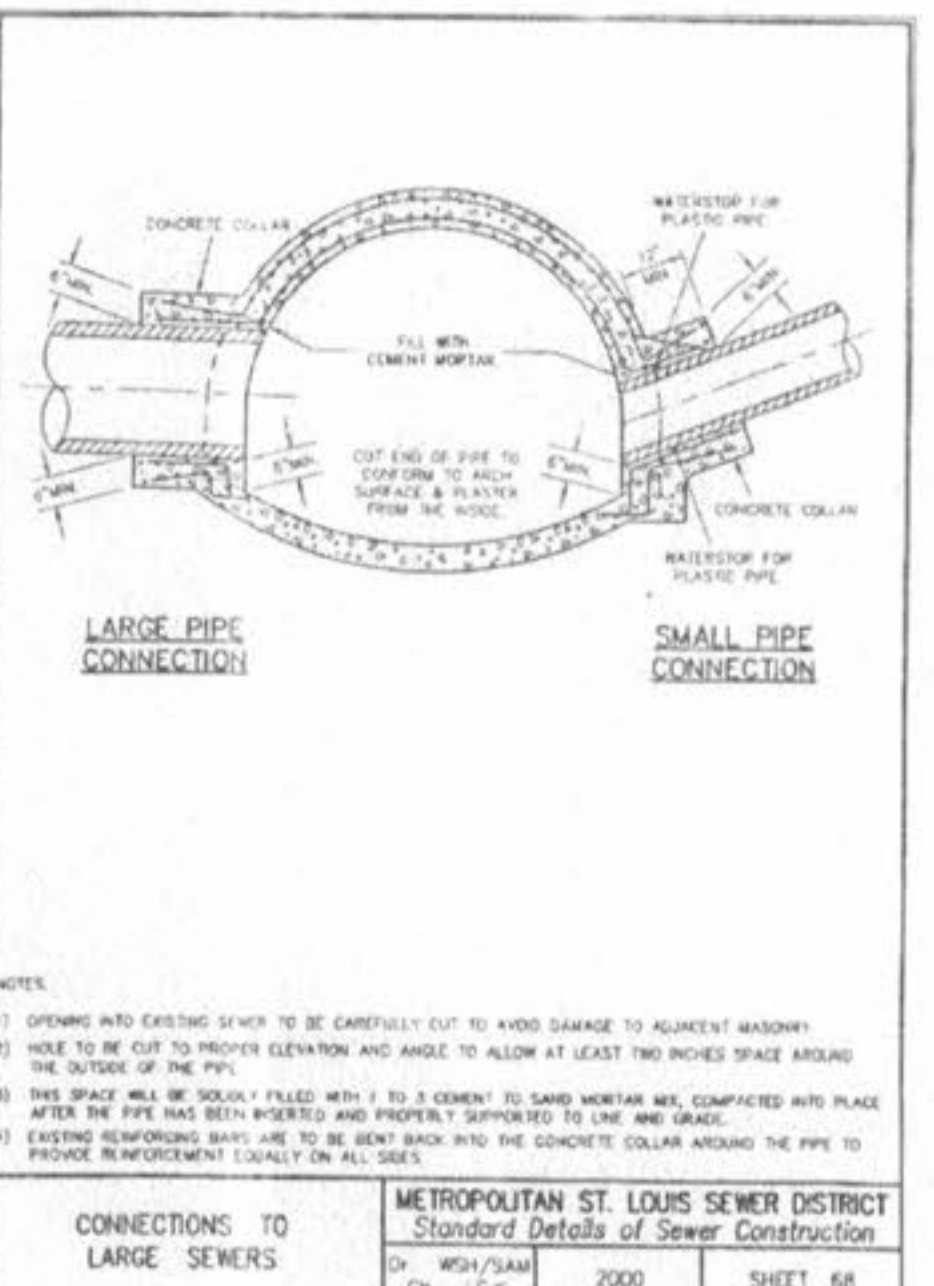

CONNECTIONS TO LARGE SEWERS
 METROPOLITAN ST. LOUIS SEWER DISTRICT
 Standard Details of Sewer Construction
 D: W.H./TEAM Ch. J.C.K. 2000 SHEET 68

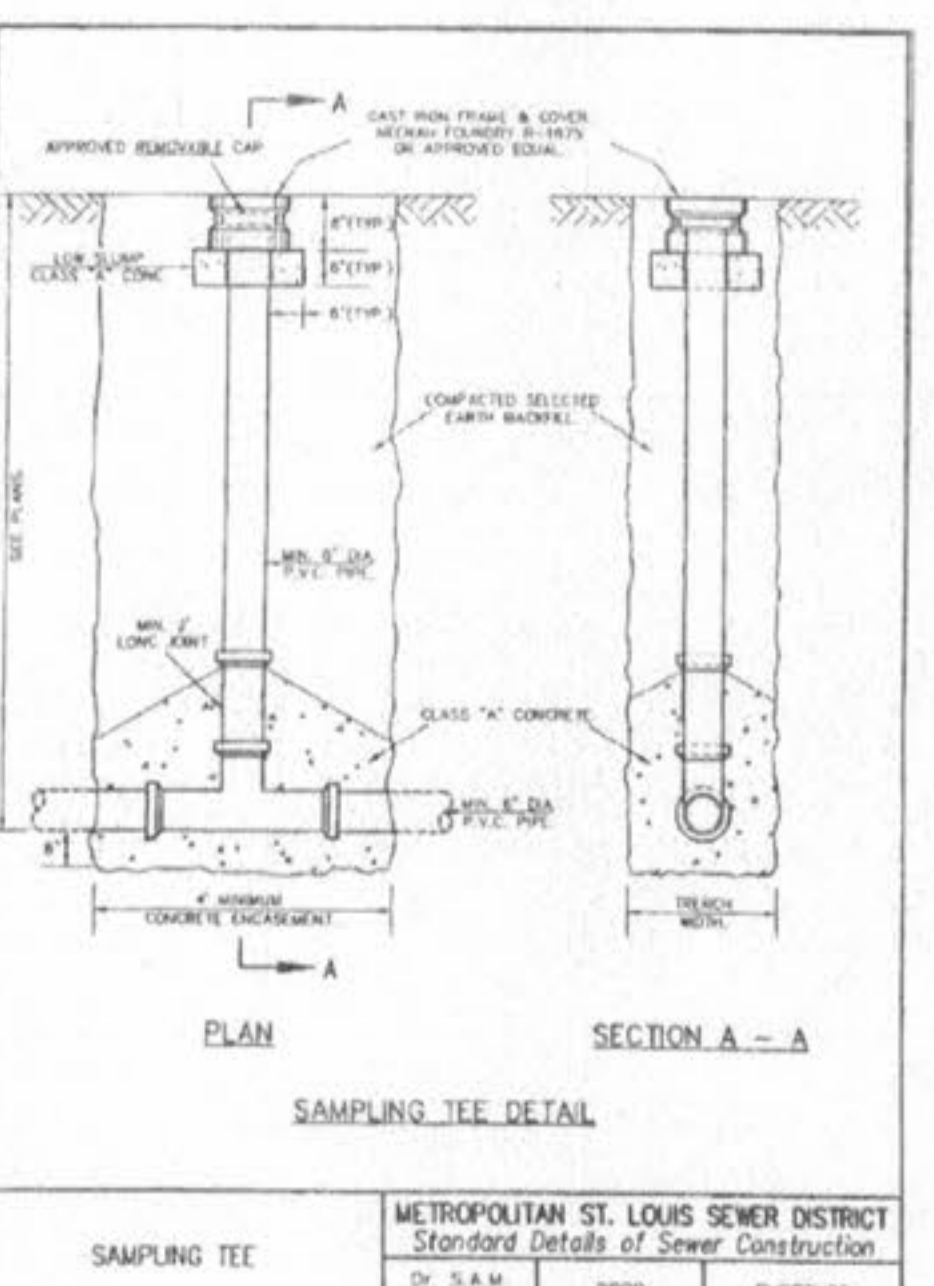

SAMPLING TEE
 METROPOLITAN ST. LOUIS SEWER DISTRICT
 Standard Details of Sewer Construction
 D: S.A.M. Ch. J.C.K. 2000 SHEET 69

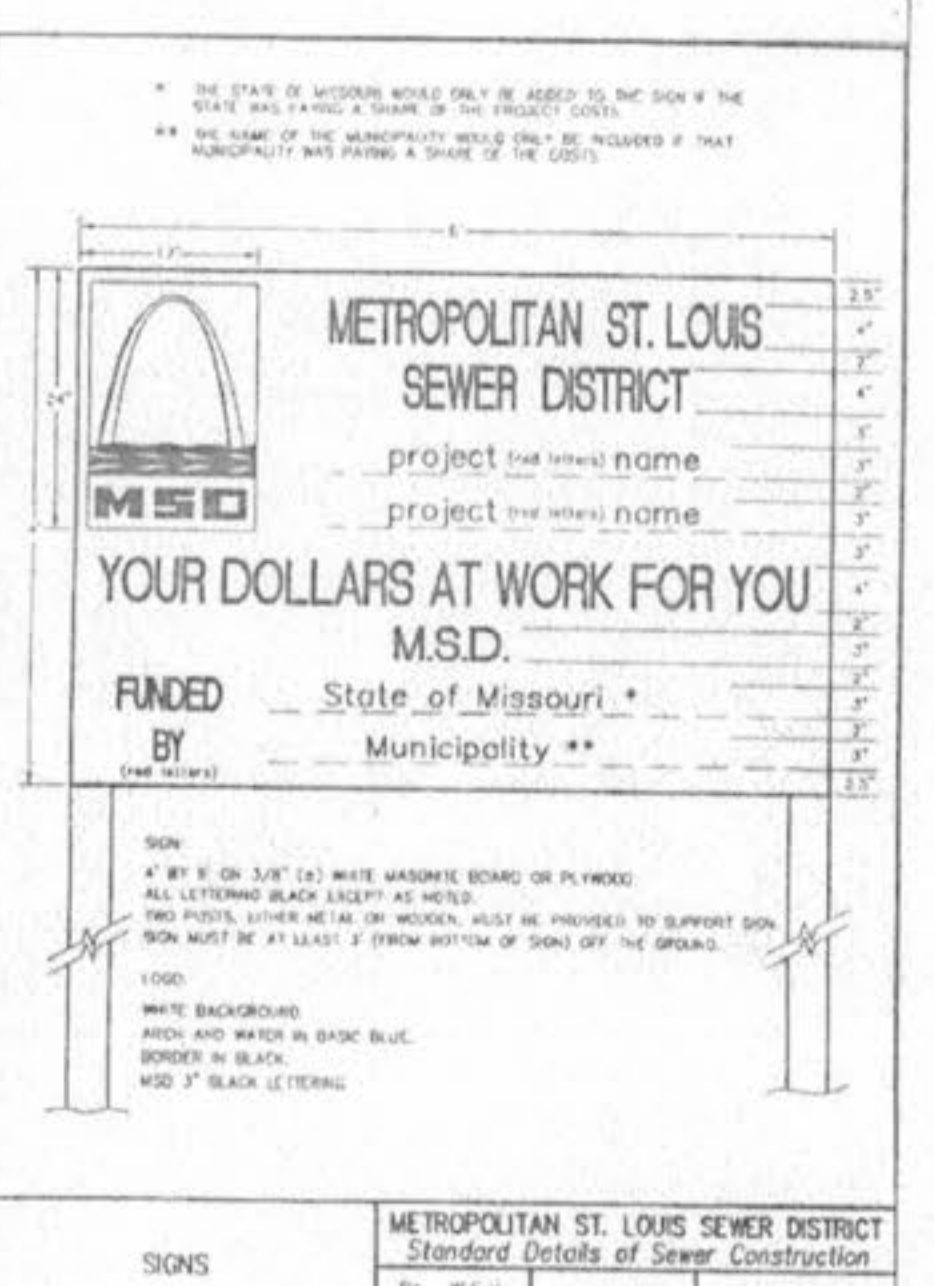

SIGNS
 METROPOLITAN ST. LOUIS SEWER DISTRICT
 Standard Details of Sewer Construction
 D: W.S.H. Ch. J.C.K. 2000 SHEET 70

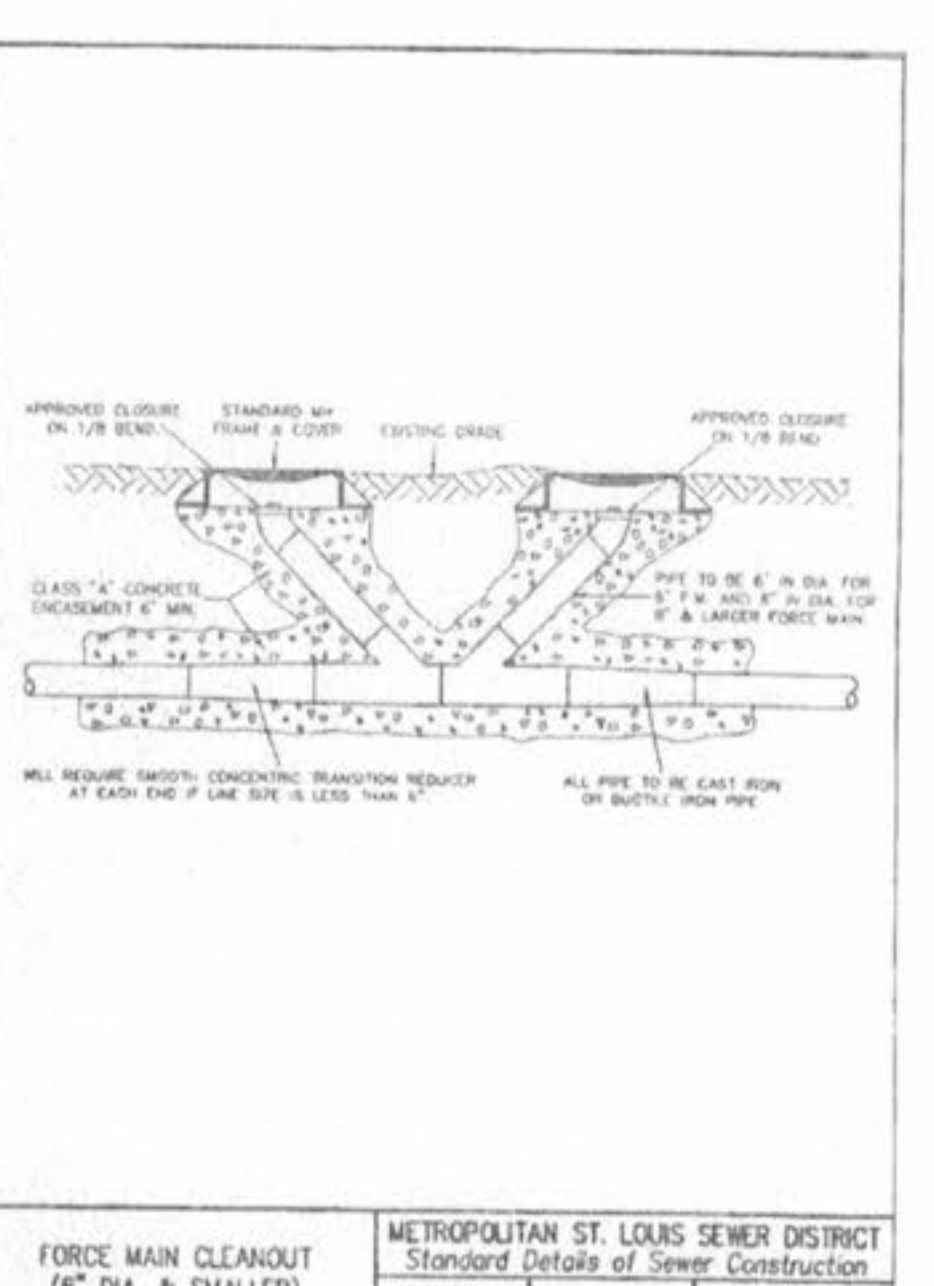

**FORCE MAIN CLEANOUT (6\"/>
 METROPOLITAN ST. LOUIS SEWER DISTRICT
 Standard Details of Sewer Construction
 D: RCH/TEAM Ch. J.C.K. 2000 SHEET 71**

ISSUE	REMARKS/DATE
1	05-14-03 1st Submittal
2	05-24-03 City of Of/lor Comments

PREPARED FOR:
McBride & Son Home, Inc.
 #1 McBride & Son Center Drive
 Chesterfield, Missouri 63005
 (636) 537-2000

PREPARED BY:
THE STERLING CO.
 ENGINEERS & SURVEYORS
 5965 NEW BAUMGARTNER ROAD
 ST. LOUIS, MISSOURI 63128
 (314) 467-0440 FAX 487-8944
 E-Mail: Sterling@stco-stl.net

DRAWN: _____
 DESIGNED: _____
 CHECKED: _____
 PROJECT: **BRIARCHASE PHASE TWO**
 SHEET TITLE: **CONSTRUCTION DETAILS**

NO.	02	03	043
M.S.D.			SHEET
PH			CD6
DIGITAL FILE LOCATION	SERVER=STERLING-2		
BOOKMARK (DWG)	OF		