

INSIDE FOUL WATER DROP MANHOLE (FOR FREE-FALL)
 METROPOLITAN ST. LOUIS SEWER DISTRICT
 Standard Details of Sewer Construction
 D. B. HANCOCK
 C. J. C. R.
 2000 SHEET 19

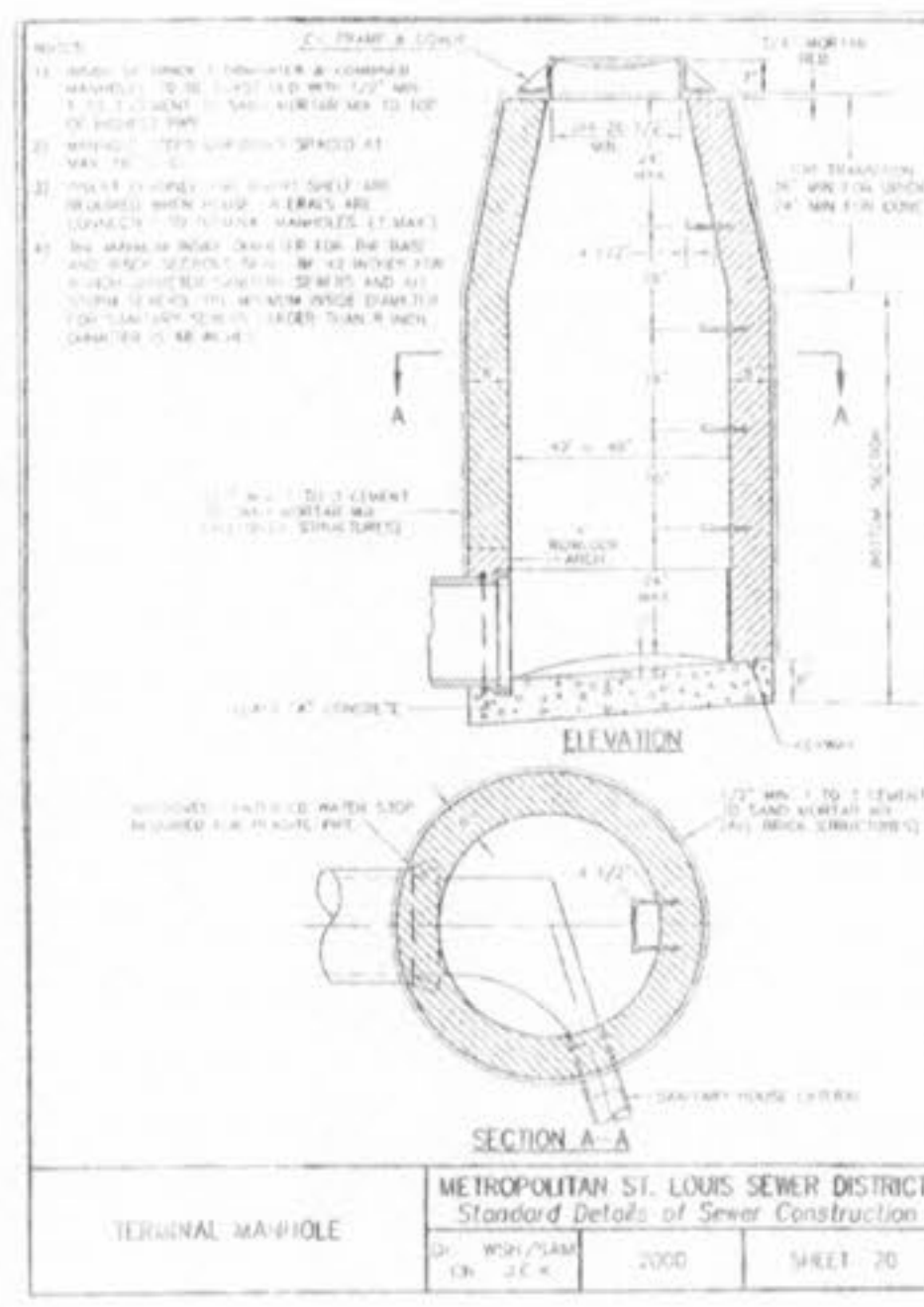

TERMINAL MANHOLE
 METROPOLITAN ST. LOUIS SEWER DISTRICT
 Standard Details of Sewer Construction
 D. B. HANCOCK
 C. J. C. R.
 2000 SHEET 20

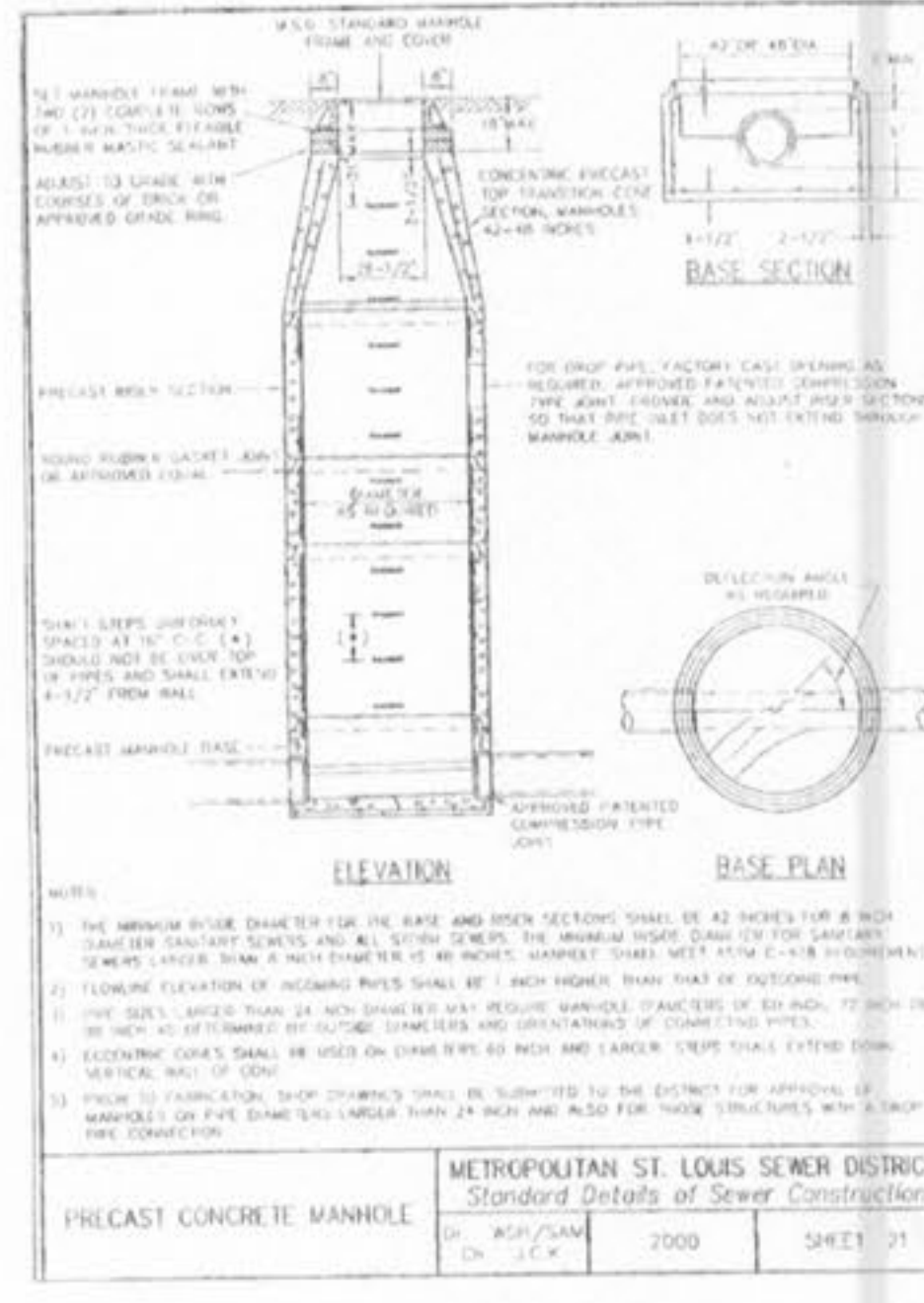

PRECAST CONCRETE MANHOLE
 METROPOLITAN ST. LOUIS SEWER DISTRICT
 Standard Details of Sewer Construction
 D. B. HANCOCK
 C. J. C. R.
 2000 SHEET 21

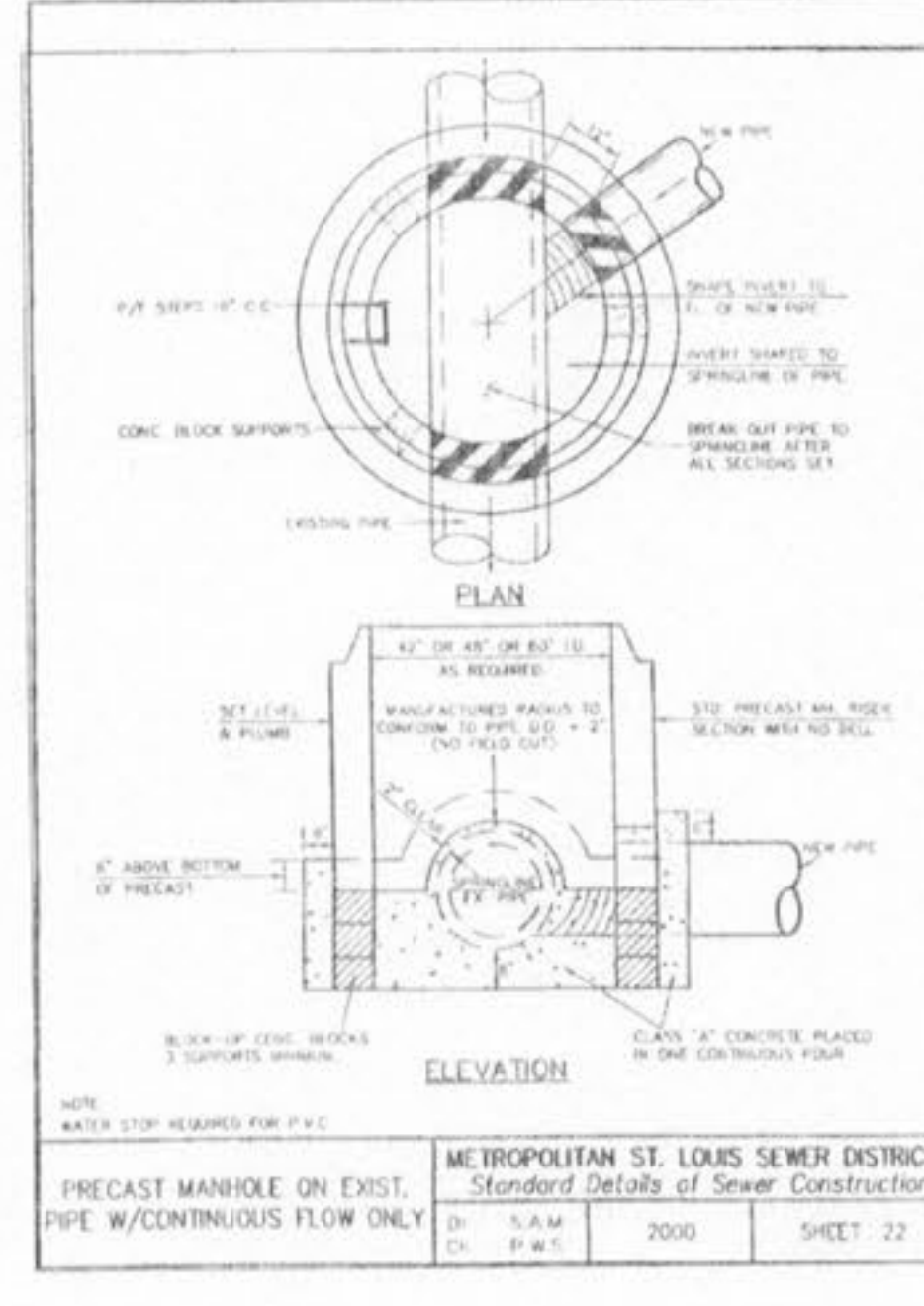

PRECAST MANHOLE ON EXIST. PIPE W/CONTINUOUS FLOW ONLY
 METROPOLITAN ST. LOUIS SEWER DISTRICT
 Standard Details of Sewer Construction
 D. B. HANCOCK
 C. J. C. R.
 2000 SHEET 22

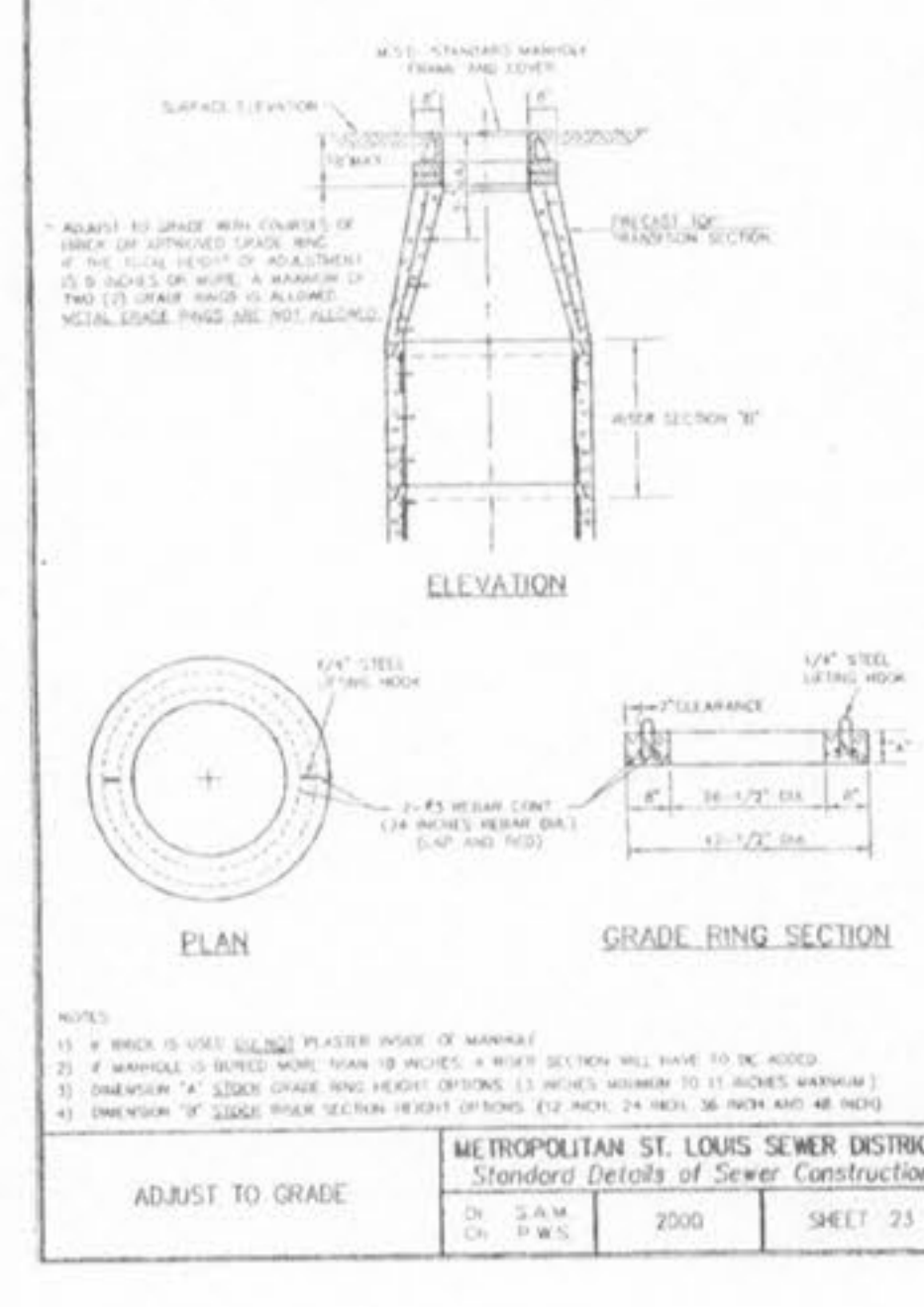

ADJUST TO GRADE
 METROPOLITAN ST. LOUIS SEWER DISTRICT
 Standard Details of Sewer Construction
 D. B. HANCOCK
 C. J. C. R.
 2000 SHEET 23

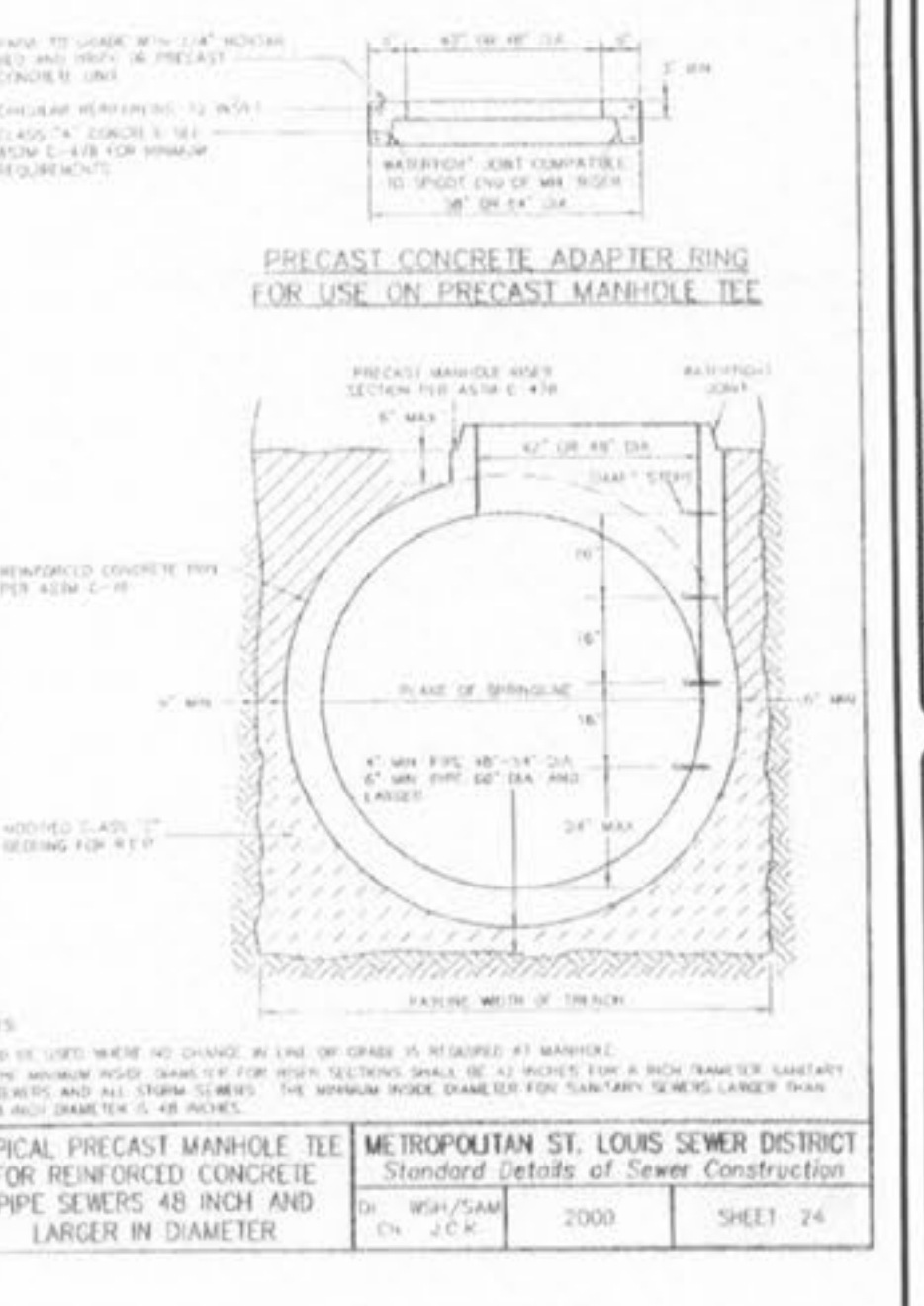

TYPICAL PRECAST MANHOLE TEE FOR REINFORCED CONCRETE PIPE 48 INCH AND LARGER IN DIAMETER
 METROPOLITAN ST. LOUIS SEWER DISTRICT
 Standard Details of Sewer Construction
 D. B. HANCOCK
 C. J. C. R.
 2000 SHEET 24

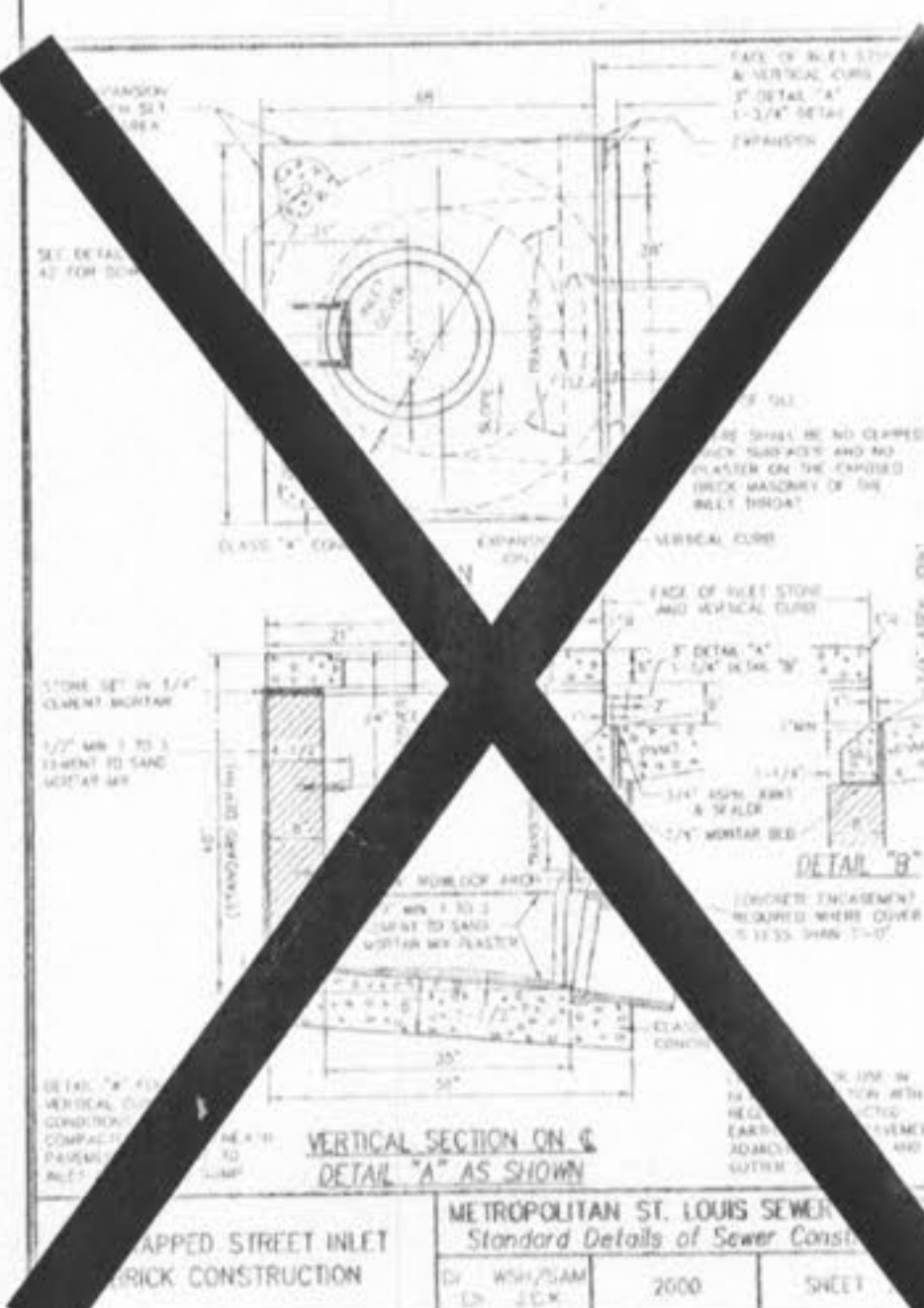

TRAPPED STREET INLET BRICK CONSTRUCTION
 METROPOLITAN ST. LOUIS SEWER DISTRICT
 Standard Details of Sewer Construction
 D. B. HANCOCK
 C. J. C. R.
 2000 SHEET 25

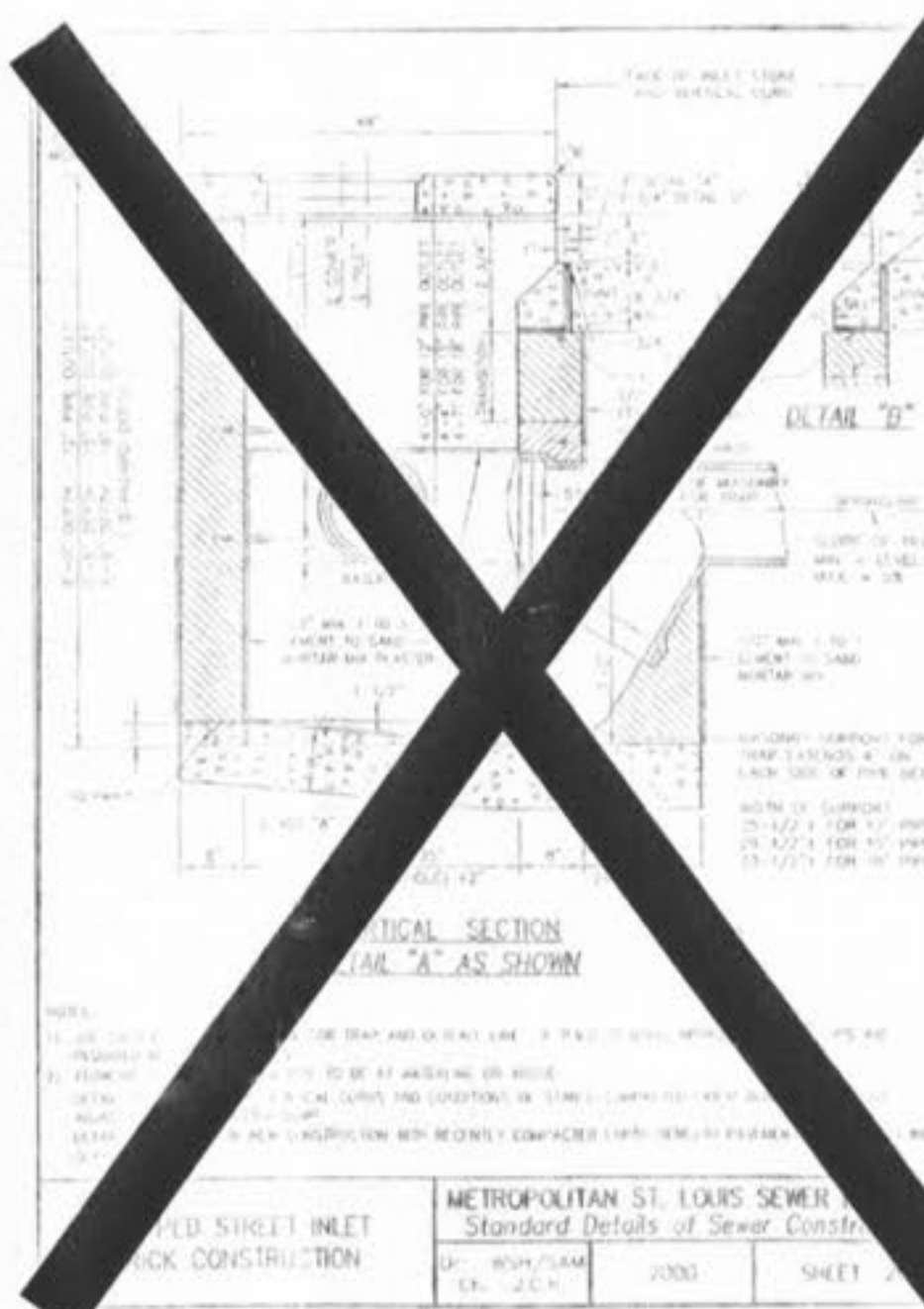

STREET INLET BRICK CONSTRUCTION
 METROPOLITAN ST. LOUIS SEWER DISTRICT
 Standard Details of Sewer Construction
 D. B. HANCOCK
 C. J. C. R.
 2000 SHEET 26

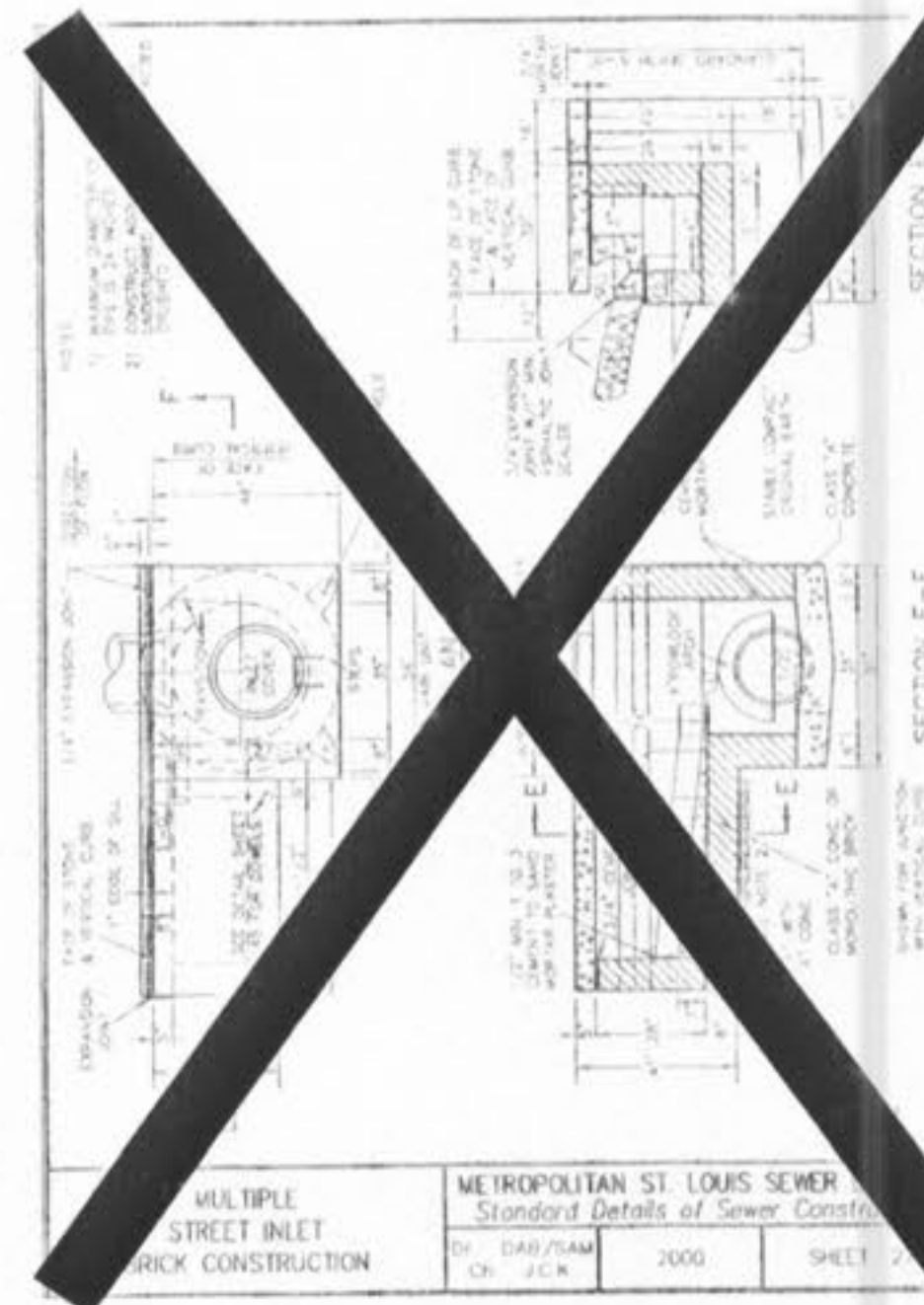

MULTIPLE STREET INLET BRICK CONSTRUCTION
 METROPOLITAN ST. LOUIS SEWER DISTRICT
 Standard Details of Sewer Construction
 D. B. HANCOCK
 C. J. C. R.
 2000 SHEET 27

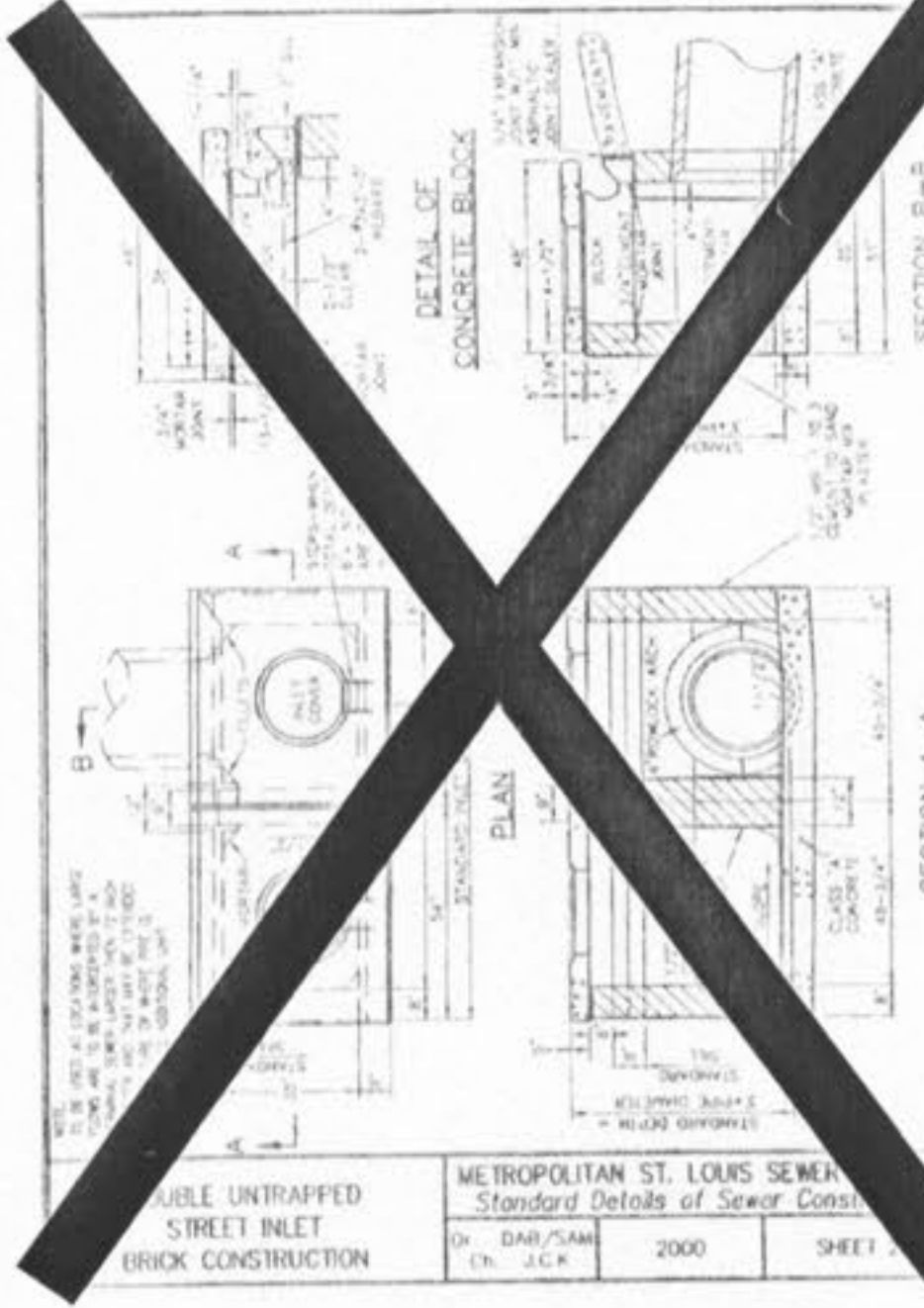

STREET INLET BRICK CONSTRUCTION
 METROPOLITAN ST. LOUIS SEWER DISTRICT
 Standard Details of Sewer Construction
 D. B. HANCOCK
 C. J. C. R.
 2000 SHEET 28

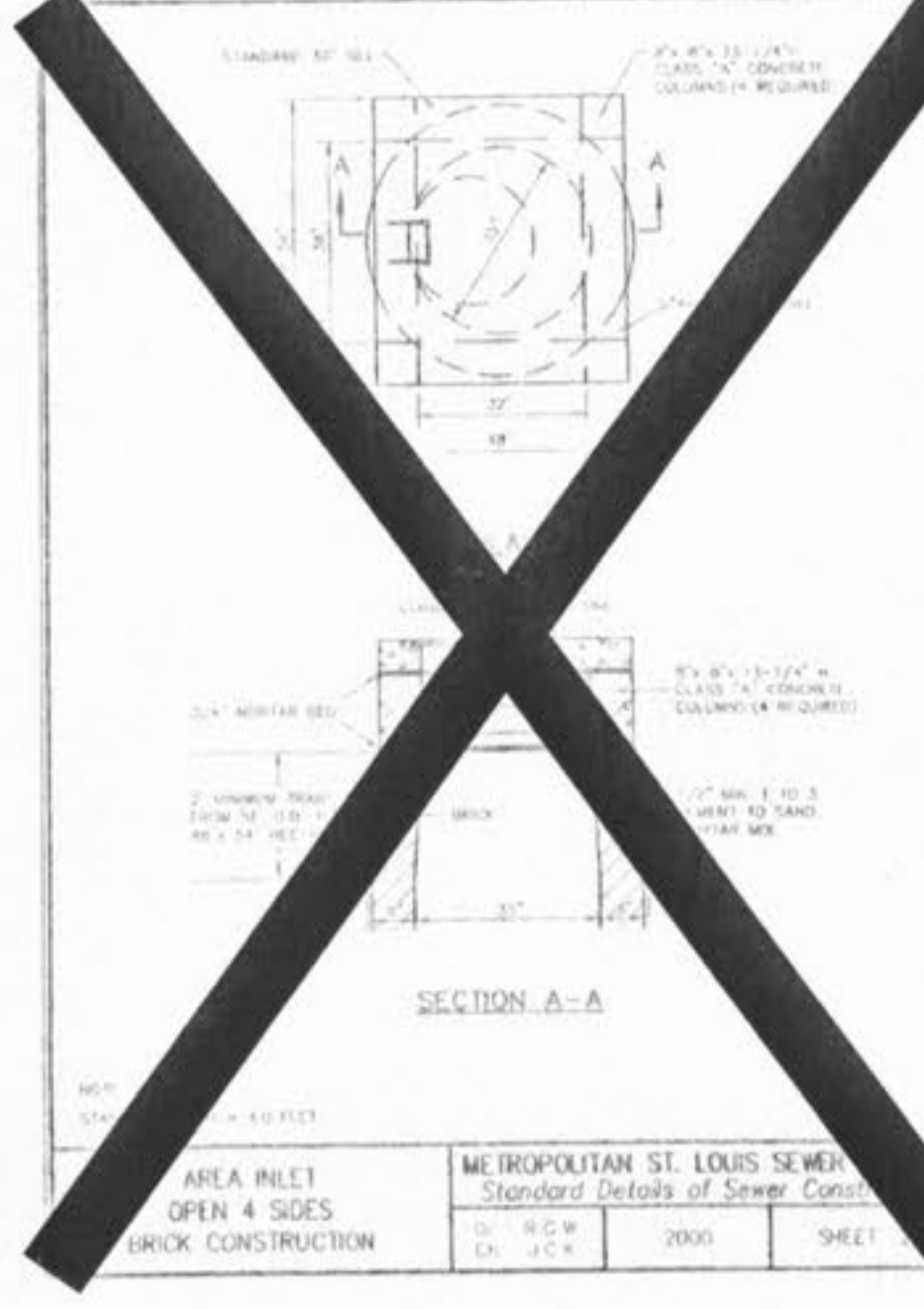

AREA INLET OPEN 4 SIDES BRICK CONSTRUCTION
 METROPOLITAN ST. LOUIS SEWER DISTRICT
 Standard Details of Sewer Construction
 D. B. HANCOCK
 C. J. C. R.
 2000 SHEET 29

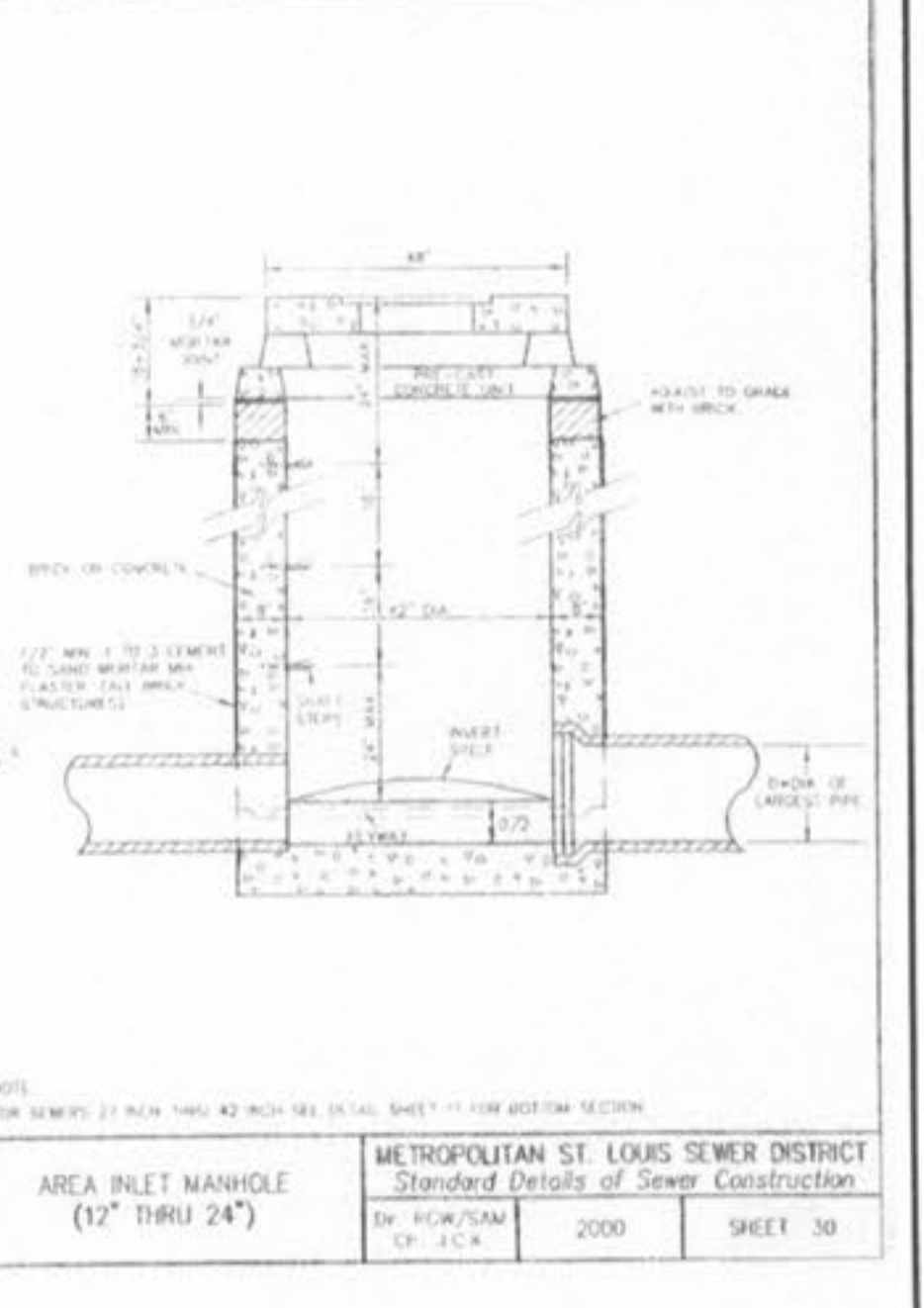

AREA INLET MANHOLE (12" THRU 24")
 METROPOLITAN ST. LOUIS SEWER DISTRICT
 Standard Details of Sewer Construction
 D. B. HANCOCK
 C. J. C. R.
 2000 SHEET 30

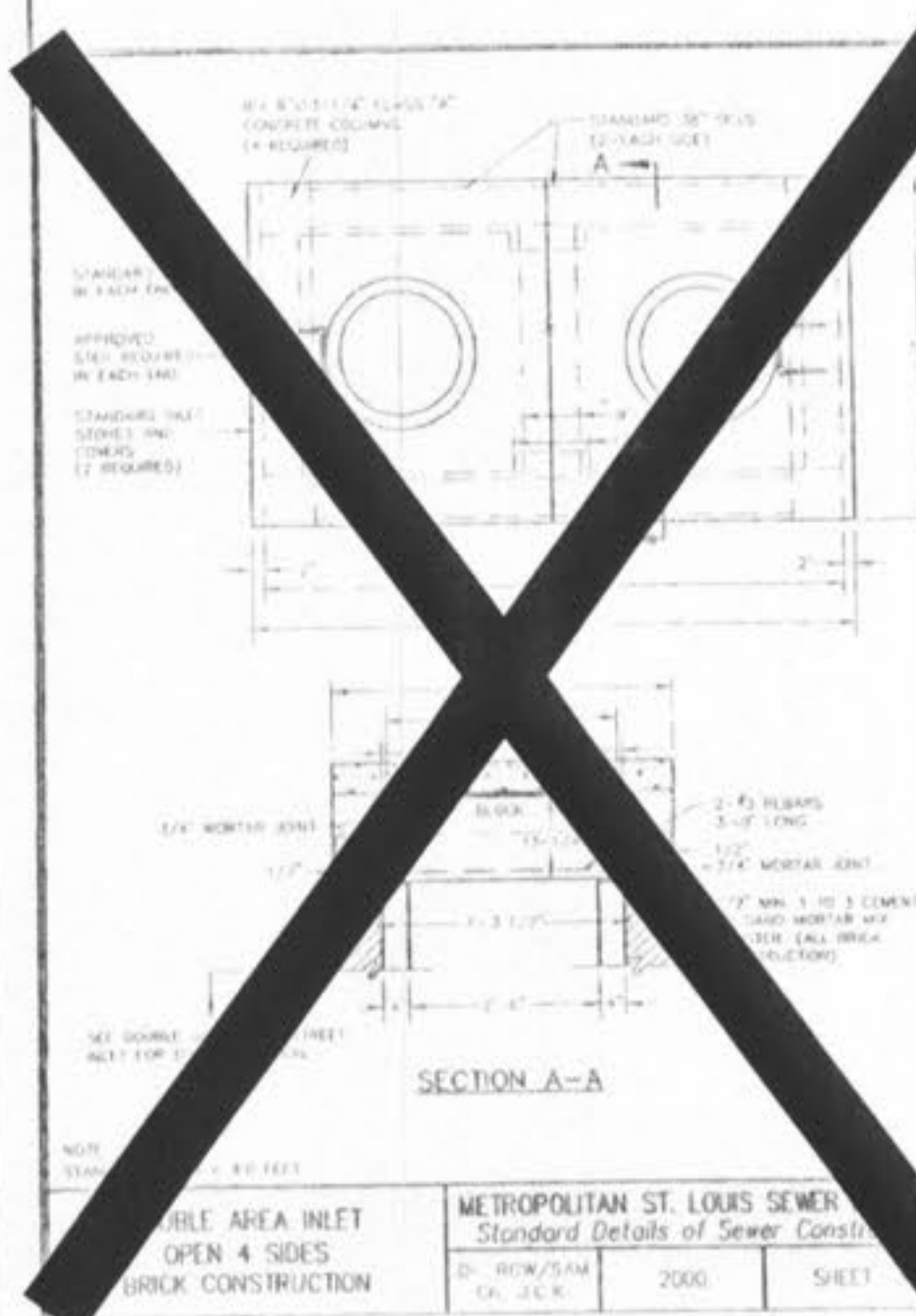

MULTIPLE AREA INLET OPEN 4 SIDES BRICK CONSTRUCTION
 METROPOLITAN ST. LOUIS SEWER DISTRICT
 Standard Details of Sewer Construction
 D. B. HANCOCK
 C. J. C. R.
 2000 SHEET 31

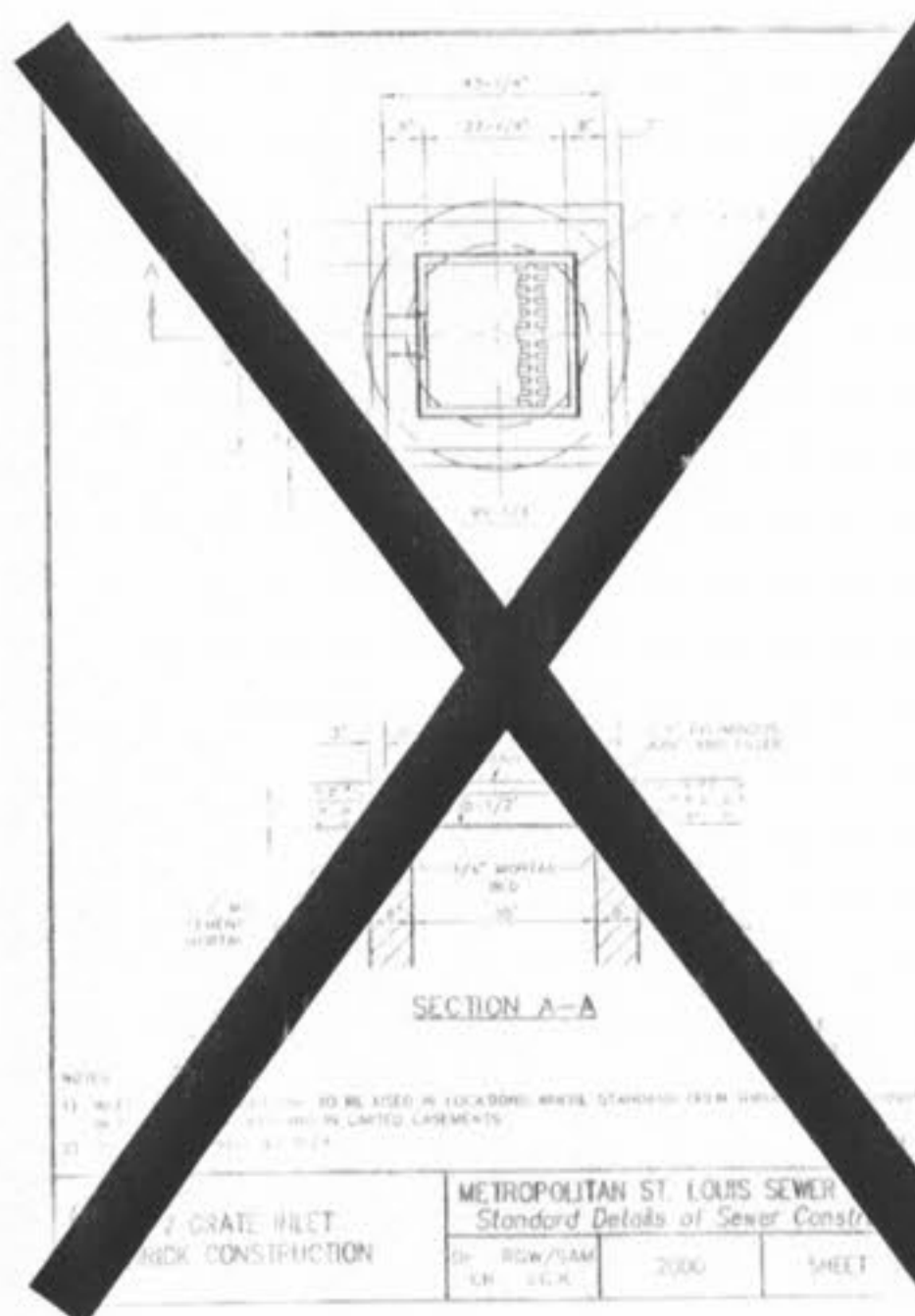

GRATE INLET BRICK CONSTRUCTION
 METROPOLITAN ST. LOUIS SEWER DISTRICT
 Standard Details of Sewer Construction
 D. B. HANCOCK
 C. J. C. R.
 2000 SHEET 32

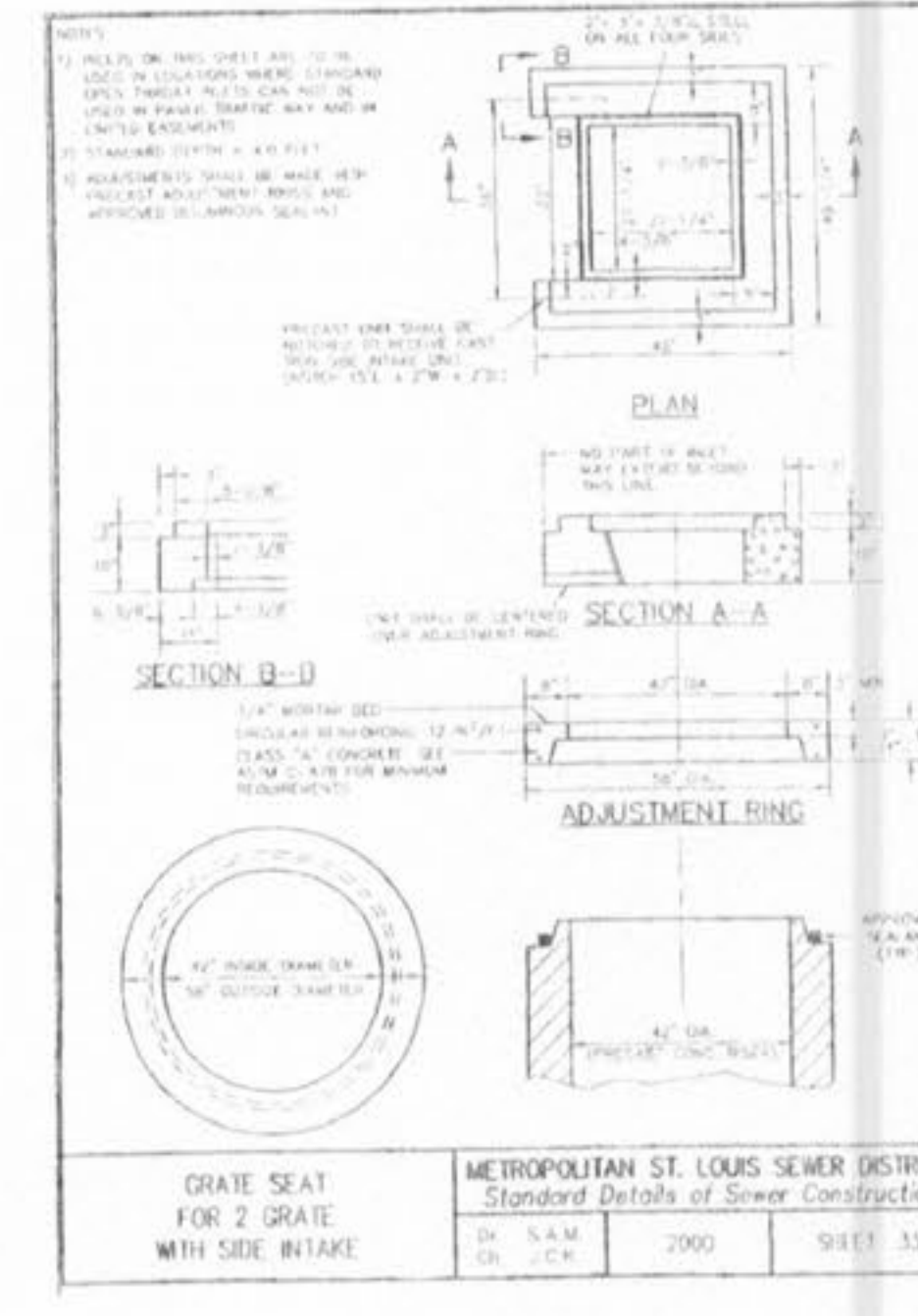

GRATE SEAT FOR 2 GRATE WITH SIDE INTAKE
 METROPOLITAN ST. LOUIS SEWER DISTRICT
 Standard Details of Sewer Construction
 D. B. HANCOCK
 C. J. C. R.
 2000 SHEET 33

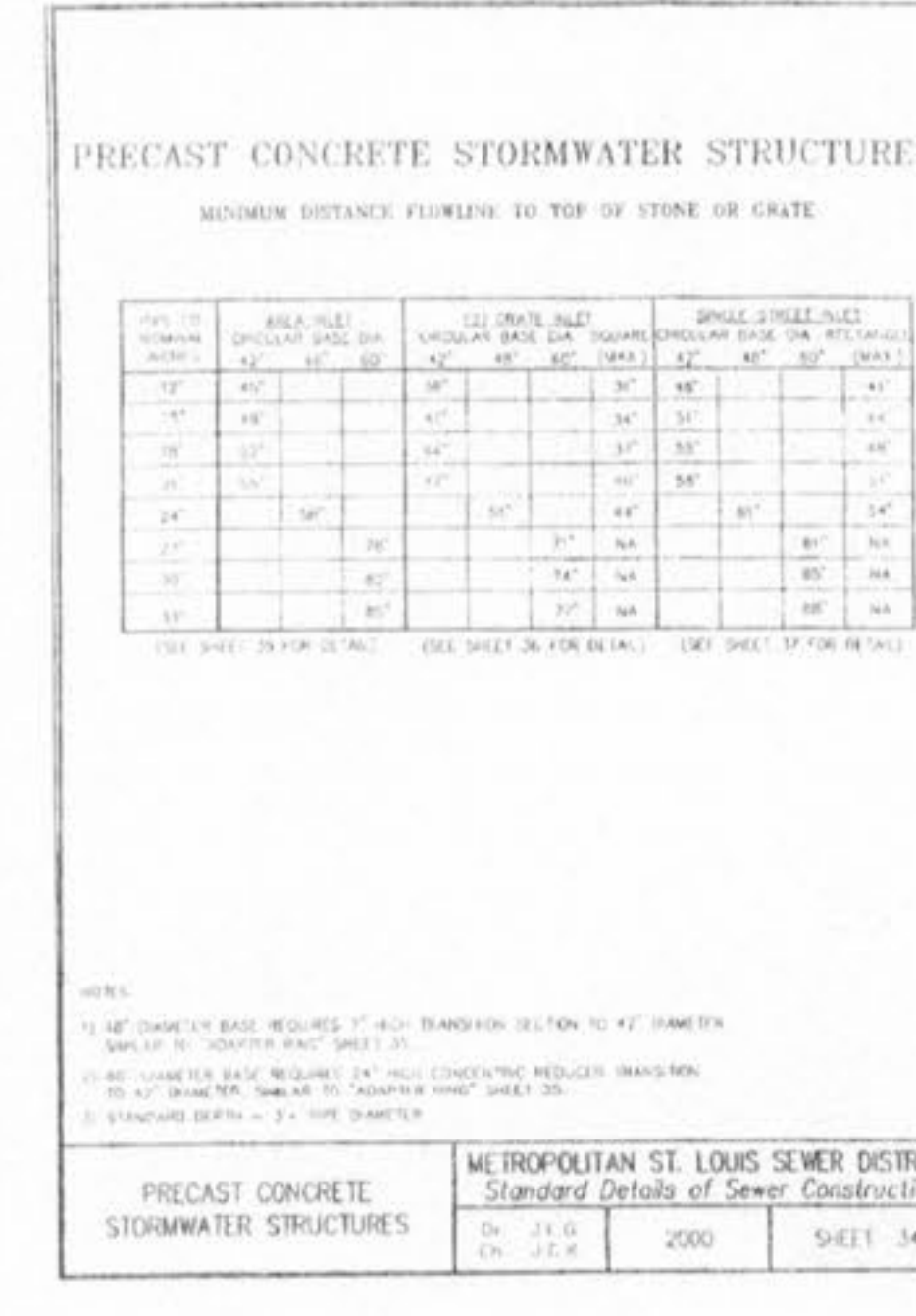

PRECAST CONCRETE STORMWATER STRUCTURES
 METROPOLITAN ST. LOUIS SEWER DISTRICT
 Standard Details of Sewer Construction
 D. B. HANCOCK
 C. J. C. R.
 2000 SHEET 34

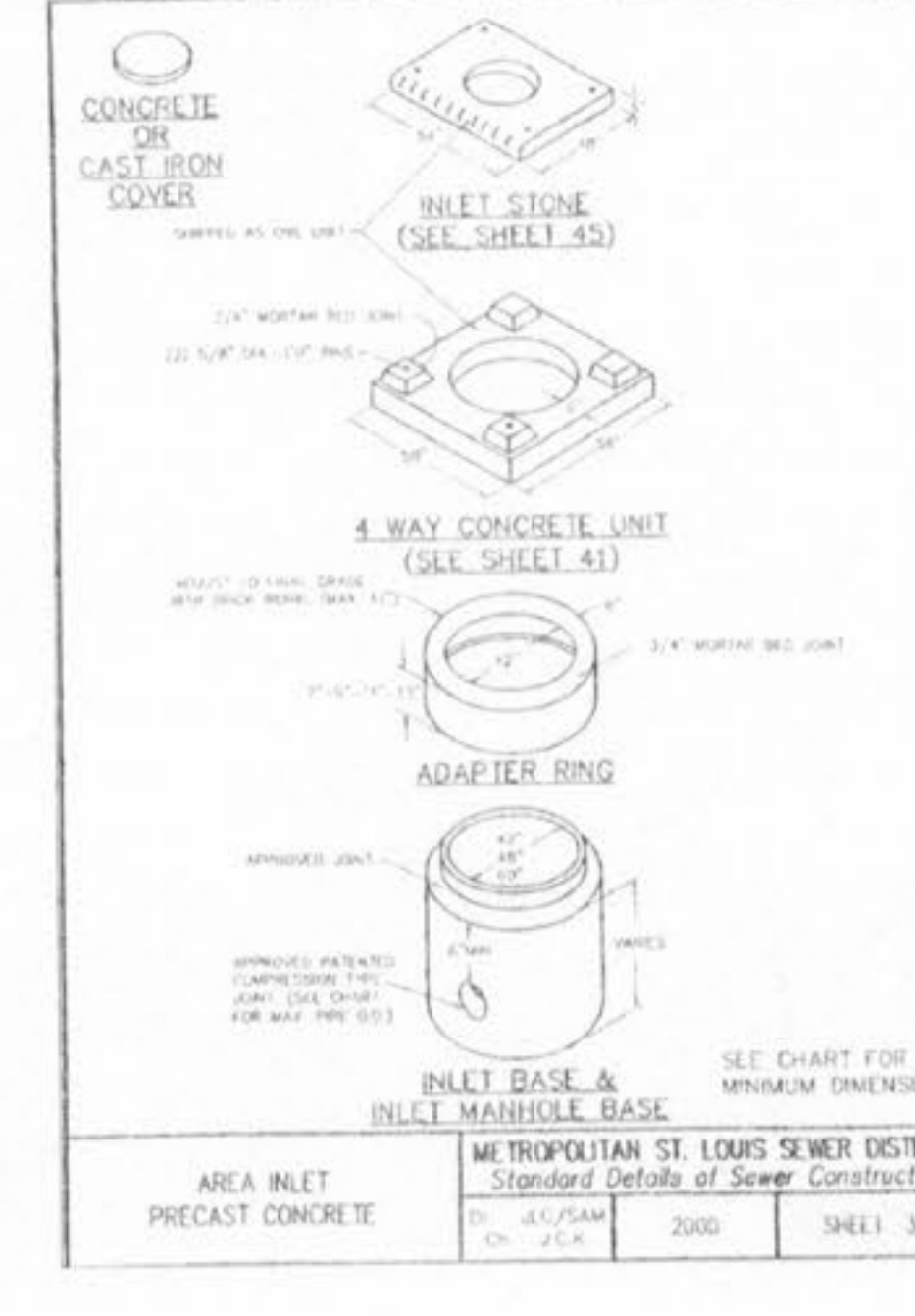

CONCRETE OR CAST IRON COVER
 AREA INLET PRECAST CONCRETE
 METROPOLITAN ST. LOUIS SEWER DISTRICT
 Standard Details of Sewer Construction
 D. B. HANCOCK
 C. J. C. R.
 2000 SHEET 35

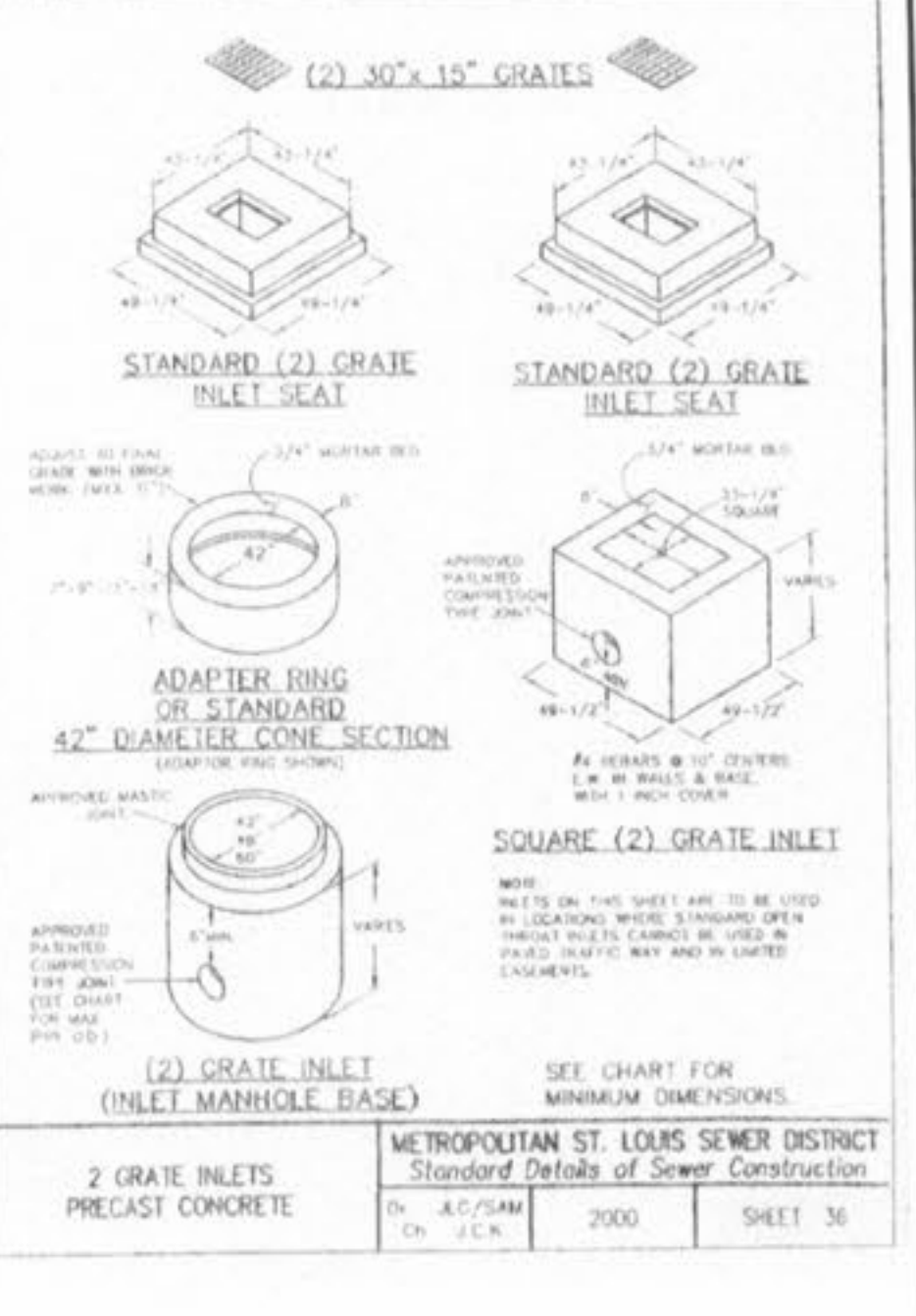

(2) 30" x 15" GRATES
 2 GRATE INLETS PRECAST CONCRETE
 METROPOLITAN ST. LOUIS SEWER DISTRICT
 Standard Details of Sewer Construction
 D. B. HANCOCK
 C. J. C. R.
 2000 SHEET 36

ISSUE REMARKS/DATE

1	11-14-02 1st Submittal
---	------------------------

PREPARED FOR:
McBride & Son Home, Inc.
 #1 McBride & Son Center Drive
 Chesterfield, Missouri 63005
 (636) 537-2000

THE **STERLING** CO.
 ENGINEERS & SURVEYORS
 5065 NEW BAUMGARTNER ROAD
 ST. LOUIS, MISSOURI 63129
 (314) 487-0440 FAX: 487-4864
 E-Mail: Sterling@comcast.net

PROJECT: **BRIARCHASE**

DRAWN: [Signature] DESIGNED: [Signature] CHECKED: RLA

SHEET TITLE: CONSTRUCTION DETAILS

NO. 02	03	043
M.S.D.	SHEET	
P#	CD4	
DIGITAL FILE LOCATION: SEWER-STERLING-2	OF	