

LOCKING DEVICE FOR TYPE "T" LOCK TYPE MANHOLE COVER
 METROPOLITAN ST. LOUIS SEWER DISTRICT
 Standard Details of Sewer Construction
 D. W. H. / J. C. K. 2000 SHEET 55

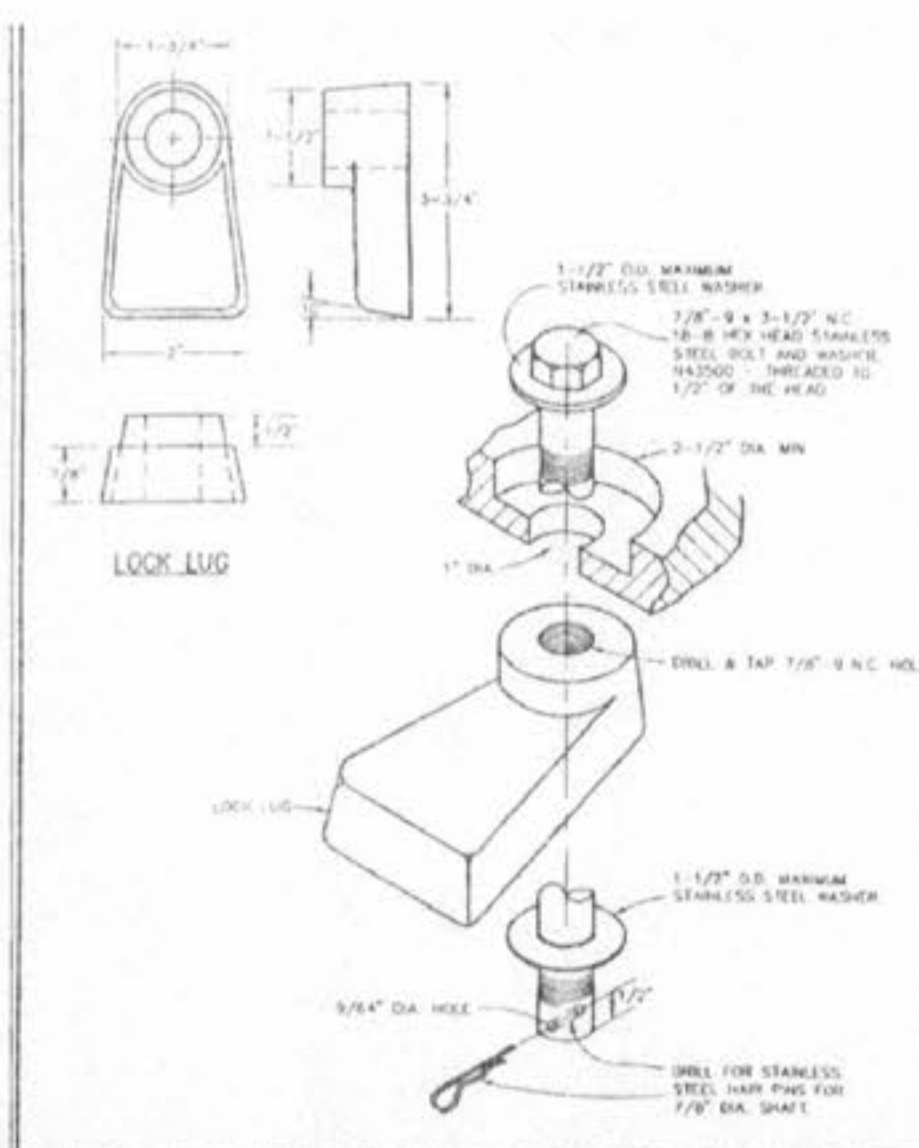

LOCKING DEVICE FOR TYPE "N" LOCK TYPE MANHOLE COVER
 METROPOLITAN ST. LOUIS SEWER DISTRICT
 Standard Details of Sewer Construction
 D. W. H. / J. C. K. 2000 SHEET 56

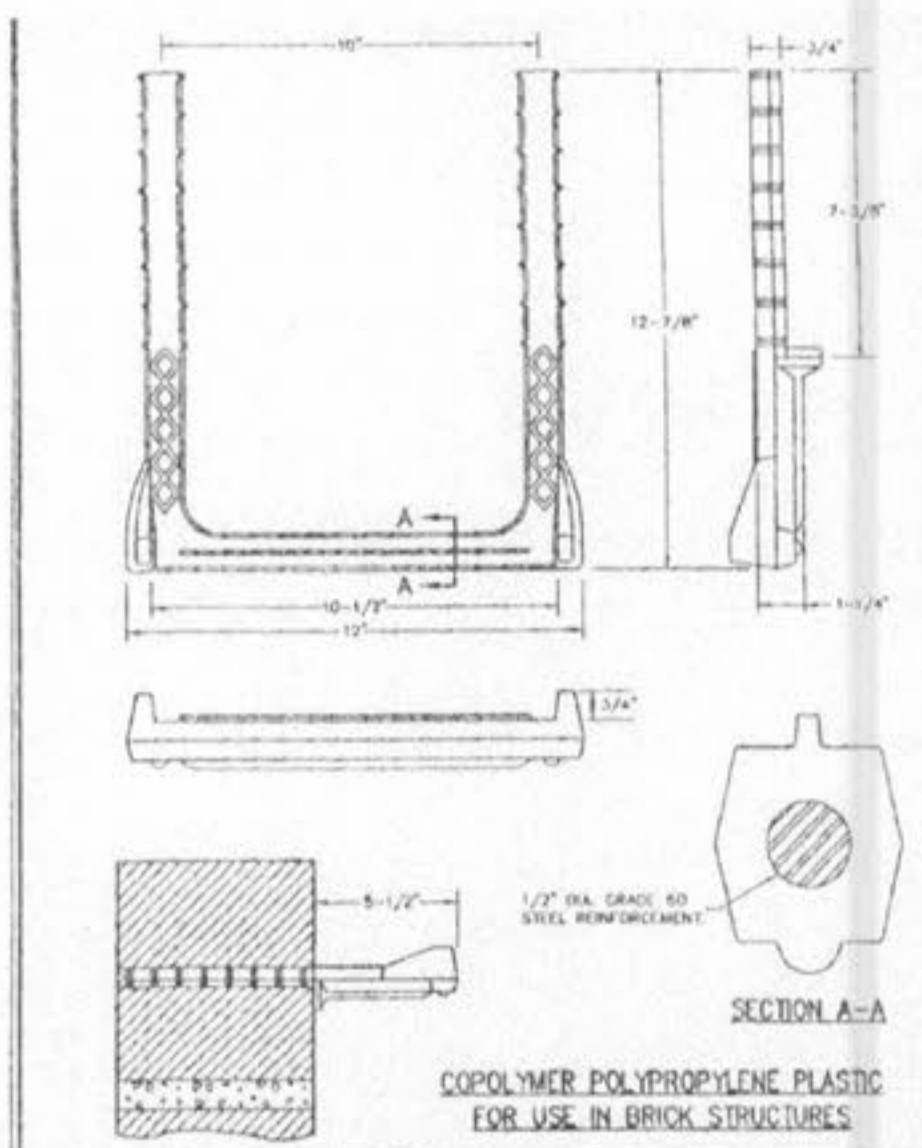

PSI-B MANHOLE STEP INTO JOINT
 METROPOLITAN ST. LOUIS SEWER DISTRICT
 Standard Details of Sewer Construction
 D. W. H. / J. C. K. 2000 SHEET 57

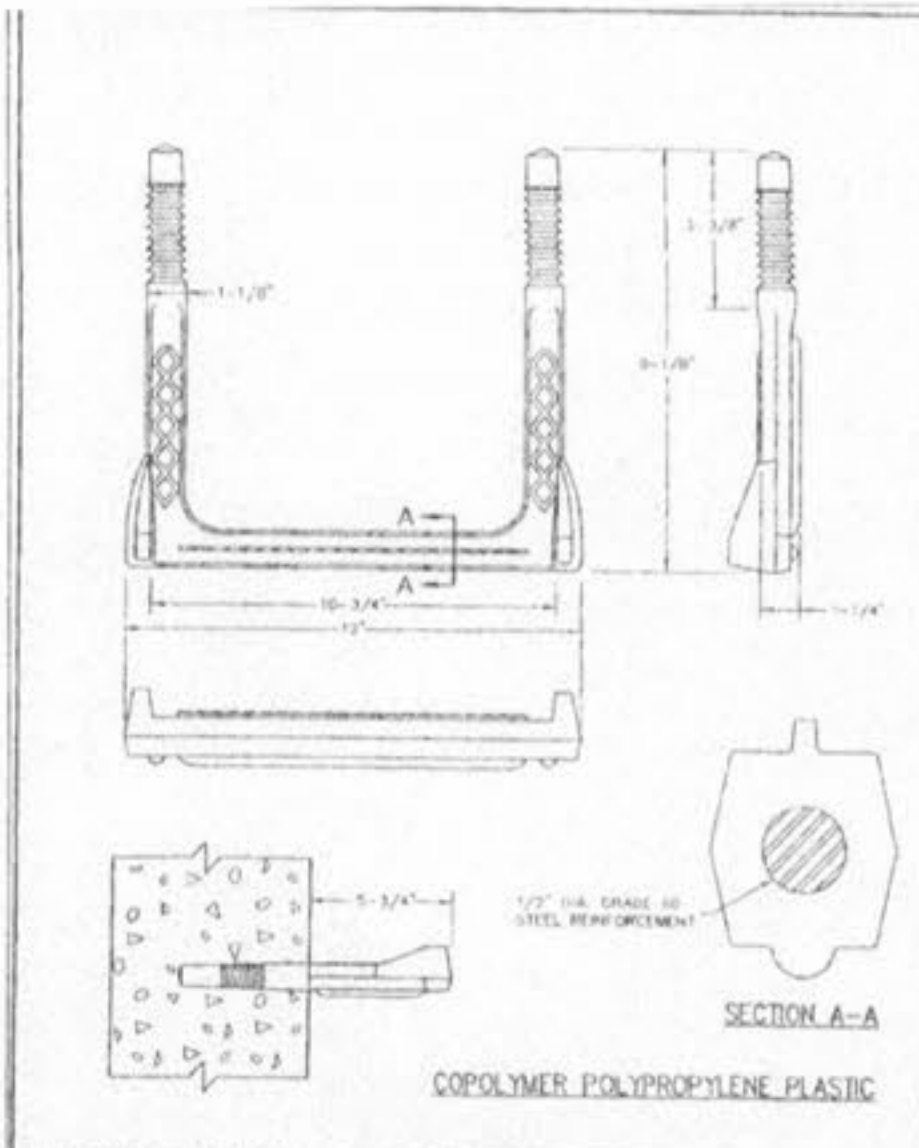

MANHOLE STEP FOR PRECAST & CAST-IN-PLACE MANHOLE
 METROPOLITAN ST. LOUIS SEWER DISTRICT
 Standard Details of Sewer Construction
 D. W. H. / J. C. K. 2000 SHEET 58

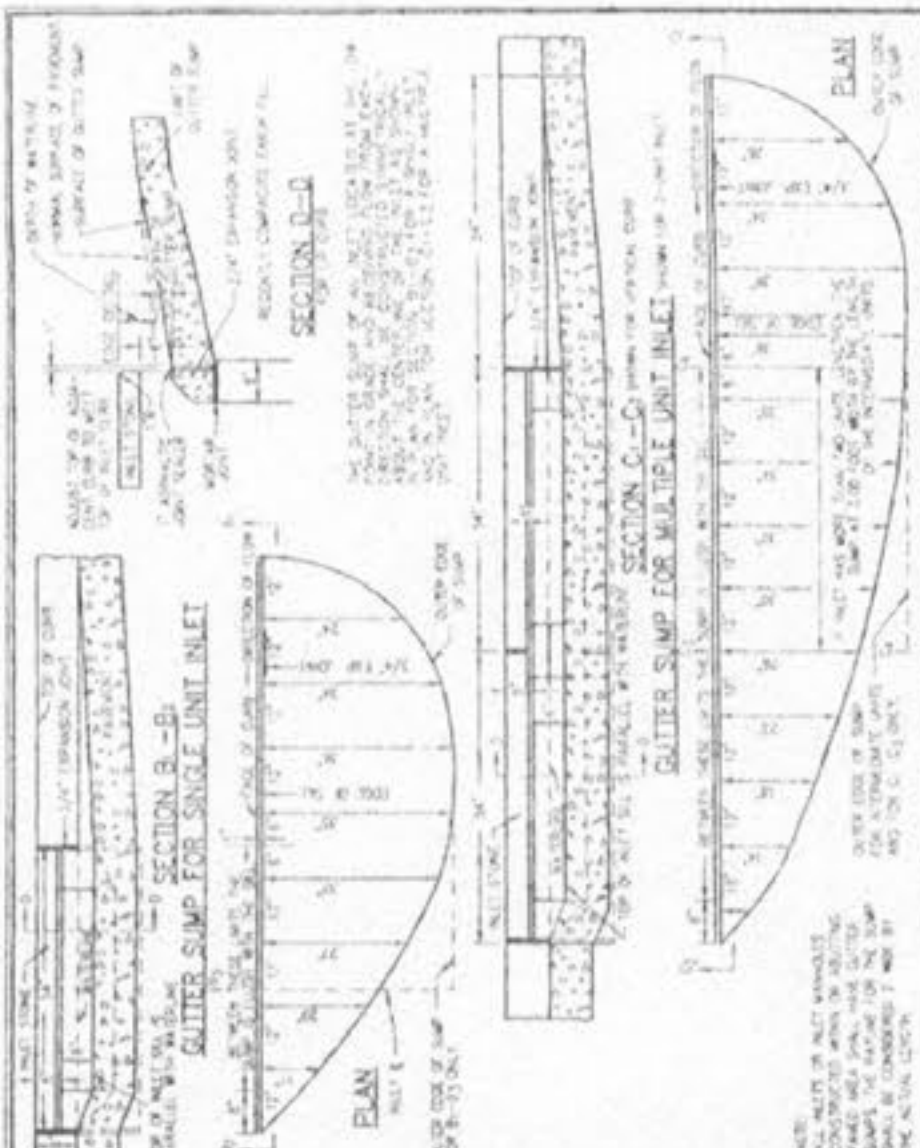

GUTTER SUMPS FOR VERTICAL CURB
 METROPOLITAN ST. LOUIS SEWER DISTRICT
 Standard Details of Sewer Construction
 D. W. H. / J. C. K. 2000 SHEET 59

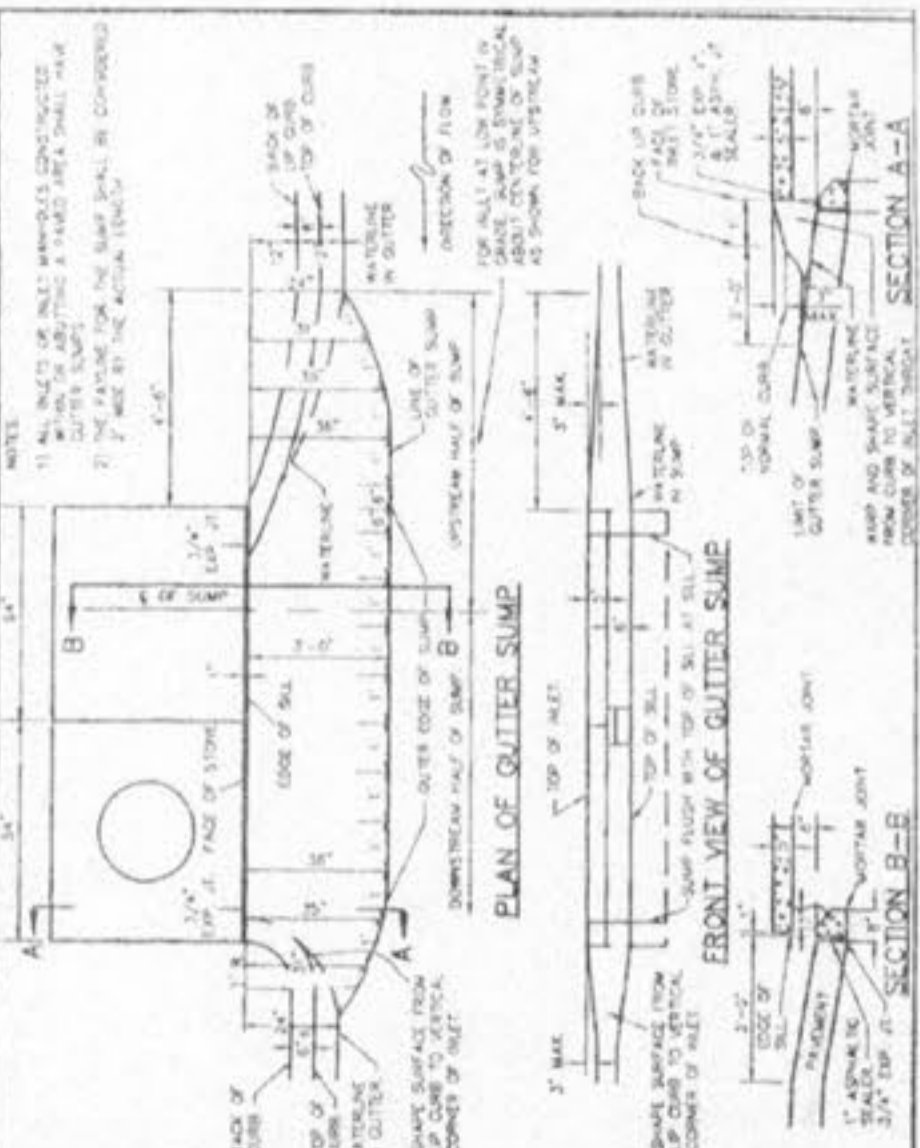

GUTTER SUMP FOR CURB
 METROPOLITAN ST. LOUIS SEWER DISTRICT
 Standard Details of Sewer Construction
 D. W. H. / J. C. K. 2000 SHEET 60

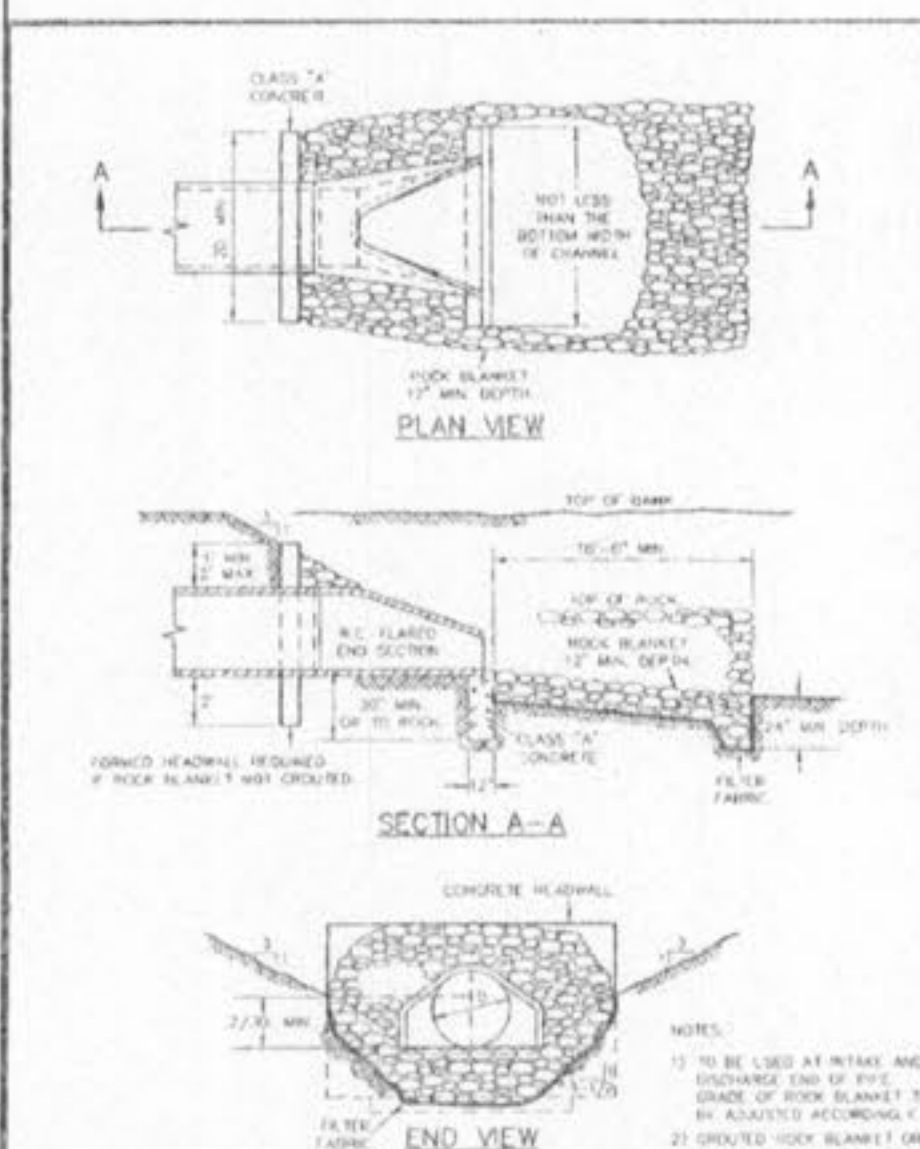

FLARED END SECTION
 METROPOLITAN ST. LOUIS SEWER DISTRICT
 Standard Details of Sewer Construction
 D. W. H. / J. C. K. 2000 SHEET 61

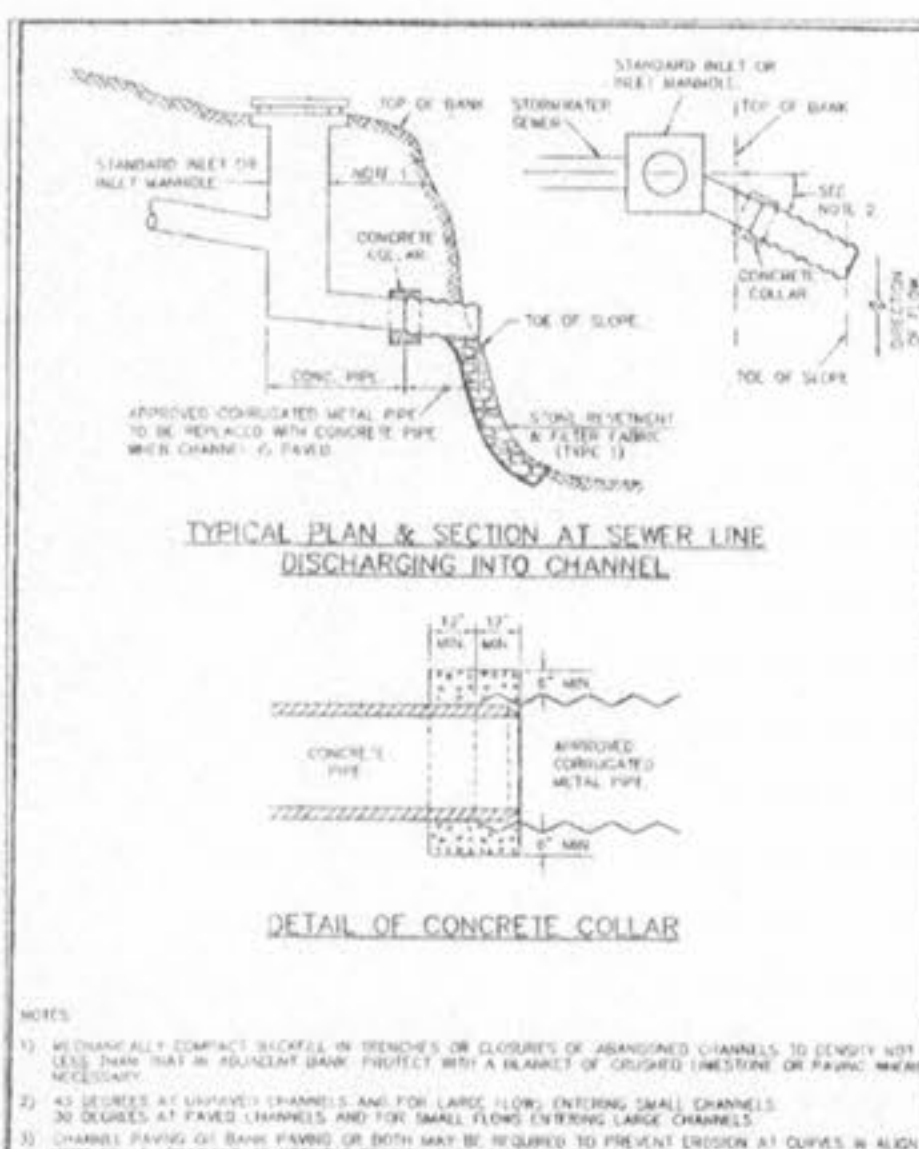

TYPICAL PLAN & SECTION AT SEWER LINE DISCHARGING INTO CHANNEL
 METROPOLITAN ST. LOUIS SEWER DISTRICT
 Standard Details of Sewer Construction
 D. W. H. / J. C. K. 2000 SHEET 62

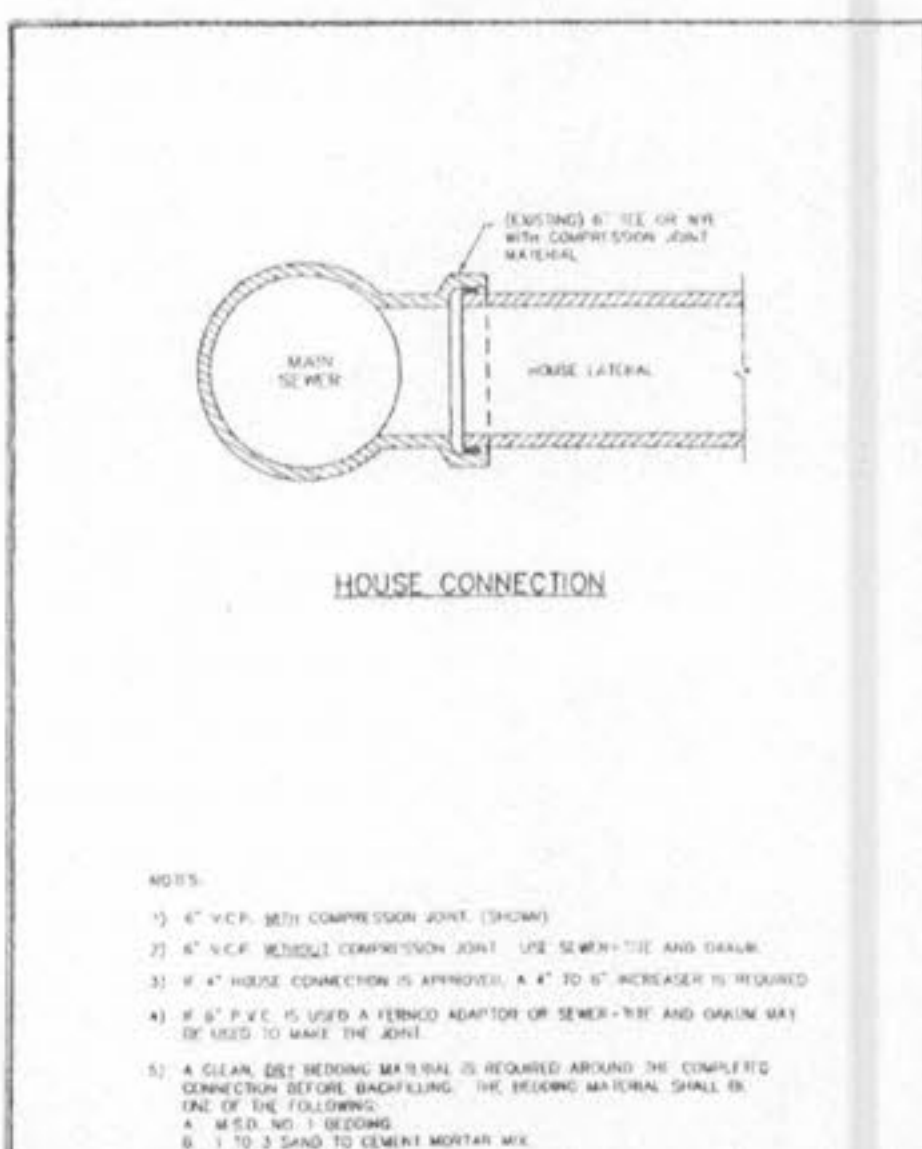

HOUSE CONNECTION
 METROPOLITAN ST. LOUIS SEWER DISTRICT
 Standard Details of Sewer Construction
 D. W. H. / J. C. K. 2000 SHEET 63

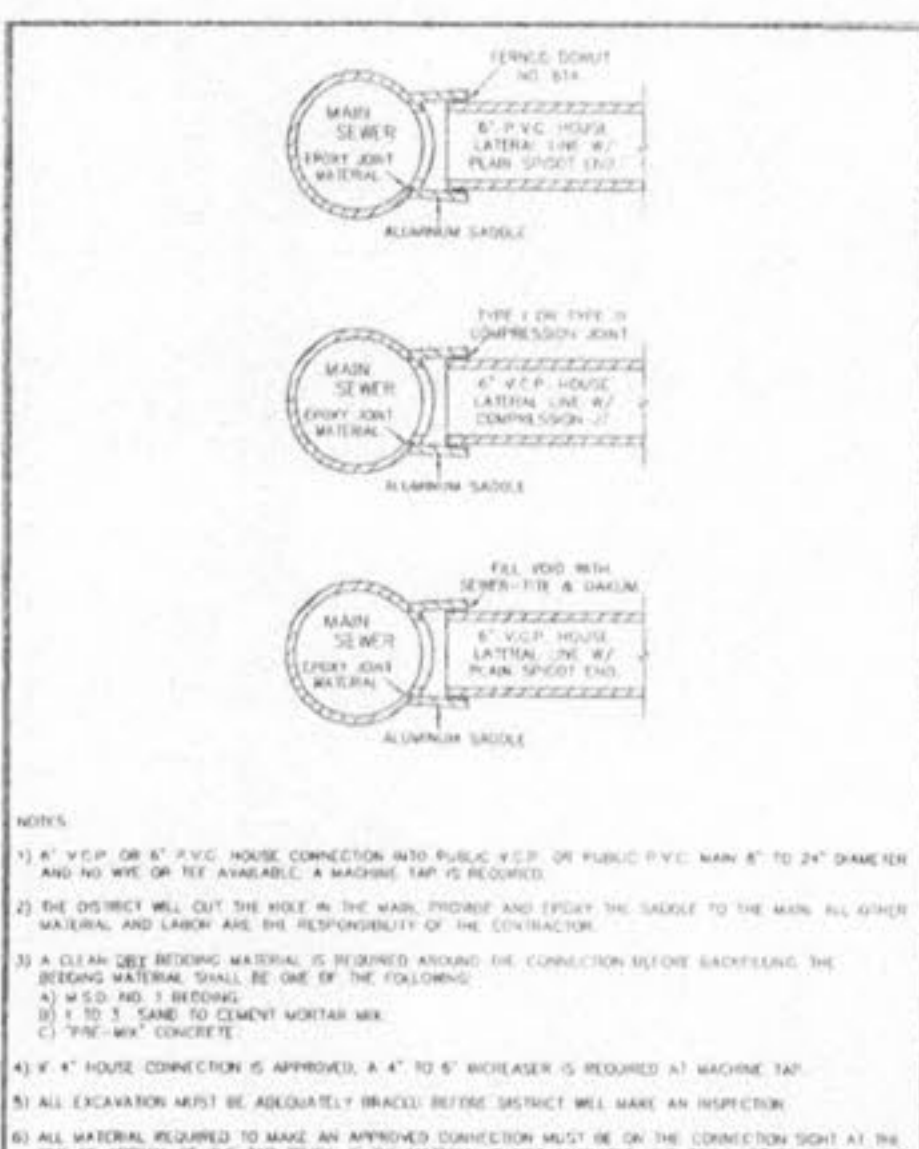

MACHINE TAP
 METROPOLITAN ST. LOUIS SEWER DISTRICT
 Standard Details of Sewer Construction
 D. W. H. / J. C. K. 2000 SHEET 64

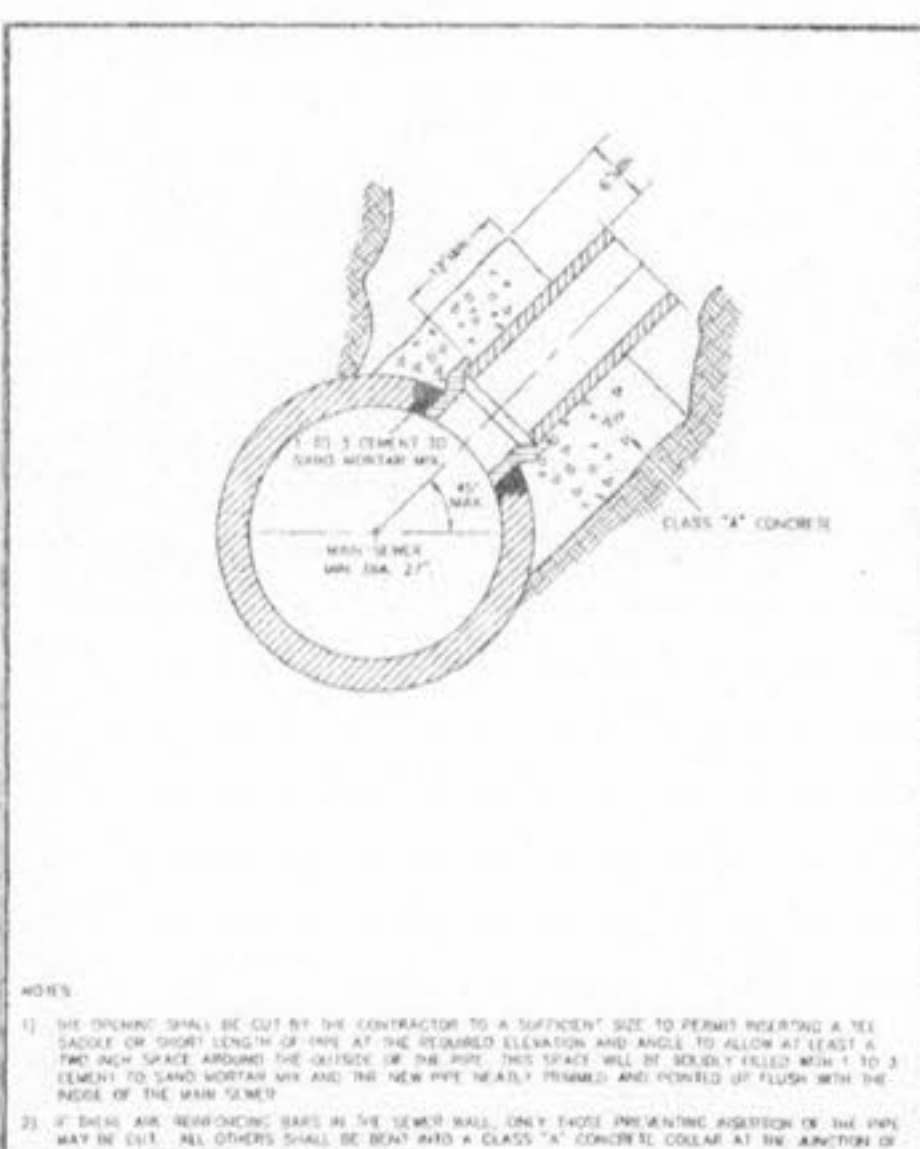

HOUSE CONNECTIONS ALLOWED BY TEE SADDLE
 METROPOLITAN ST. LOUIS SEWER DISTRICT
 Standard Details of Sewer Construction
 D. W. H. / J. C. K. 2000 SHEET 65

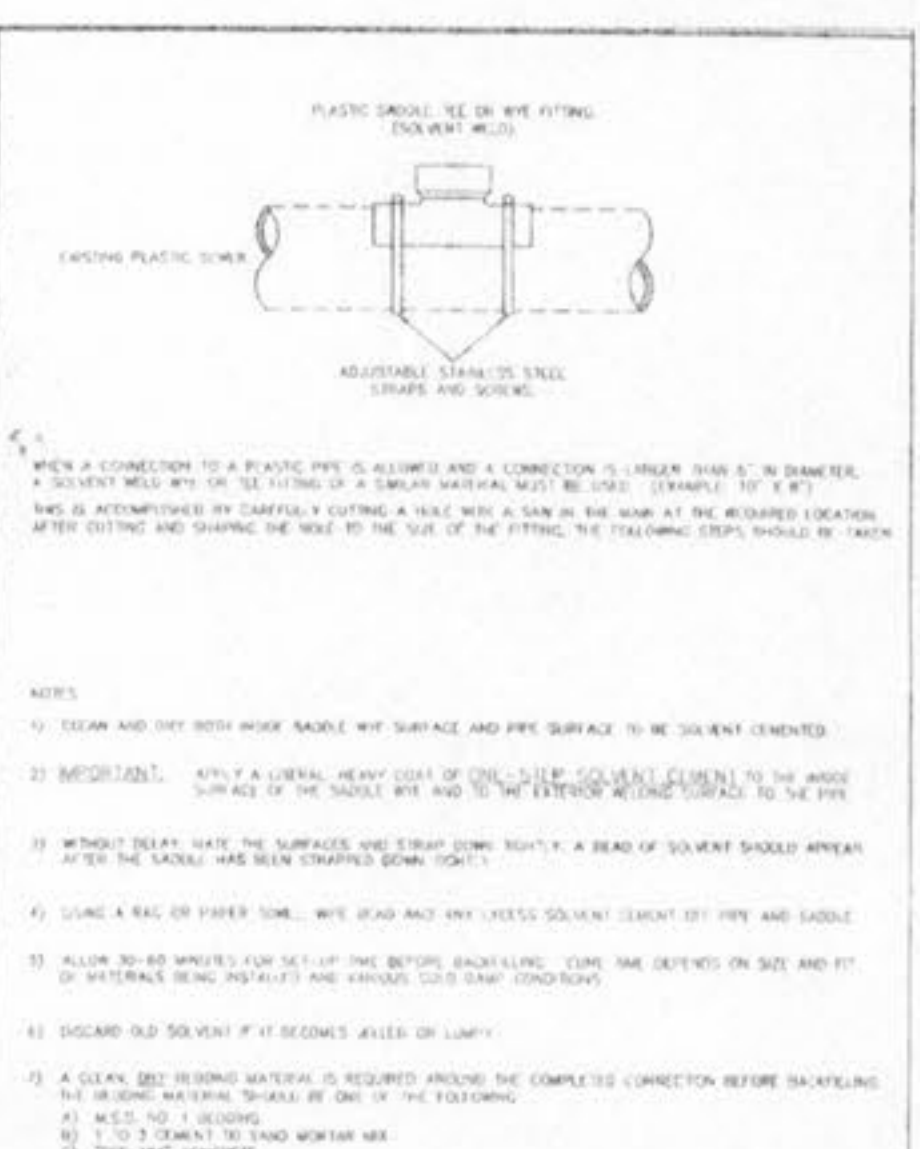

8" (& LARGER) CONNECTION TO PLASTIC MAIN
 METROPOLITAN ST. LOUIS SEWER DISTRICT
 Standard Details of Sewer Construction
 D. W. H. / J. C. K. 2000 SHEET 66

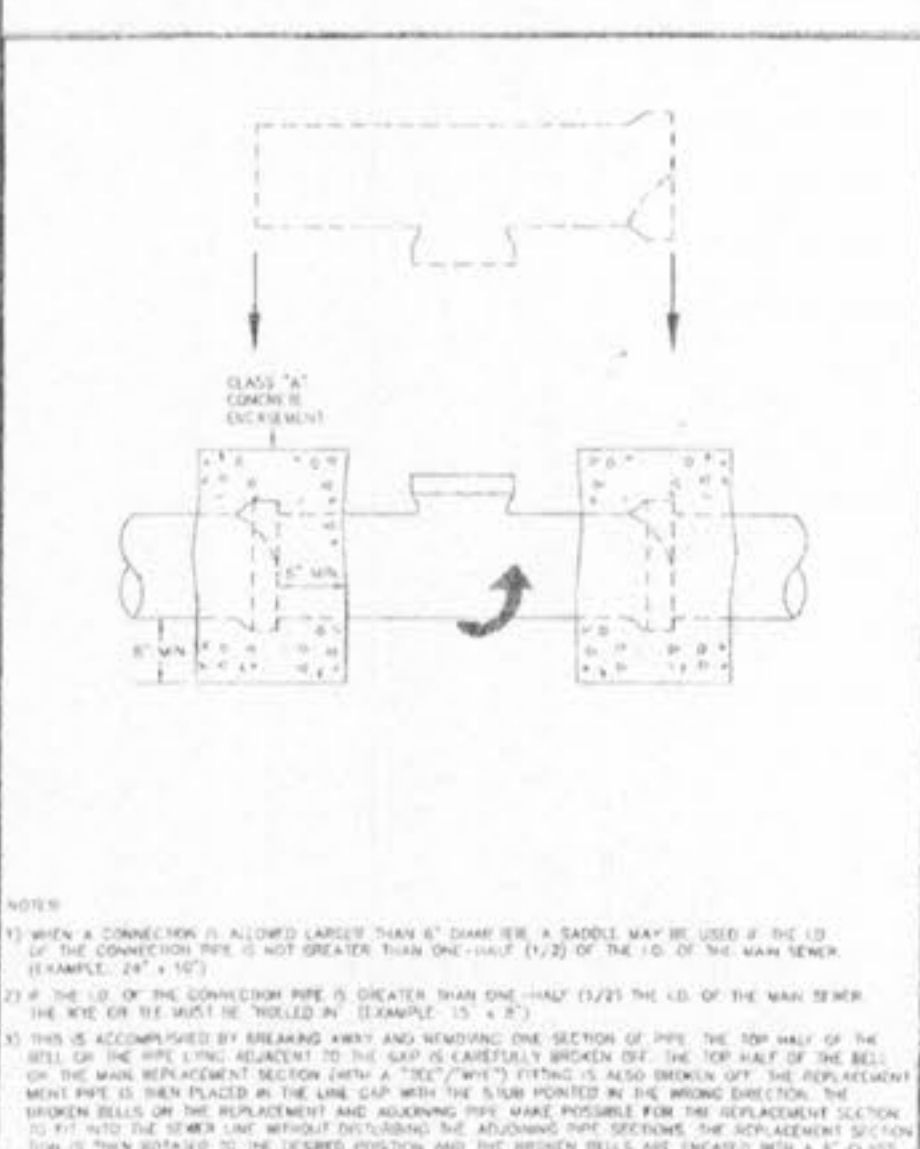

"ROLL-IN" (FOR EXISTING CLAY OR CONCRETE PIPE)
 METROPOLITAN ST. LOUIS SEWER DISTRICT
 Standard Details of Sewer Construction
 D. W. H. / J. C. K. 2000 SHEET 67

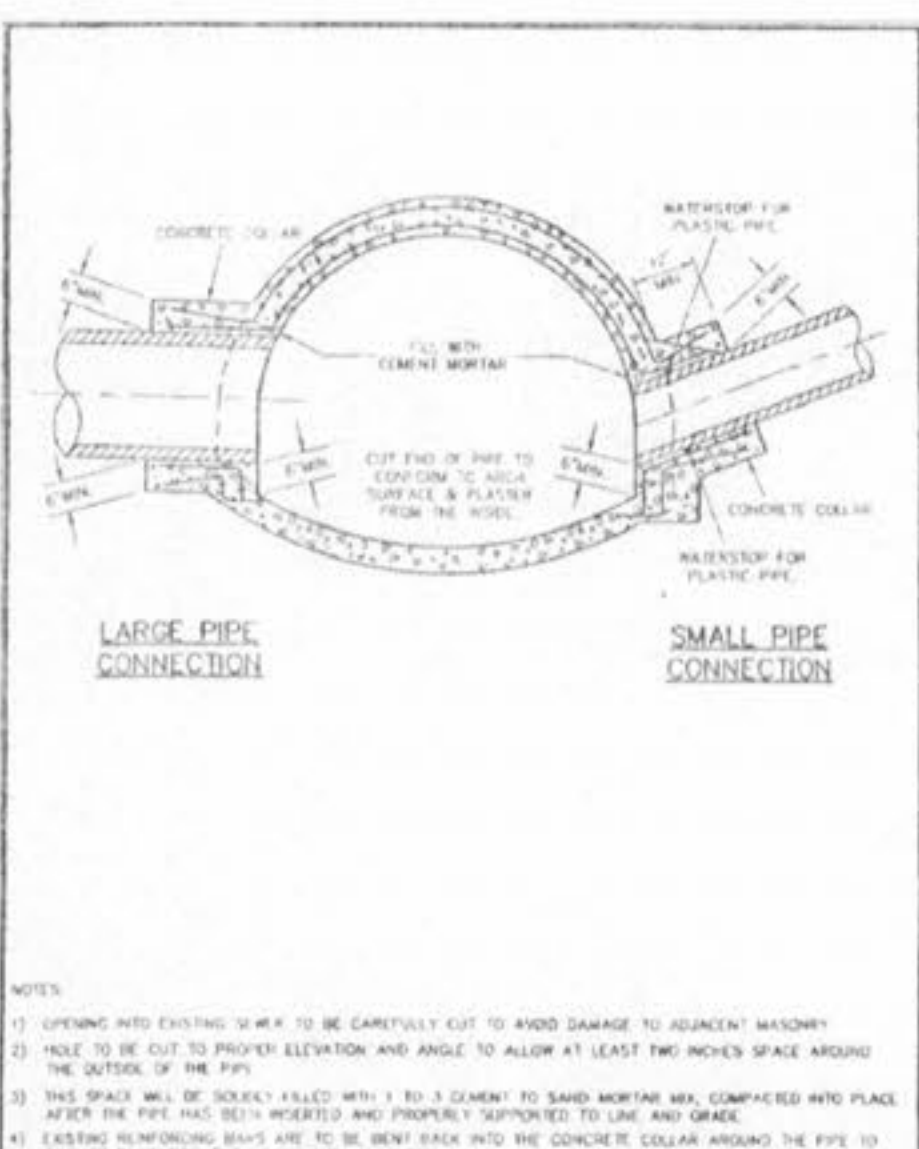

CONNECTIONS TO LARGE SEWERS
 METROPOLITAN ST. LOUIS SEWER DISTRICT
 Standard Details of Sewer Construction
 D. W. H. / J. C. K. 2000 SHEET 68

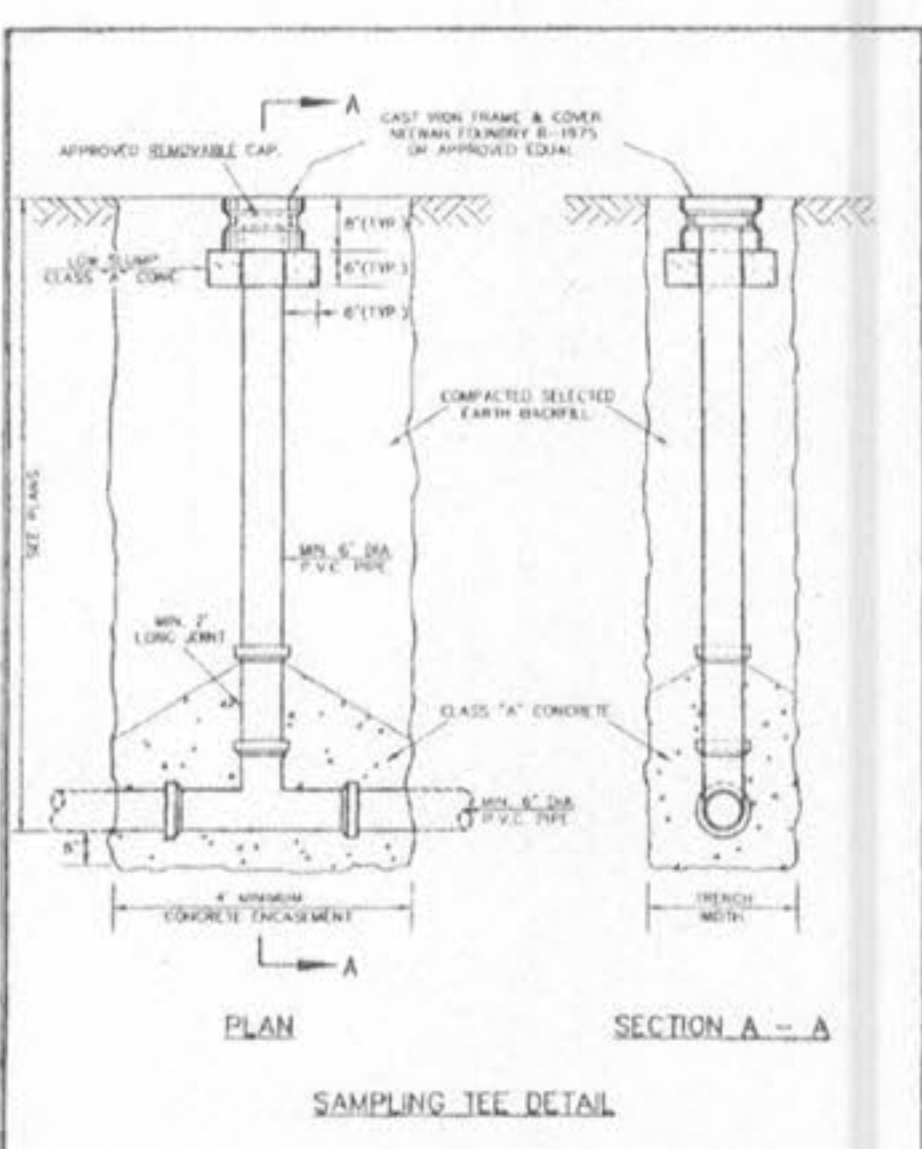

SAMPLING TEE
 METROPOLITAN ST. LOUIS SEWER DISTRICT
 Standard Details of Sewer Construction
 D. W. H. / J. C. K. 2000 SHEET 69



SIGNS
 METROPOLITAN ST. LOUIS SEWER DISTRICT
 Standard Details of Sewer Construction
 D. W. H. / J. C. K. 2000 SHEET 70

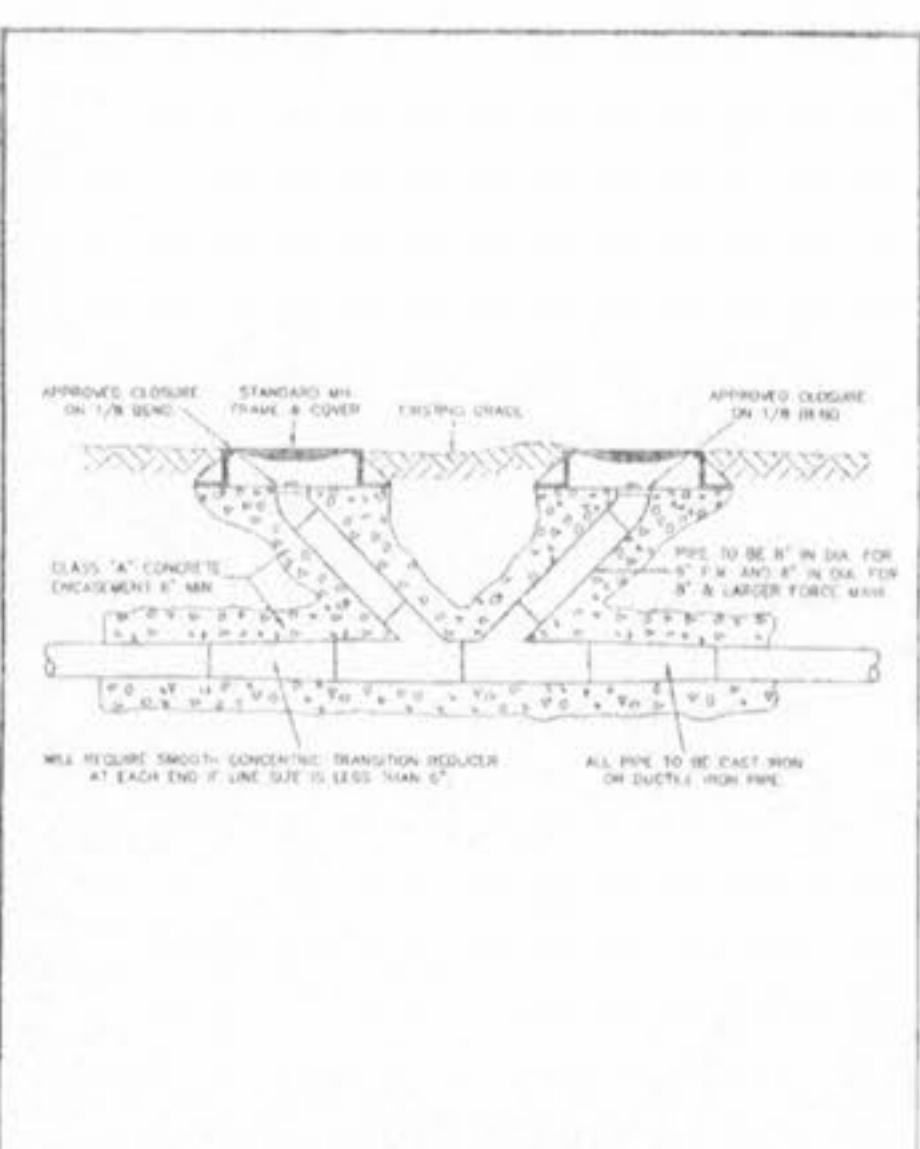

FORCE MAIN CLEANOUT (6" DIA. & SMALLER)
 METROPOLITAN ST. LOUIS SEWER DISTRICT
 Standard Details of Sewer Construction
 D. W. H. / J. C. K. 2000 SHEET 71

ISSUE	REMARKS/DATE
1	11-14-02 1st Submittal

PREPARED FOR:
McBride & Son Home, Inc.
 #1 McBride & Son Center Drive
 Chesterfield, Missouri 63005
 (636) 537-2000

THE **STERLING** CO.
 ENGINEERS & SURVEYORS
 5057 N. MISSOURI ROAD
 ST. LOUIS, MISSOURI 63128
 (314) 487-0440 FAX 487-8844
 E-Mail: Sterling@com-stl.net

DRAWN:	DESIGNED:	CHECKED:	DATE:
		RLA	
PROJECT:	CONSTRUCTION DETAILS		
SHEET TITLE:			
NO. 02	03	043	
M.S.D. P#	SHEET CD6		
DIGITAL FILE LOCATION	SEWER-STERLING-2		
DATE	OF		