

1 TREE PLANTING & STAKING DETAIL  
NOT TO SCALE

- NOTES:
1. SUPPORTING APPARATUS FOR TREE WILL BE REMOVED AFTER (1) COMPLETE GROWING SEASON. NOTE THAT FLEXIBLE ATTACHMENT WILL BE USED WHERE SUPPORT WIRES ARE WRAPPED AROUND TREE TRUNKS/STEMS TO PREVENT CAMBIAL DAMAGE.
  2. IT IS CONTRACTOR'S OPTION ON HOW TO STAKE TREES. HOWEVER, THE CONTRACTOR IS RESPONSIBLE FOR MAINTAINING TREES IN A PLUMB POSITION THROUGH-OUT THE GUARANTEE PERIOD.
  3. STAKE SHALL NOT PENETRATE PLANT BALL.

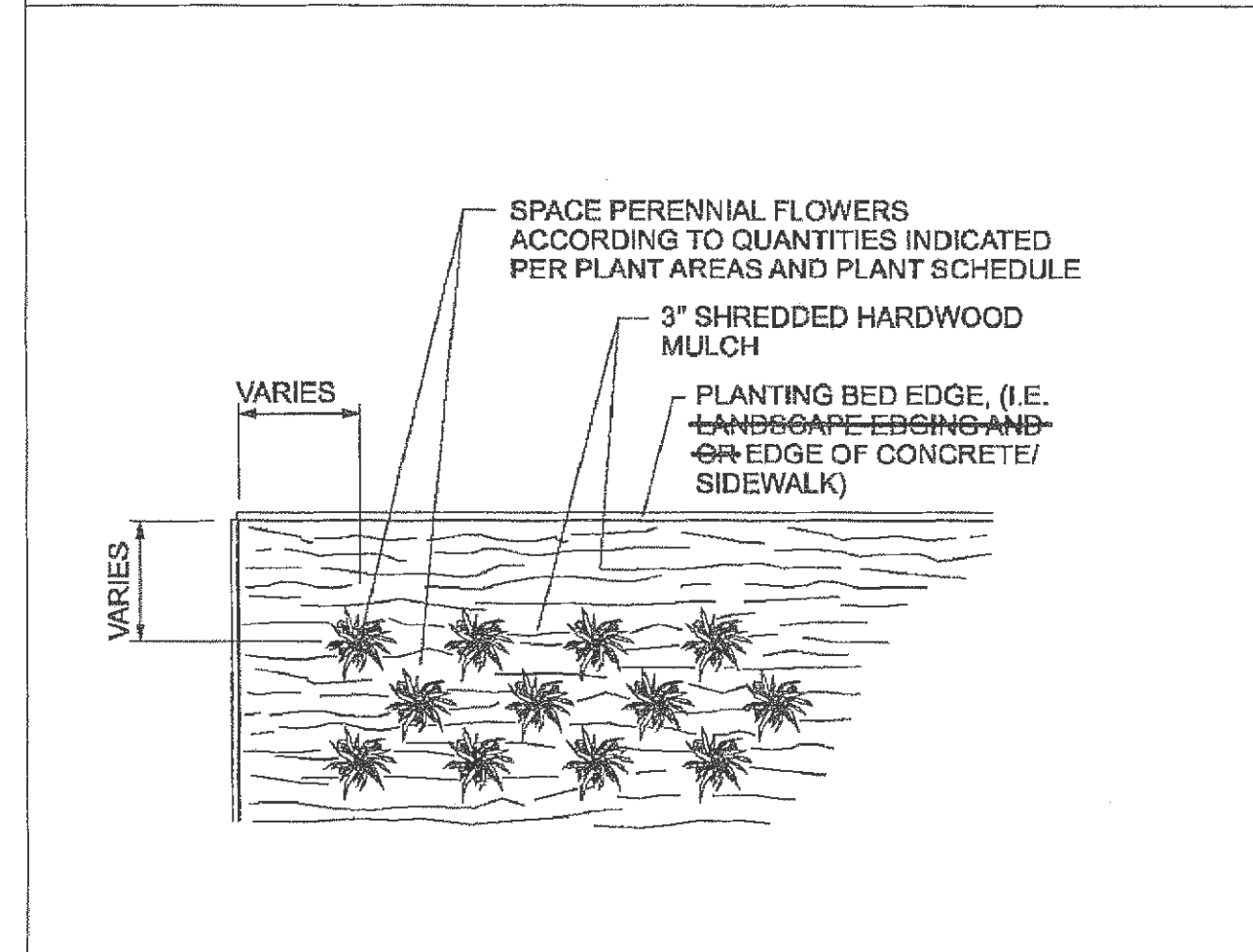

2 PERENNIAL FLOWER/GROUNDCOVER PLANTING DETAIL  
NOT TO SCALE

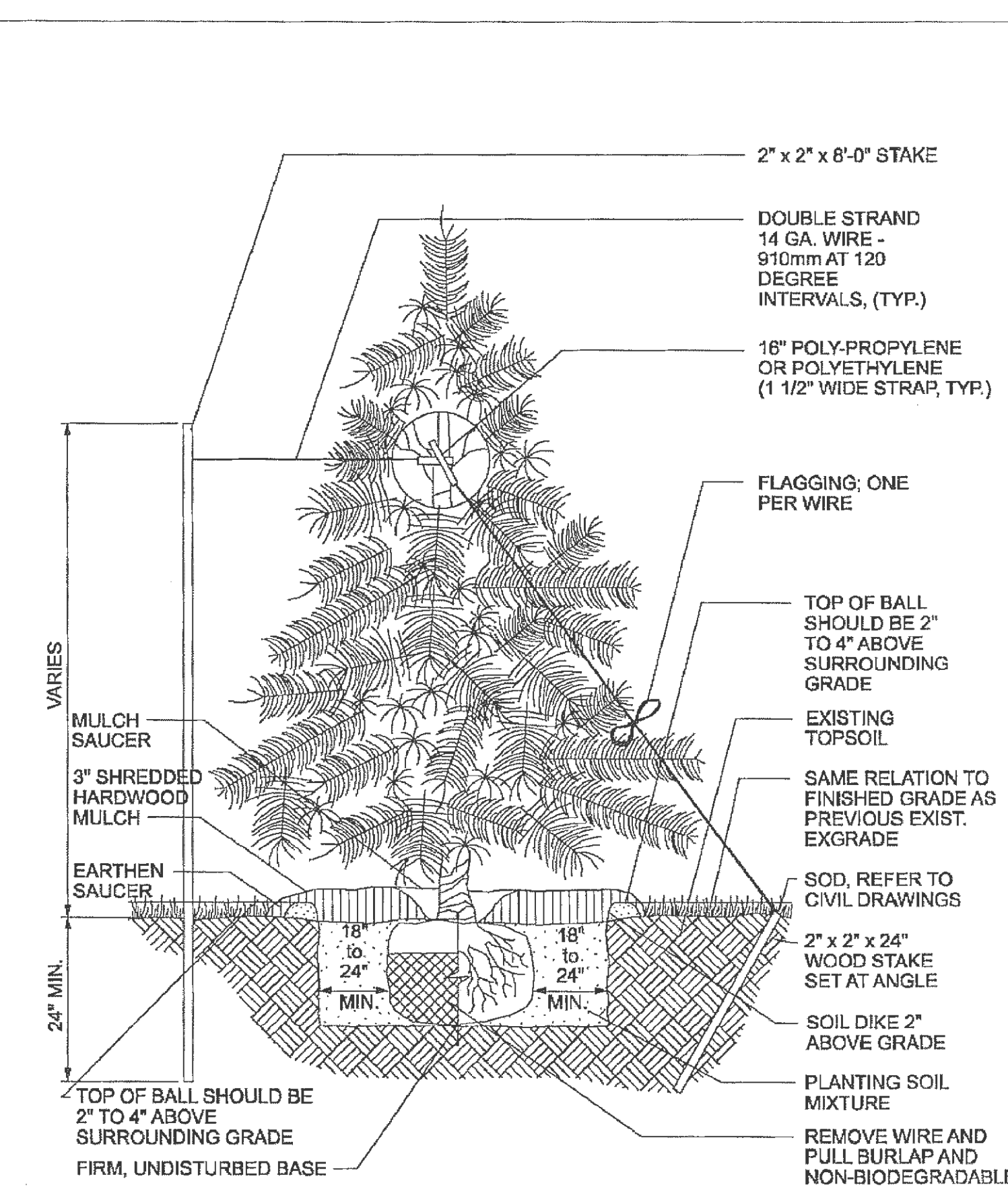

3 EVERGREEN PLANTING & STAKING DETAIL  
NOT TO SCALE

- NOTES:
1. CONIFER TO HAVE SHREDDED HARDWOOD MULCH UNLESS NOTED OTHERWISE. NO MULCH TO BE IN CONTACT WITH TRUNK.
  2. SCARIFY BOTTOM AND SIDES OF HOLE PRIOR TO PLANTING.

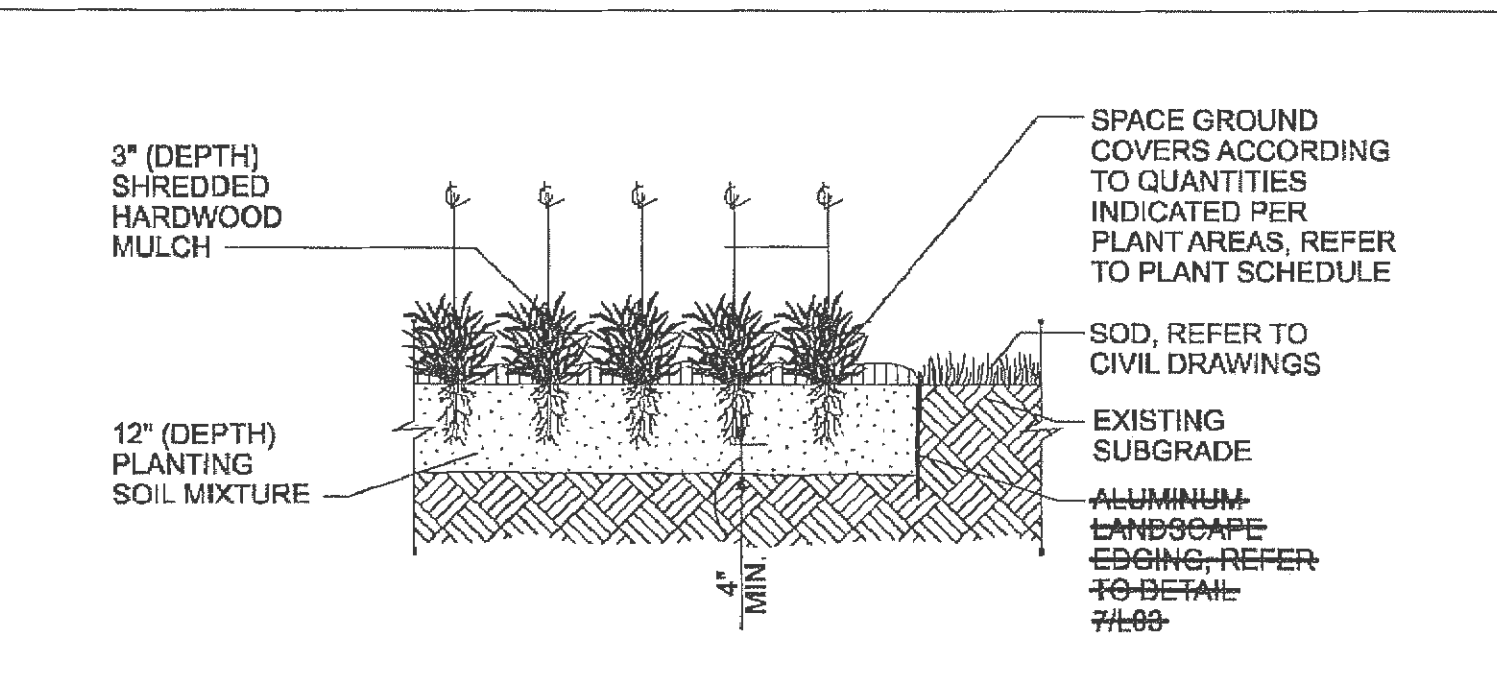

4 PERENNIAL FLOWER/GROUNDCOVER PLANTING DETAIL  
NOT TO SCALE

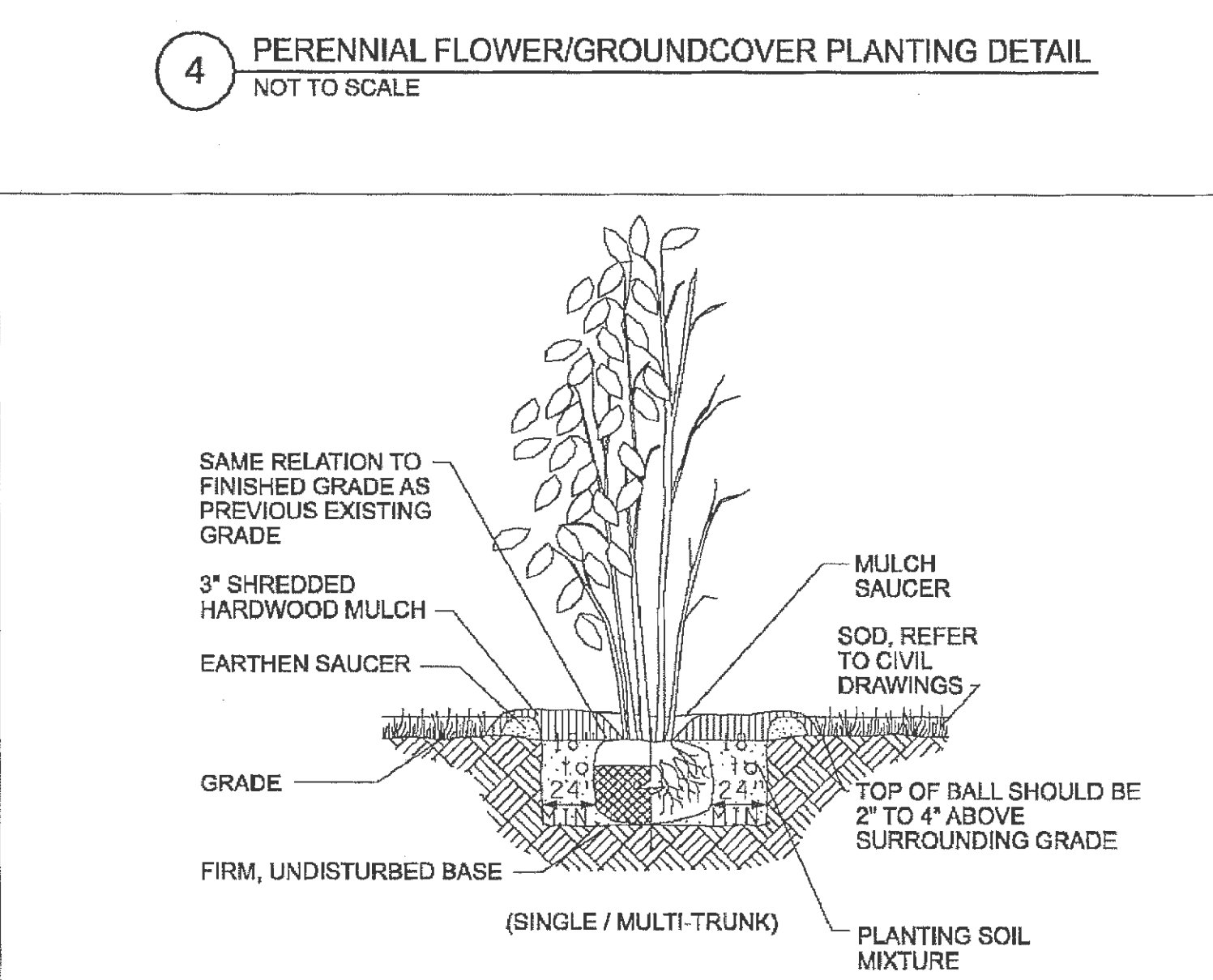

5 SMALL TREE/LARGE SHRUB PLANTING DETAIL  
NOT TO SCALE

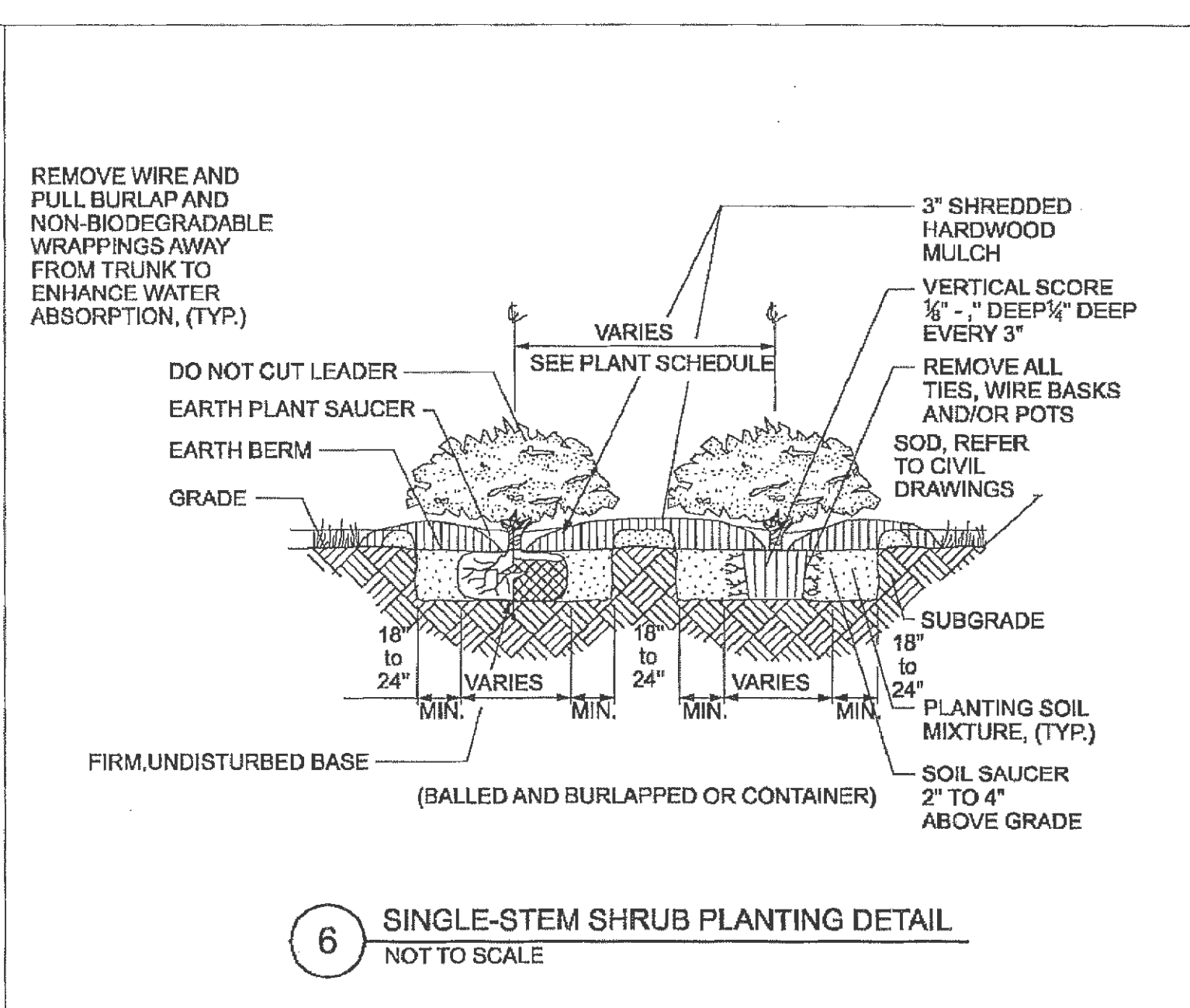

6 SINGLE-STEM SHRUB PLANTING DETAIL  
NOT TO SCALE

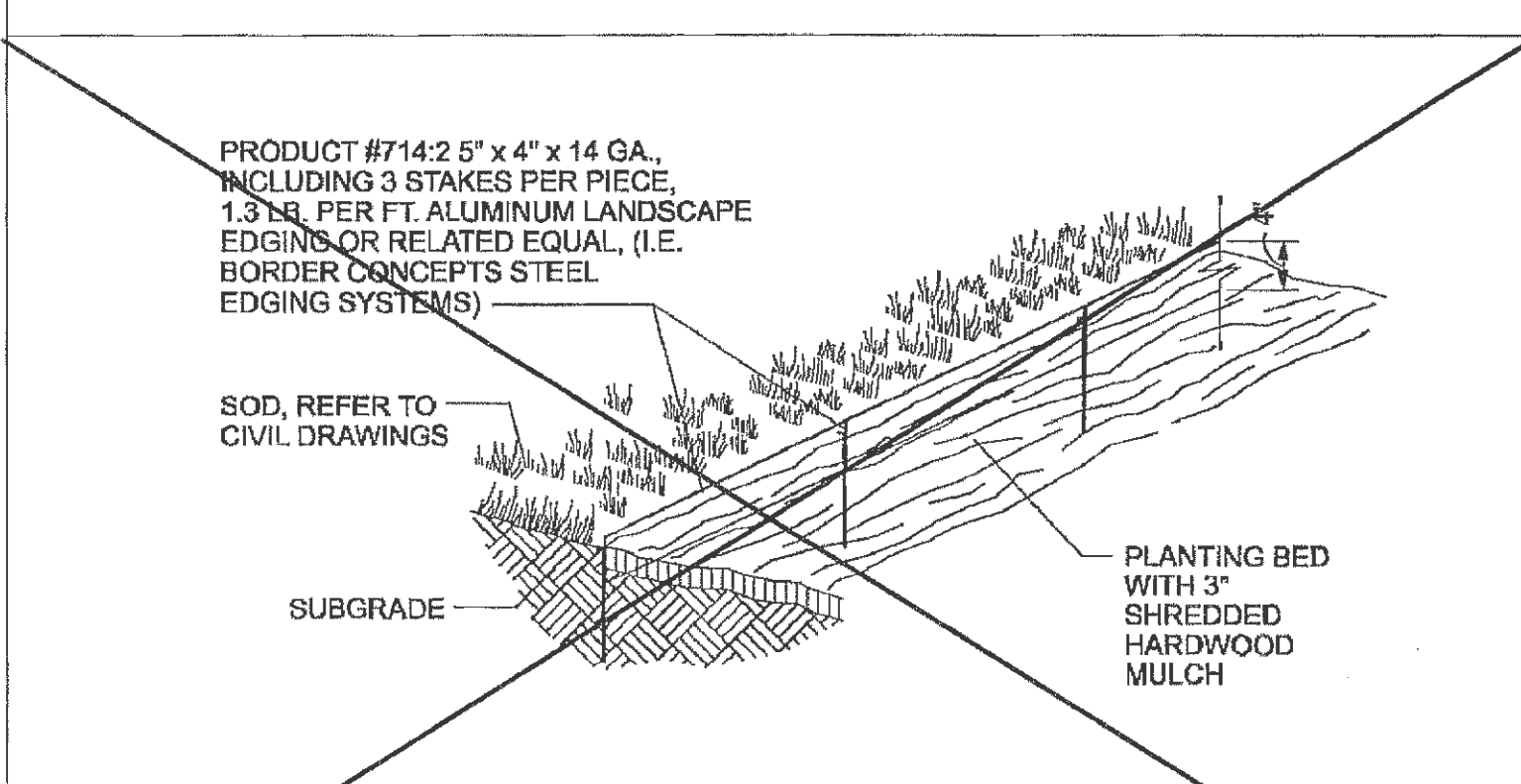

7 ALUMINUM AND/OR STEEL LANDSCAPE EDGING DETAIL  
NOT TO SCALE

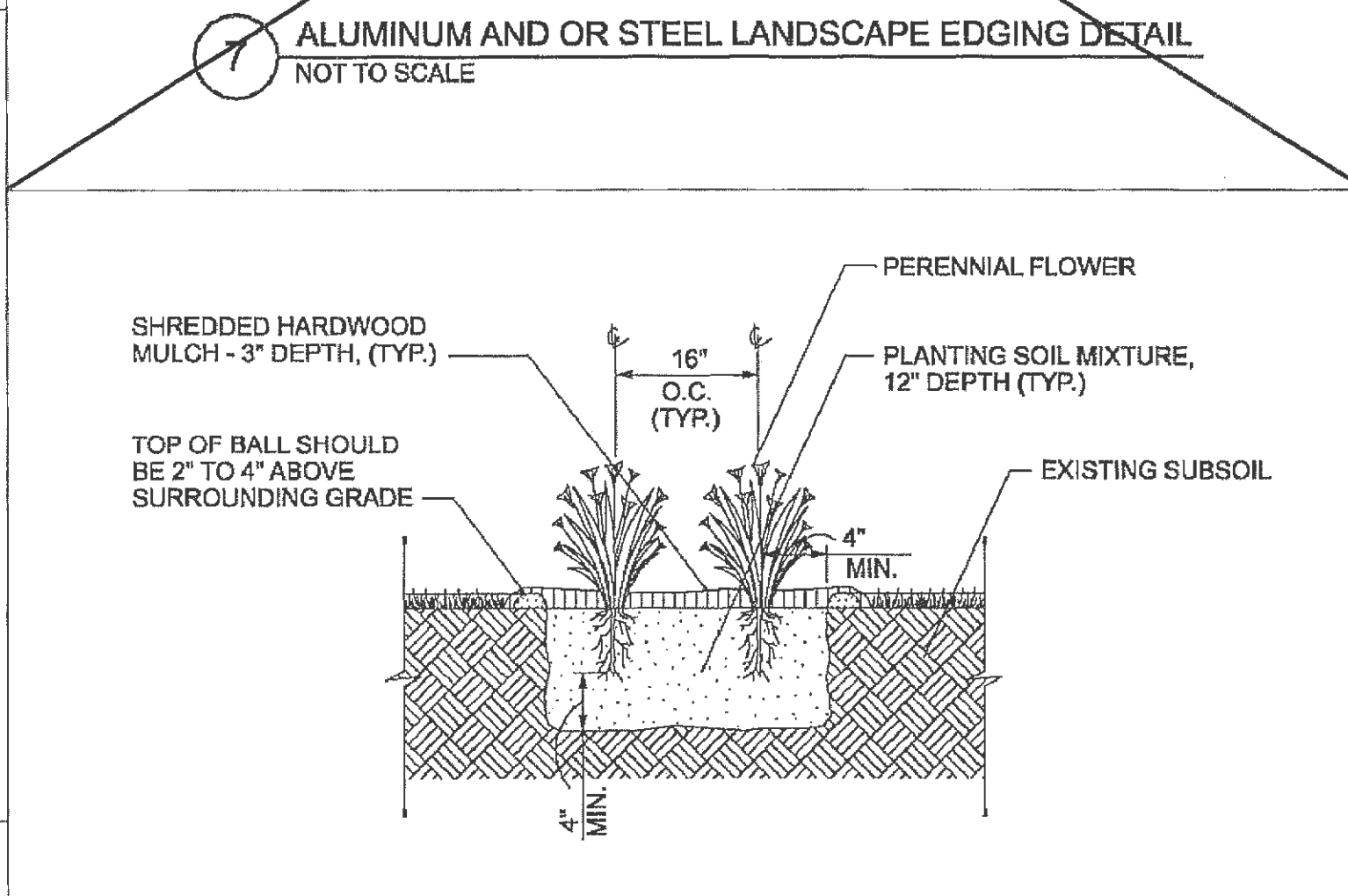

8 PERENNIAL FLOWER PLANTING DETAIL  
NOT TO SCALE

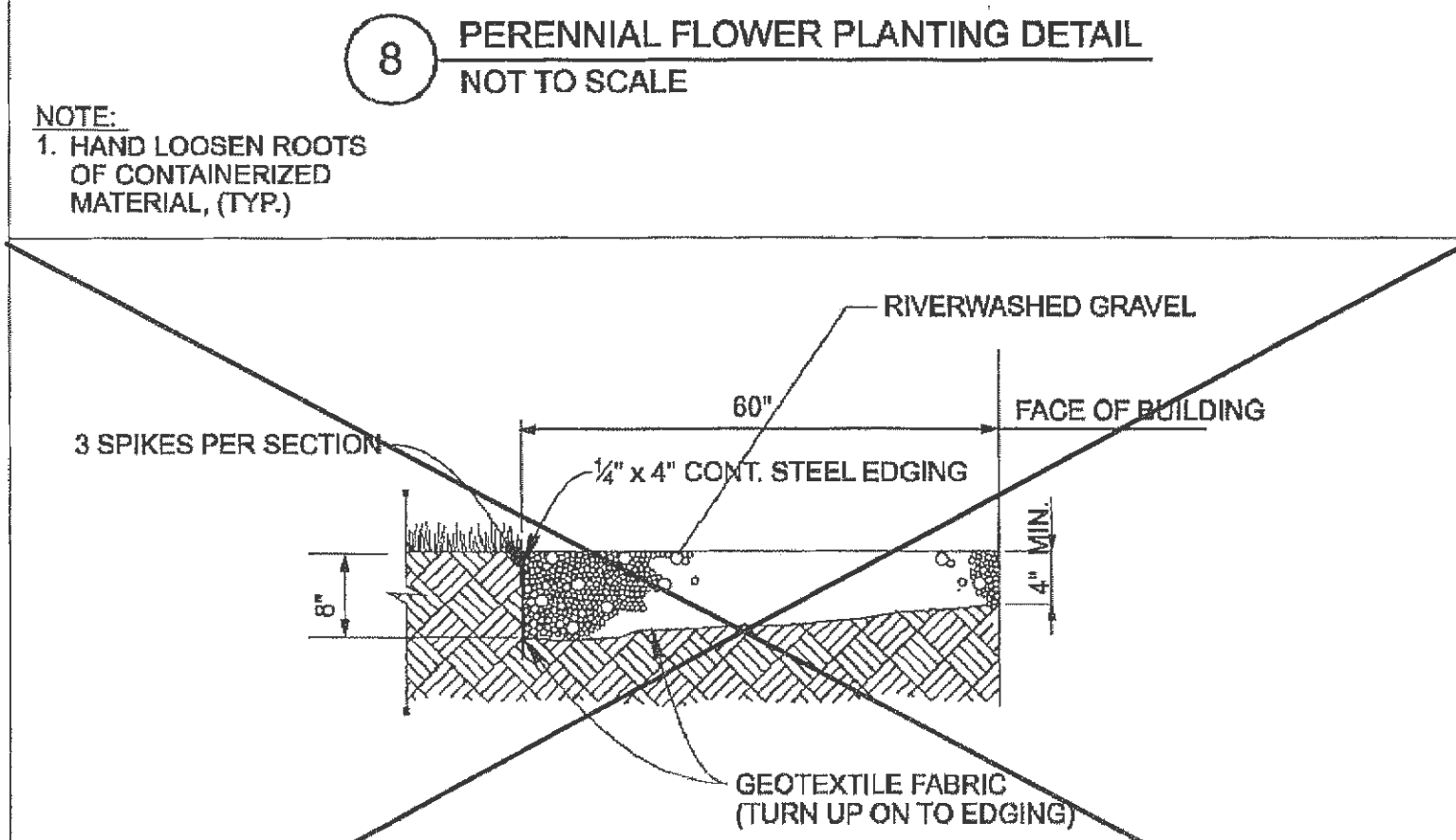

9 MOW STRIP DETAIL  
NOT TO SCALE

- SHEET NOTES:
1. ALL TOPSOIL SHALL BE RETAINED AND REUSED IN PLANTING HOLES AFTER DIGGING HAS BEEN COMPLETED. USE ANY EXCESS SOIL FROM THE PLANTING PIT AS WELL TO FORM A SAUCER 2\"/>
  - 2. MULCHING SHALL BE COMPLETED WITHIN 48 HOURS AFTER PLANTING OF NEW PLANT MATERIAL. MULCH SHALL BE SPREAD TO A DEPTH OF 3\"/>
  - 3. ALL PLANTS SHALL BE "WATERED IN" BY FLOODING THE BACKFILLED HOLE WITHIN THE SAME WORKING DAY UPON WHICH THEY WERE PLANTED. DURING AND IMMEDIATELY AFTER WATERING, ALL PLANTS SHALL BE ADJUSTED AS NECESSARY TO INSURE CORRECT DEPTH OF PLANTING, VERTICAL ALIGNMENT AND/OR TO COMPENSATE FOR SETTLING. SOIL SHALL BE FIRMED AROUND EACH PLANT AS FINAL ADJUSTMENTS ARE MADE.
  - 4. PLANTS SHALL BE SET PLUMB AND HELD IN POSITION UNTIL SUFFICIENT SOIL HAS BEEN FIRMLY PLACED AROUND THE ROOTS OR BALL. PLANTS SHALL BE SET AT GROUND LEVEL OR NO MORE THAN 2\"/>
  - 5. CLEAR, REMOVE AND DISPOSE OF BRUSH, SNAGS, AND RUBBISH WITHIN 60\"/>
  - 6. PLANT ALL NEW PLANT MATERIAL AT ORIGINAL FIELD GROWN LEVEL. TAMP SOIL MIX BELOW ROOT BALL.
  - 7. PLANTING HOLES ASSOCIATED WITH PROPOSED TREES SHOULD BE SLOPED (NOT COMPACTED) AND A MINIMUM OF 18-24 INCHES WIDER THAN THE DIAMETER OF THE ROOT BALL. TREES WILL BE INSTALLED SUCH THAT THE TOP OF THE ROOT MASS IS LEVEL WITH THE SURFACE OF THE PLANTING HOLE. TREES SHALL ALSO BE INSTALLED 3-5 INCHES ABOVE GRADE ON SITES CONTAINING CLAY.

PREMIERDRIVE (Isener) CIVIL 3D PROJECTS\090404\CONSTRUCTION PLANS\090404\LANDSCAPE DETAIL.dwg 7/16/2014 4:27 PM



NOTE  
Underground utilities and structures have been plotted from available information and therefore, their location must be considered approximate only. It is the responsibility of the individual contractors to notify the utility companies before actual construction.

**CVS pharmacy**

NORTHERN 13,225-LEFT  
CHAMFER DRIVE-THRU  
STORE NUMBER: 10194  
SVC. VETERANS MEMORIAL PARKWAY & HWY. K  
ST. LOUIS, MO  
PROJECT TYPE: NEW CONSTRUCTION  
DEAL TYPE: Fee for Service/Land/Type B  
CS PROJECT NUMBER: 52332

**NORR**

ARCHITECTS ENGINEERS PLANNERS  
719 Grinstead Street  
Suite 1000  
Des Moines, IA 50326  
(515) 264-0113

**PREMIER CIVIL ENGINEERING**

308 TOW Court  
Lake Saint Louis, MO 63367  
Phone: (314) 925-7444 Fax: (314) 925-7457  
Missouri Certificate of Authority # E-2011000031  
Missouri Certificate of Authority # LS-2012007849

STEVE MARLON P.E.  
ENGINEER  
PE200007849

Developer / Owner Information

T.M.  
**CROWLEY & ASSOCIATES**

Landscaping Details

P+Z No. 20-13  
APPROVED 9-5-13  
City No.

Sheet Number:  
**LS-2**  
PCE PROJECT NO. 094201