

2 GRATE INLET
 METROPOLITAN ST. LOUIS SEWER DISTRICT
Standard Details of Sewer Construction
 Dr. R.P.P. June 1984 Sheet 34
 Ch. J.H.S.

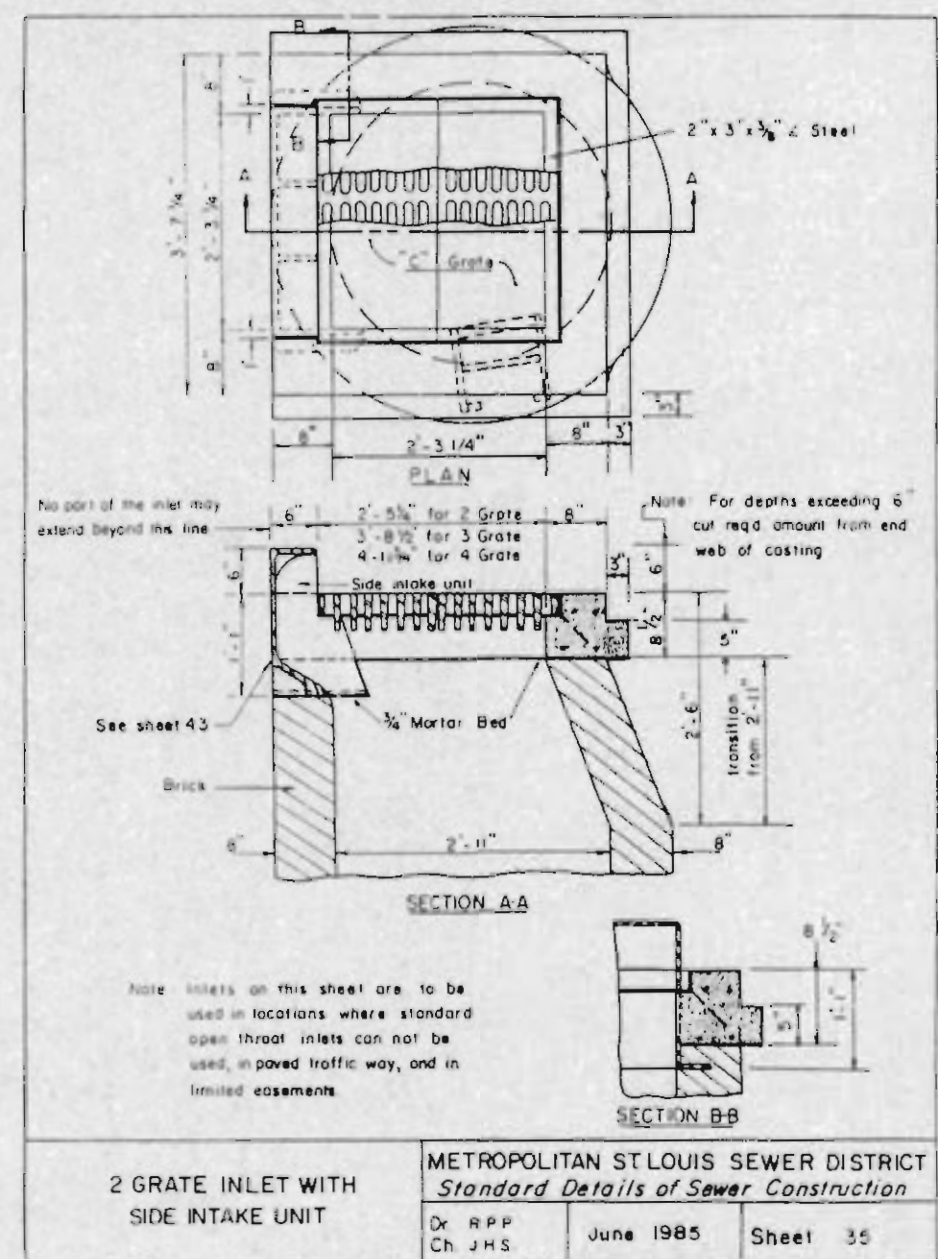

2 GRATE INLET WITH SIDE INTAKE UNIT
 METROPOLITAN ST. LOUIS SEWER DISTRICT
Standard Details of Sewer Construction
 Dr. R.P.P. June 1985 Sheet 35
 Ch. J.H.S.

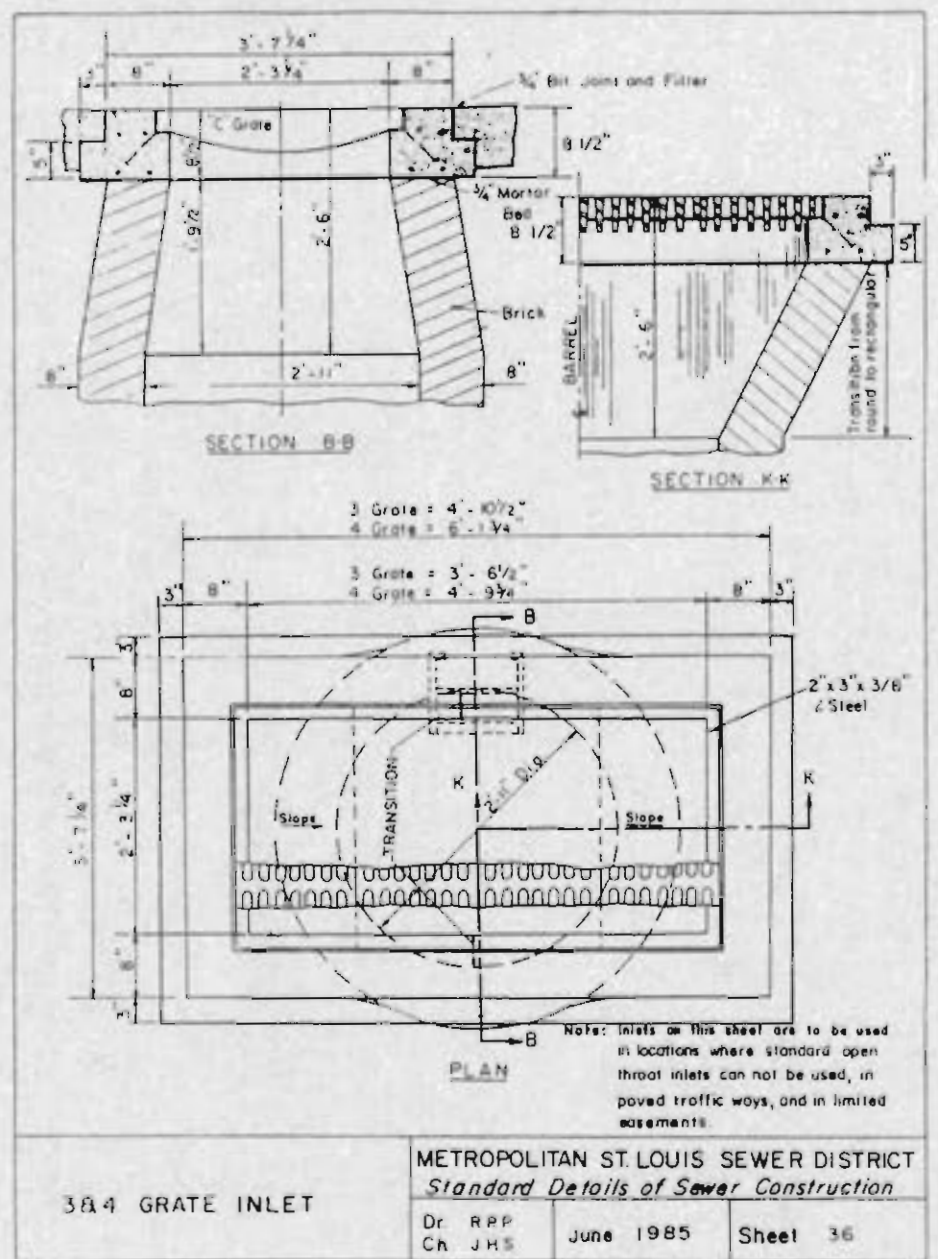

3B.4 GRATE INLET
 METROPOLITAN ST. LOUIS SEWER DISTRICT
Standard Details of Sewer Construction
 Dr. R.P.P. June 1985 Sheet 36
 Ch. J.H.S.

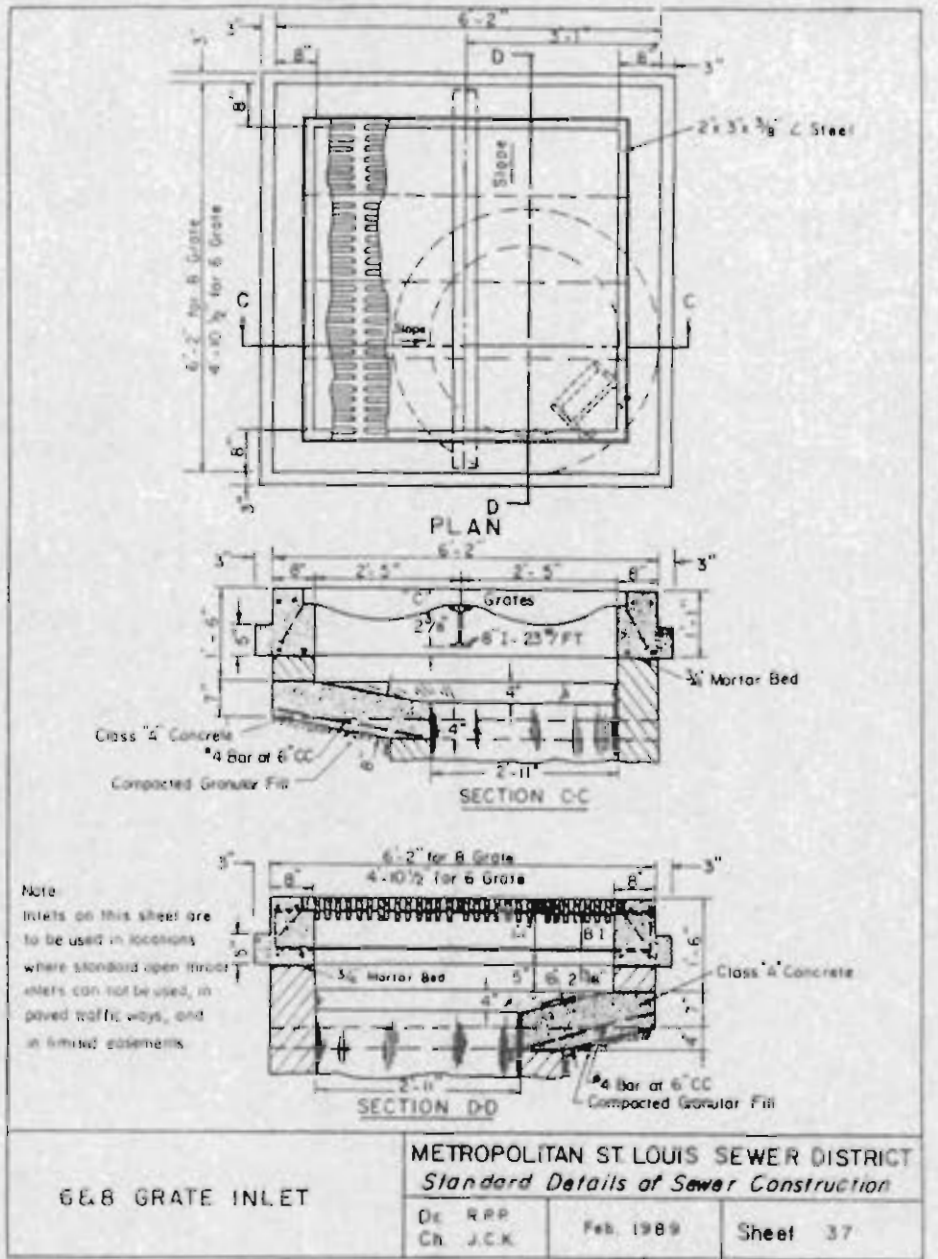

6.6.B GRATE INLET
 METROPOLITAN ST. LOUIS SEWER DISTRICT
Standard Details of Sewer Construction
 Dr. R.P.P. Feb. 1989 Sheet 37
 Ch. J.C.K.

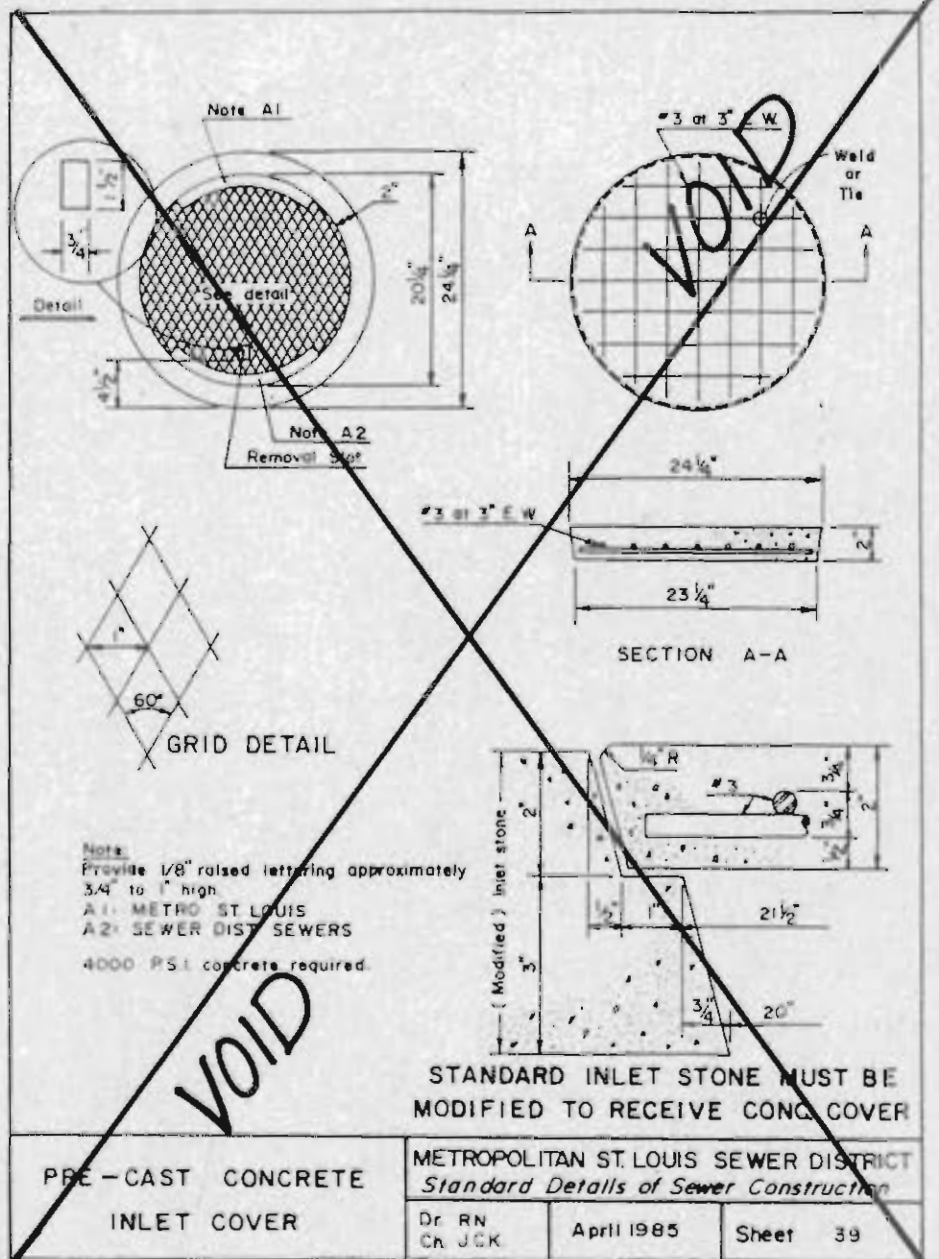

PRE-CAST CONCRETE INLET COVER
 METROPOLITAN ST. LOUIS SEWER DISTRICT
Standard Details of Sewer Construction
 Dr. R.N. April 1985 Sheet 39
 Ch. J.C.K.

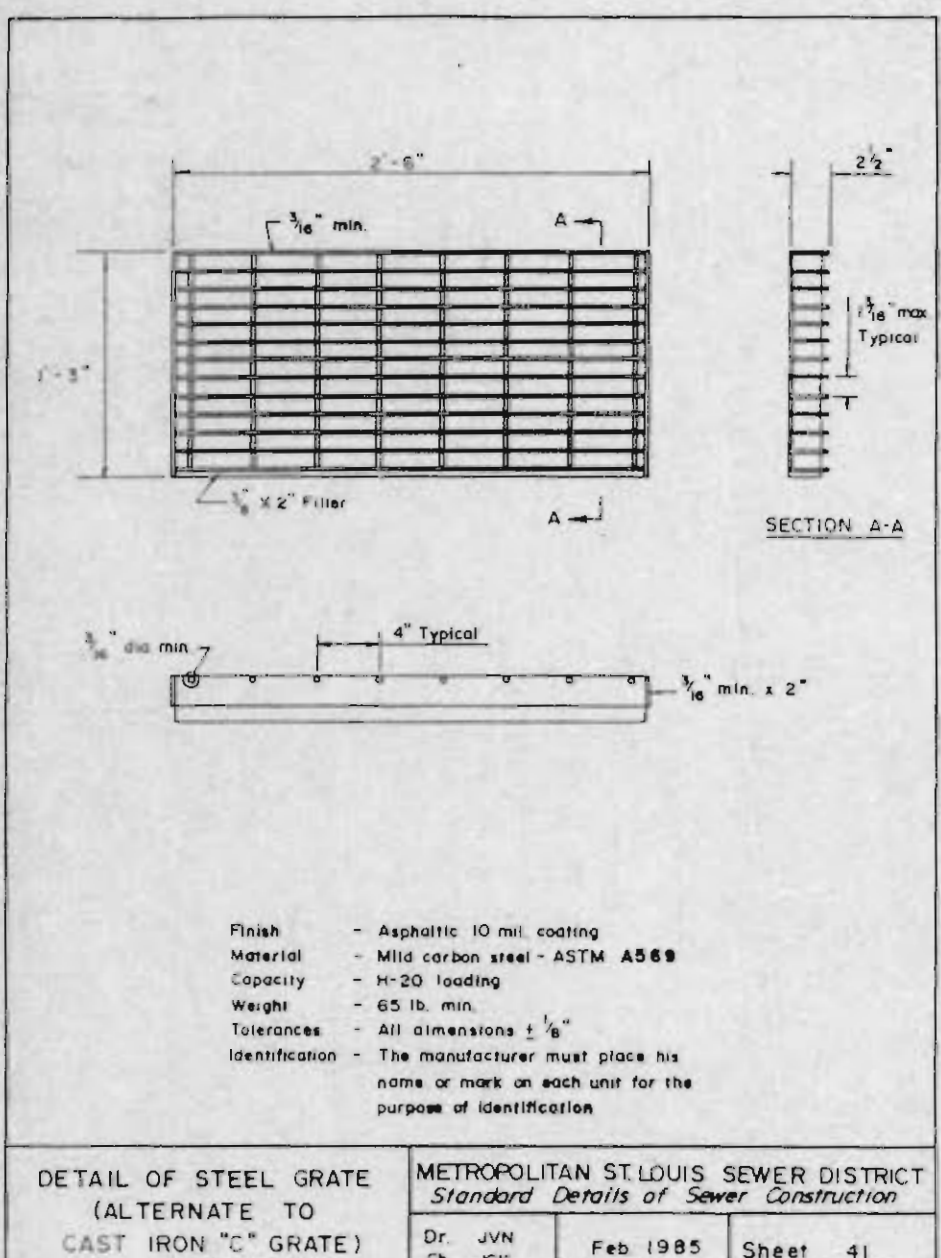
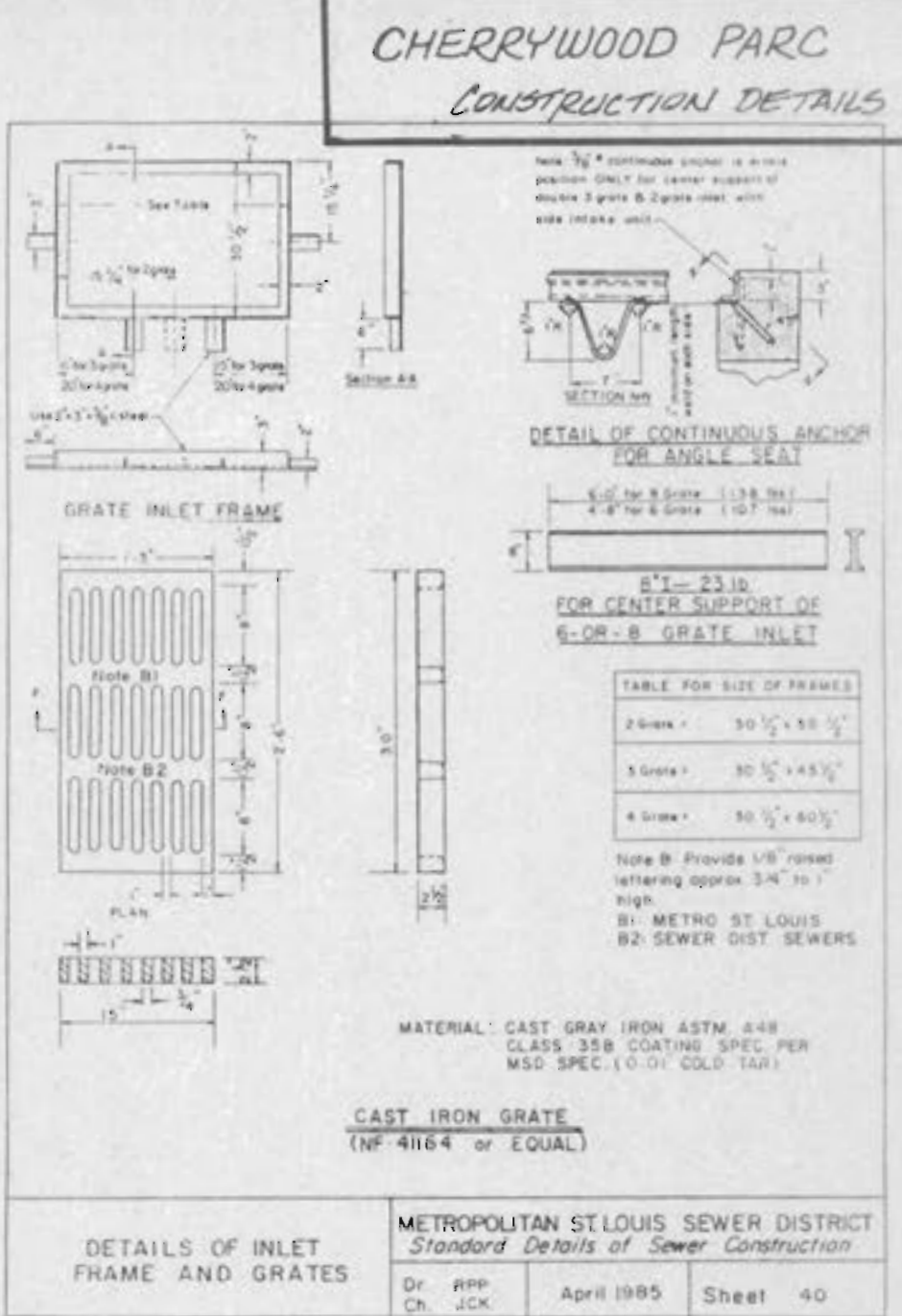

DETAILED STEEL GRATE (ALTERNATE TO CAST IRON "C" GRATE)
 METROPOLITAN ST. LOUIS SEWER DISTRICT
Standard Details of Sewer Construction
 Dr. J.V.N. Feb. 1985 Sheet 41
 Ch. J.C.K.

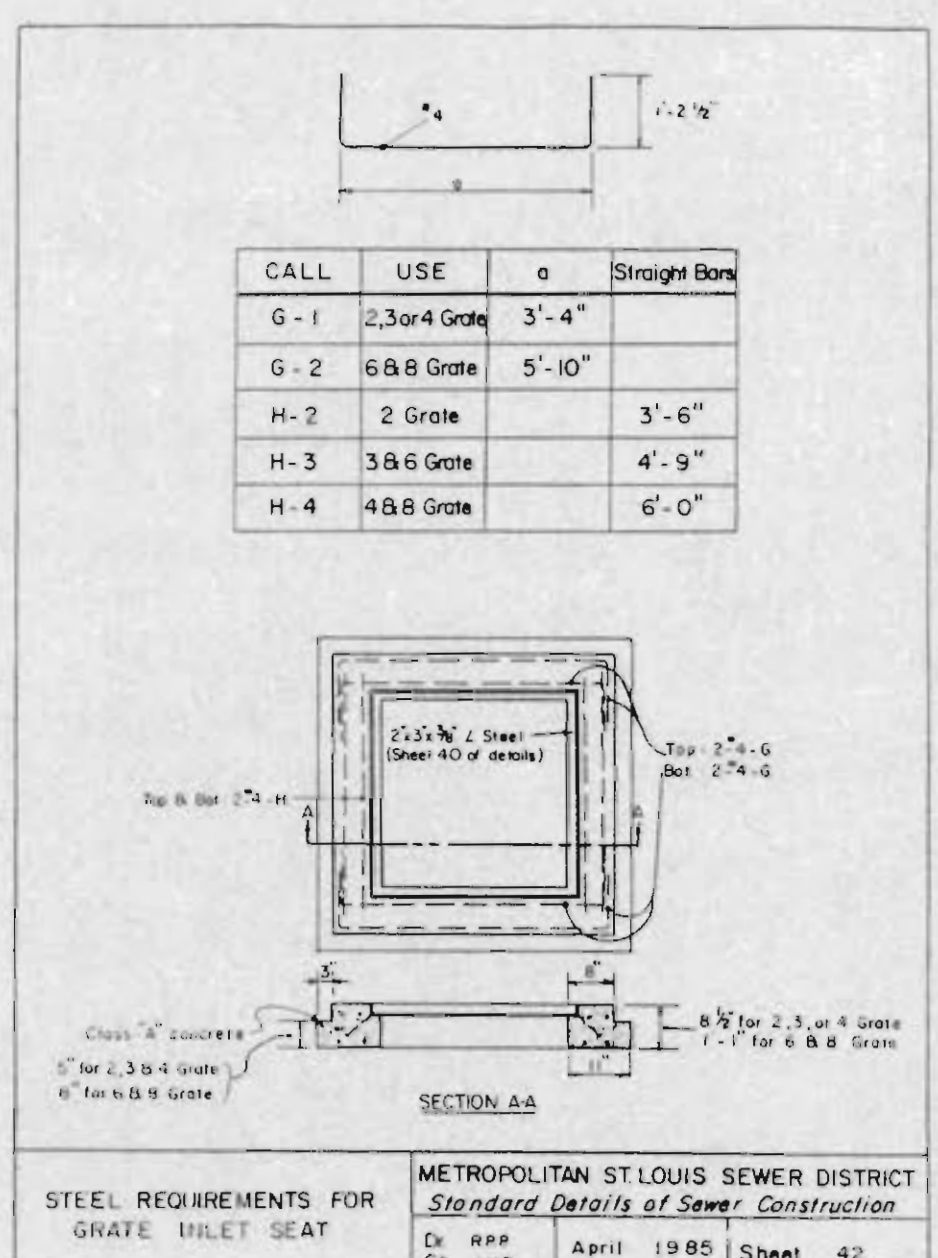

STEEL REQUIREMENTS FOR GRATE INLET SEAT
 METROPOLITAN ST. LOUIS SEWER DISTRICT
Standard Details of Sewer Construction
 Dr. R.P.P. April 1985 Sheet 42
 Ch. J.H.S.

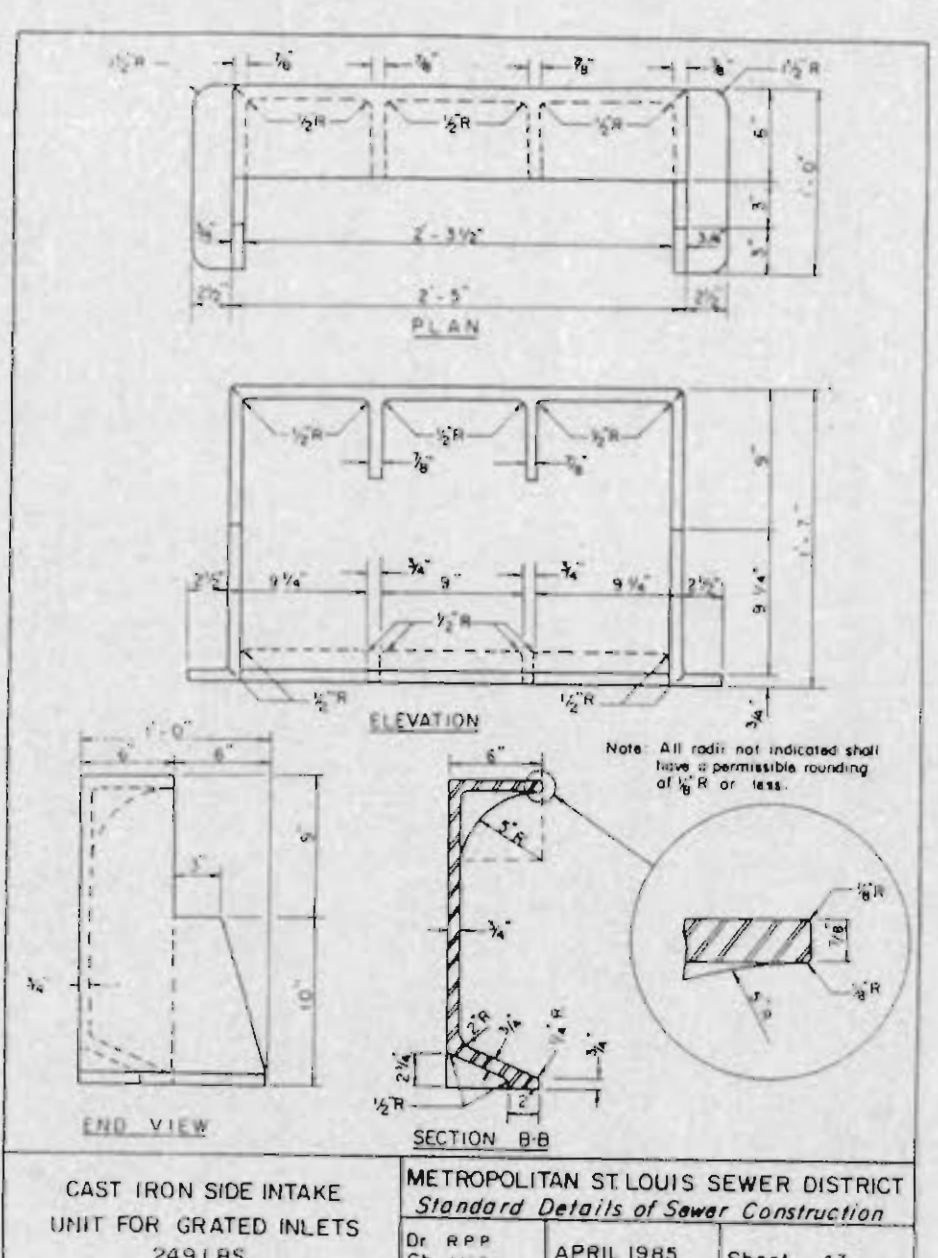

CAST IRON SIDE INTAKE UNIT FOR GRATED INLETS 249 LBS.
 METROPOLITAN ST. LOUIS SEWER DISTRICT
Standard Details of Sewer Construction
 Dr. R.P.P. April 1985 Sheet 43
 Ch. J.H.S.

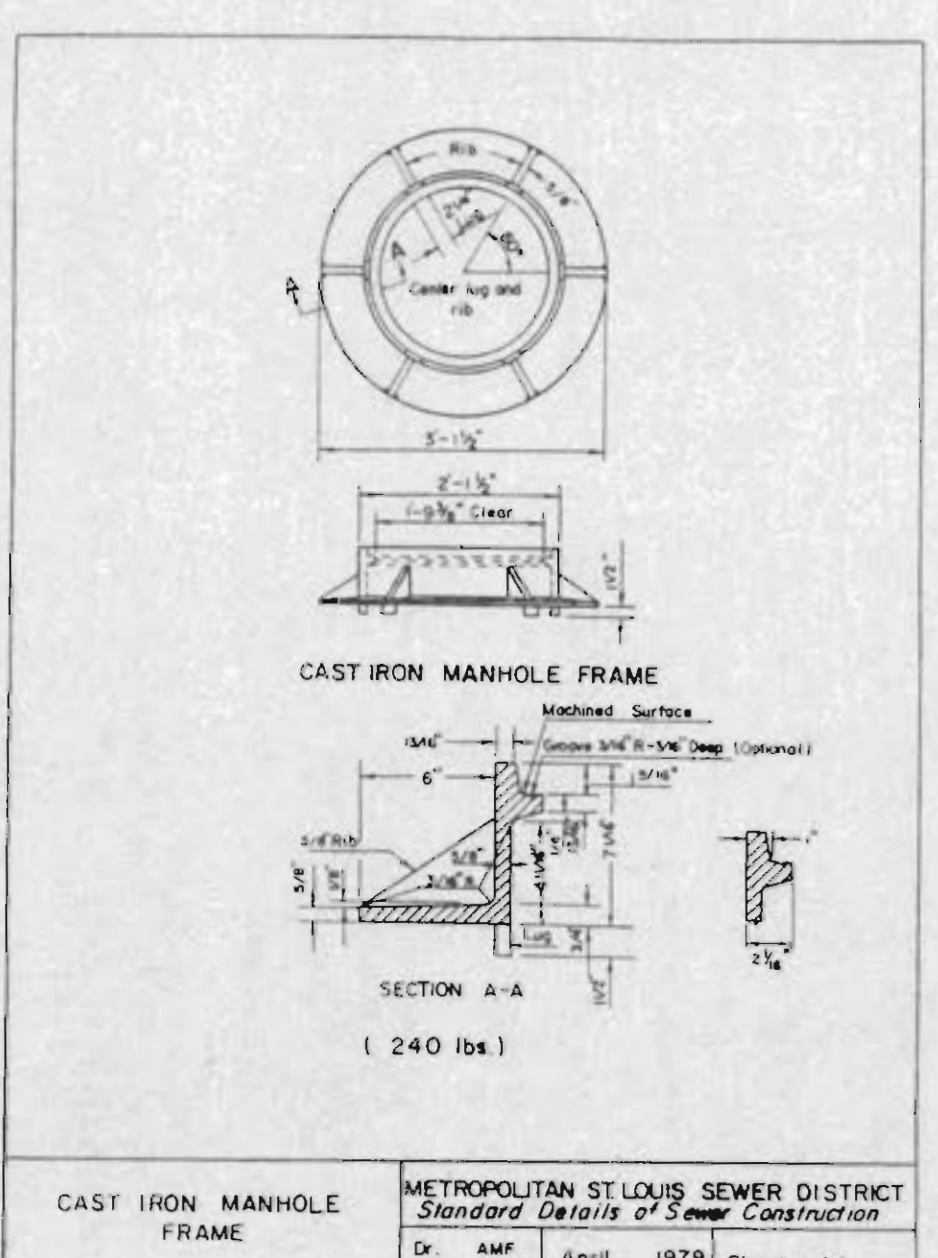

CAST IRON MANHOLE FRAME
 METROPOLITAN ST. LOUIS SEWER DISTRICT
Standard Details of Sewer Construction
 Dr. A.M.F. April 1979 Sheet 44
 Ch. J.C.K.

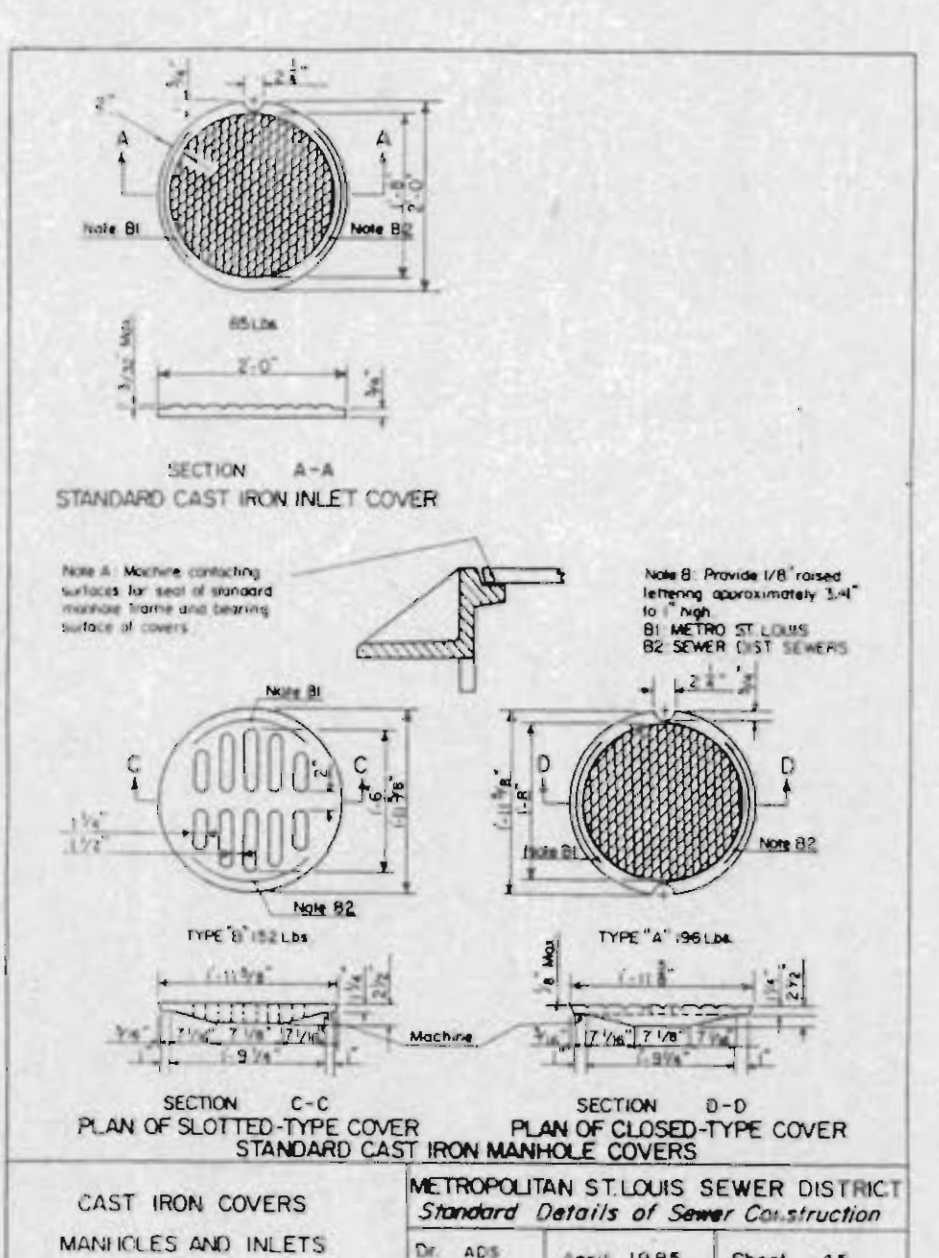

CAST IRON COVERS MANHOLE AND INLETS
 METROPOLITAN ST. LOUIS SEWER DISTRICT
Standard Details of Sewer Construction
 Dr. A.D.S. April 1985 Sheet 45
 Ch. J.H.S.

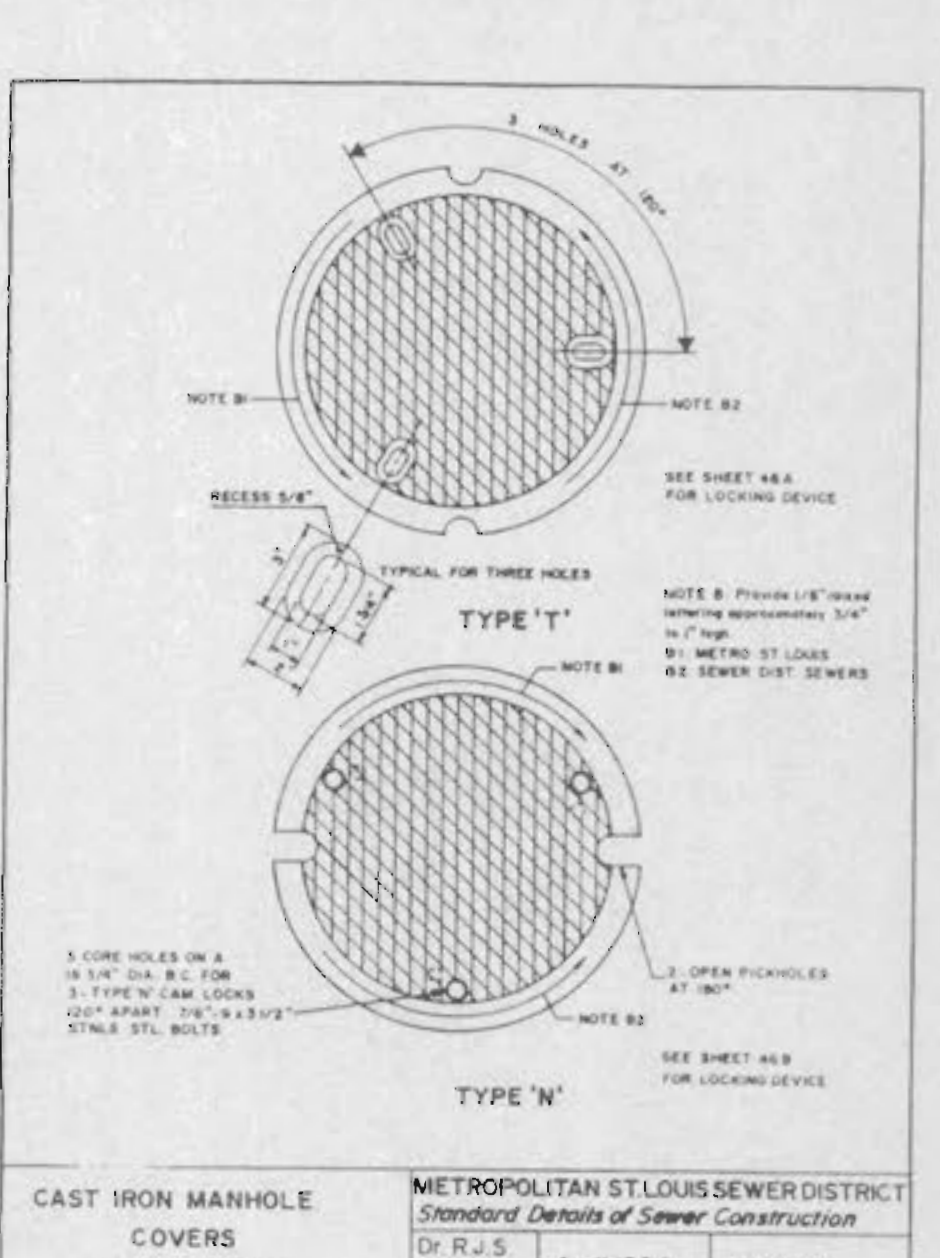

CAST IRON MANHOLE COVERS (LOCK TYPE)
 METROPOLITAN ST. LOUIS SEWER DISTRICT
Standard Details of Sewer Construction
 Dr. R.J.S. April 1984 Sheet 46
 Ch. J.C.K.

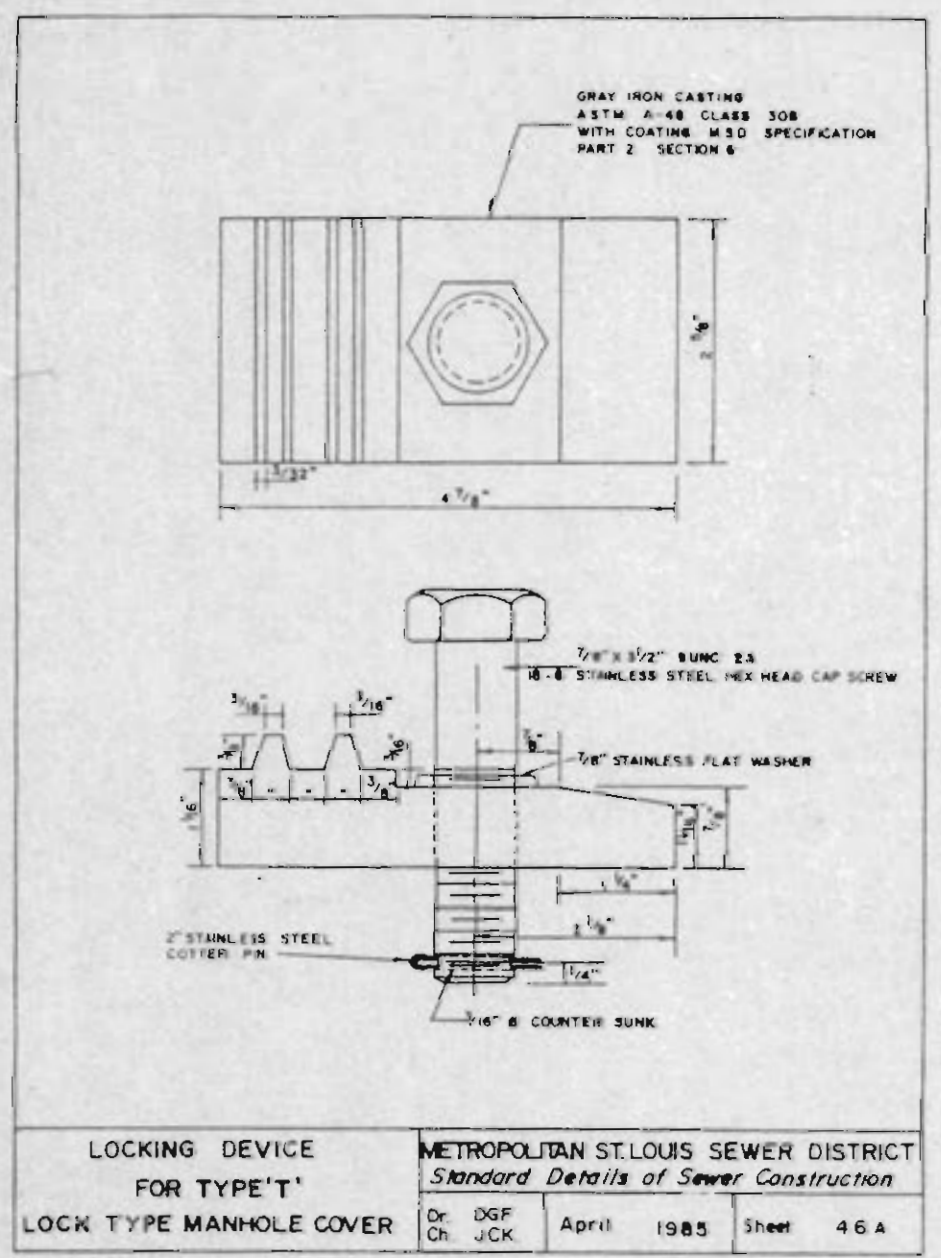

LOCKING DEVICE FOR TYPE 'T' LOCK TYPE MANHOLE COVER
 METROPOLITAN ST. LOUIS SEWER DISTRICT
Standard Details of Sewer Construction
 Dr. D.G.F. April 1985 Sheet 46 A
 Ch. J.C.K.

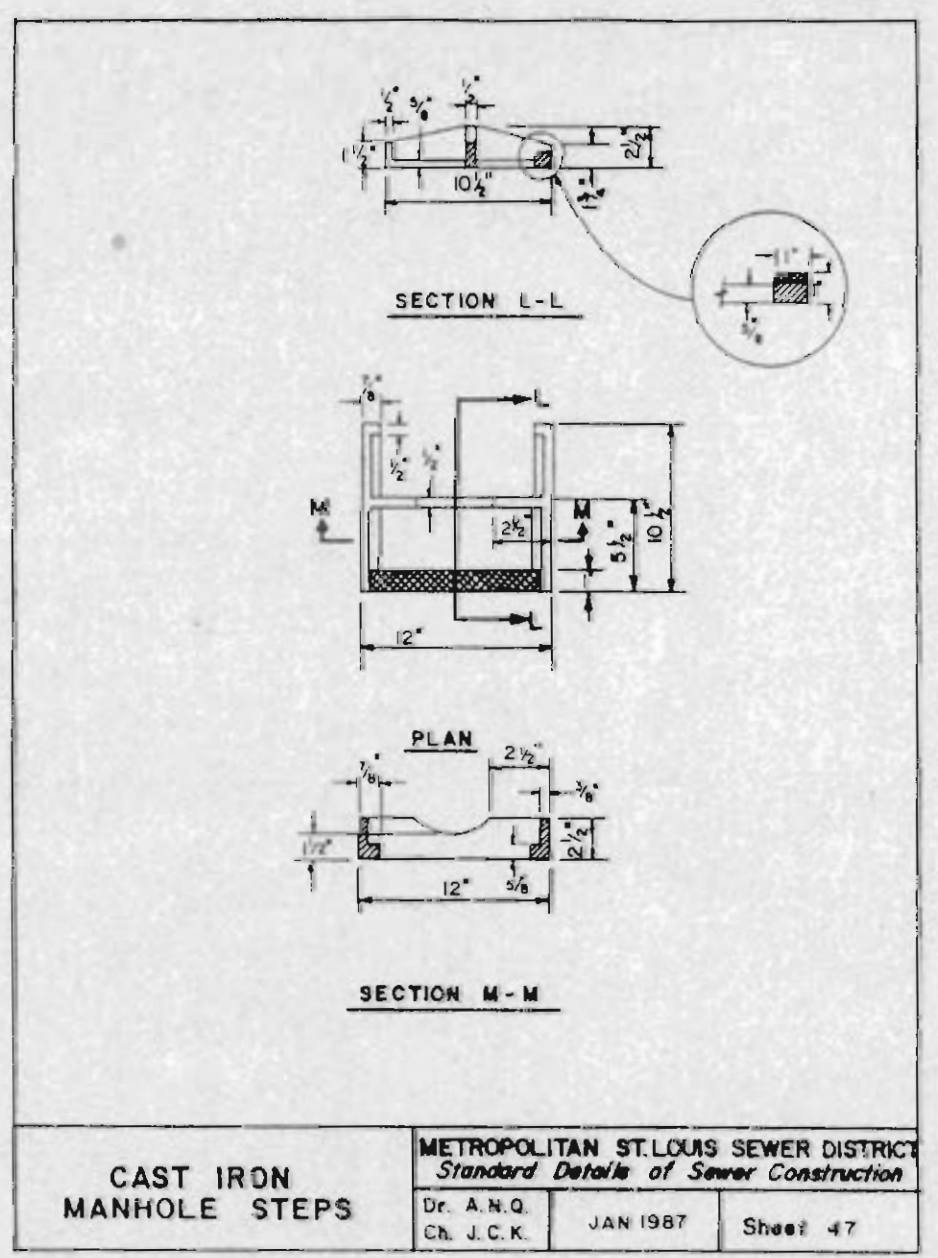

CAST IRON MANHOLE STEPS
 METROPOLITAN ST. LOUIS SEWER DISTRICT
Standard Details of Sewer Construction
 Dr. A.N.G. Jan 1987 Sheet 47
 Ch. J.C.K.

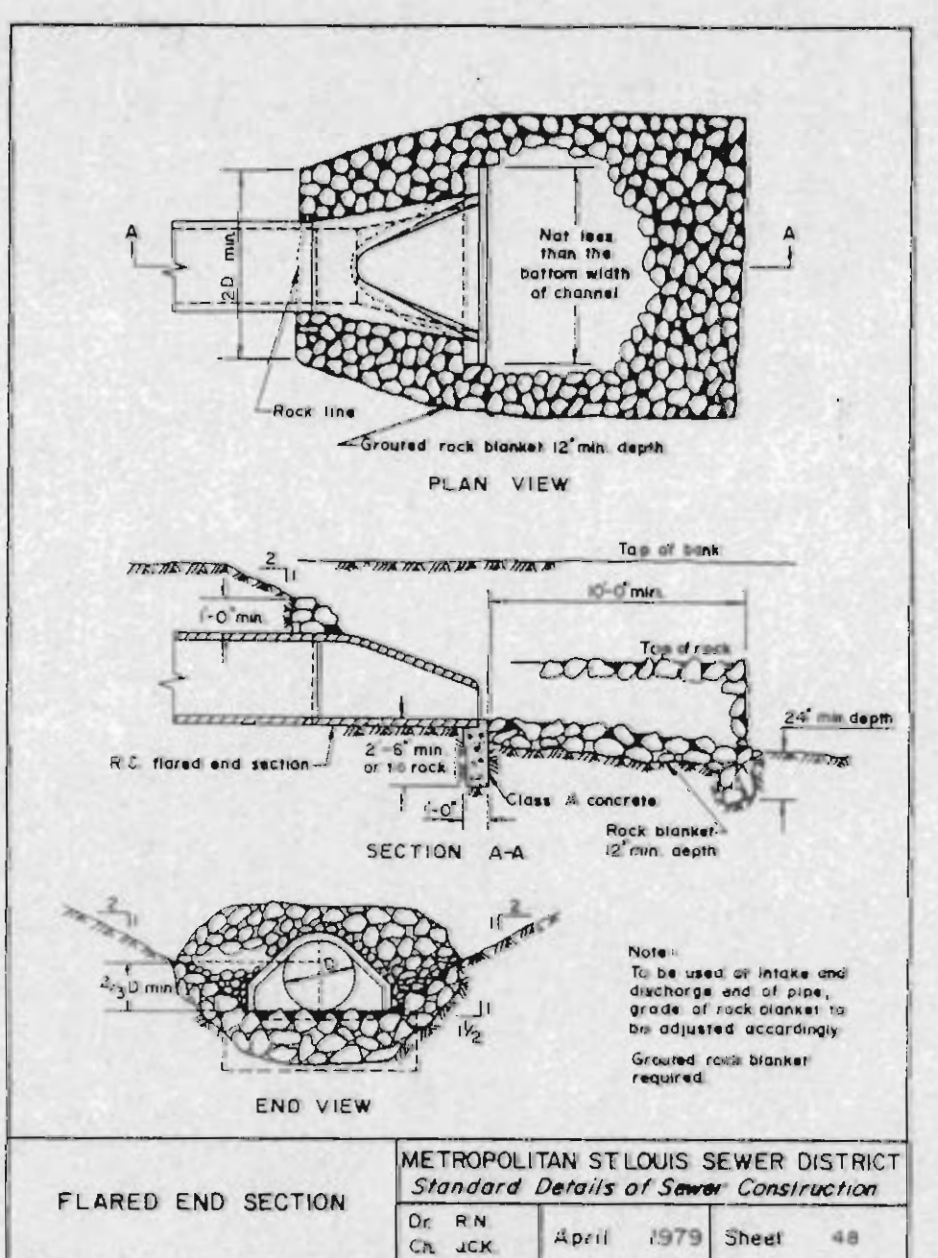

FLARED END SECTION
 METROPOLITAN ST. LOUIS SEWER DISTRICT
Standard Details of Sewer Construction
 Dr. R.N. April 1979 Sheet 48
 Ch. J.C.K.

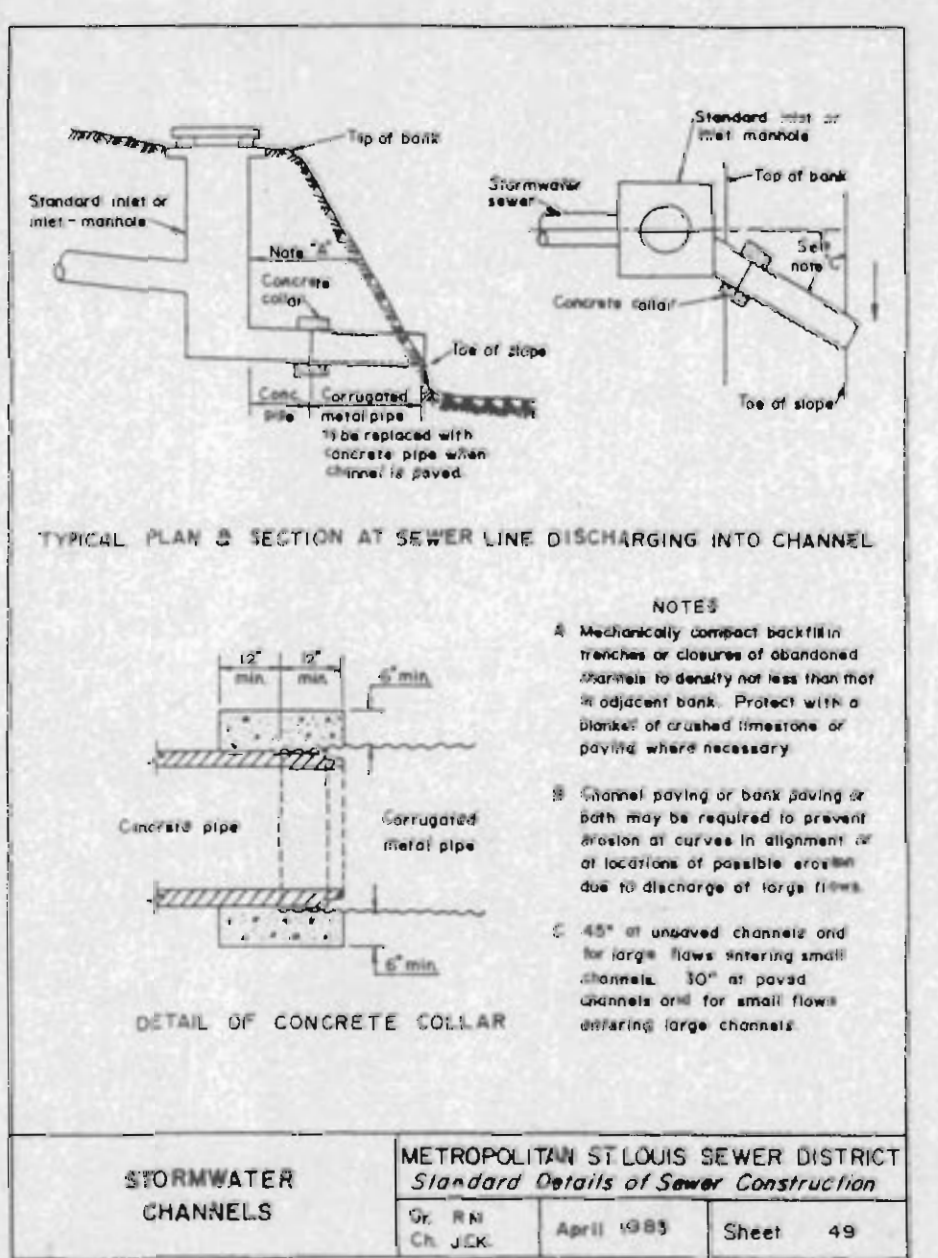

STORMWATER CHANNELS
 METROPOLITAN ST. LOUIS SEWER DISTRICT
Standard Details of Sewer Construction
 Dr. R.N. April 1985 Sheet 49
 Ch. J.C.K.

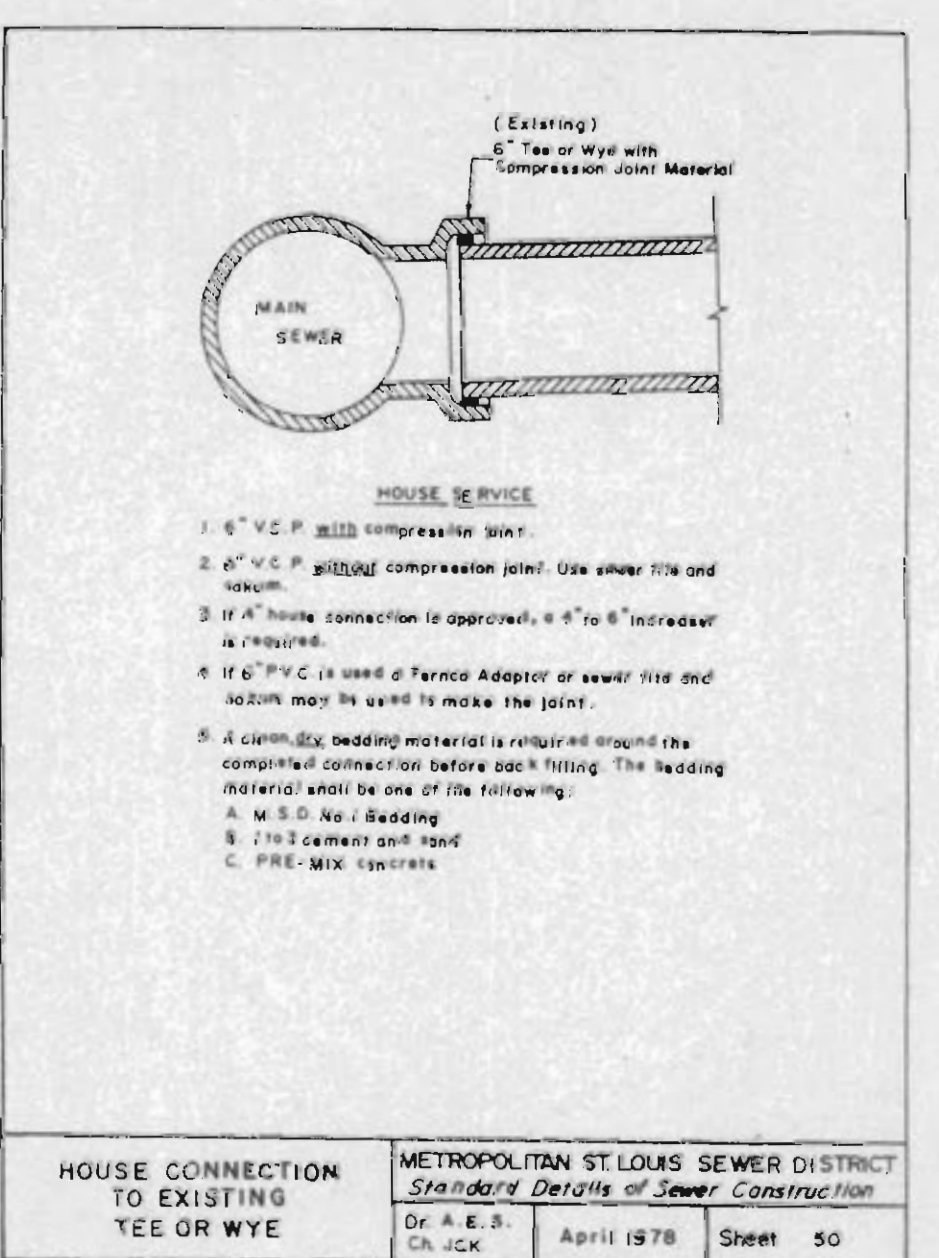

HOUSE CONNECTION TO EXISTING TEE OR WYE
 METROPOLITAN ST. LOUIS SEWER DISTRICT
Standard Details of Sewer Construction
 Dr. A.E.S. April 1978 Sheet 50
 Ch. J.C.K.

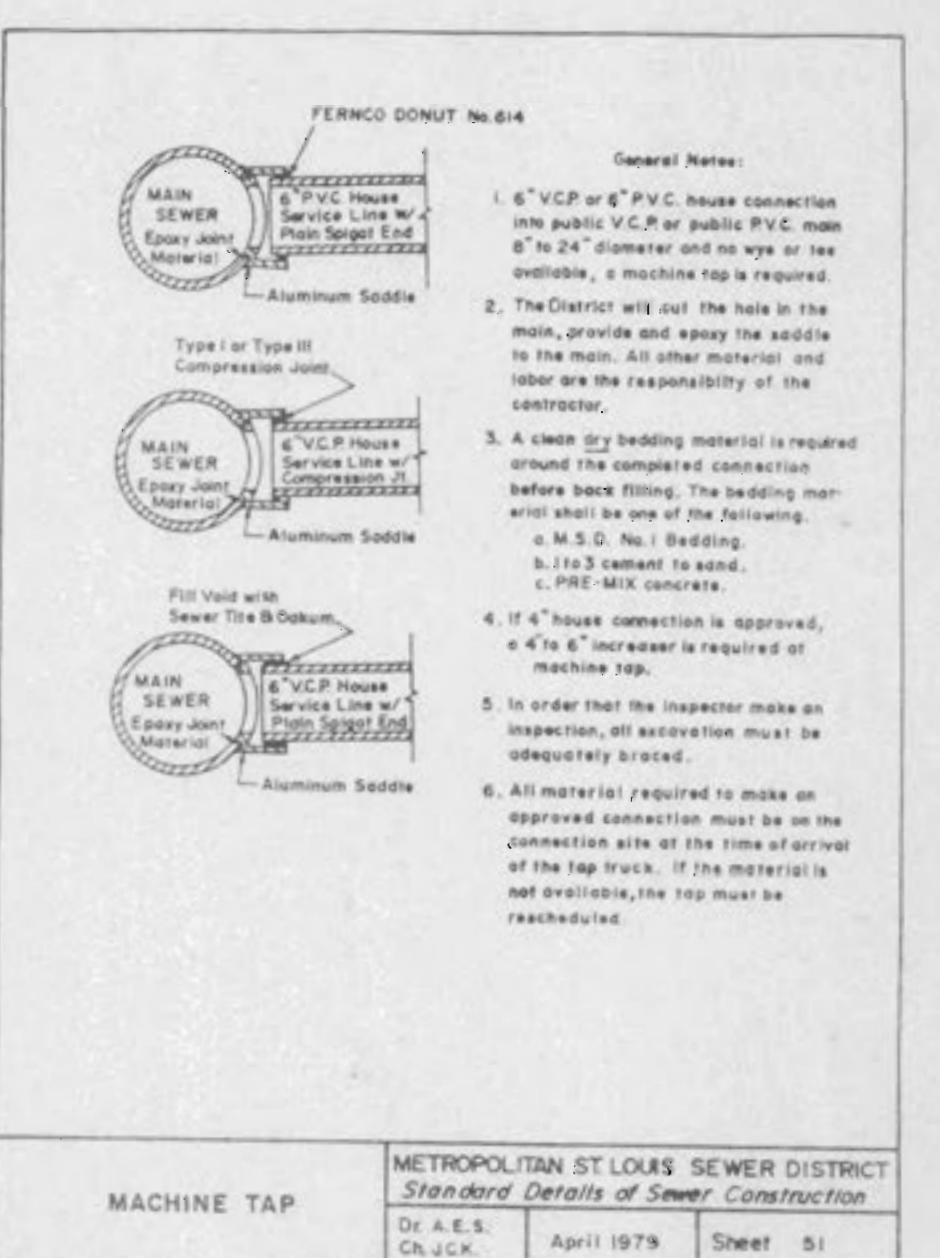

MACHINE TAP
 METROPOLITAN ST. LOUIS SEWER DISTRICT
Standard Details of Sewer Construction
 Dr. A.E.S. April 1978 Sheet 51
 Ch. J.C.K.