

REVISIONS:
 12-10-07 Per City Comments
 12-11-07 Addendum B
 12-14-07 Addendum D
 1-18-08 Revision 1
 2-11-08 Revision 2/City Comments
 2-21-08 Revision 3

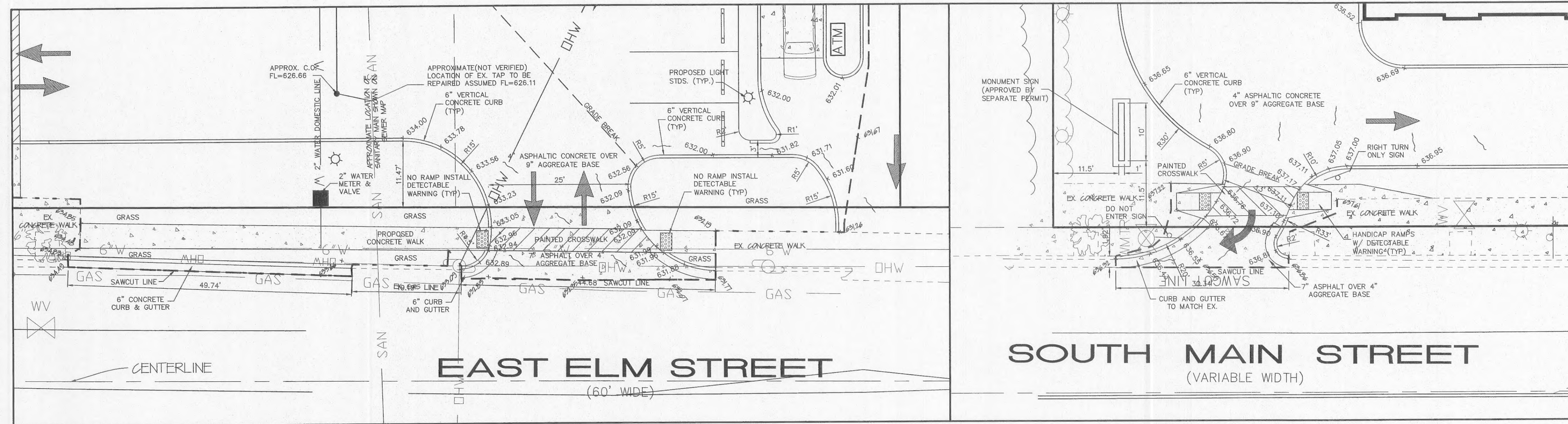

SOUTH ENTRANCE DETAIL
 SCALE: 1"=10'

NOTE: ALL SPOTS ARE TO TOP OF PAVEMENT UNLESS OTHERWISE NOTED.
 NOTE: EXISTING PAVEMENT REMOVAL IS TO BE TO THE NEAREST JOINT.
 NOTE: SIDEWALK TO BE REPAIRED AS NEEDED.

WEST ENTRANCE DETAIL
 SCALE: 1"=10'

NOTE: ALL SPOTS ARE TO TOP OF PAVEMENT UNLESS OTHERWISE NOTED.
 NOTE: EXISTING PAVEMENT REMOVAL IS TO BE TO THE NEAREST JOINT.
 NOTE: SIDEWALK TO BE REPAIRED AS NEEDED.

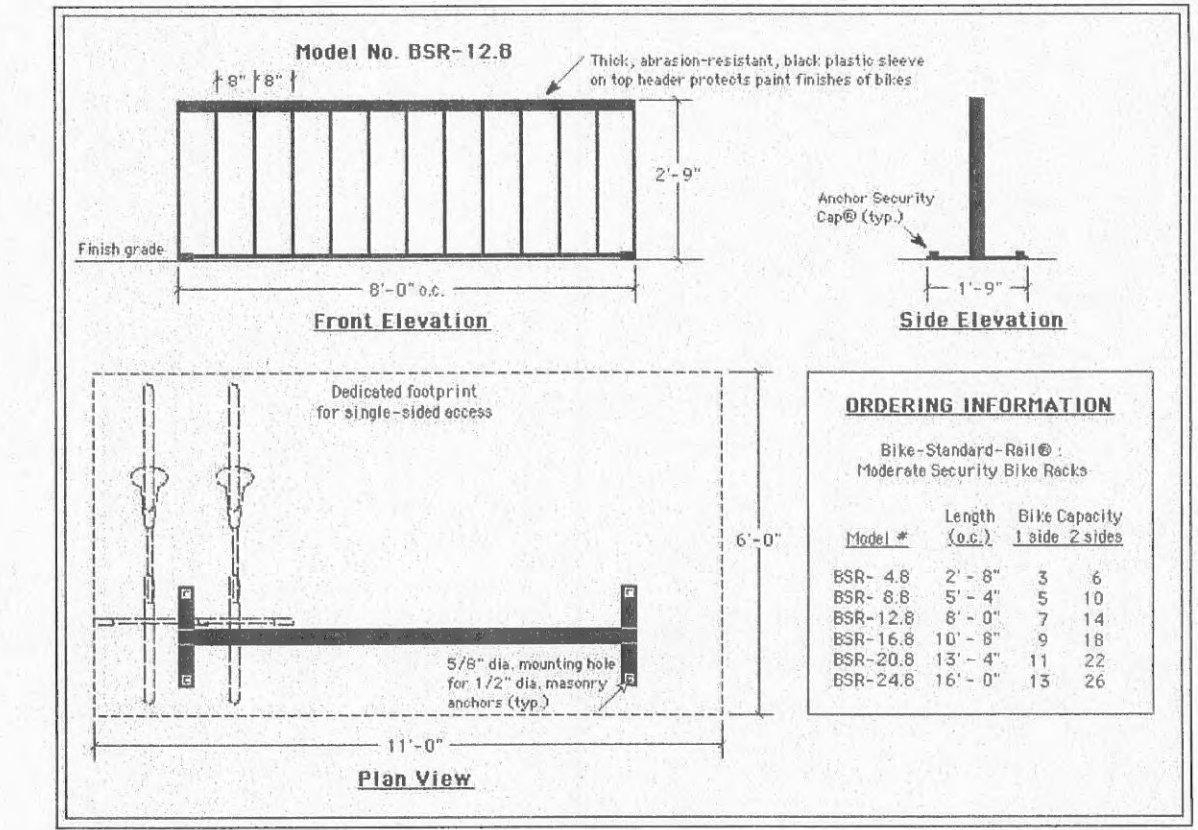
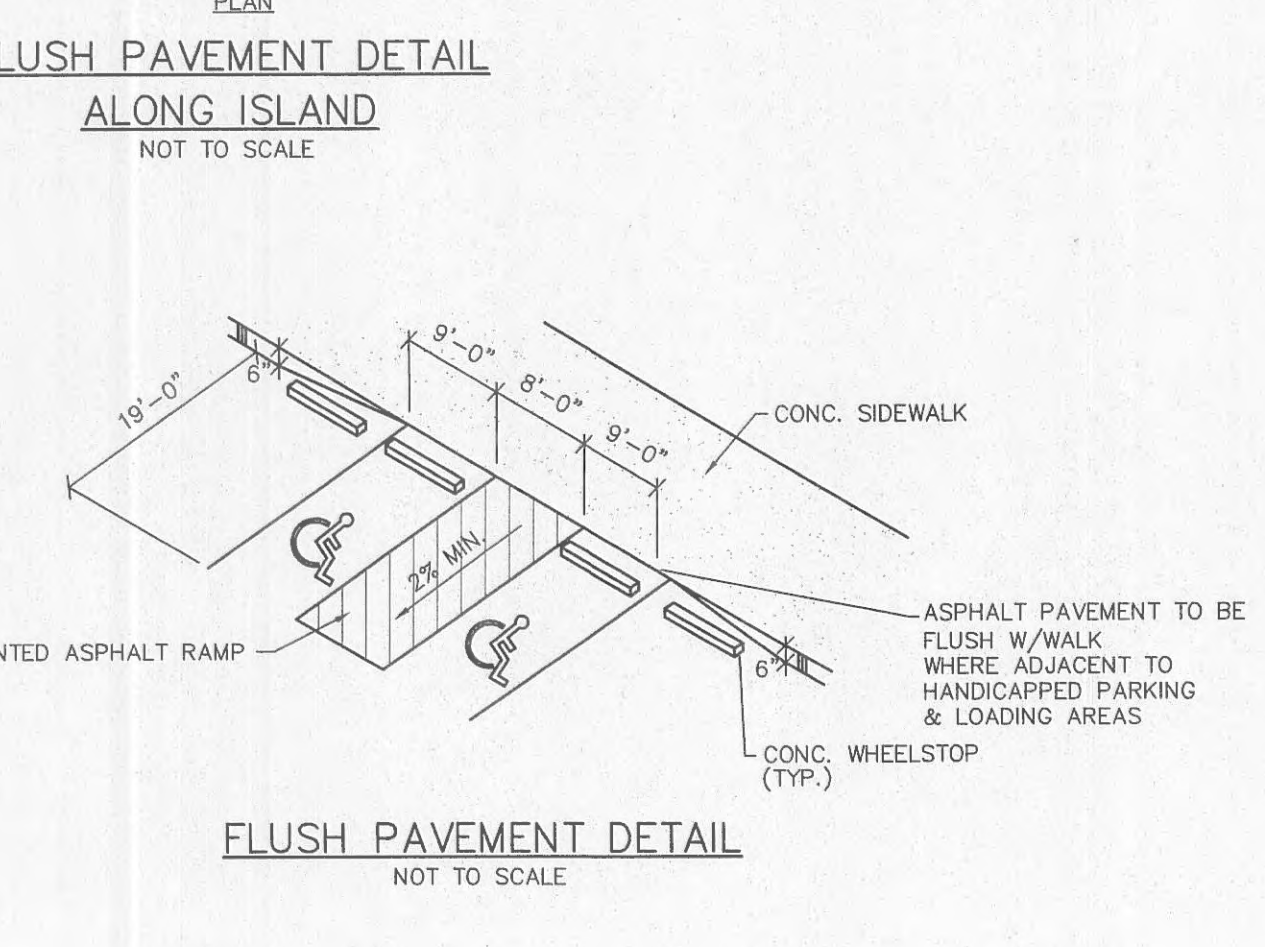
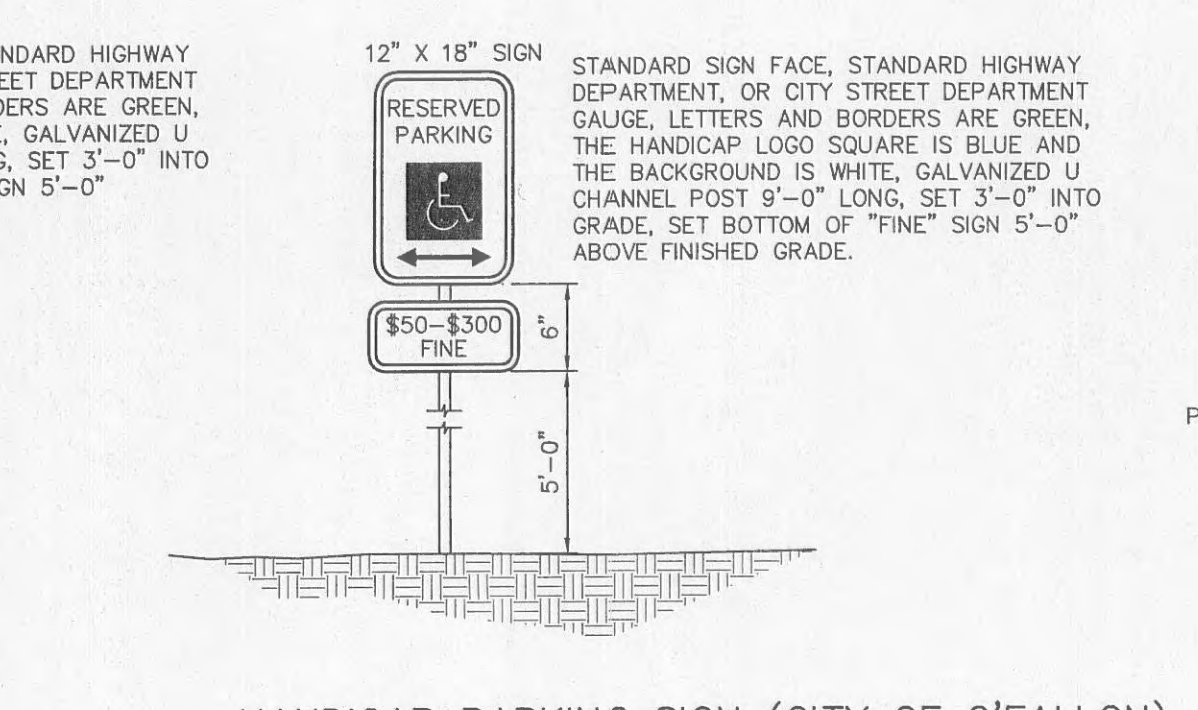
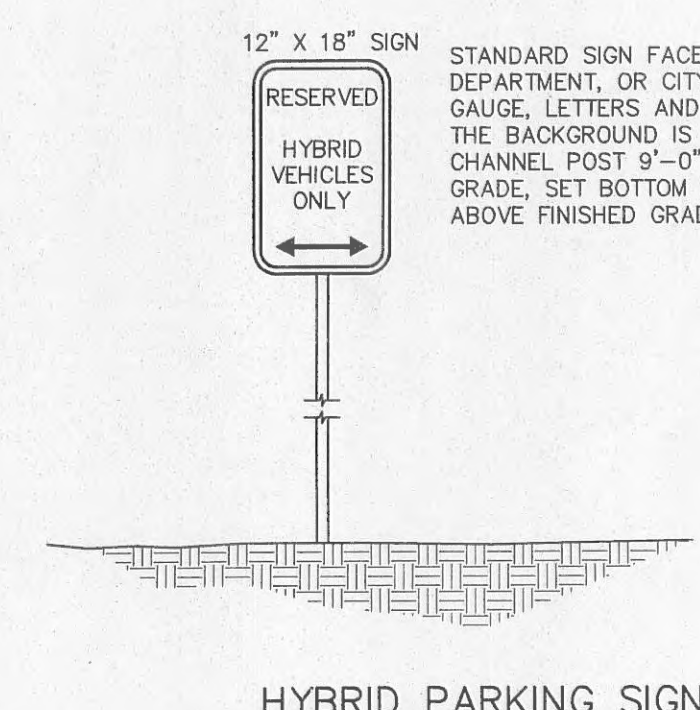
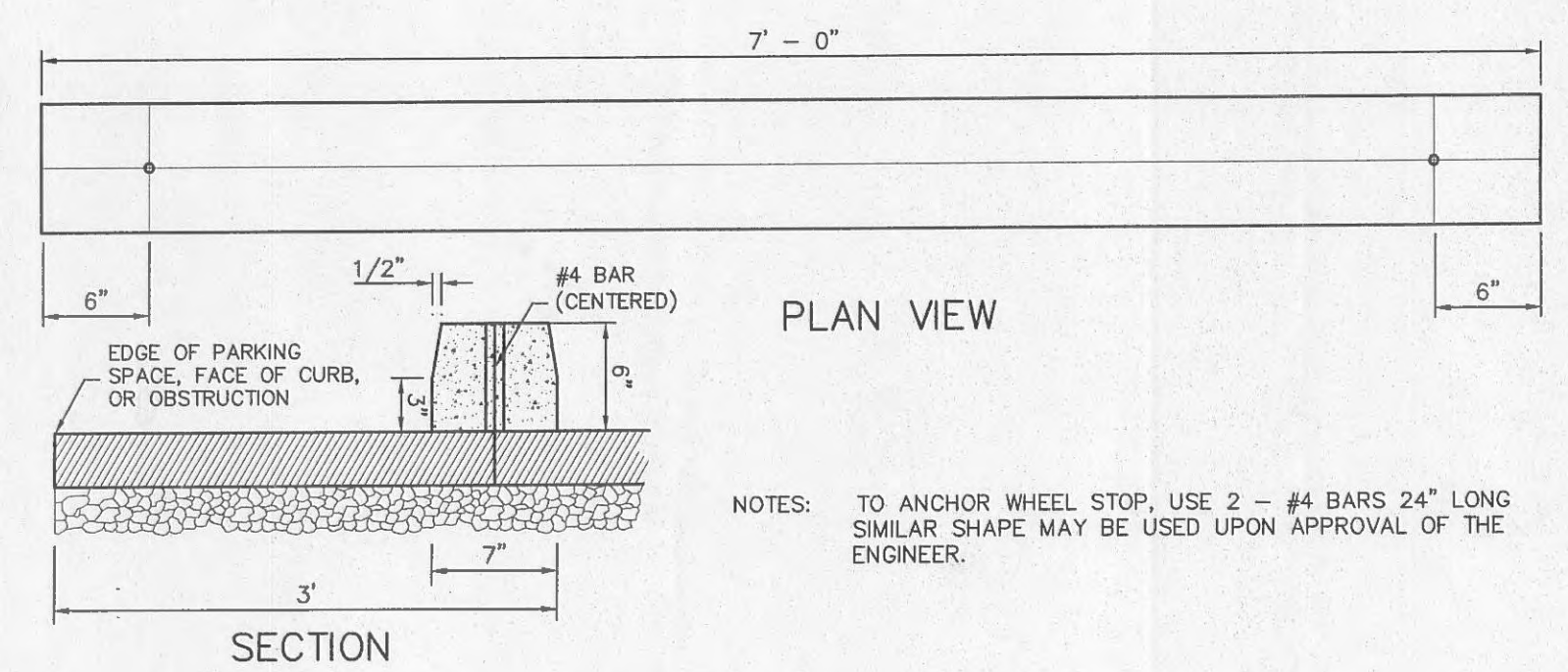
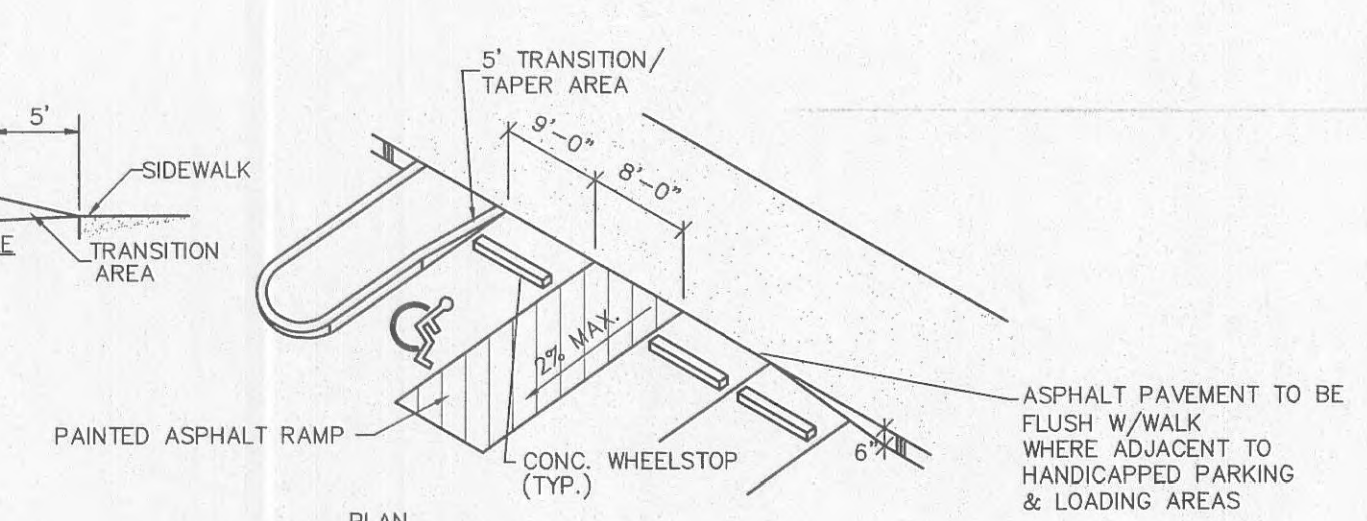
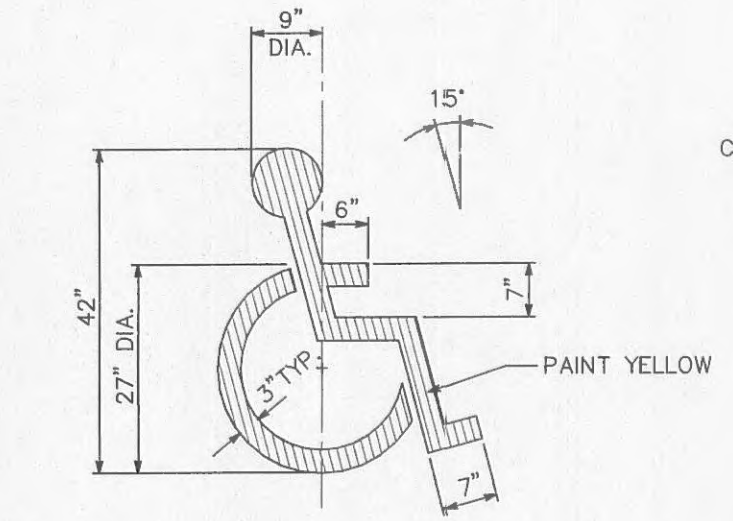
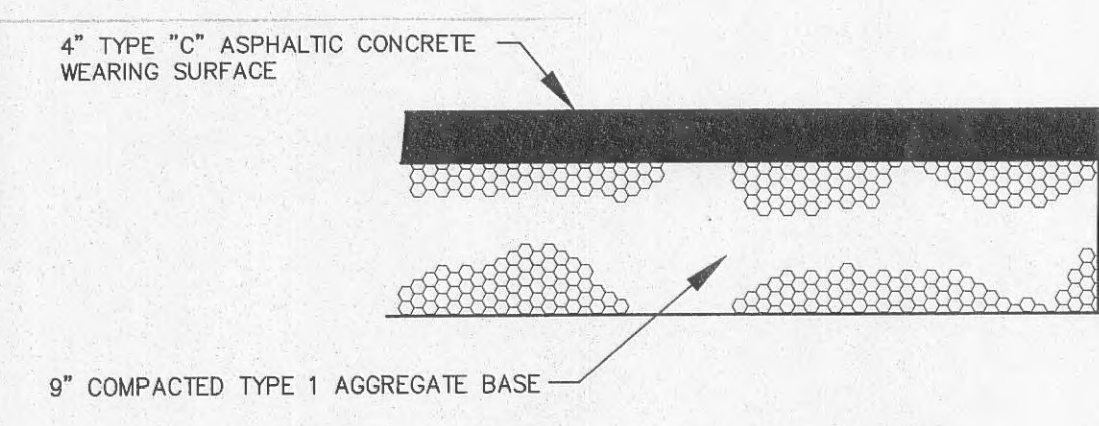
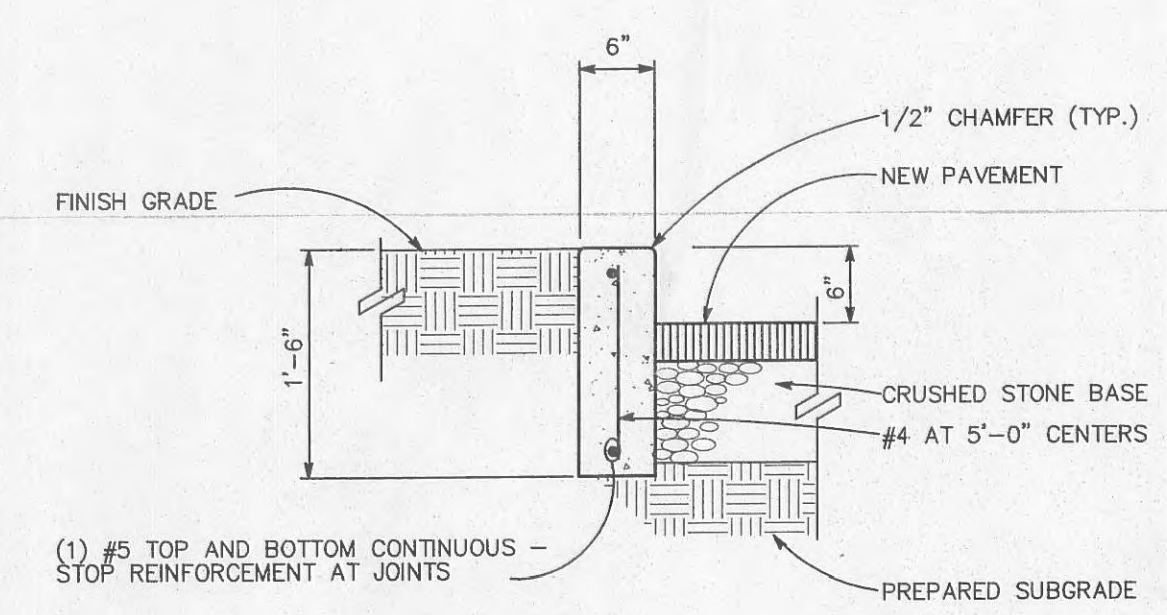
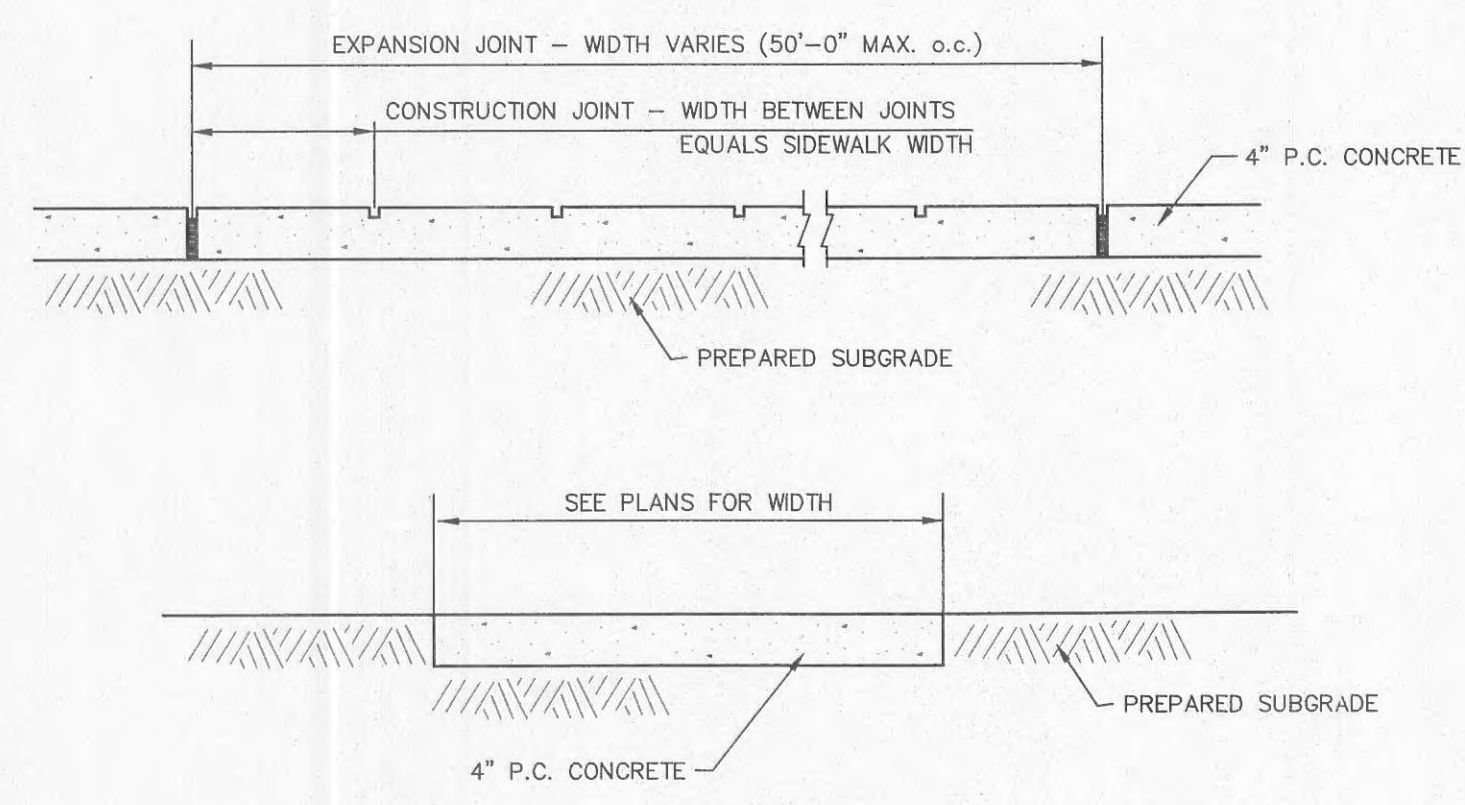
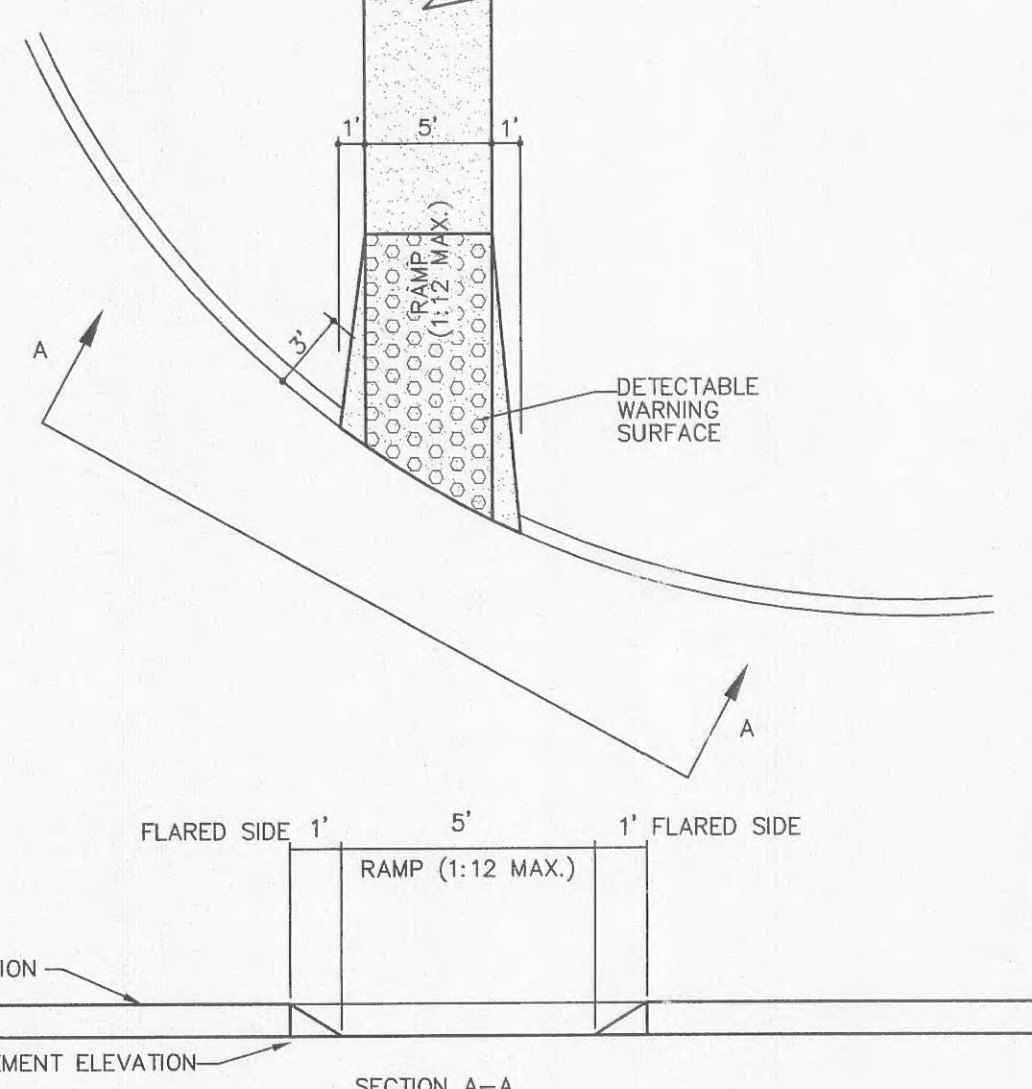
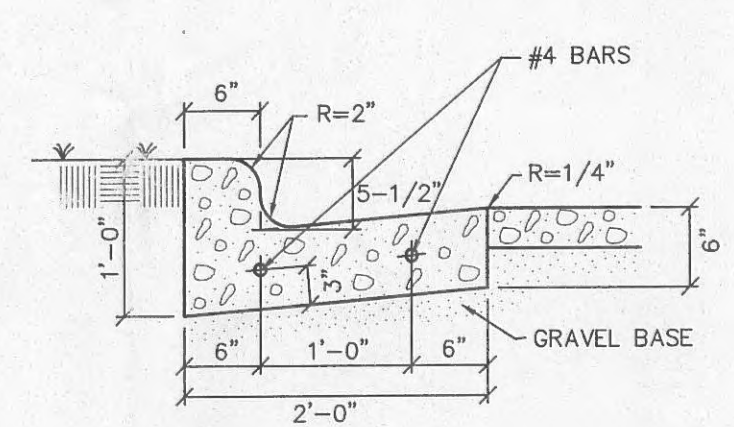
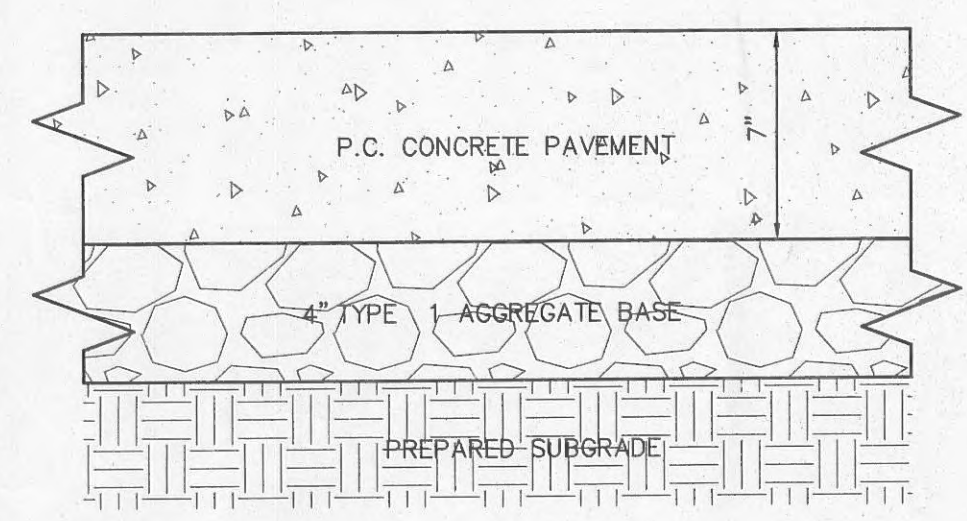

Armor-Tile
 Tactile Systems

ENGINEERED PLASTICS, INC.
 300 INTERNATIONAL DR., SUITE 100
 WILLIAMSVILLE, NY
 USA, 14221
 1 (800) 682-2525
 PHONE: (716) 628-3626
 FAX: 1 (800) 769-4463
 www.armor-tile.com

SELECT DESIRED COLOR:
 LIGHT GREY
 DARK GREY
 ONYX BLACK
 PEARL WHITE
 FEDERAL YELLOW
 BRICK RED
 CUSTOM (CONTACT MANUFACTURER)

DETAIL 1-1
 PLAN-TILE
 SECTION A-A
 SECTION B-B

NOTES:
 1. INSTALLATION TO BE COMPLETED IN ACCORDANCE WITH MANUFACTURER'S SPECIFICATIONS.
 2. DO NOT SCALE DRAWINGS.
 3. FOR CUSTOM SIZING CONTACT MANUFACTURER.
 4. CONTRACTORS NOTE: FOR PRODUCT AND COMPANY INFORMATION VISIT www.CADdetails.com/info REFERENCE NUMBER 681-001C.

CAST IN PLACE
 24" x 36" (ADA-C-2436)
 (OR APPROVED EQUIVALENT)

881-001C
 PROTECTED BY COPYRIGHT - 11/08/06
 www.CADdetails.com