

INSIDE DROP MANHOLE
DUCKETT CREEK SEWER DISTRICT
STANDARD CONSTRUCTION DETAIL
DETAIL NO. JAN. 1989

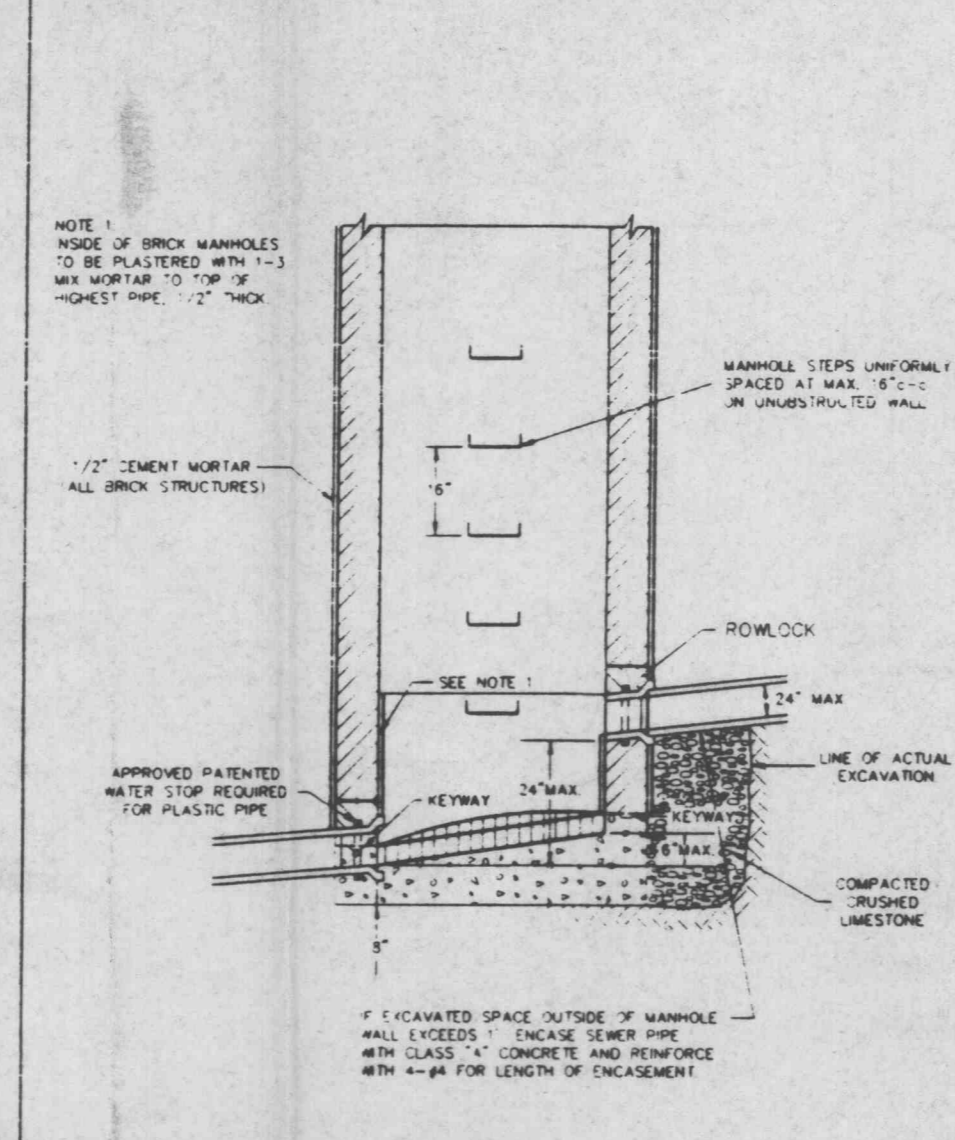

INSIDE FOULWATER DROP MANHOLE (FOR FREE-FALL)
METROPOLITAN ST. LOUIS SEWER DISTRICT
Standard Details of Sewer Construction
Dr. W.S.H. Ch. J.C.K. 1992 SHEET 16

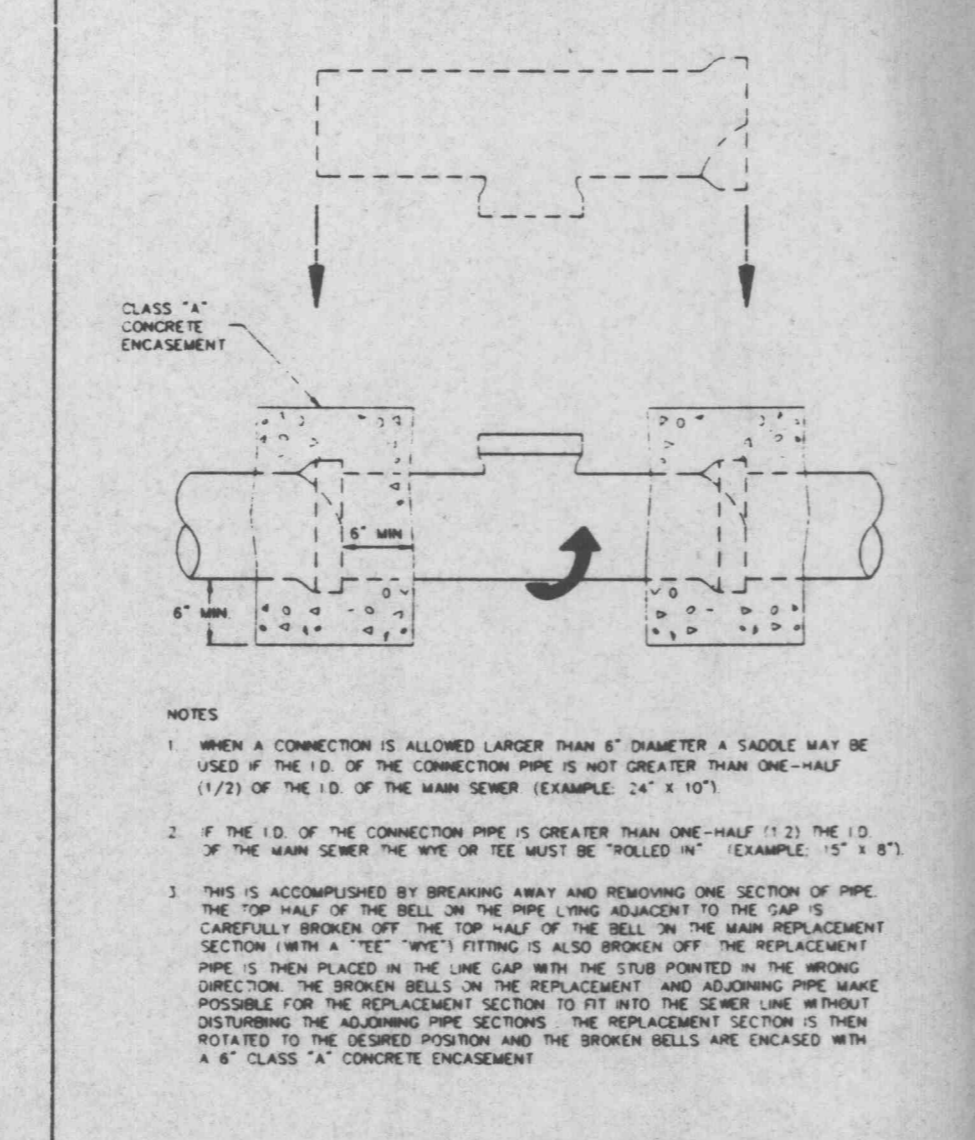

"ROLL-IN" (FOR EXISTING CLAY OR CONCRETE PIPE)
METROPOLITAN ST. LOUIS SEWER DISTRICT
Standard Details of Sewer Construction
Dr. D.A.B. Ch. J.C.K. 1992 SHEET 63

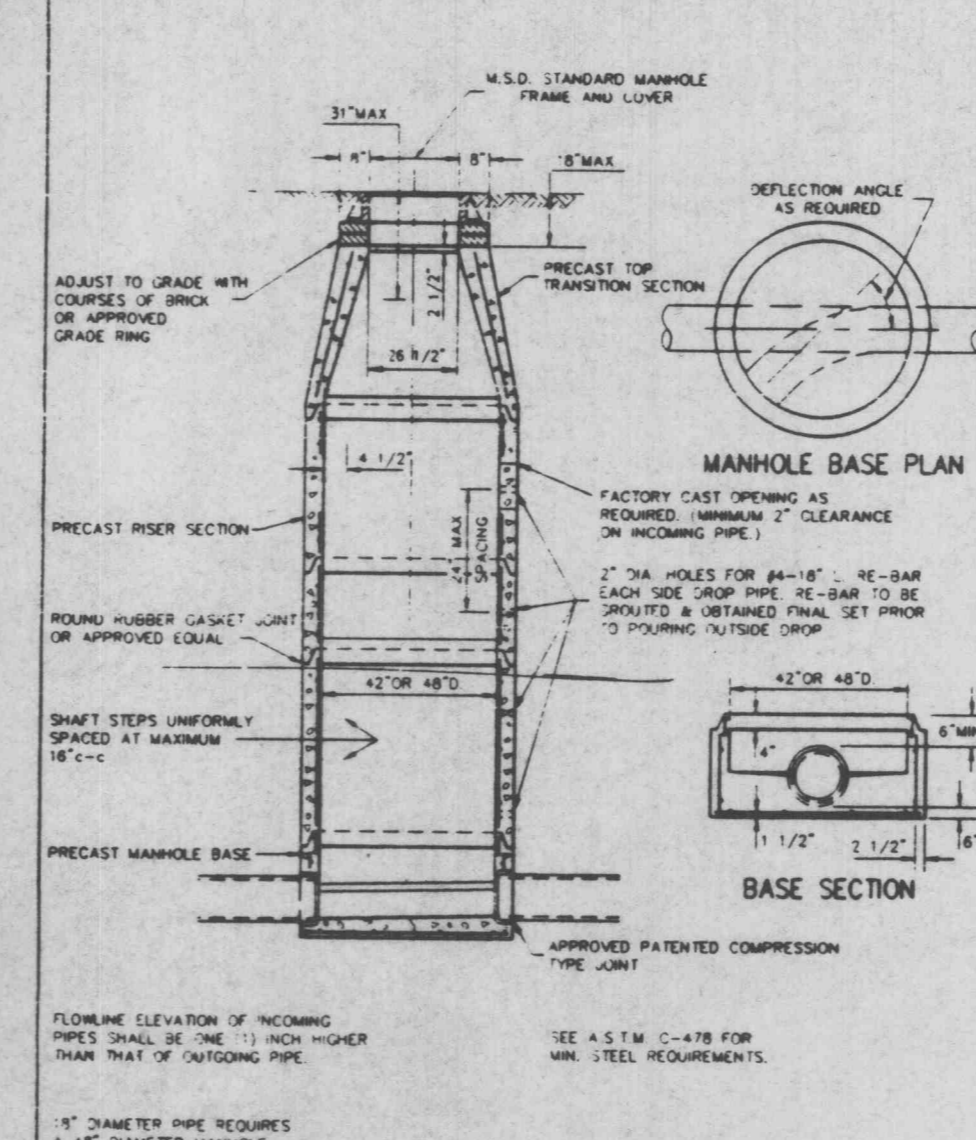

PRE-CAST CONCRETE MANHOLE FOR SEWERS 8" THROUGH 18"
METROPOLITAN ST. LOUIS SEWER DISTRICT
Standard Details of Sewer Construction
Dr. W.S.H. Ch. J.C.K. 1992 SHEET 18

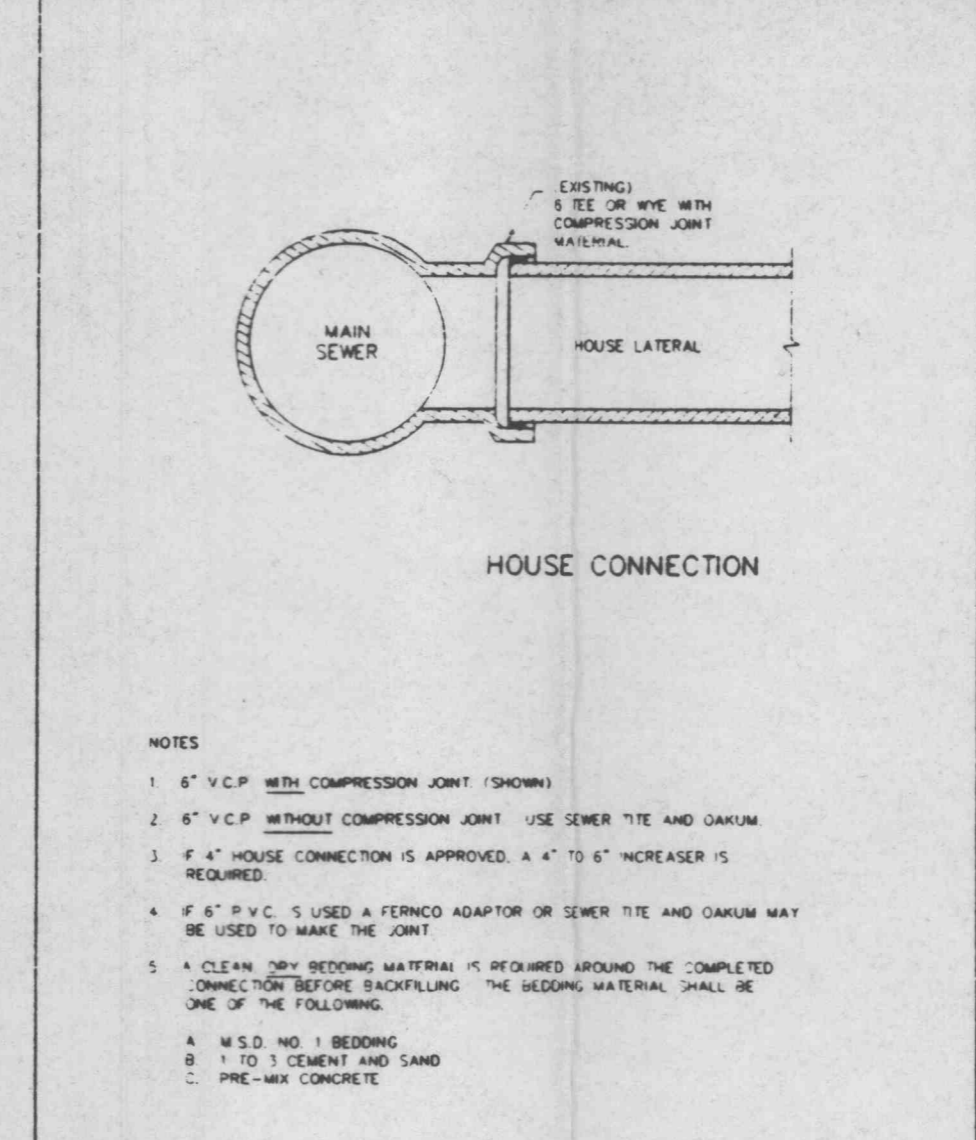

HOUSE CONNECTION TO EXISTING TEE OR WYE
METROPOLITAN ST. LOUIS SEWER DISTRICT
Standard Details of Sewer Construction
Dr. D.A.B. Ch. J.C.K. 1992 SHEET 59

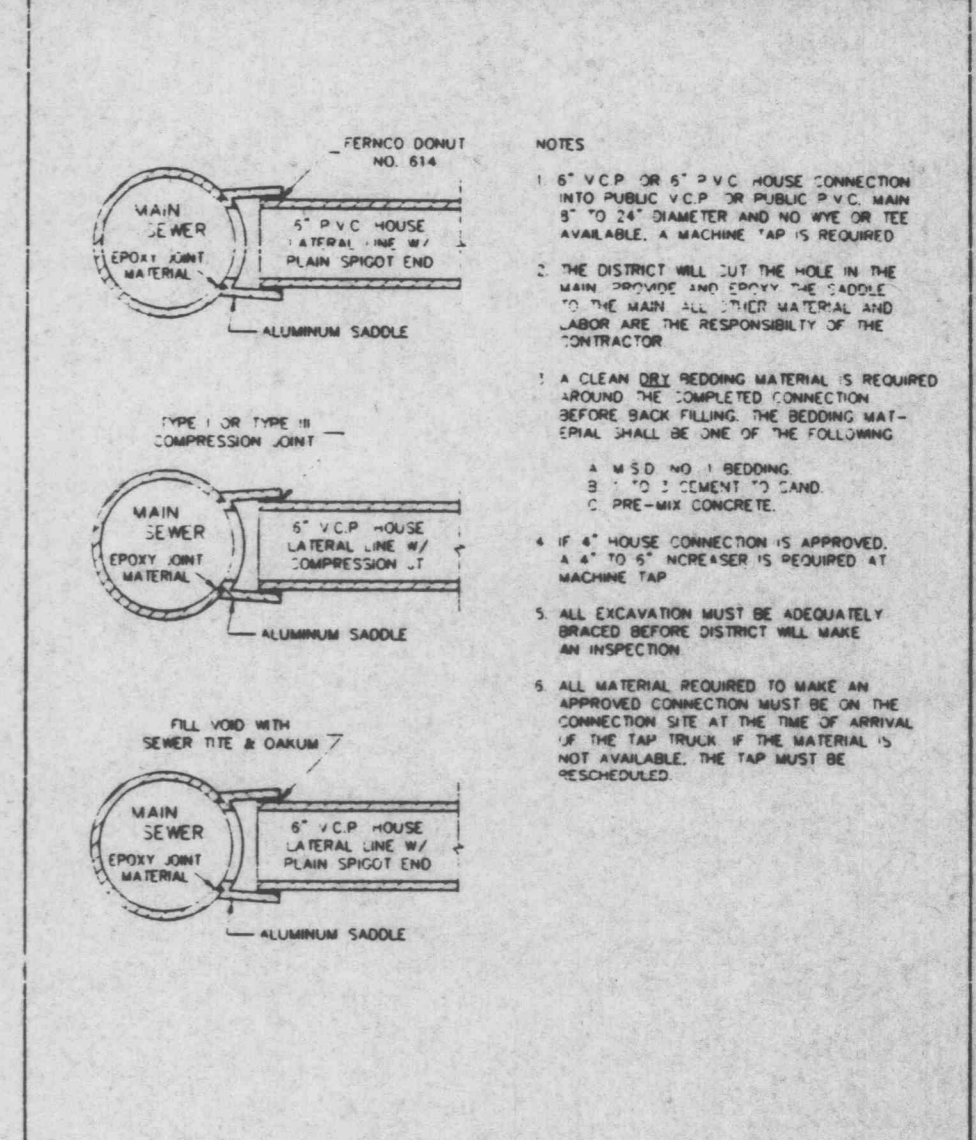

MACHINE TAP
METROPOLITAN ST. LOUIS SEWER DISTRICT
Standard Details of Sewer Construction
Dr. W.S.H. Ch. J.C.K. 1992 SHEET 60

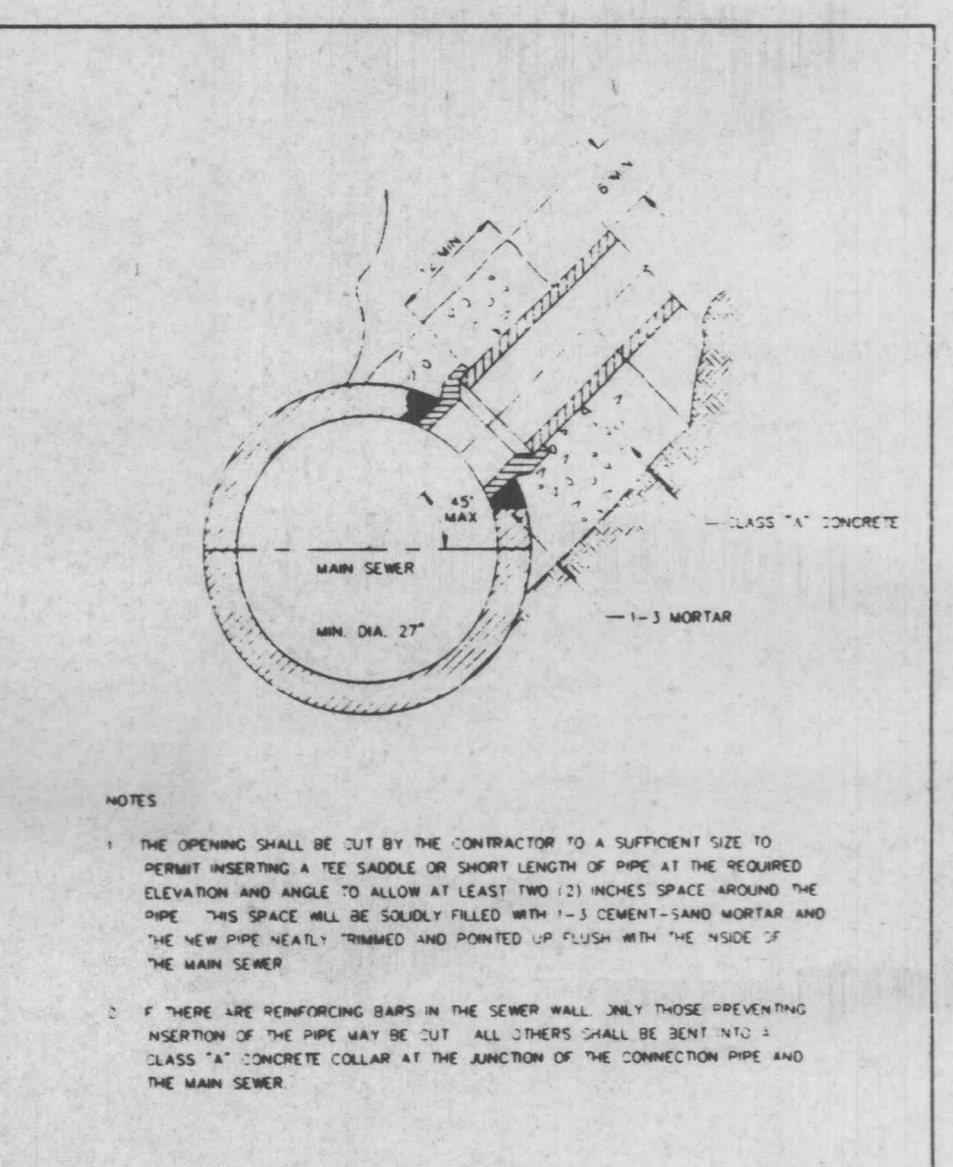

HOUSE CONNECTIONS ALLOWED BY TEE SADDLE
METROPOLITAN ST. LOUIS SEWER DISTRICT
Standard Details of Sewer Construction
Dr. D.A.B. Ch. J.C.K. 1992 SHEET 61

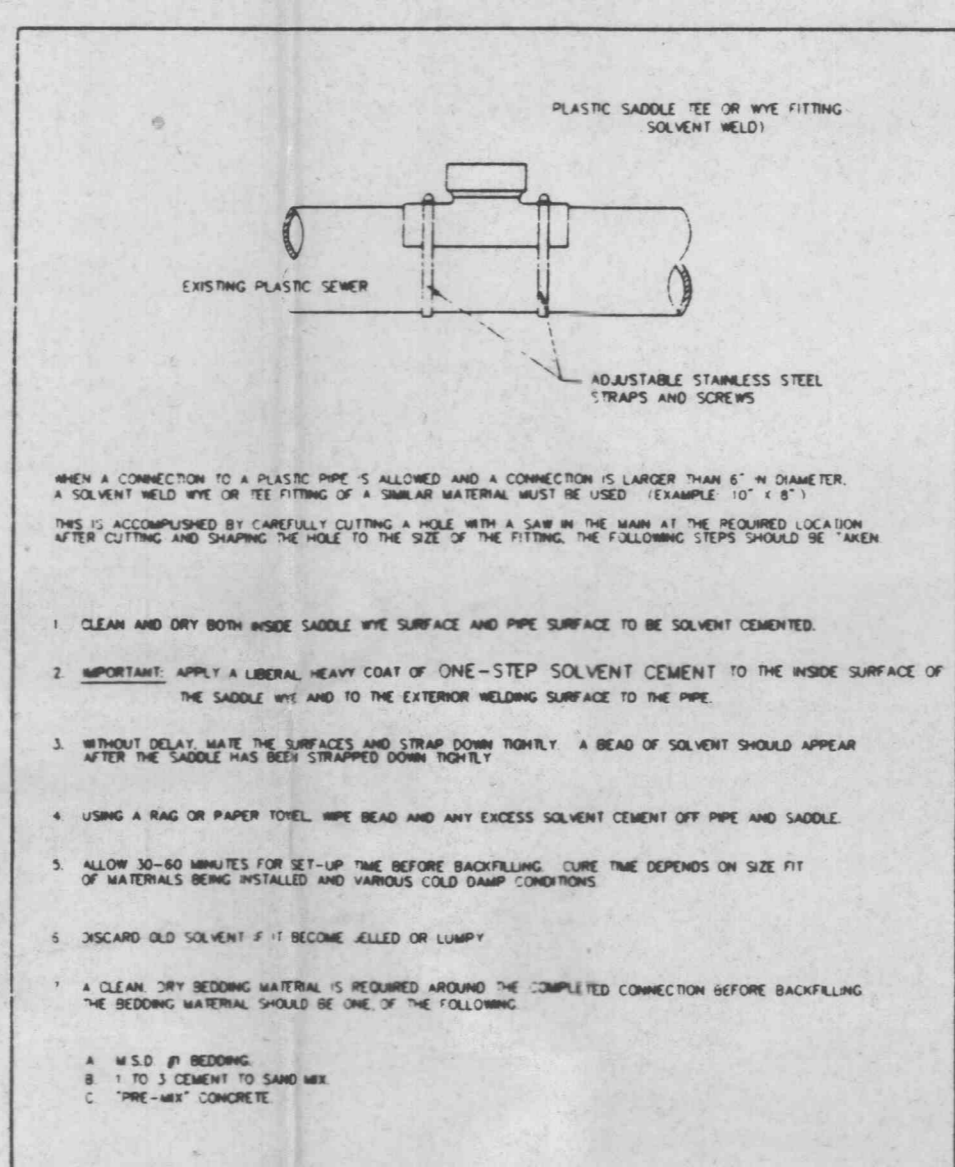

8" (& LARGER) CONNECTION TO PLASTIC MAIN
METROPOLITAN ST. LOUIS SEWER DISTRICT
Standard Details of Sewer Construction
Dr. D.A.B. Ch. J.C.K. 1992 SHEET 62

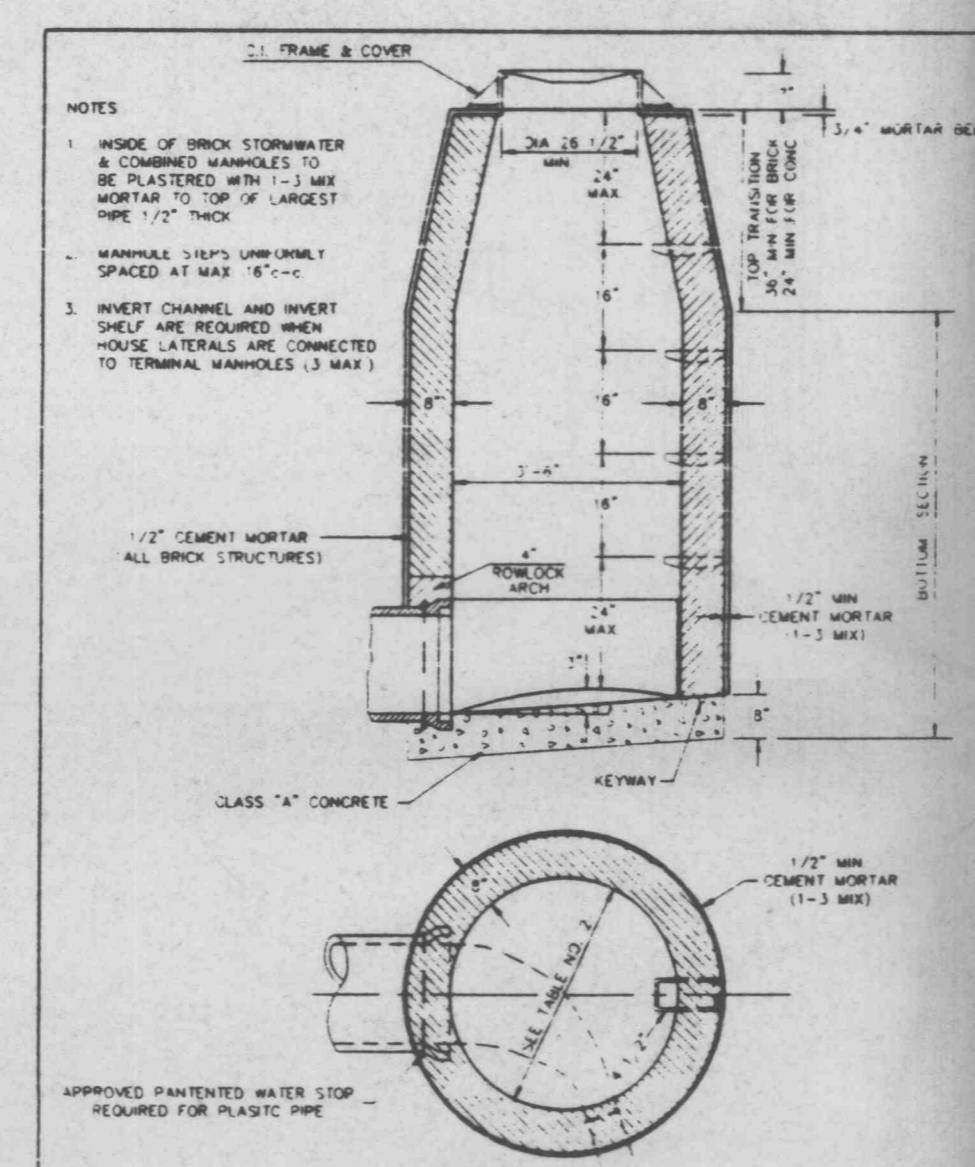

TERMINAL MANHOLE
METROPOLITAN ST. LOUIS SEWER DISTRICT
Standard Details of Sewer Construction
Dr. W.S.H. Ch. J.C.K. 1992 SHEET 17

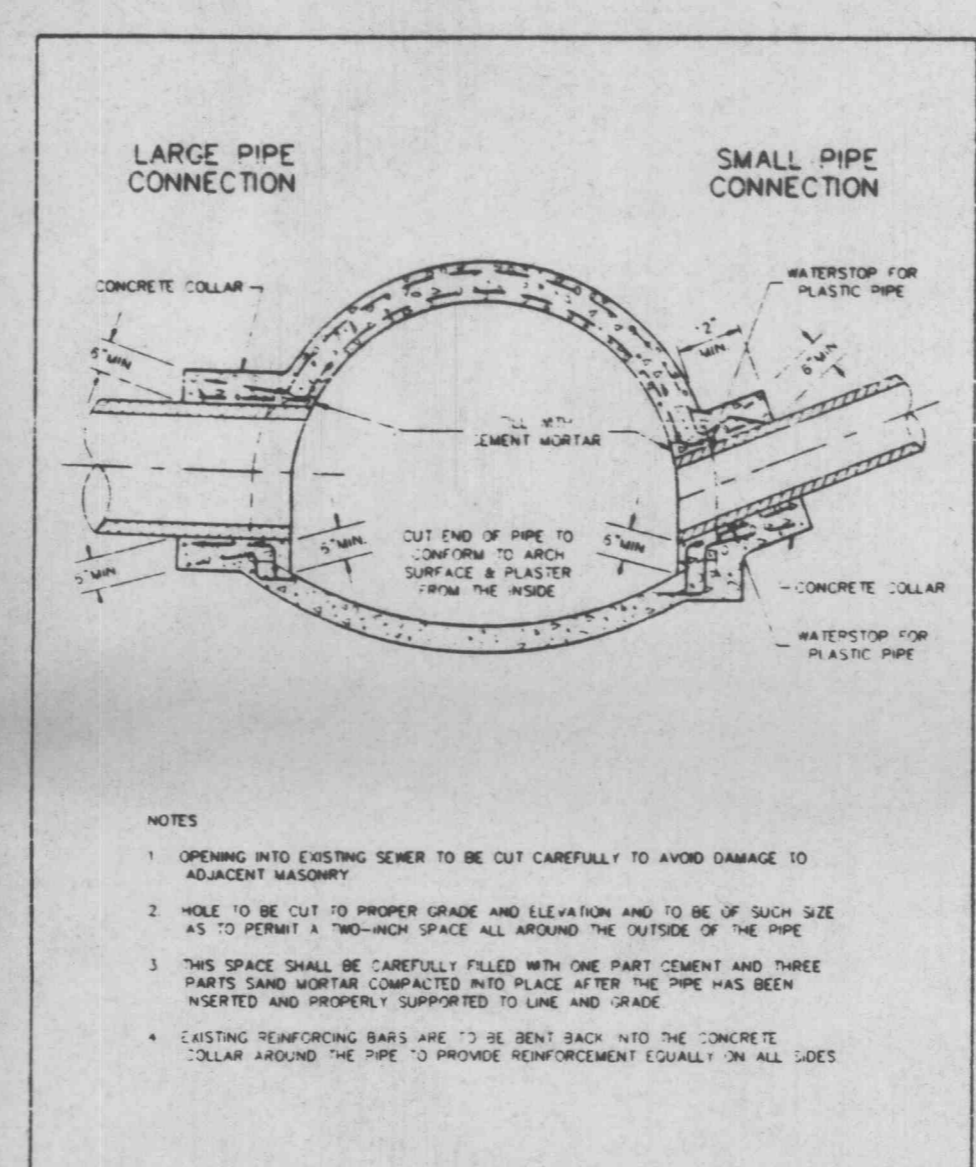

CONNECTIONS TO LARGE SEWERS
METROPOLITAN ST. LOUIS SEWER DISTRICT
Standard Details of Sewer Construction
Dr. W.S.H. Ch. J.C.K. 1992 SHEET 64

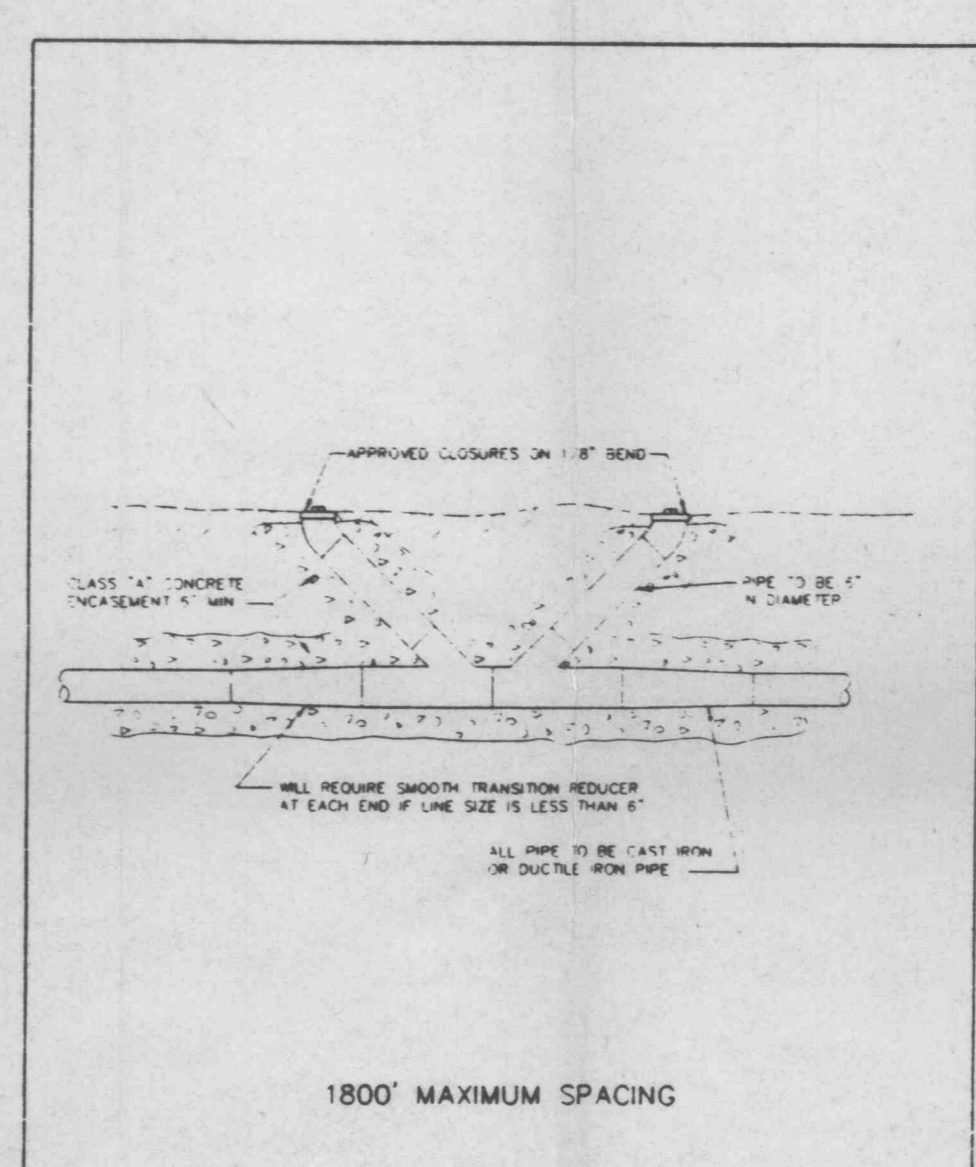

FORCE MAIN CLEANOUT (6" DIA. & SMALLER)
METROPOLITAN ST. LOUIS SEWER DISTRICT
Standard Details of Sewer Construction
Dr. R.G.W. Ch. J.C.K. 1992 SHEET 55

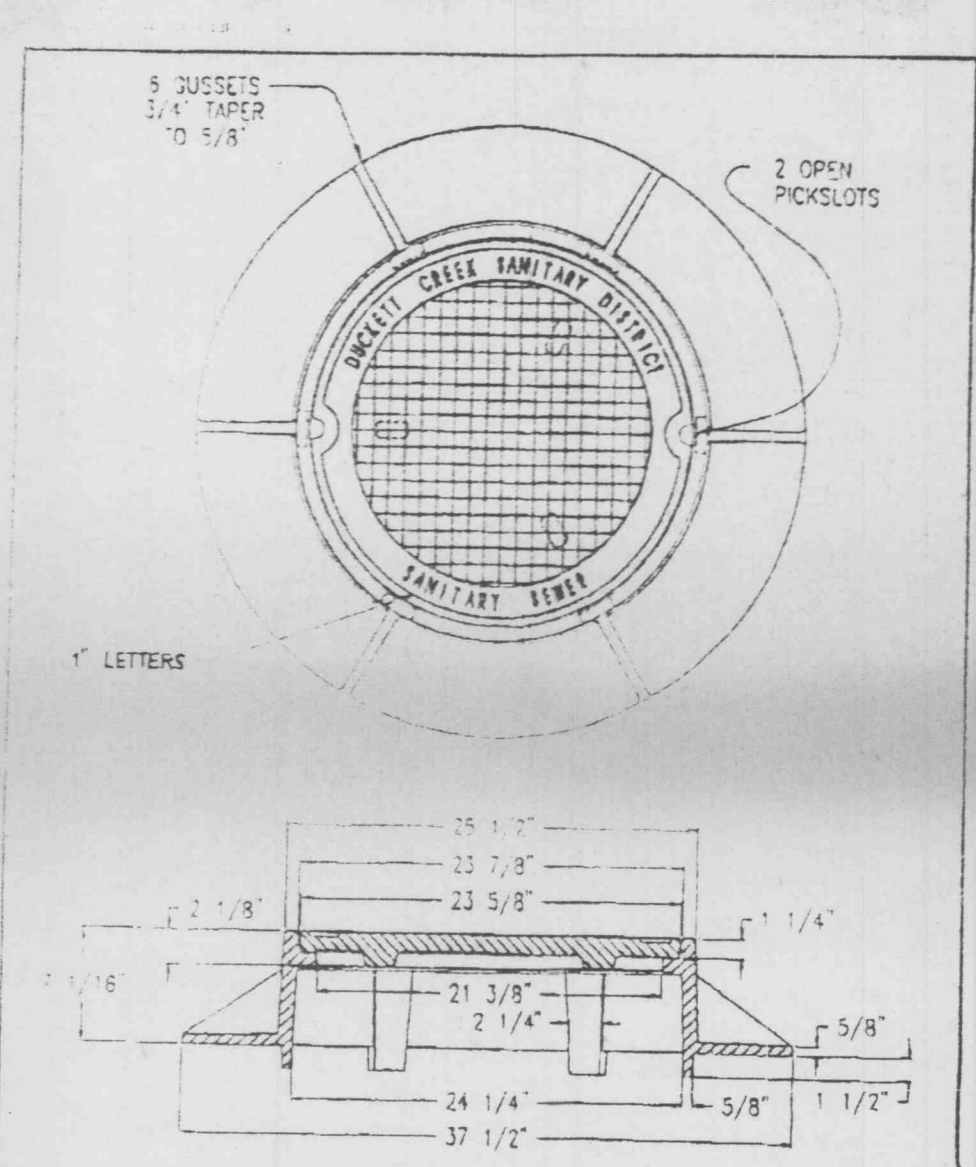

MANHOLE RING & COVER
DUCKETT CREEK SANITARY DISTRICT
STANDARD CONSTRUCTION DETAIL
DETAIL NO. MAY 1998

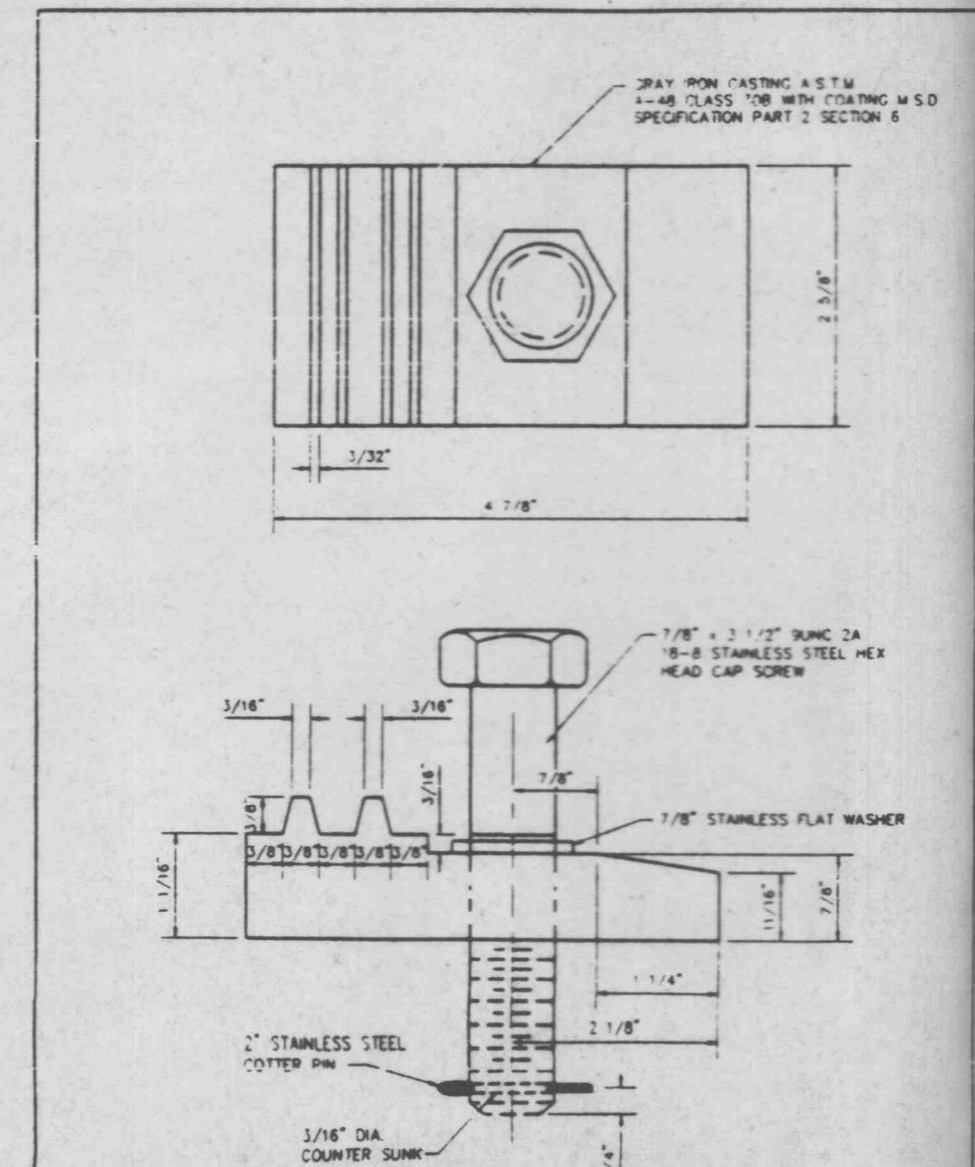

LOCKING DEVICE FOR TYPE 'T' LOCK TYPE MANHOLE COVER
METROPOLITAN ST. LOUIS SEWER DISTRICT
Standard Details of Sewer Construction
Dr. R.G.W. Ch. J.C.K. 1992 SHEET 51

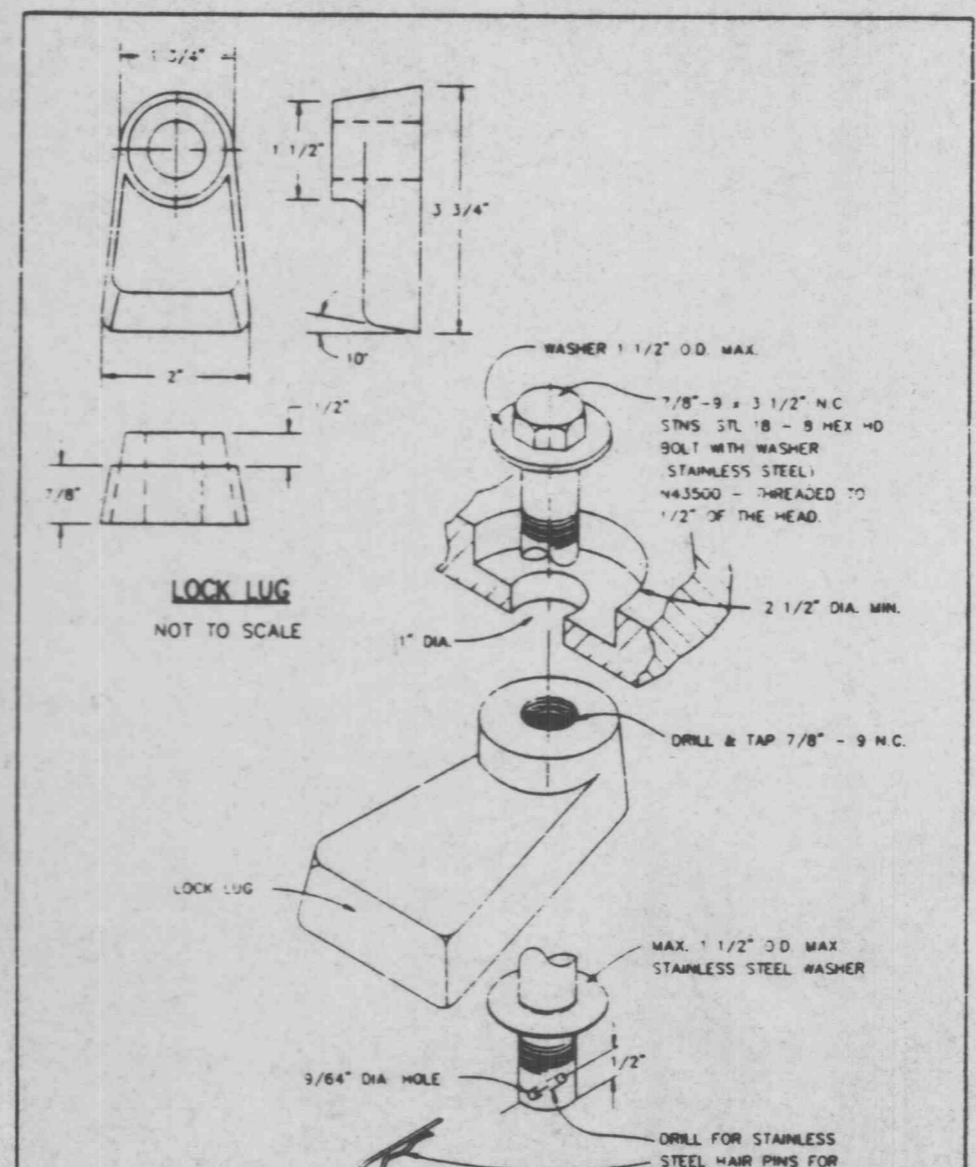

LOCKING DEVICE FOR TYPE 'N' LOCK TYPE MANHOLE COVER
METROPOLITAN ST. LOUIS SEWER DISTRICT
Standard Details of Sewer Construction
Dr. W.S.H. Ch. J.C.K. 1992 SHEET 52

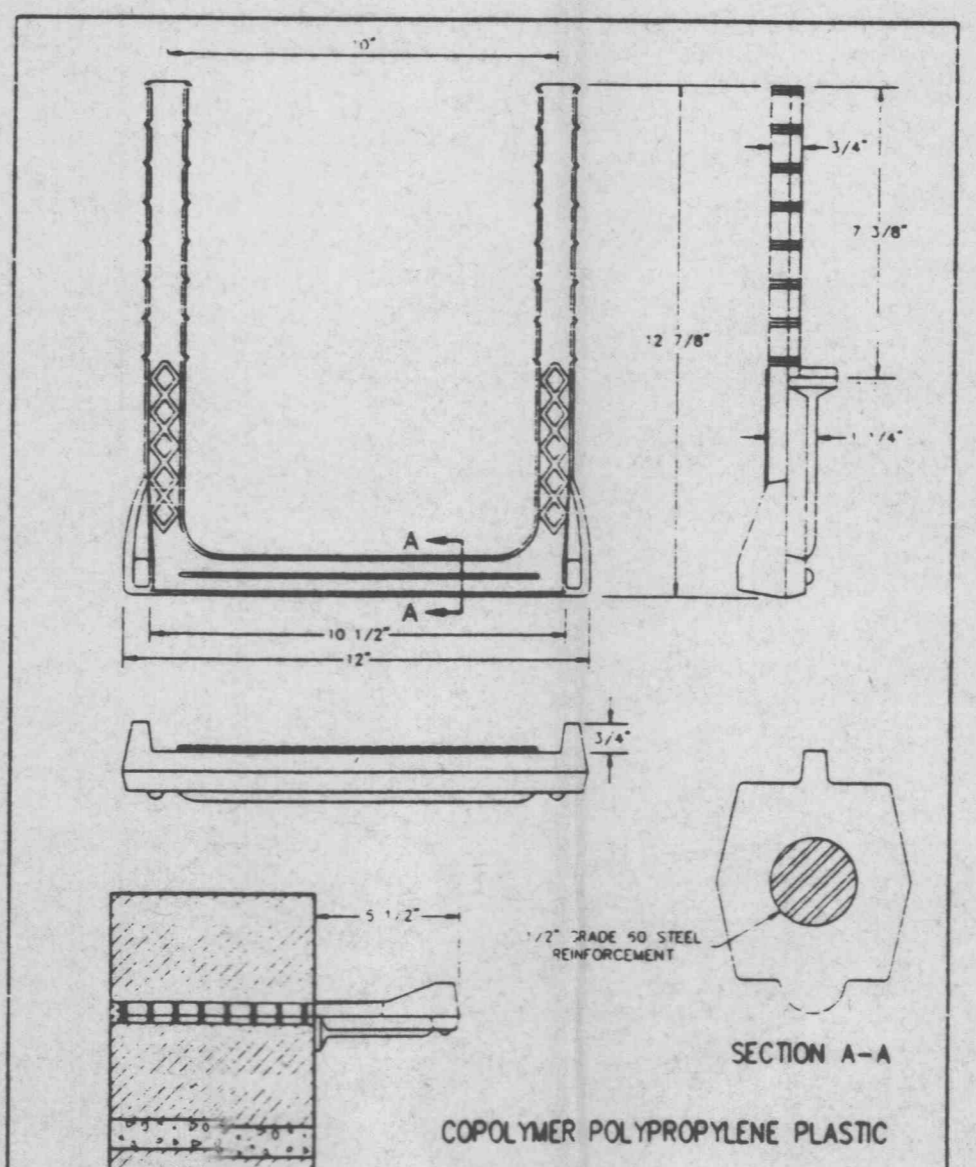

PSI-B MANHOLE STEP INTO JOINT
METROPOLITAN ST. LOUIS SEWER DISTRICT
Standard Details of Sewer Construction
Dr. W.S.H. Ch. J.C.K. 1992 SHEET 53

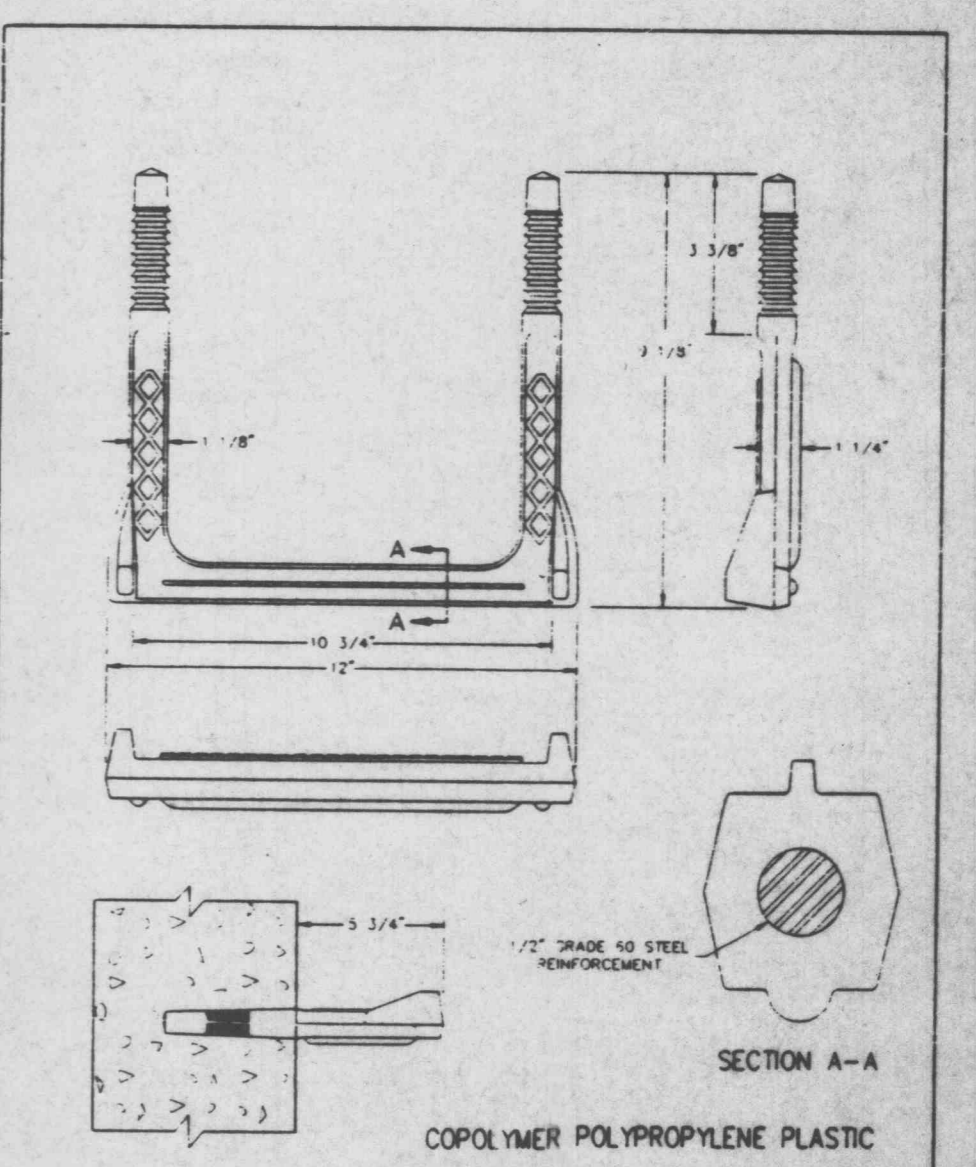

MANHOLE STEP FOR PRECAST MANHOLE
METROPOLITAN ST. LOUIS SEWER DISTRICT
Standard Details of Sewer Construction
Dr. D.A.B. Ch. J.C.K. 1992 SHEET 54