

ROUND PIPE				HORIZONTAL ELLIPTICAL PIPE			
PIPE DIAMETER (INCHES)	"W" PAYLINE WIDTH OF TRENCH (INCHES)	"W" PAYLINE WIDTH OF TRENCH (FEET)	PAY-VOLUMES (CU. FT. PER FT.)	CONCRETE ENCASEMENT (INCHES)	"W" PAYLINE WIDTH OF TRENCH (INCHES)	"W" PAYLINE WIDTH OF TRENCH (FEET)	PAY-VOLUMES (CU. FT. PER FT.)
4	30	2.50	3.28				
6	30	2.50	3.59				
8	30	2.50	3.87				
10	30	2.50	4.06				
12	30	2.50	4.25				
15	36	3.00	5.55				
18	36	3.00	5.77	14 x 23	41	3.42	5.94
21	36	3.00	6.01				
24	42	3.50	7.39	19 x 30	49	4.04	7.88
27	42	3.50	7.68	22 x 34	53	4.42	8.61
30	48	4.00	9.30	24 x 38	58	4.83	9.70
33	48	4.00	9.55	27 x 42	62	5.17	10.71
36	48	4.00	9.81	29 x 45	66	5.50	11.72
39	54	4.50	11.43	32 x 48	71	5.92	13.14
42	54	4.50	11.70	34 x 53	75	6.25	14.05
45	54	4.50	12.00	36 x 58	80	6.62	15.18
48	60	5.00	13.67	41 x 68	92	7.87	18.81
51	60	5.00	14.00	43 x 74	97	8.32	19.99
54	66	5.50	15.84	48 x 86	108	9.63	23.59
57	66	5.50	16.20	50 x 92	113	10.08	24.85
60	72	6.00	18.18	55 x 106	126	11.50	28.50
63	72	6.00	18.57	57 x 112	131	11.95	29.76
66	78	6.50	20.37	62 x 126	144	13.40	33.40
69	78	6.50	20.80	64 x 132	149	13.85	34.66
72	84	7.00	22.77	69 x 146	162	15.30	38.30
75	84	7.00	23.23	71 x 152	167	15.75	39.56
78	90	7.50	24.84	76 x 166	180	17.20	43.20
81	90	7.50	25.33	78 x 172	185	17.65	44.46
84	96	8.00	26.64	83 x 186	198	19.10	48.10
87	96	8.00	27.15	85 x 192	203	19.55	49.36
90	102	8.50	28.59	90 x 210	216	21.00	52.70
93	102	8.50	29.13	92 x 216	221	21.45	53.96
96	108	9.00	30.18	97 x 230	234	22.90	57.30
99	108	9.00	30.75	99 x 236	239	23.35	58.56
102	114	9.50	31.86	104 x 250	252	24.80	61.70
105	114	9.50	32.43	106 x 256	257	25.25	62.96
108	120	10.00	33.60	111 x 270	270	26.70	66.10
111	120	10.00	34.19	113 x 276	275	27.15	67.36
114	126	10.50	35.46	118 x 290	288	28.60	70.50
117	126	10.50	36.07	120 x 296	293	29.05	71.76
120	132	11.00	36.84	123 x 302	298	29.50	73.02
123	132	11.00	37.43	125 x 308	303	29.95	74.28
126	138	11.50	38.25	130 x 322	316	31.40	77.42
129	138	11.50	38.87	132 x 328	321	31.85	78.68
132	144	12.00	40.20	137 x 342	334	33.30	81.82
135	144	12.00	40.83	139 x 348	339	33.75	83.08
138	150	12.50	42.18	144 x 362	352	35.20	86.12
141	150	12.50	42.83	146 x 368	357	35.65	87.38

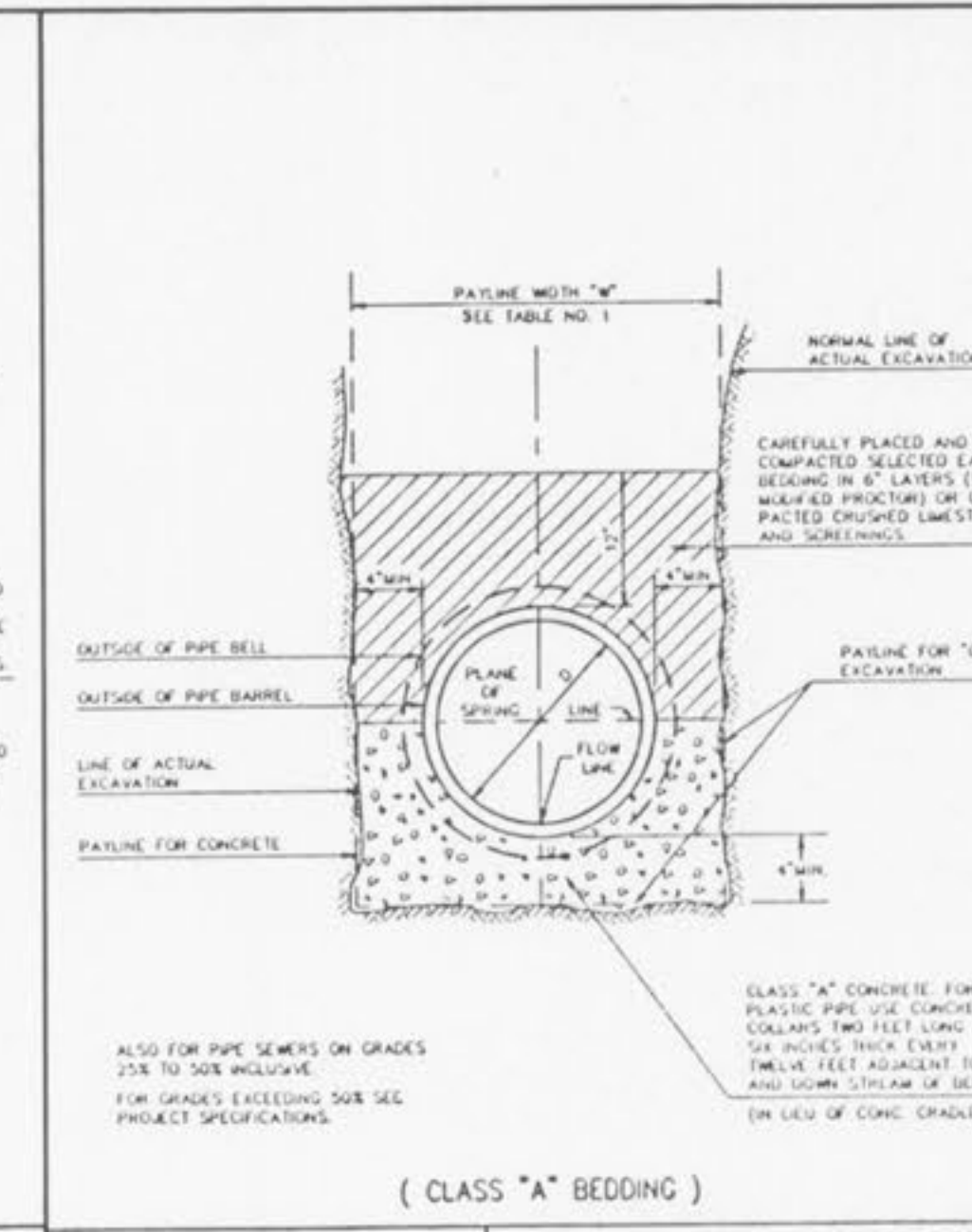
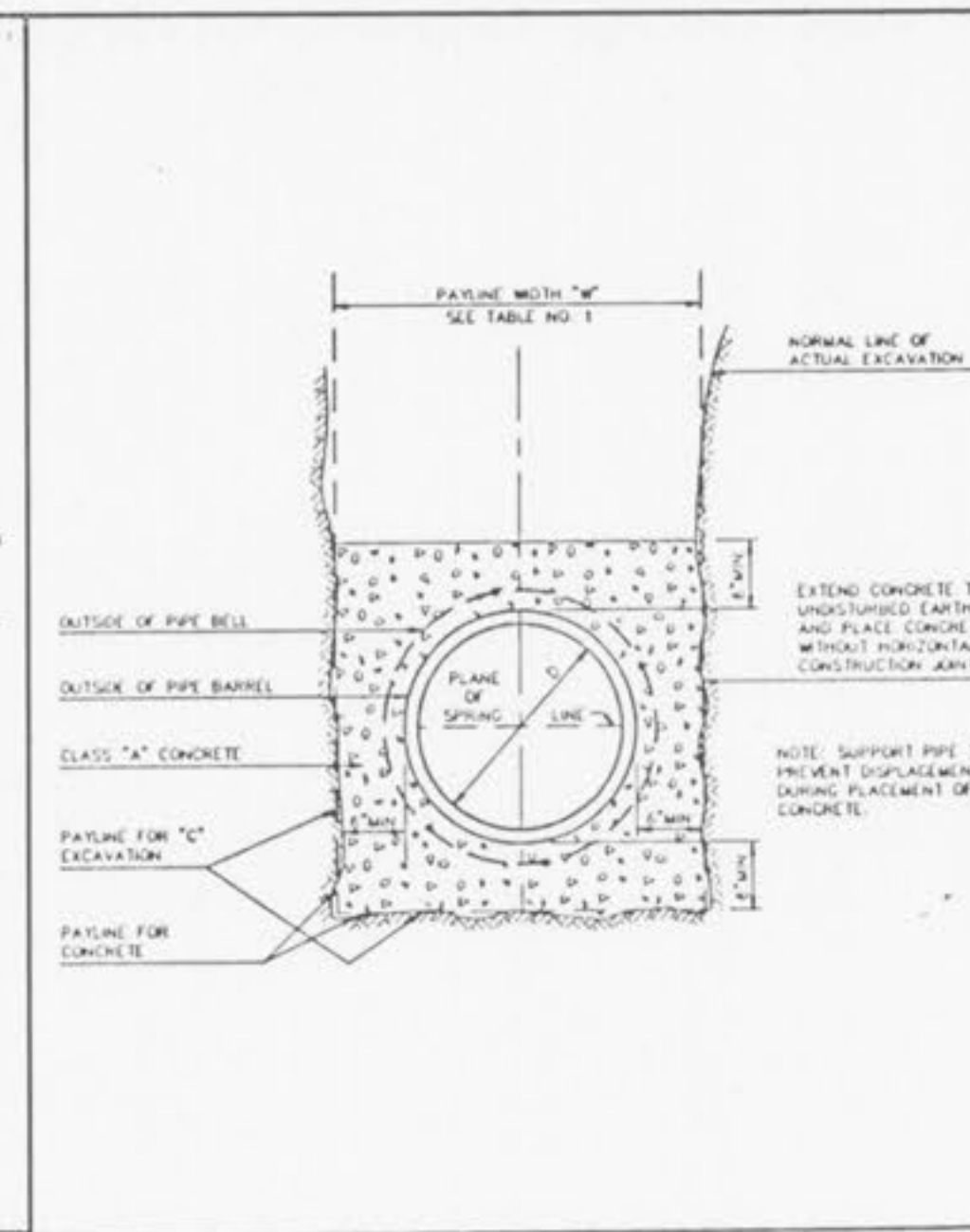
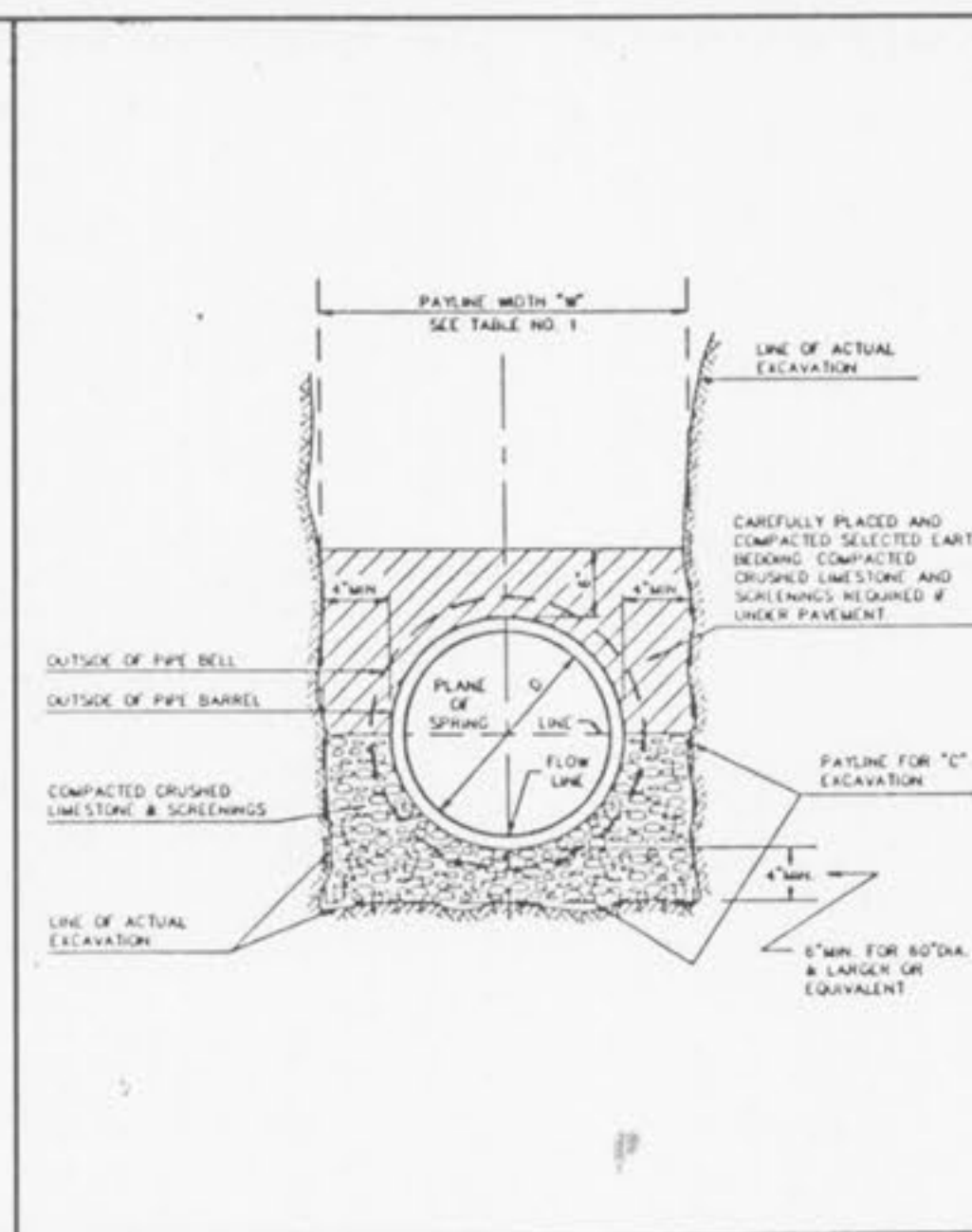
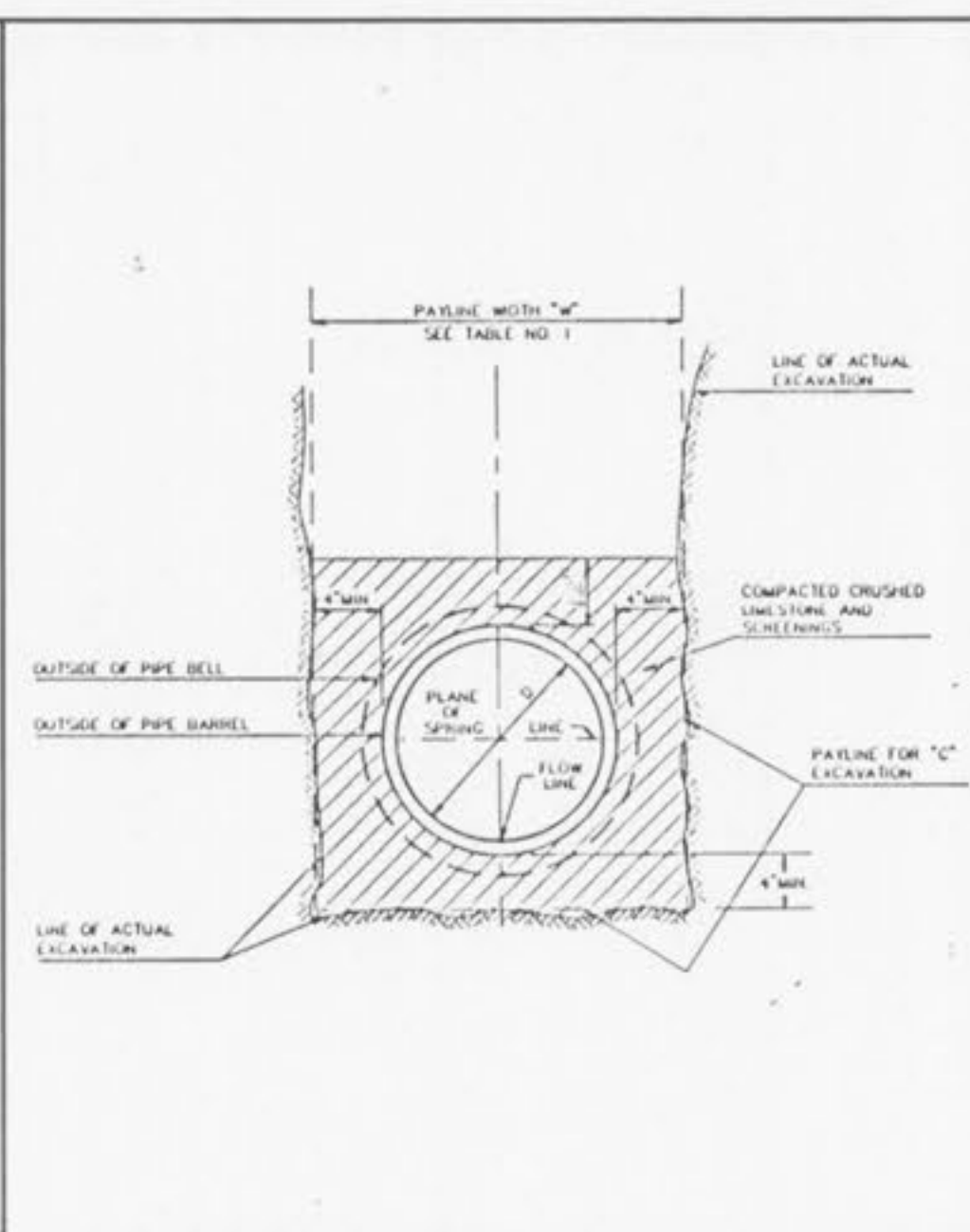
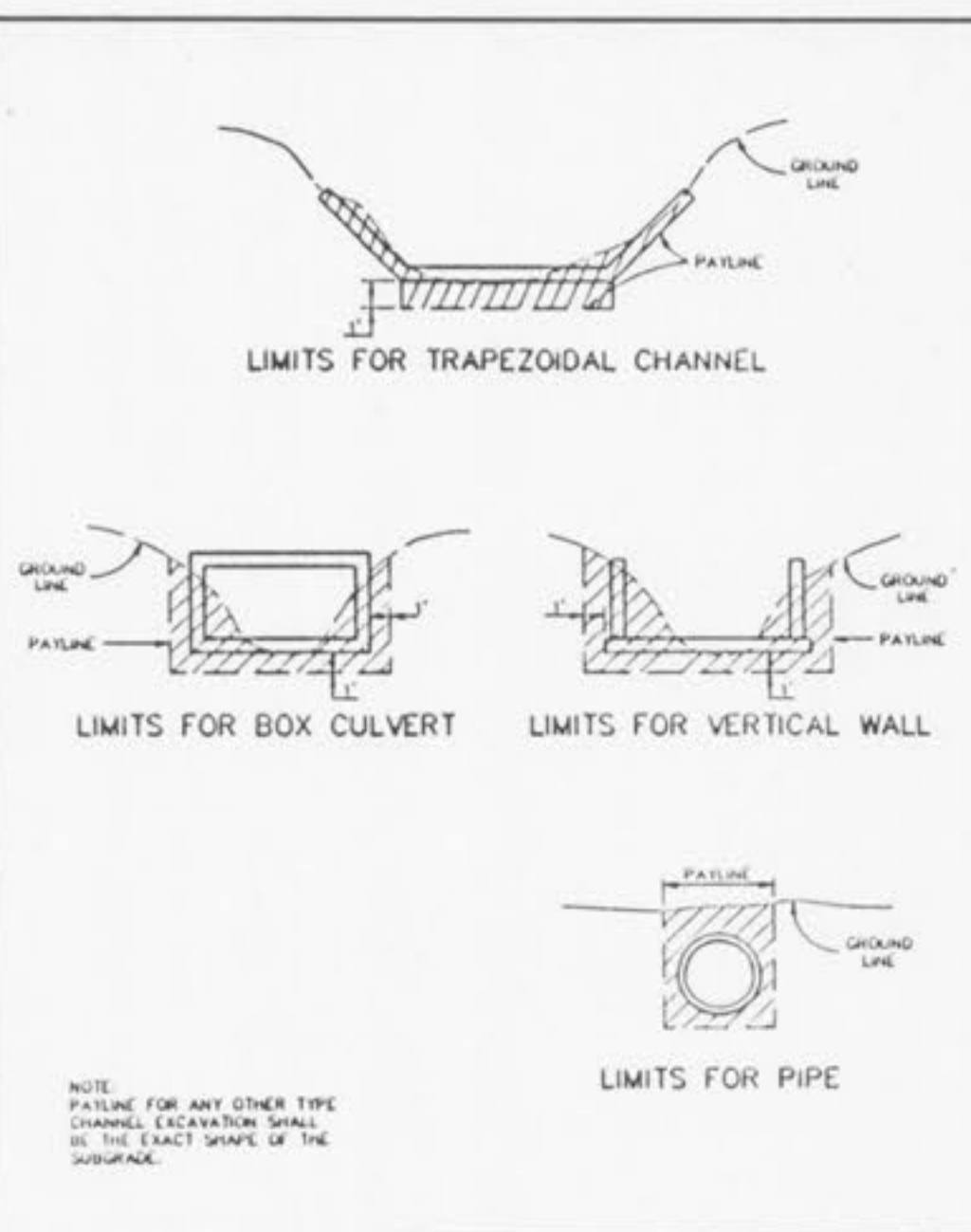

TABLE 1  
PAYLINE WIDTHS OF TRENCH AND PAY-QUANTITIES OF CONCRETE

METROPOLITAN ST. LOUIS SEWER DISTRICT  
Standard Details of Sewer Construction

METROPOLITAN ST. LOUIS SEWER DISTRICT  
Standard Details of Sewer Construction

METROPOLITAN ST. LOUIS SEWER DISTRICT  
Standard Details of Sewer Construction

METROPOLITAN ST. LOUIS SEWER DISTRICT  
Standard Details of Sewer Construction

METROPOLITAN ST. LOUIS SEWER DISTRICT  
Standard Details of Sewer Construction

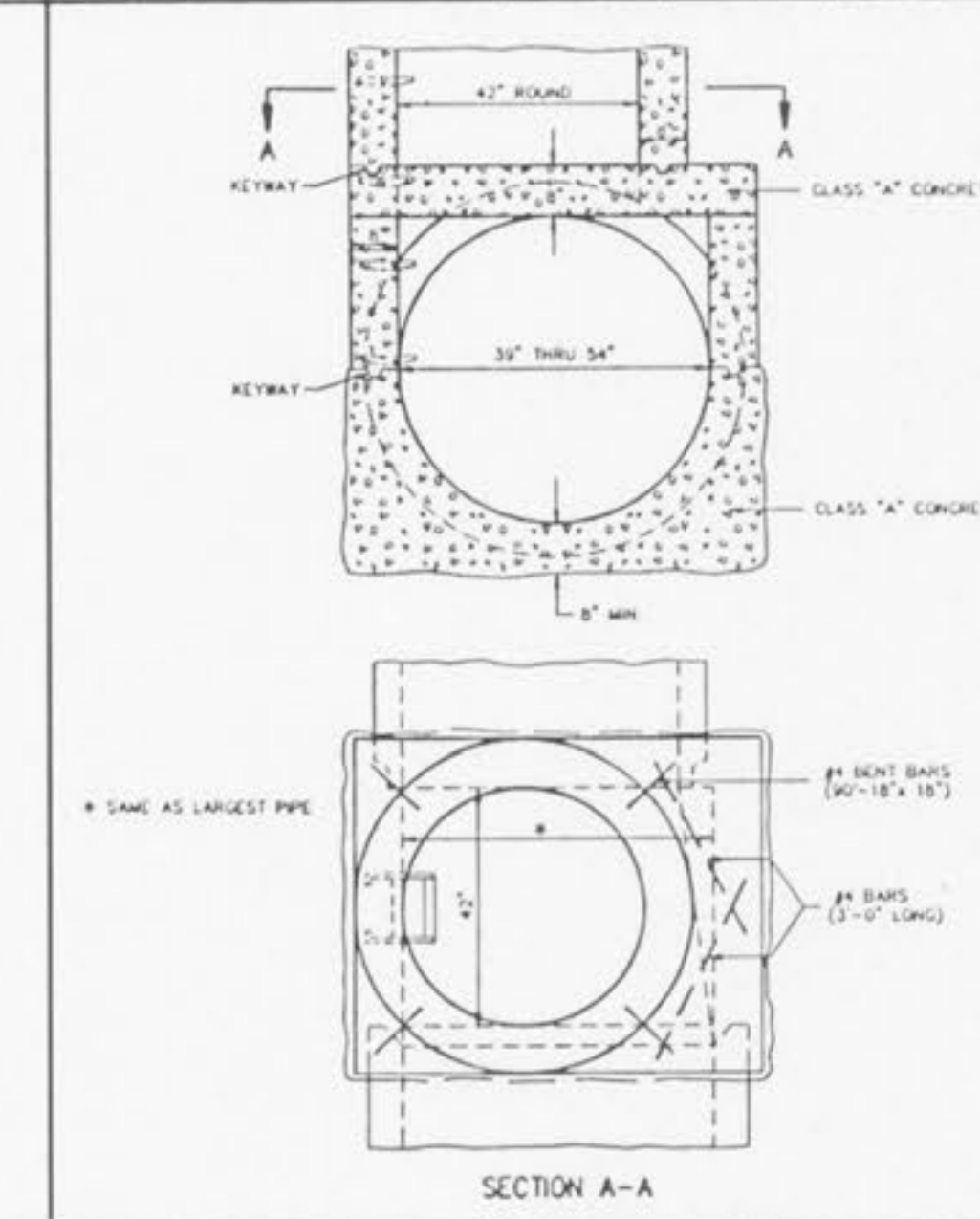
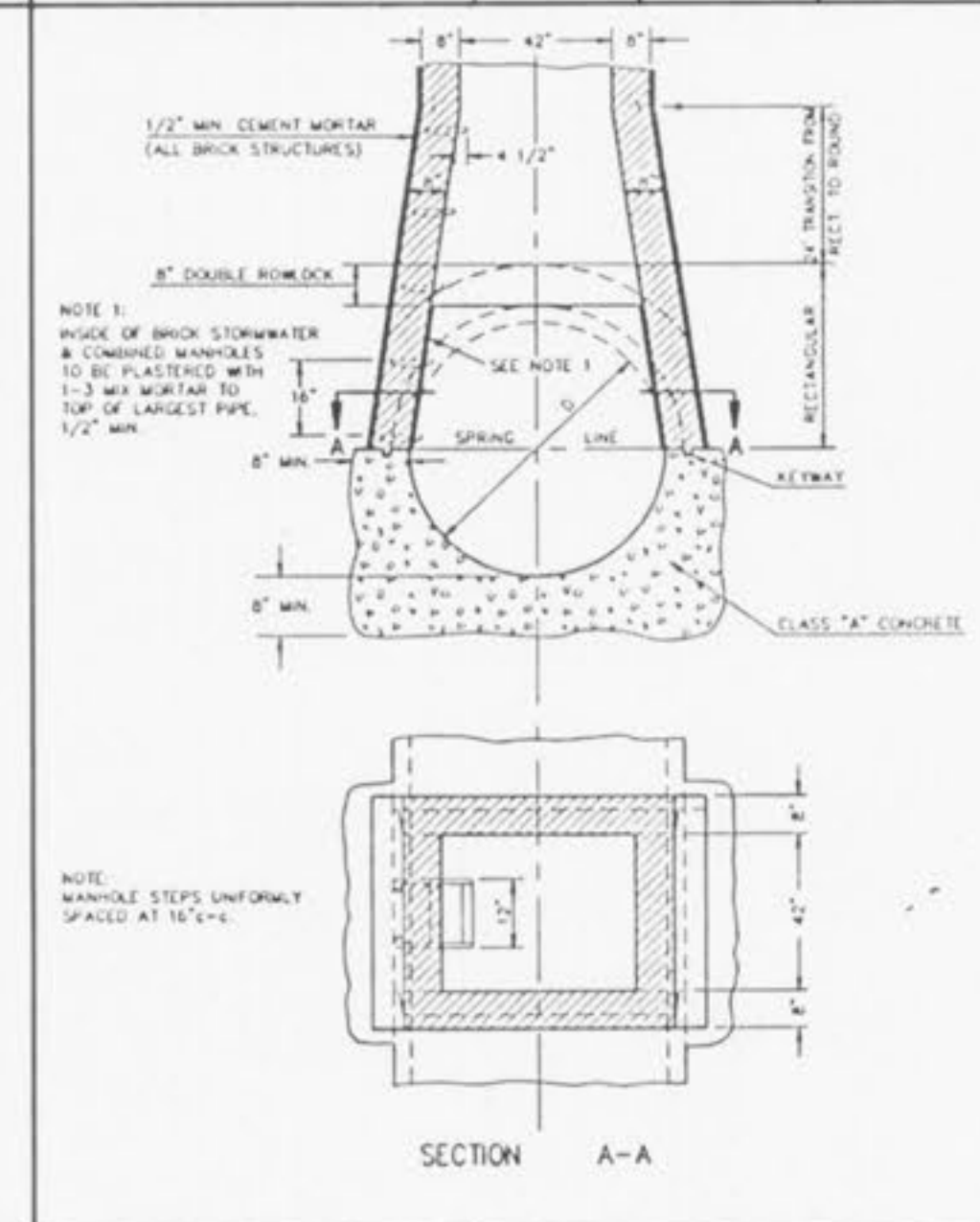
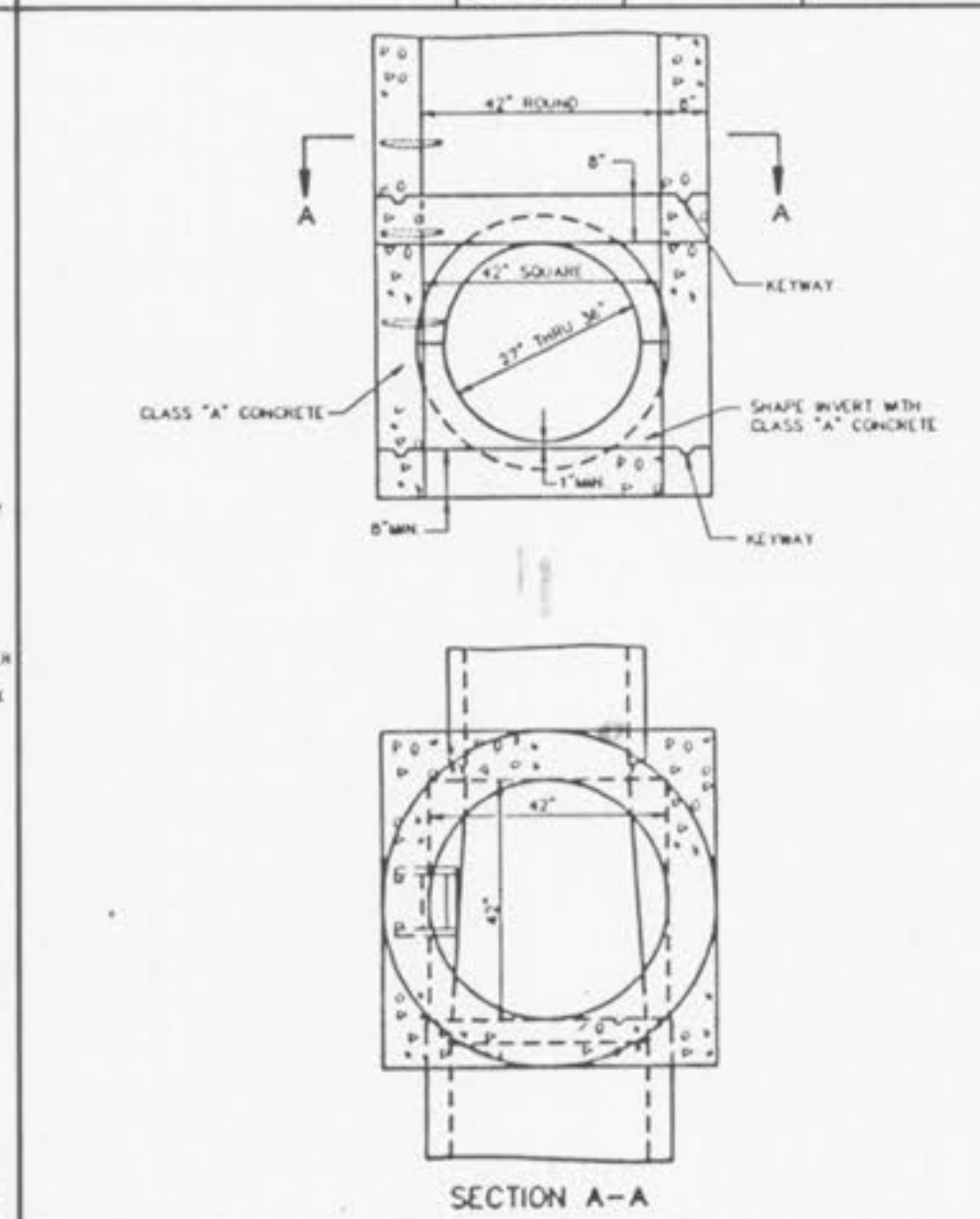
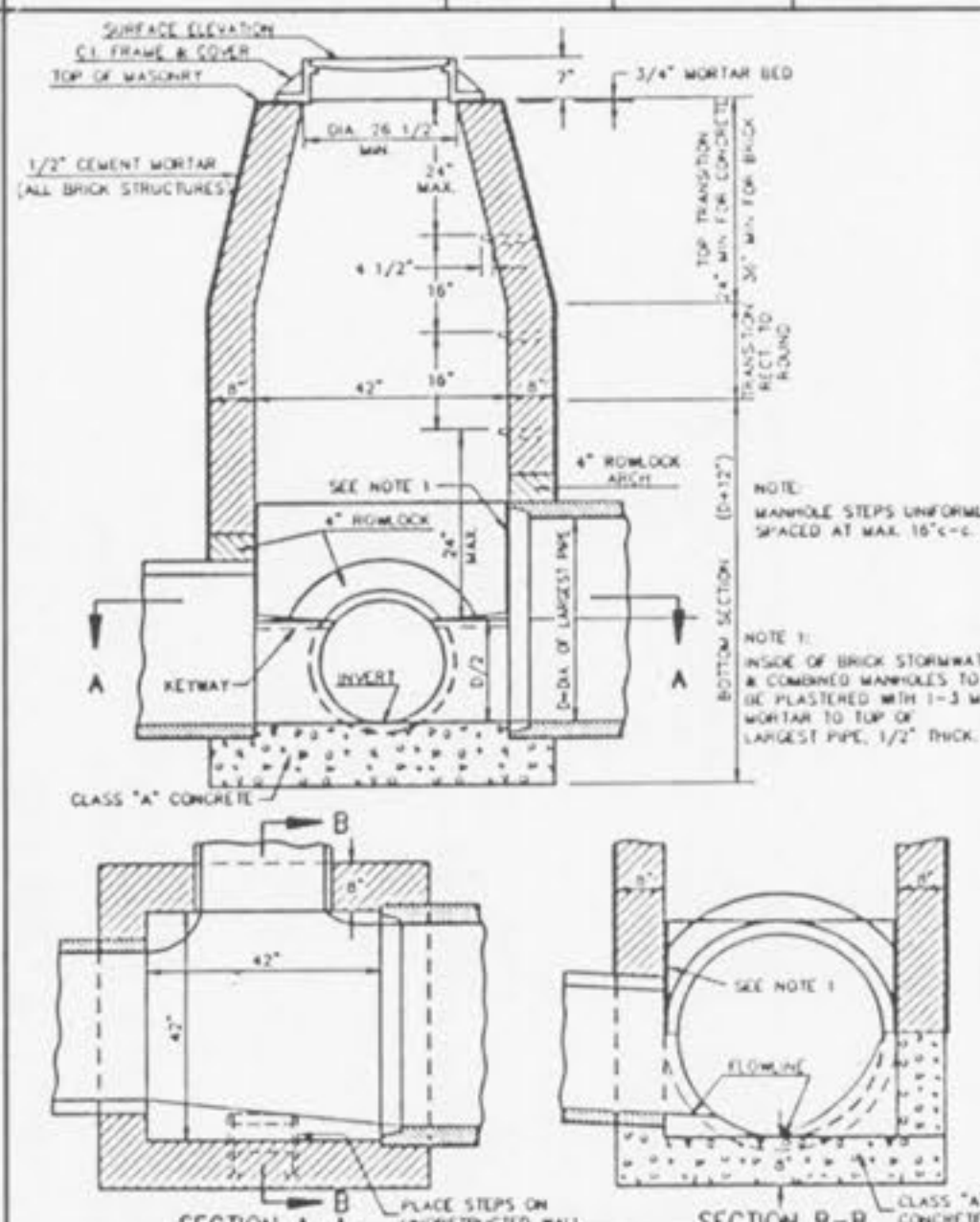
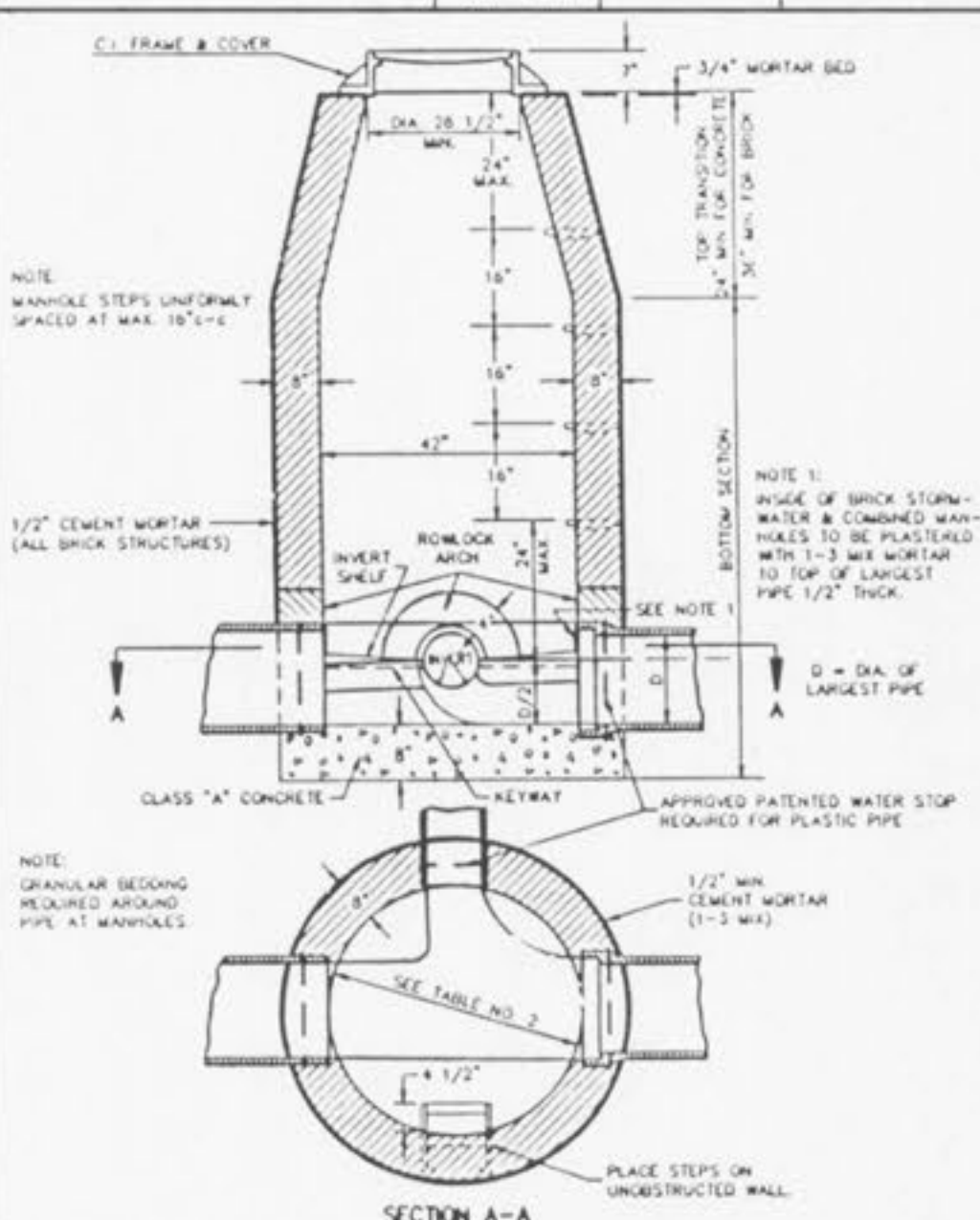
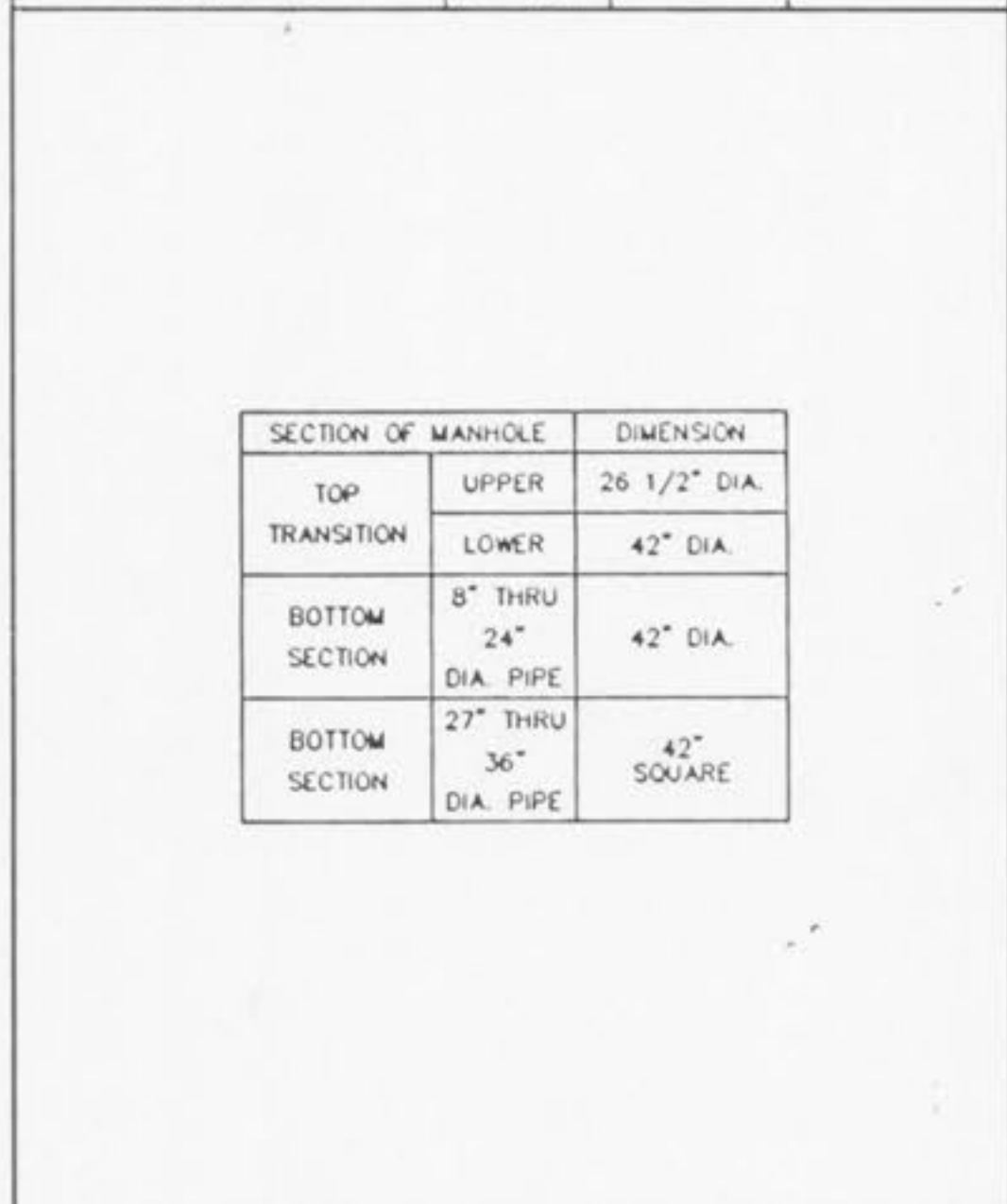

TABLE NO. 2  
STANDARD MANHOLE DIMENSIONS

METROPOLITAN ST. LOUIS SEWER DISTRICT  
Standard Details of Sewer Construction

METROPOLITAN ST. LOUIS SEWER DISTRICT  
Standard Details of Sewer Construction

METROPOLITAN ST. LOUIS SEWER DISTRICT  
Standard Details of Sewer Construction

METROPOLITAN ST. LOUIS SEWER DISTRICT  
Standard Details of Sewer Construction

METROPOLITAN ST. LOUIS SEWER DISTRICT  
Standard Details of Sewer Construction

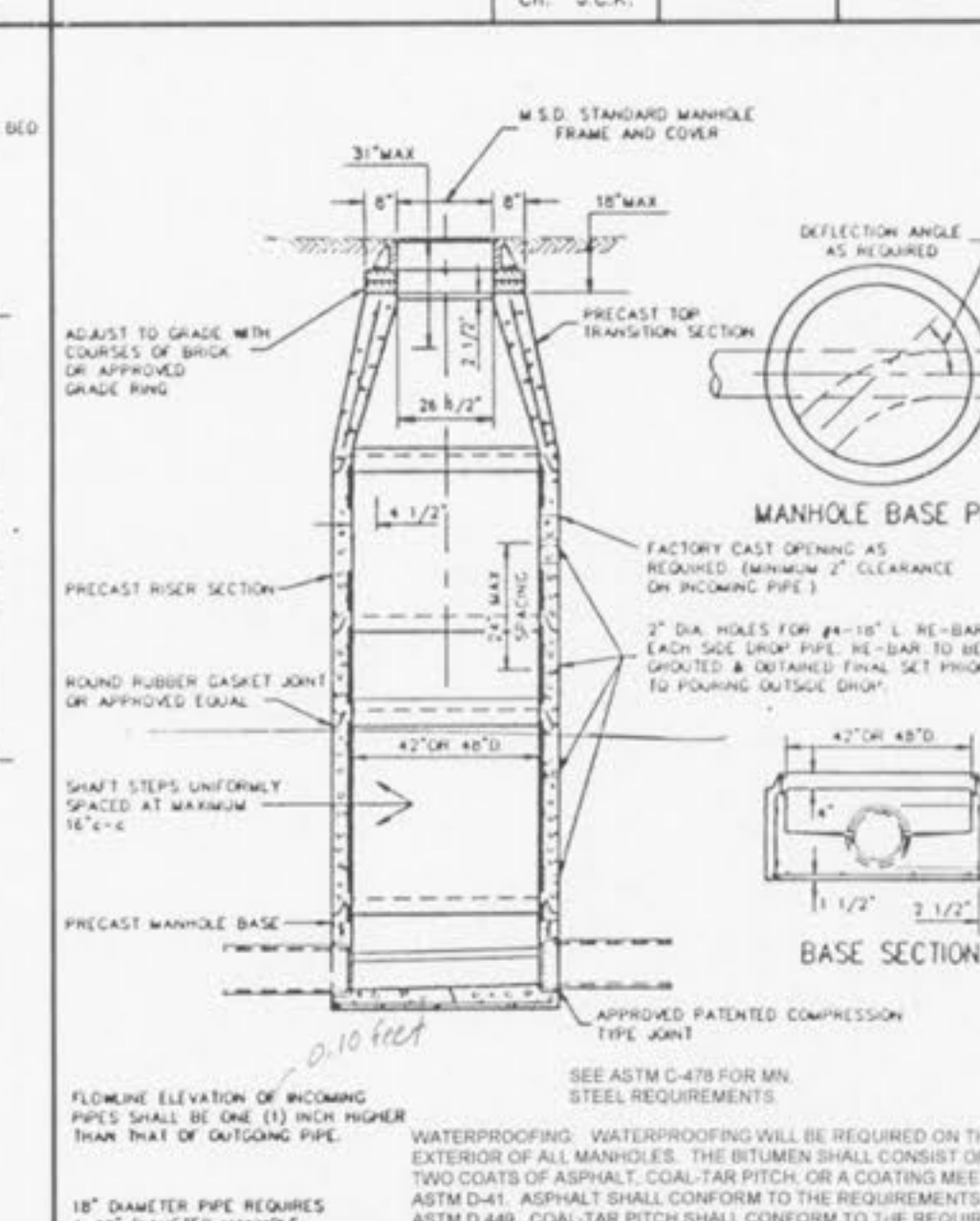
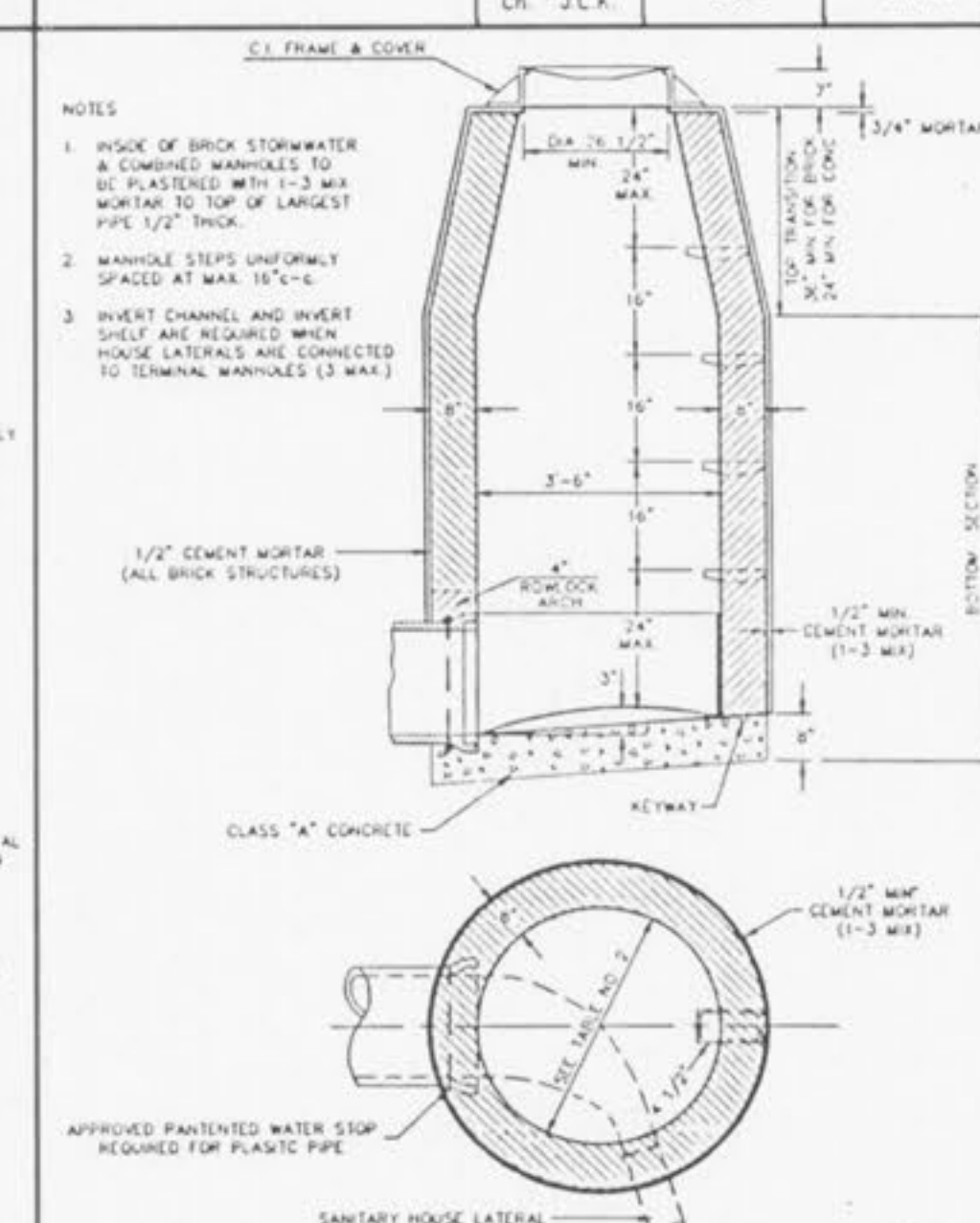
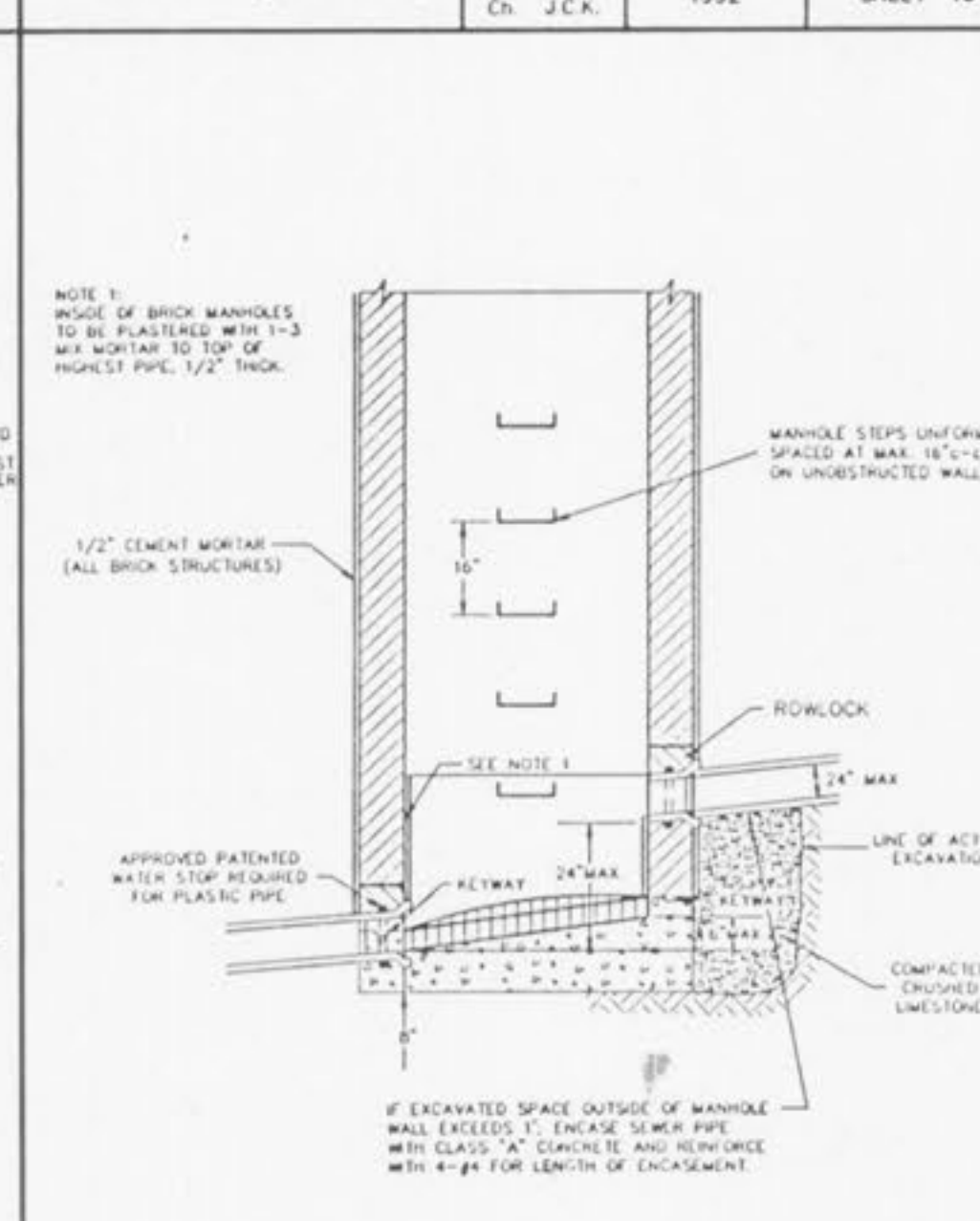
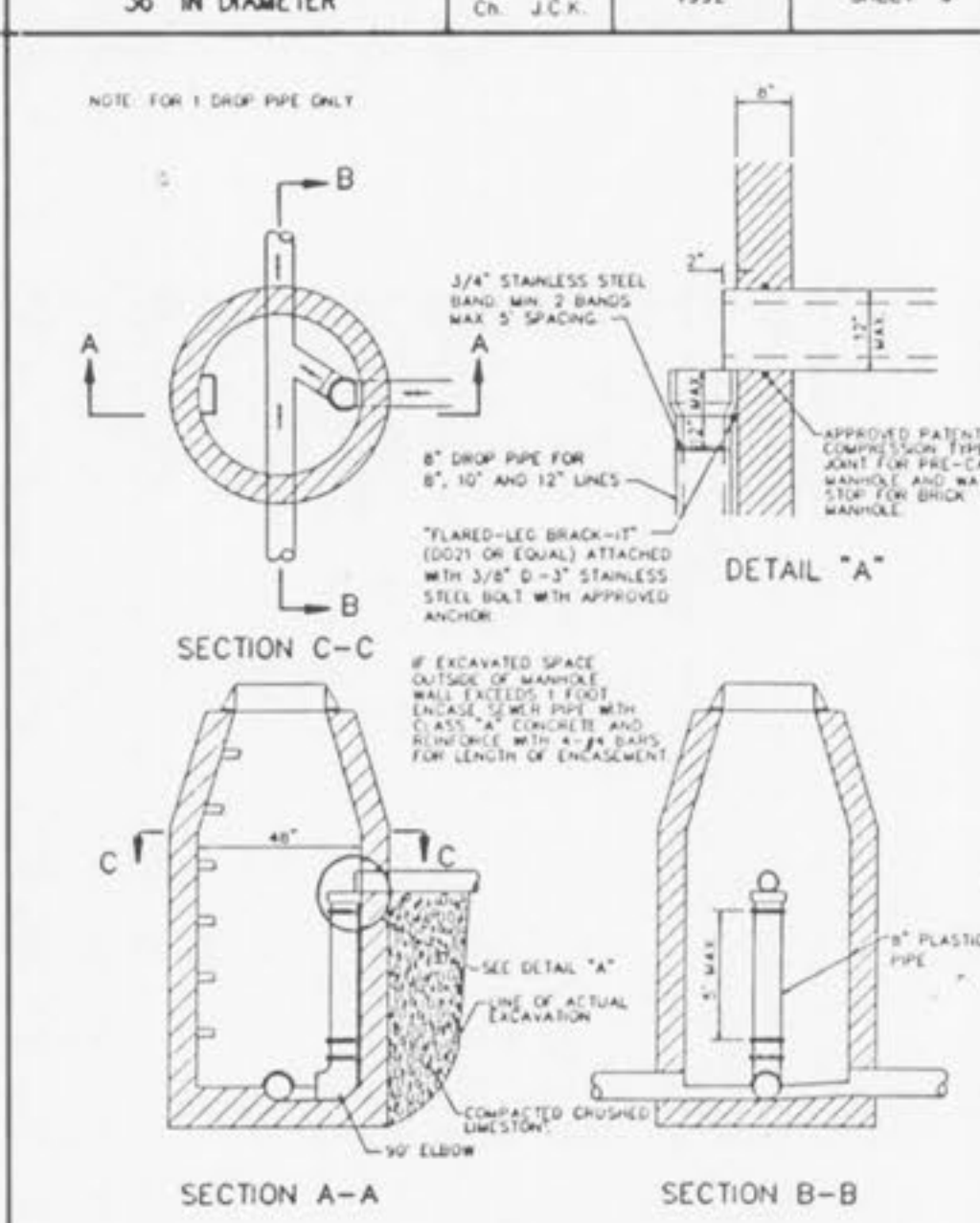
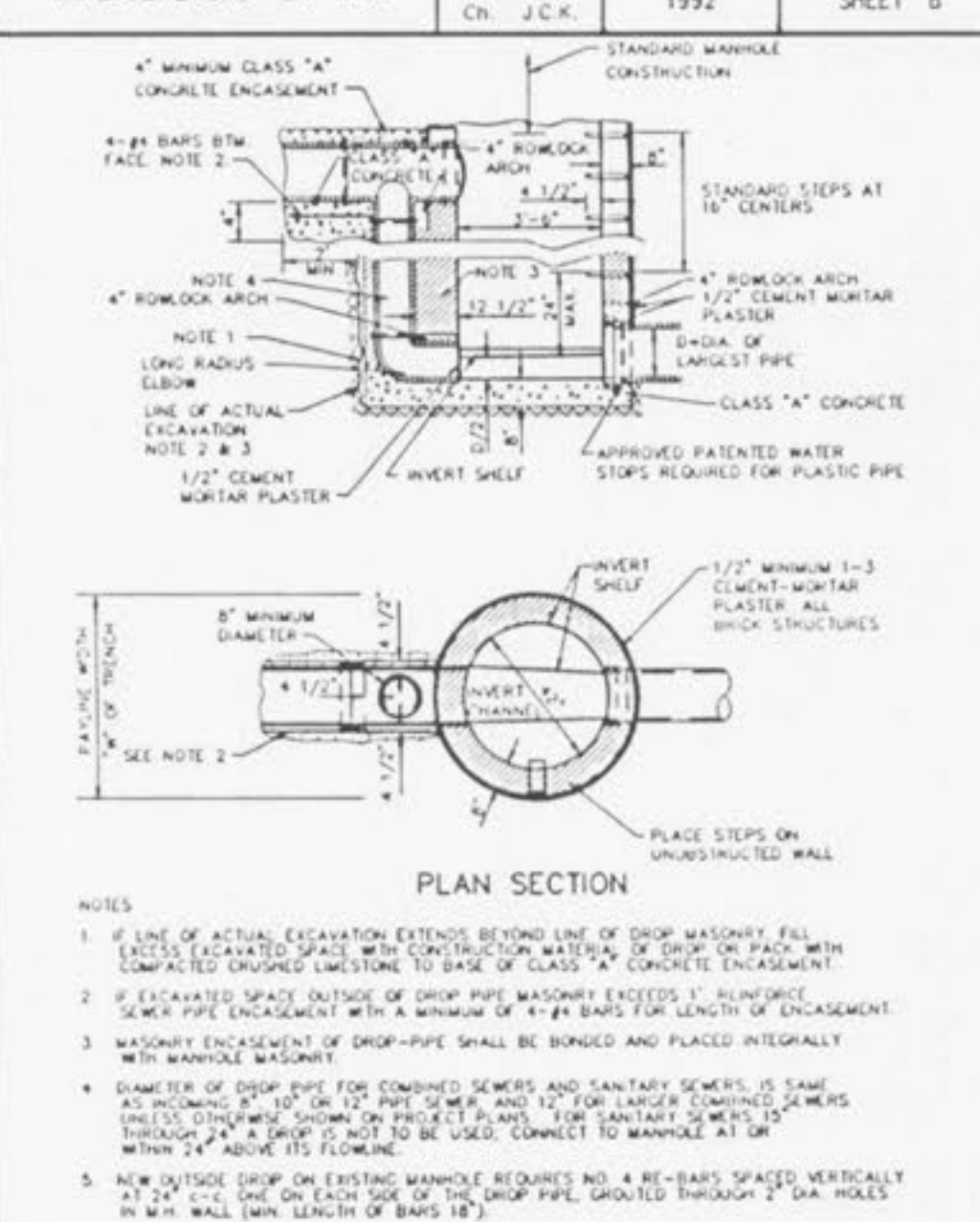
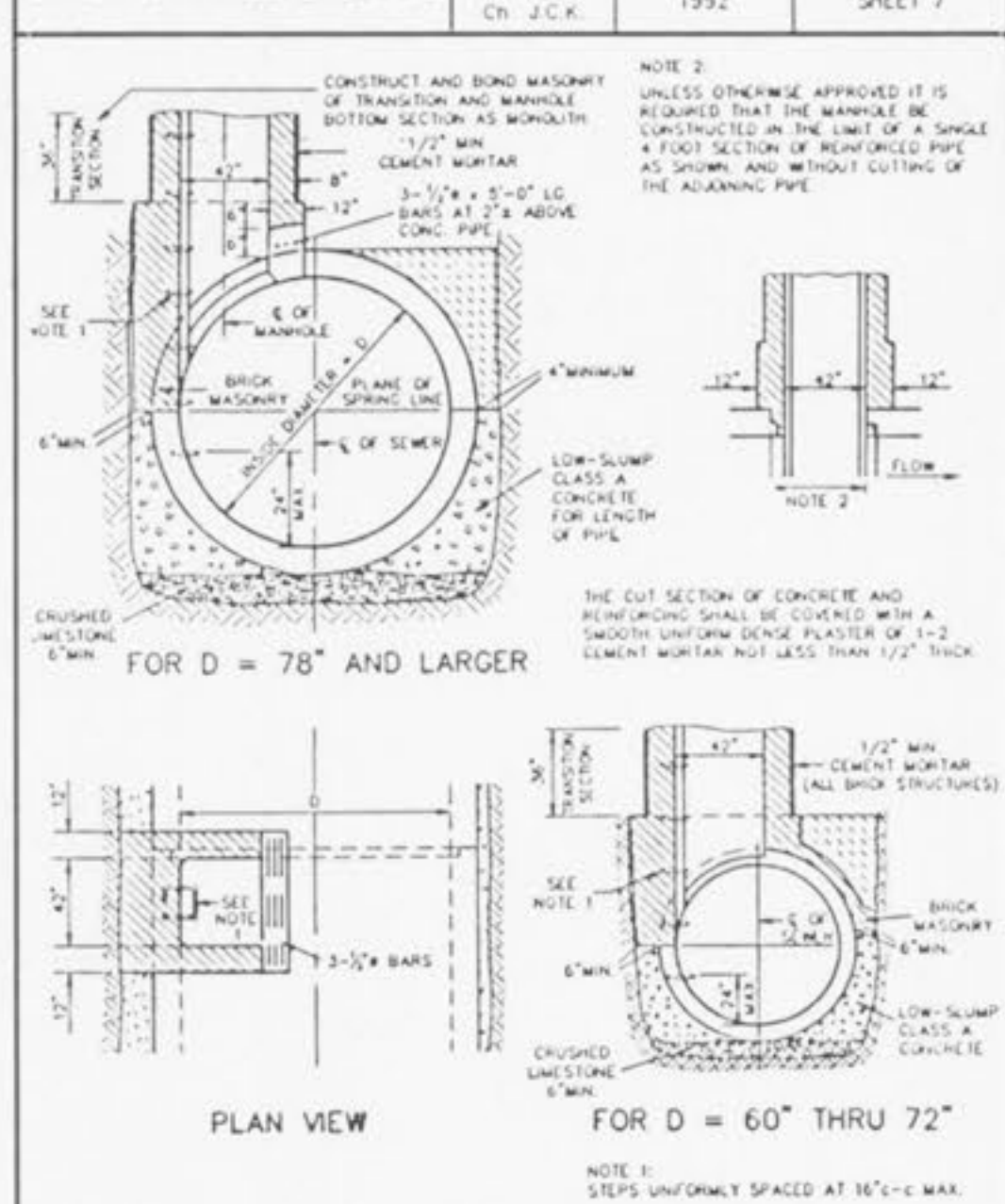

METROPOLITAN ST. LOUIS SEWER DISTRICT  
Standard Details of Sewer Construction

METROPOLITAN ST. LOUIS SEWER DISTRICT  
Standard Details of Sewer Construction

METROPOLITAN ST. LOUIS SEWER DISTRICT  
Standard Details of Sewer Construction

METROPOLITAN ST. LOUIS SEWER DISTRICT  
Standard Details of Sewer Construction

METROPOLITAN ST. LOUIS SEWER DISTRICT  
Standard Details of Sewer Construction

METROPOLITAN ST. LOUIS SEWER DISTRICT  
Standard Details of Sewer Construction