

INSIDE FOULWATER DROP MANHOLE  
 METROPOLITAN ST. LOUIS SEWER DISTRICT  
 Standard Details of Sewer Construction  
 1992 SHEET 15

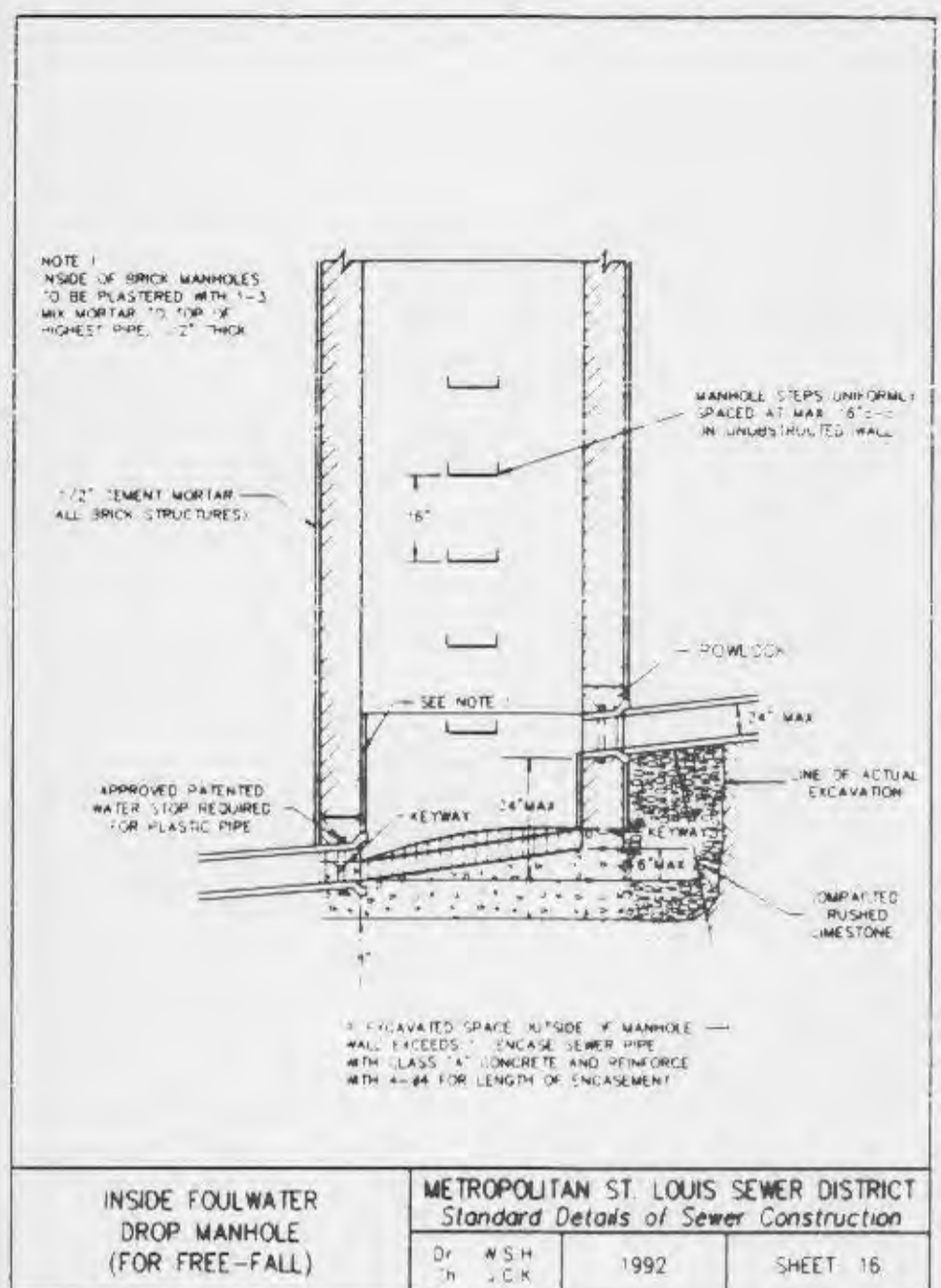

INSIDE FOULWATER DROP MANHOLE (FOR FREE-FALL)  
 METROPOLITAN ST. LOUIS SEWER DISTRICT  
 Standard Details of Sewer Construction  
 1992 SHEET 16

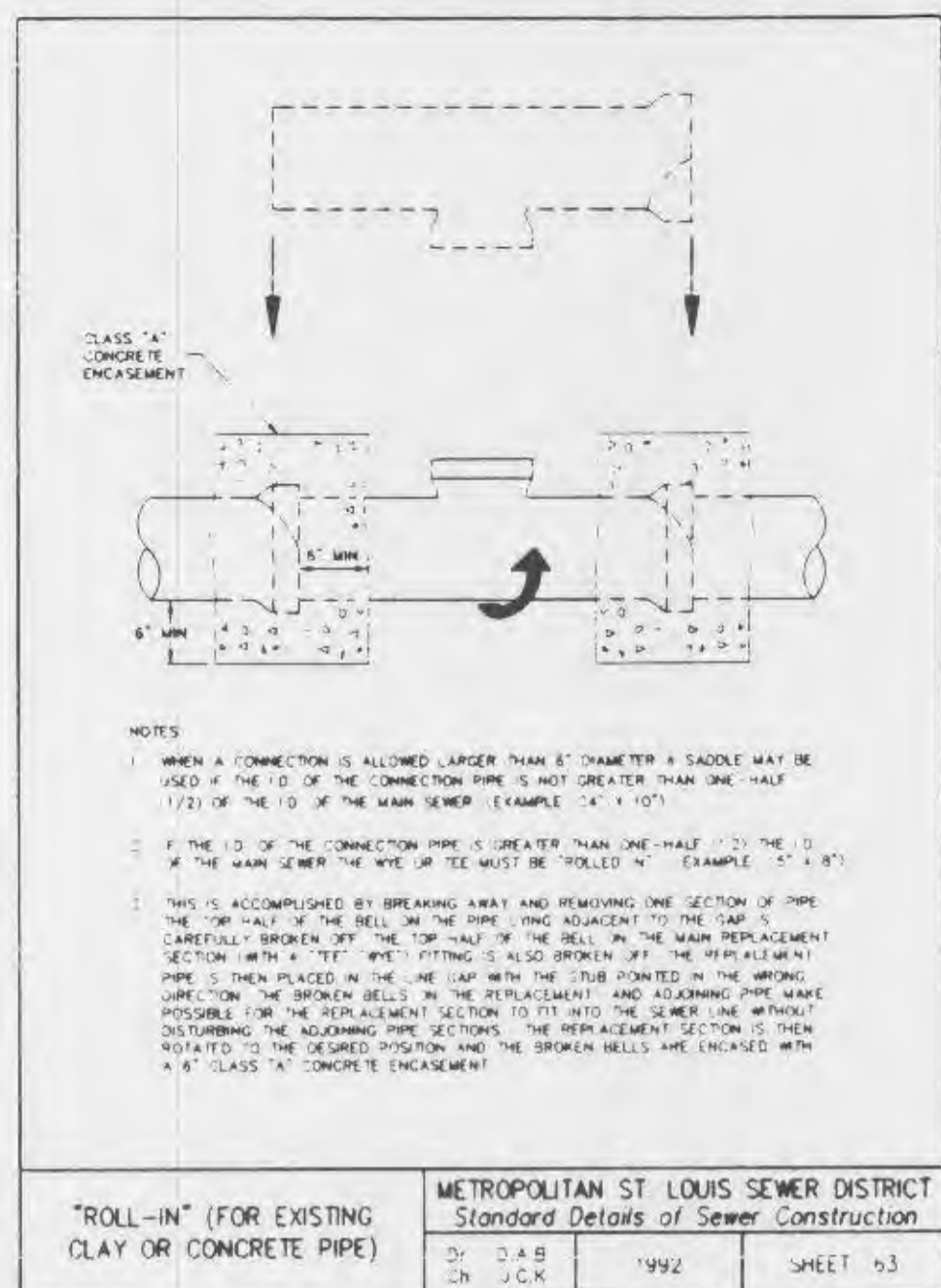

"ROLL-IN" (FOR EXISTING CLAY OR CONCRETE PIPE)  
 METROPOLITAN ST. LOUIS SEWER DISTRICT  
 Standard Details of Sewer Construction  
 1992 SHEET 13

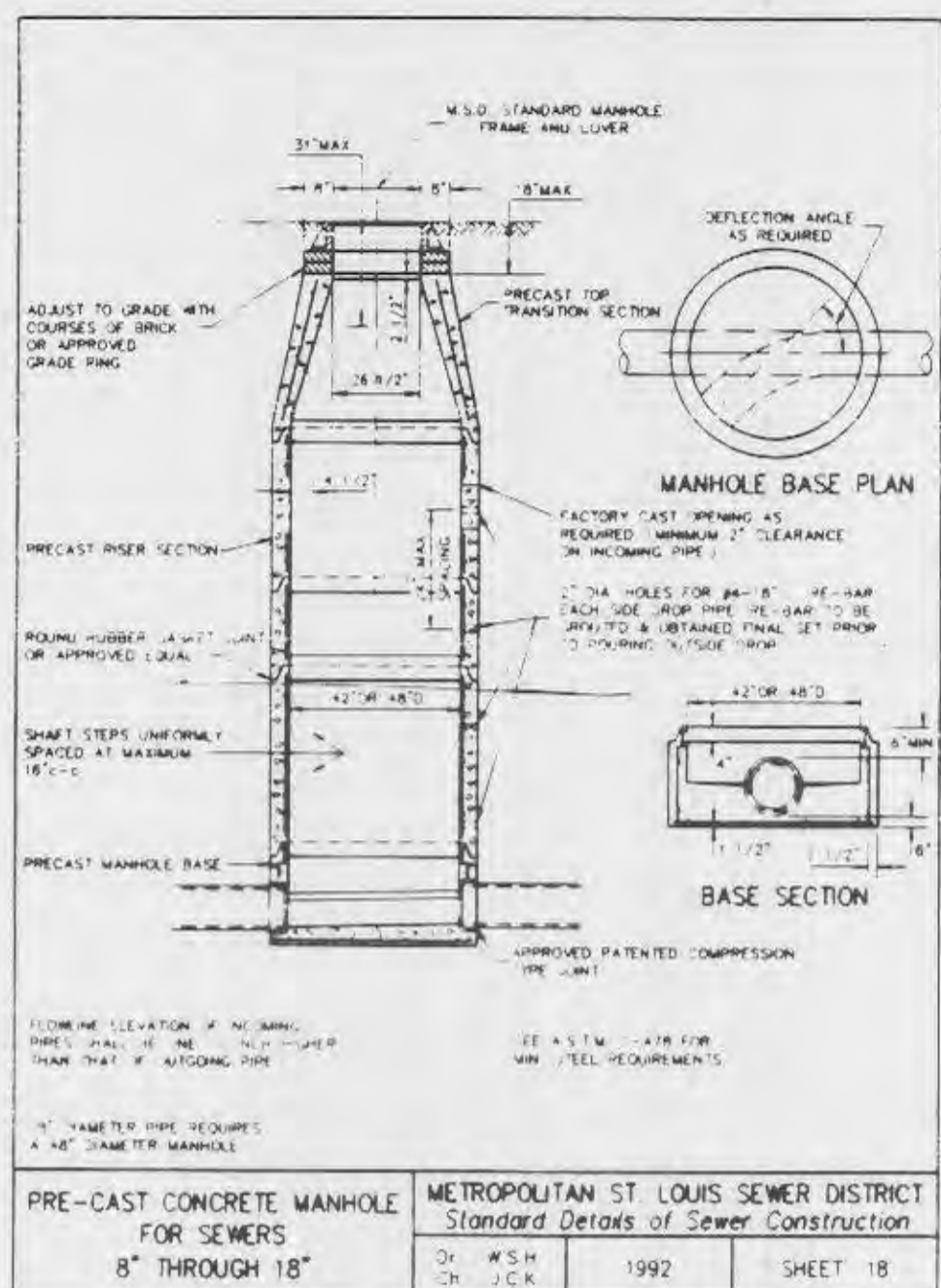

PRE-CAST CONCRETE MANHOLE FOR SEWERS 8\"/>
 METROPOLITAN ST. LOUIS SEWER DISTRICT  
 Standard Details of Sewer Construction  
 1992 SHEET 18

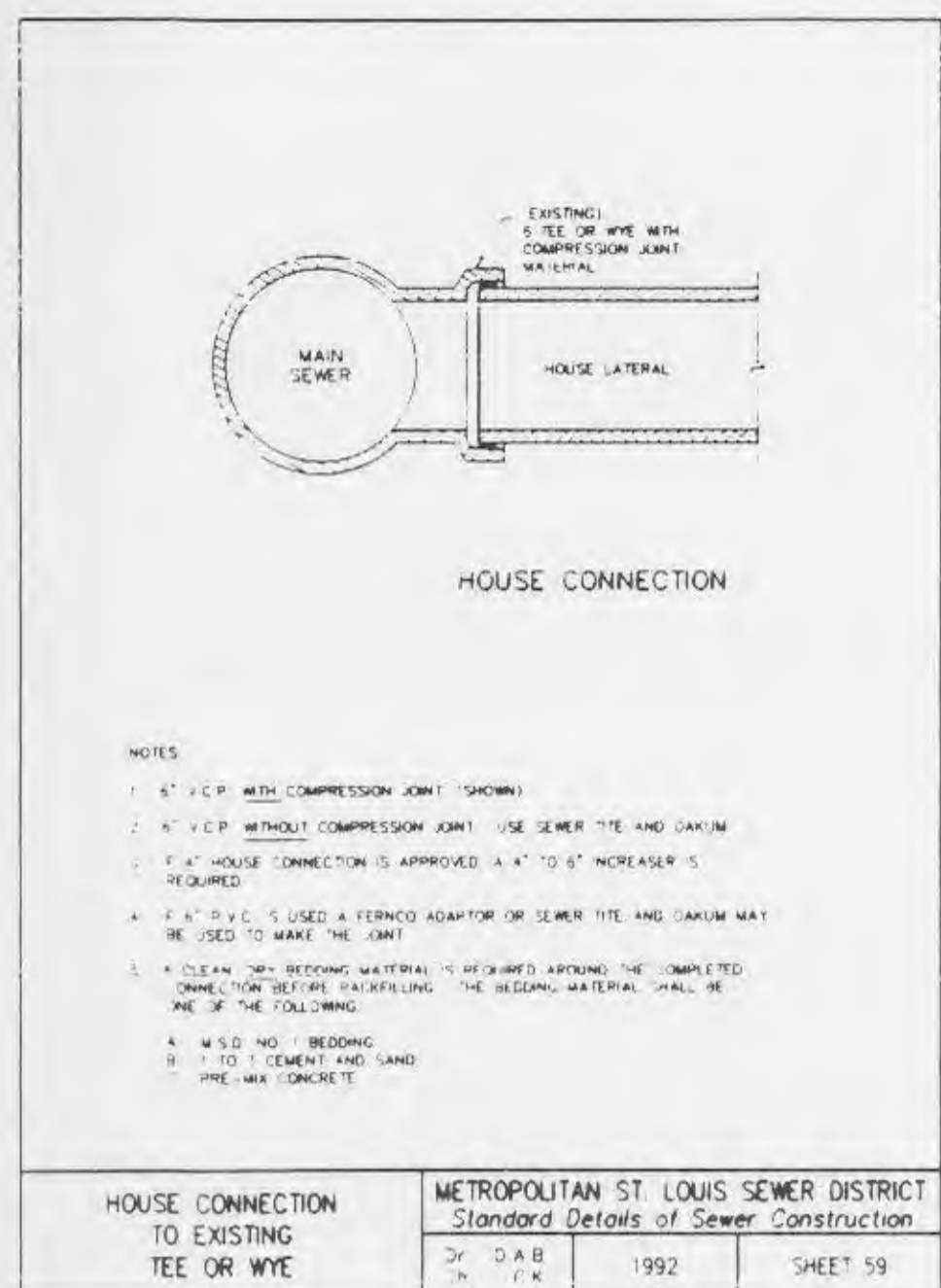

HOUSE CONNECTION TO EXISTING TEE OR WYE  
 METROPOLITAN ST. LOUIS SEWER DISTRICT  
 Standard Details of Sewer Construction  
 1992 SHEET 59

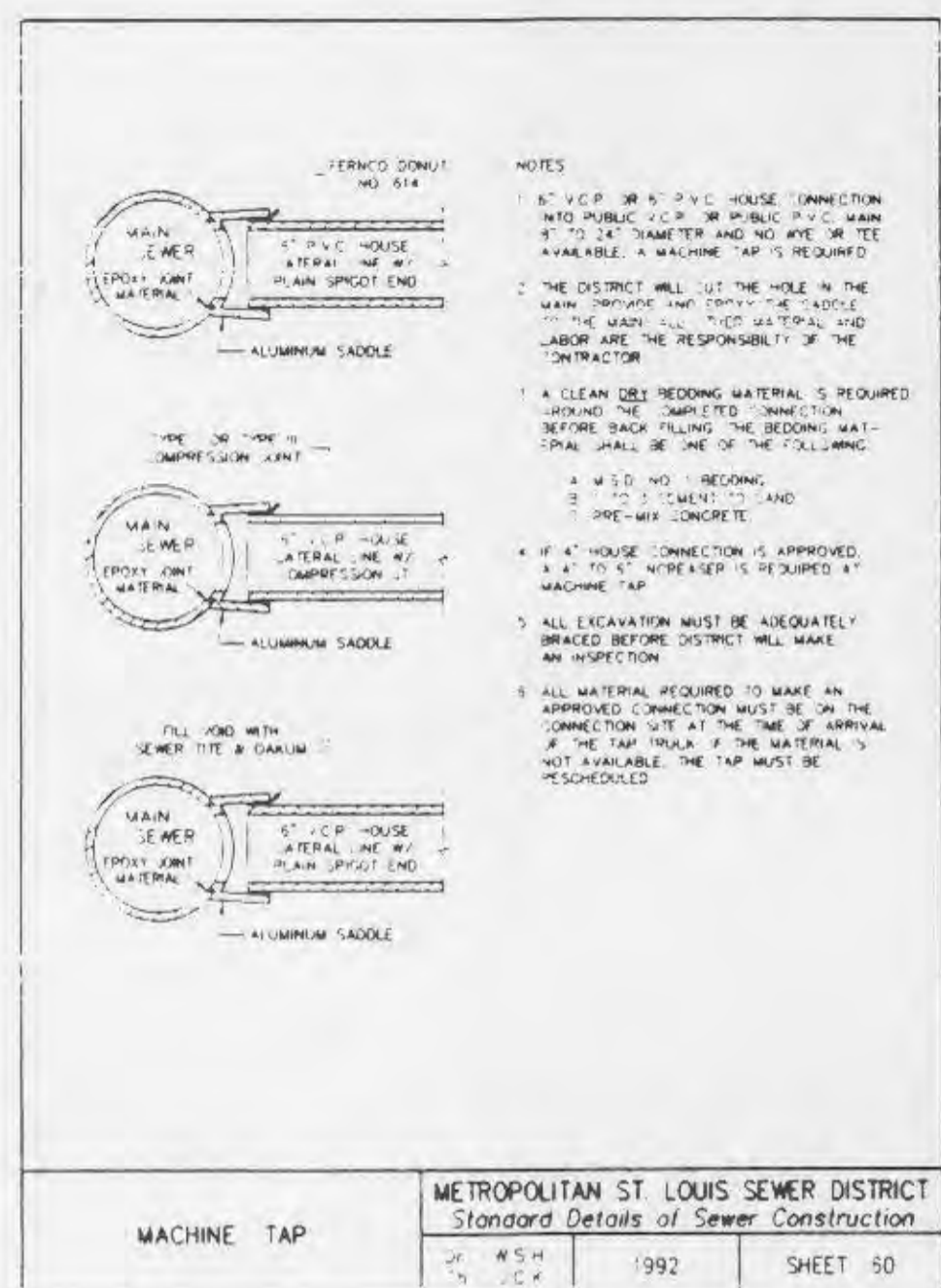

MACHINE TAP  
 METROPOLITAN ST. LOUIS SEWER DISTRICT  
 Standard Details of Sewer Construction  
 1992 SHEET 50

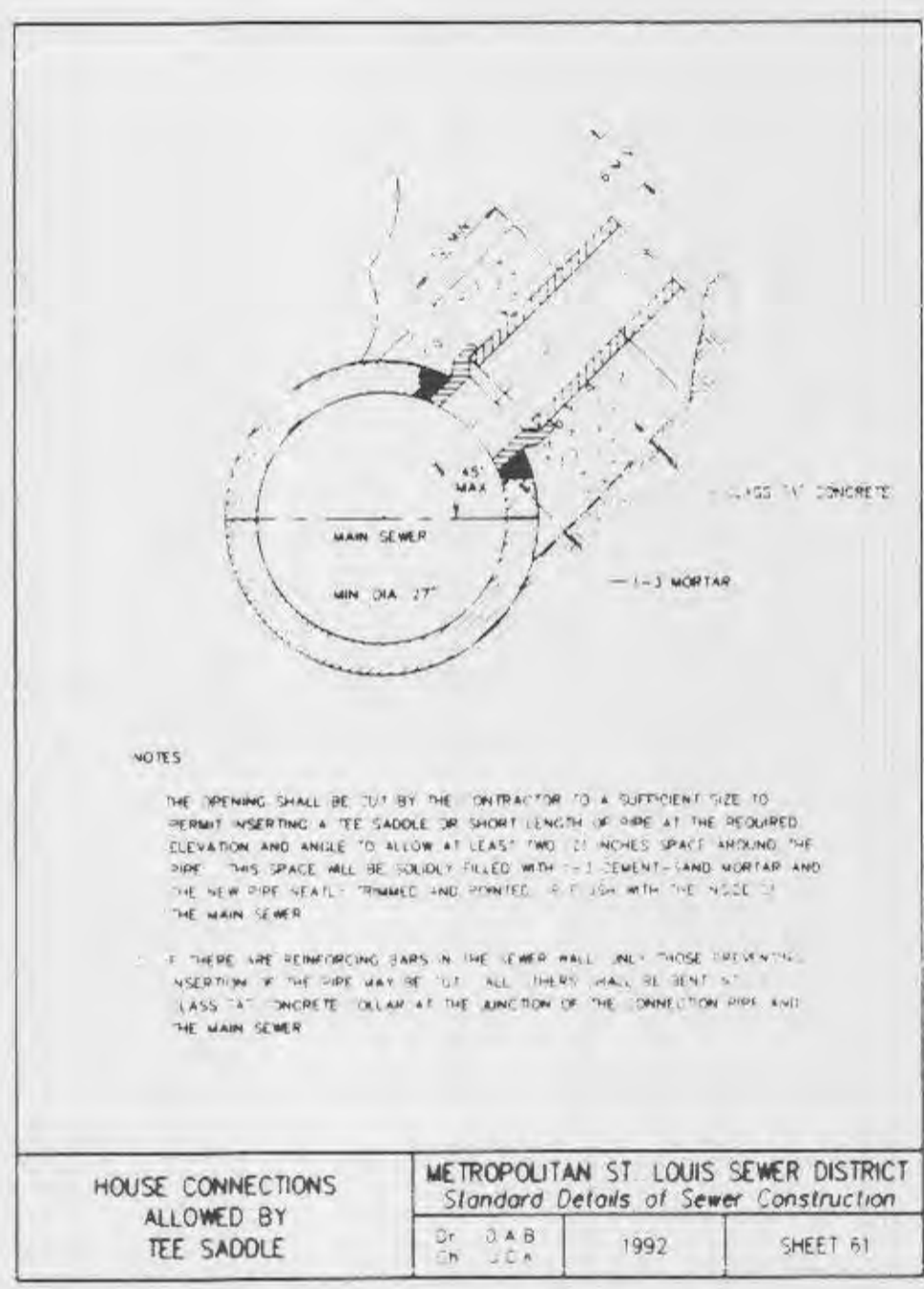

HOUSE CONNECTIONS ALLOWED BY TEE SADDLE  
 METROPOLITAN ST. LOUIS SEWER DISTRICT  
 Standard Details of Sewer Construction  
 1992 SHEET 61

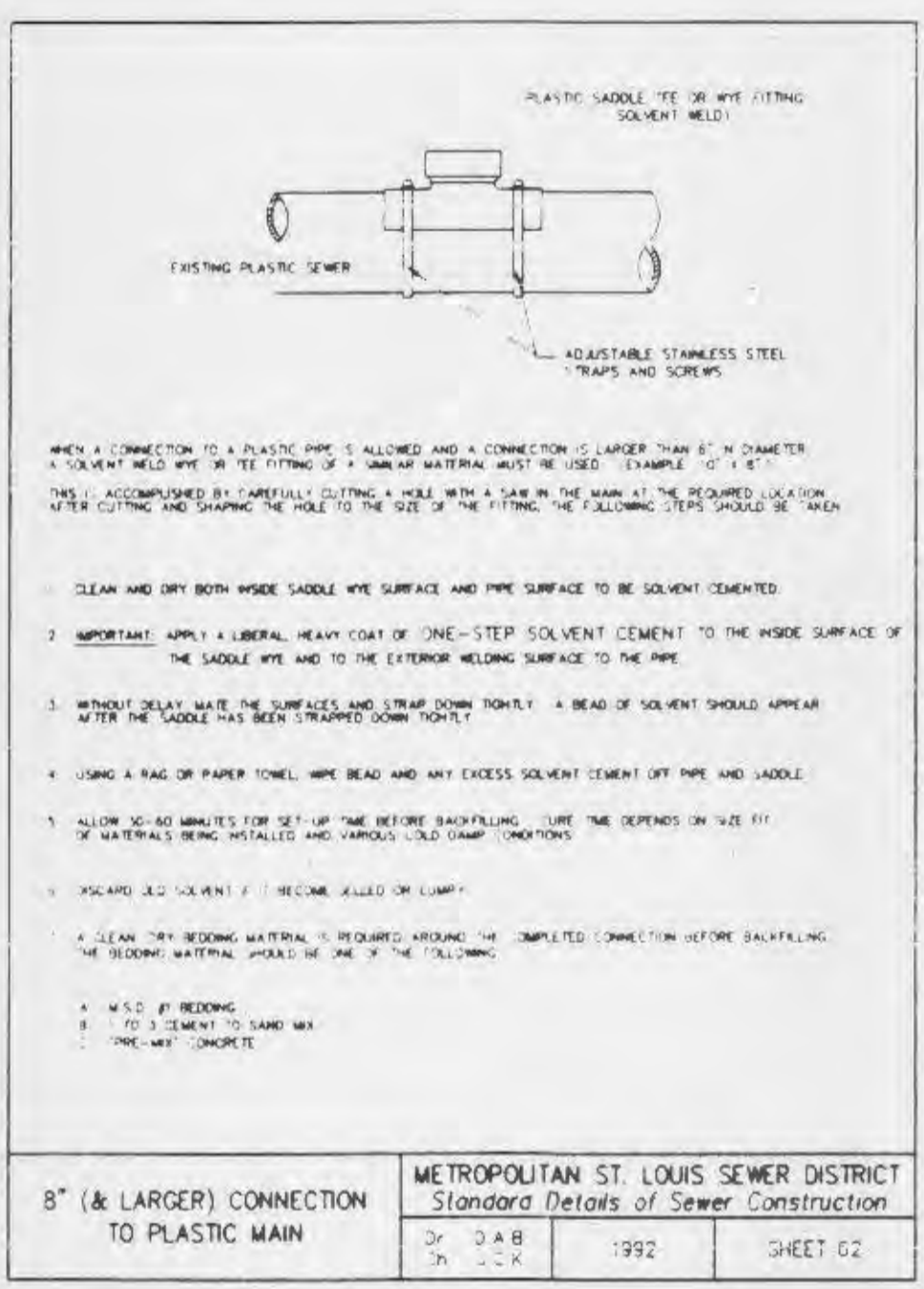

8\"/>
 METROPOLITAN ST. LOUIS SEWER DISTRICT  
 Standard Details of Sewer Construction  
 1992 SHEET 62

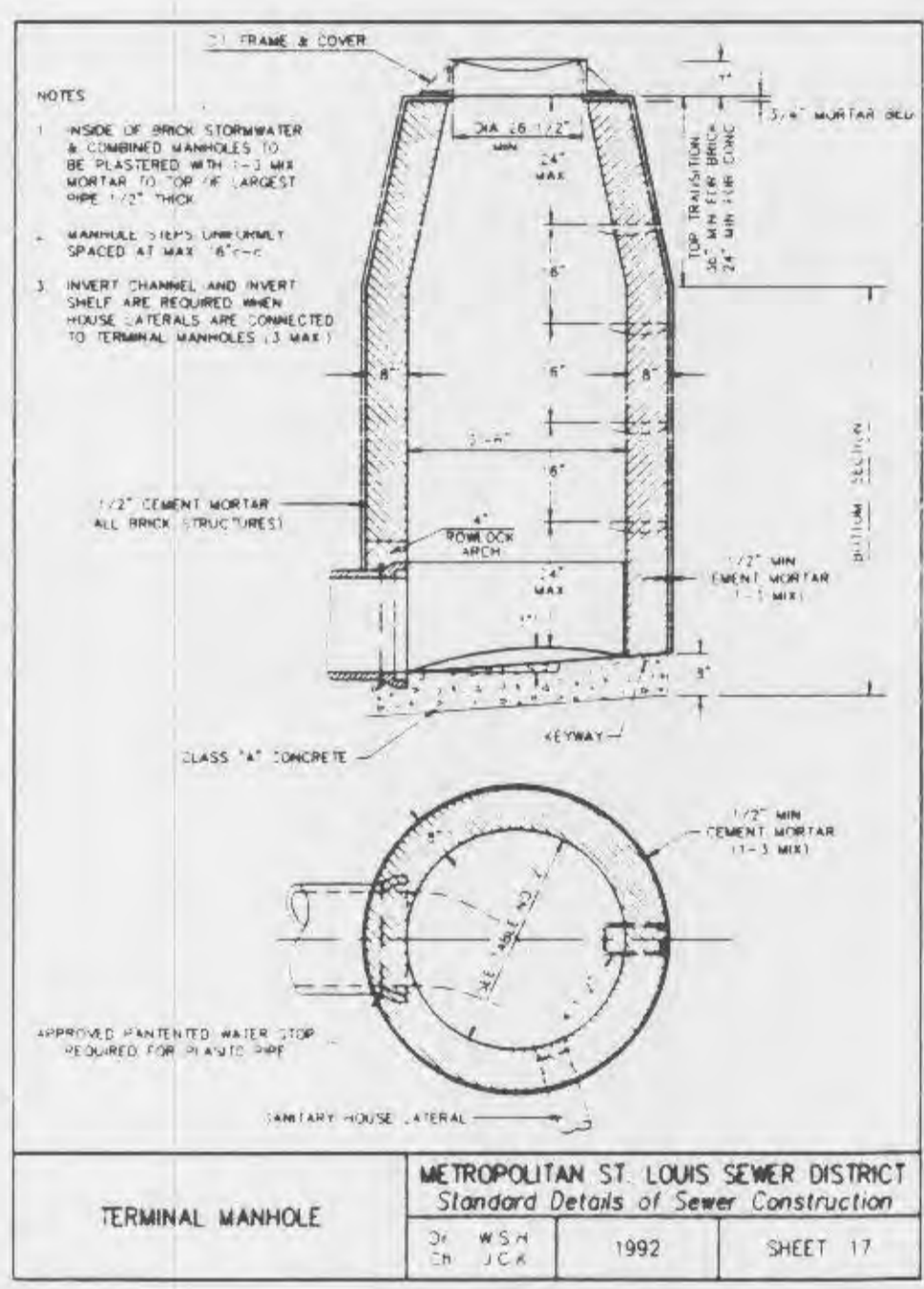

TERMINAL MANHOLE  
 METROPOLITAN ST. LOUIS SEWER DISTRICT  
 Standard Details of Sewer Construction  
 1992 SHEET 17

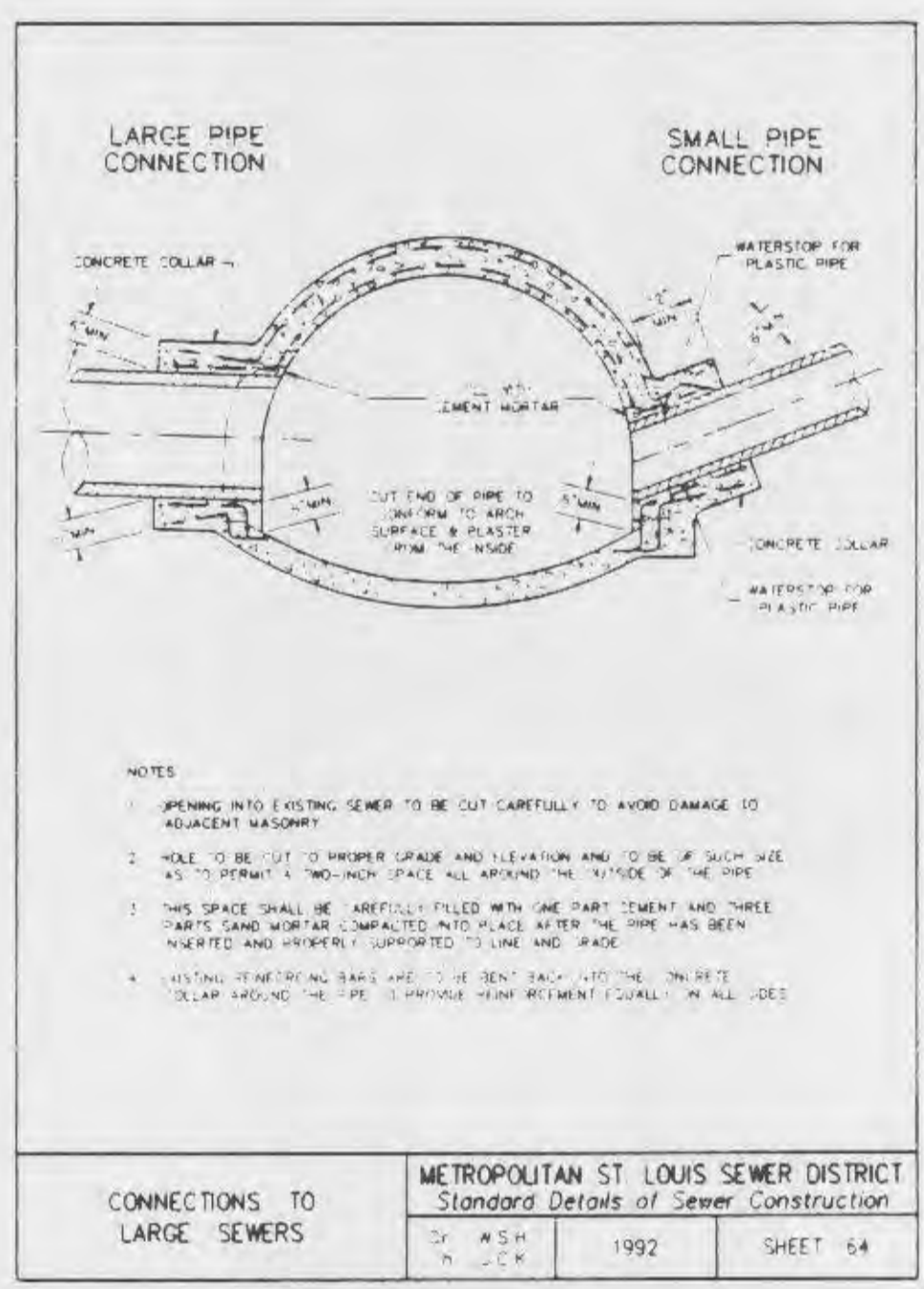

CONNECTIONS TO LARGE SEWERS  
 METROPOLITAN ST. LOUIS SEWER DISTRICT  
 Standard Details of Sewer Construction  
 1992 SHEET 64

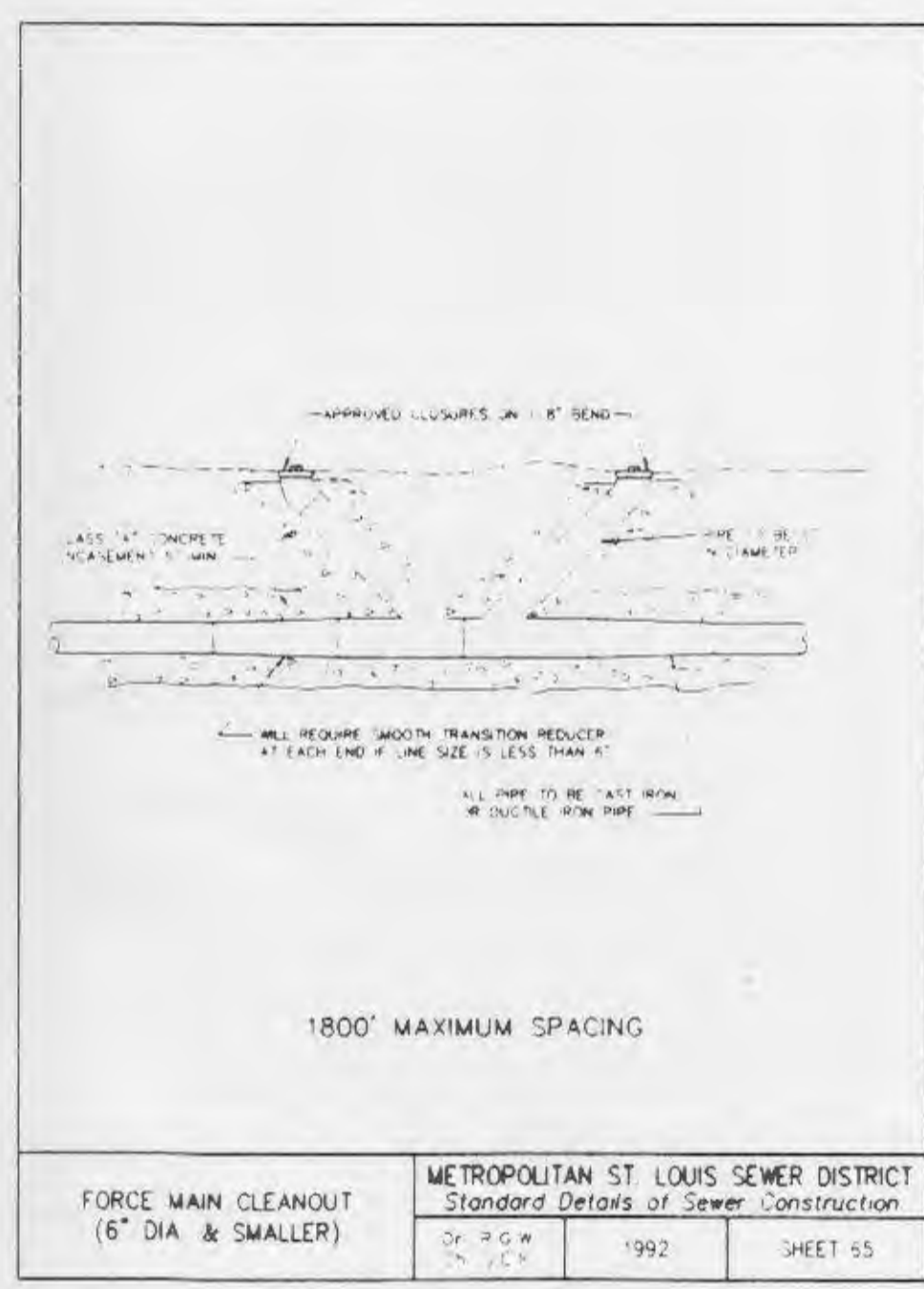

FORCE MAIN CLEANOUT (6\"/>
 METROPOLITAN ST. LOUIS SEWER DISTRICT  
 Standard Details of Sewer Construction  
 1992 SHEET 55

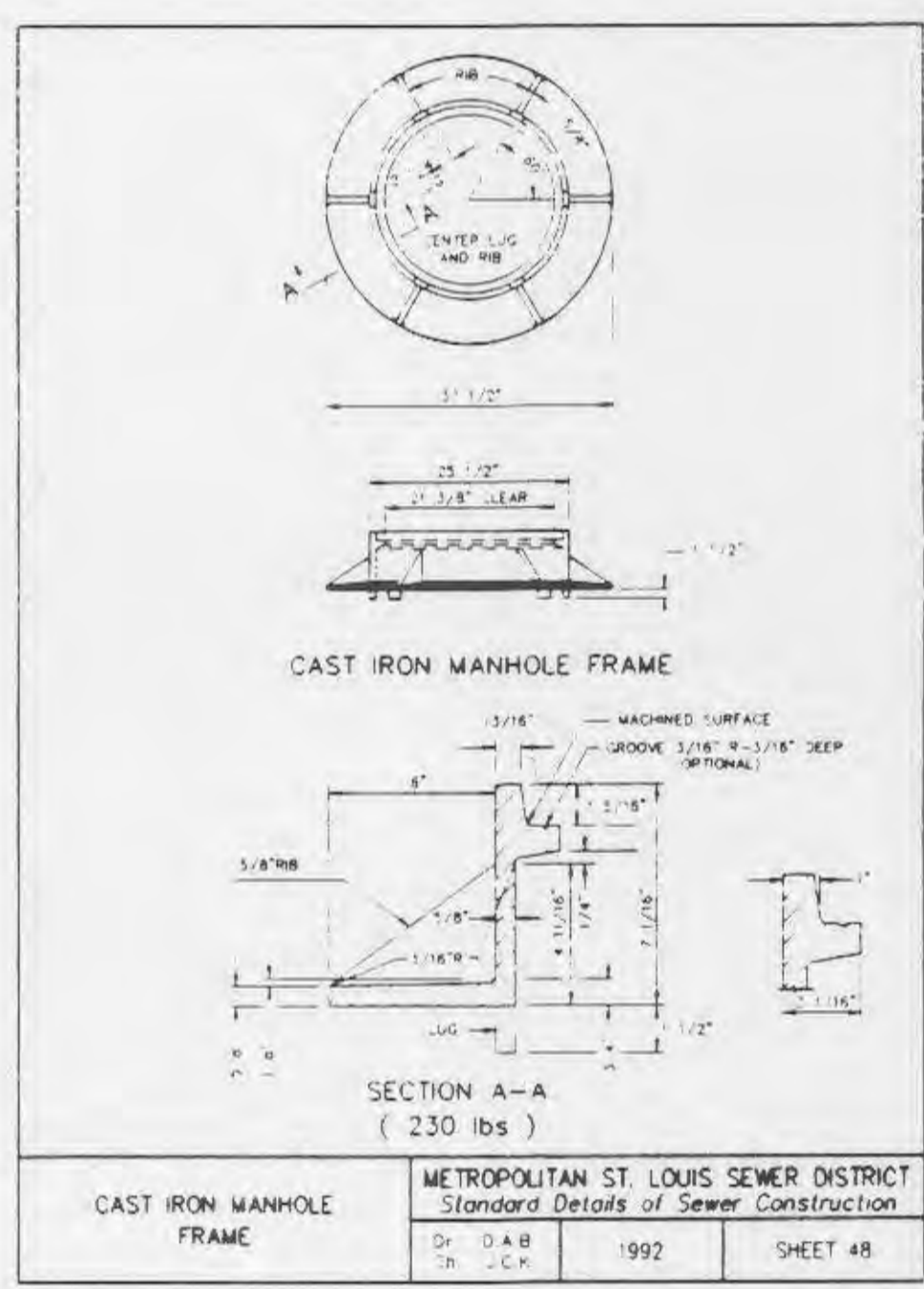

CAST IRON MANHOLE FRAME  
 METROPOLITAN ST. LOUIS SEWER DISTRICT  
 Standard Details of Sewer Construction  
 1992 SHEET 48

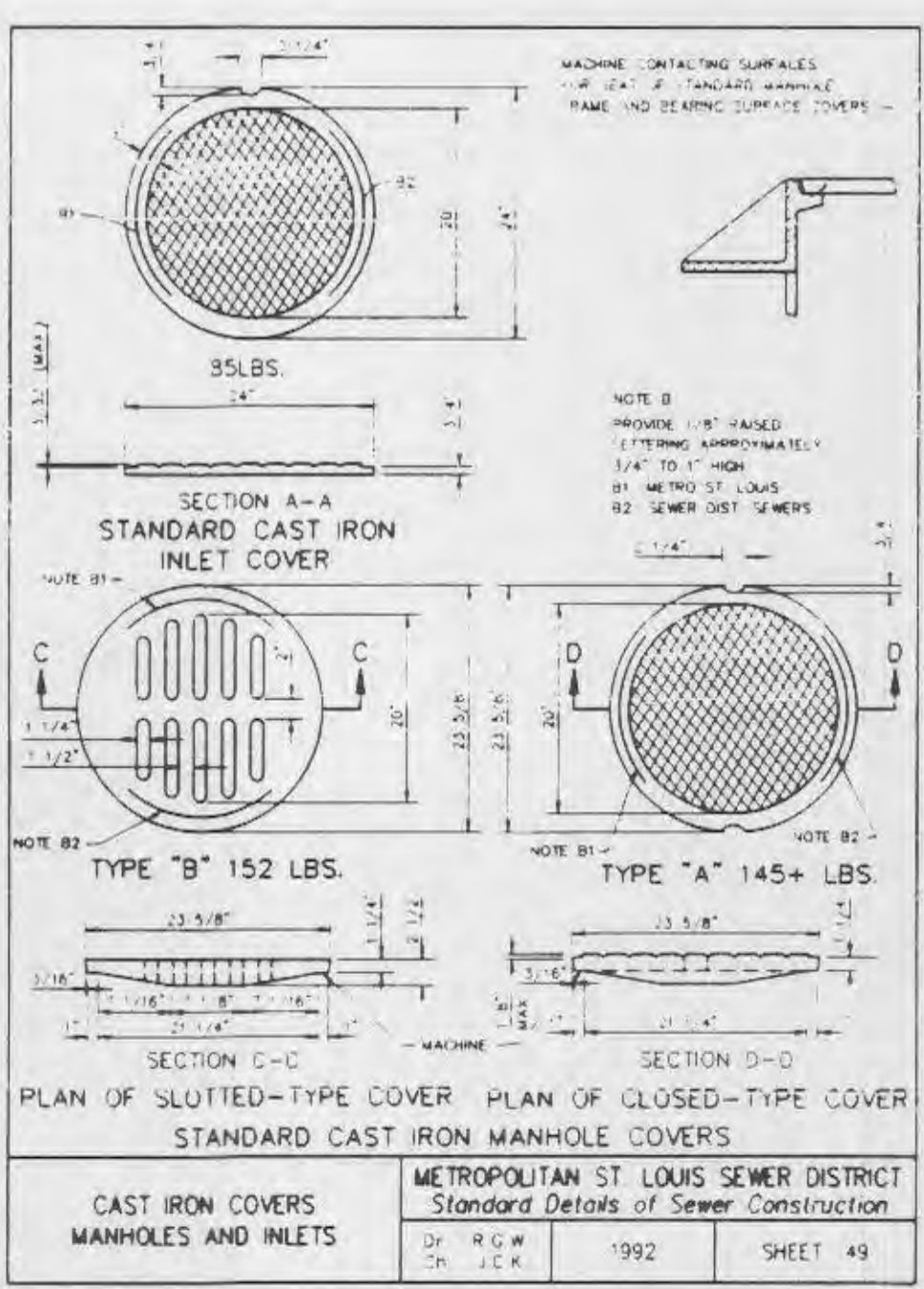

CAST IRON COVERS MANHOLES AND INLETS  
 METROPOLITAN ST. LOUIS SEWER DISTRICT  
 Standard Details of Sewer Construction  
 1992 SHEET 49

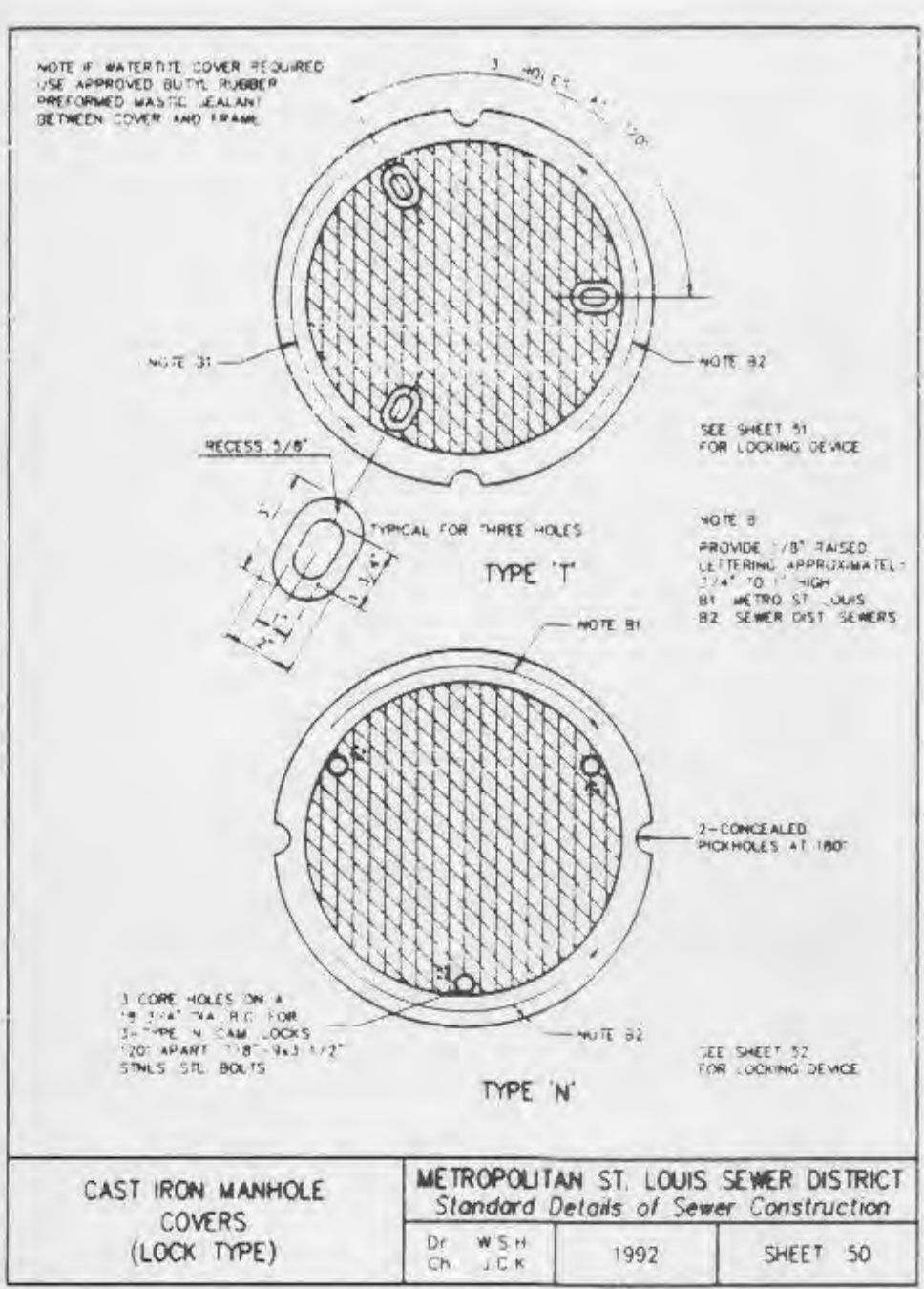

CAST IRON MANHOLE COVERS (LOCK TYPE)  
 METROPOLITAN ST. LOUIS SEWER DISTRICT  
 Standard Details of Sewer Construction  
 1992 SHEET 50

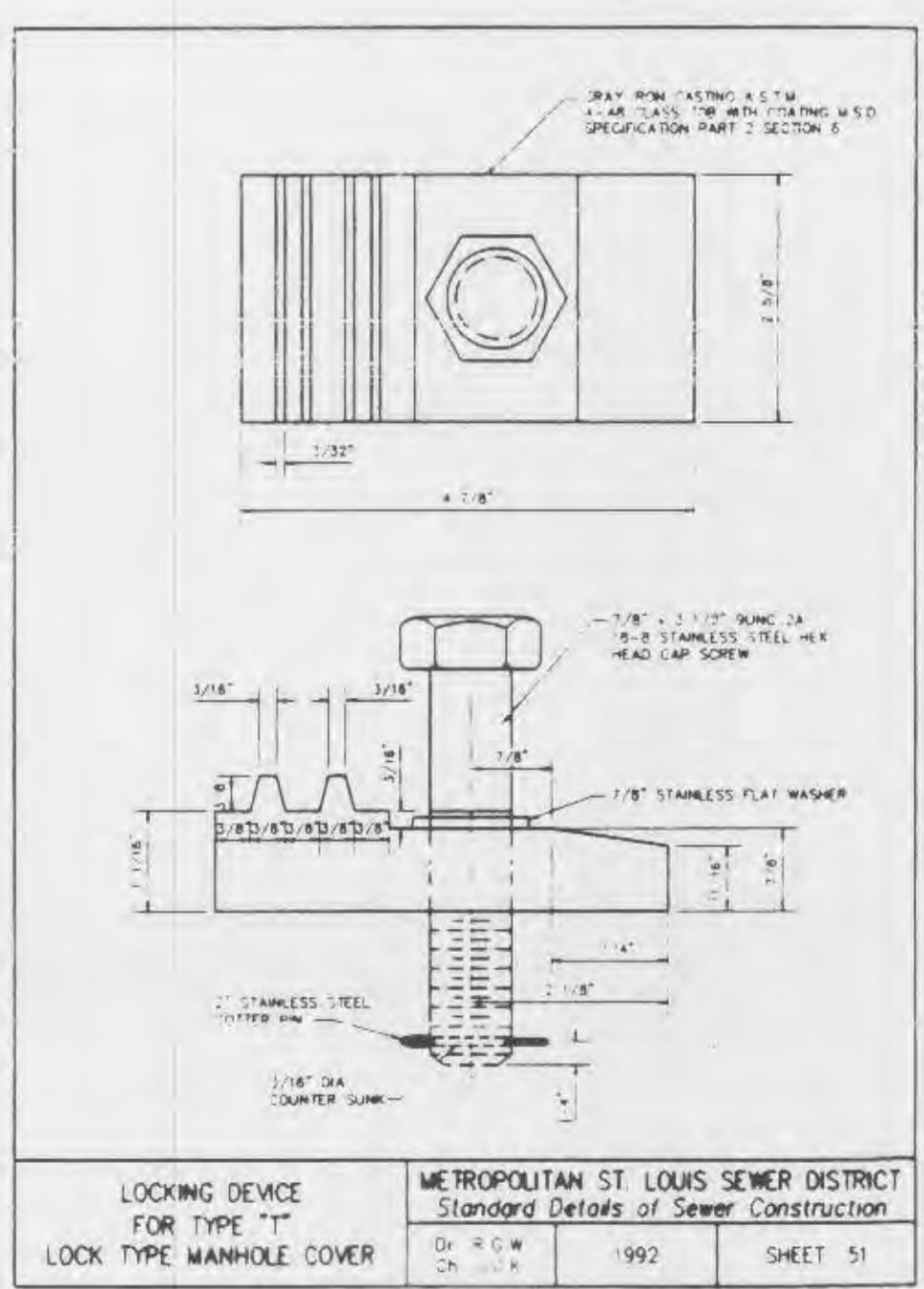

LOCKING DEVICE FOR TYPE 'T' LOCK TYPE MANHOLE COVER  
 METROPOLITAN ST. LOUIS SEWER DISTRICT  
 Standard Details of Sewer Construction  
 1992 SHEET 51

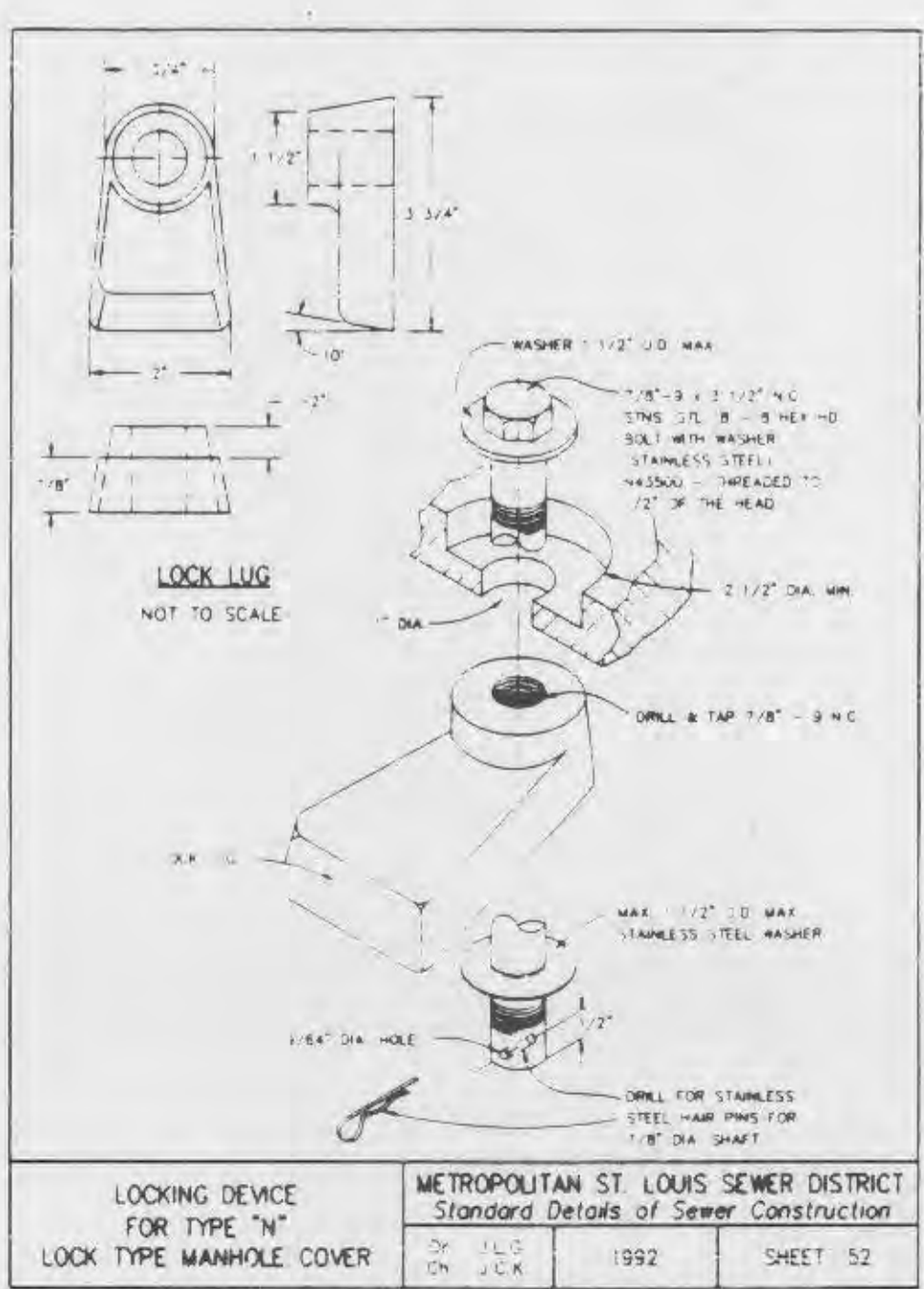

LOCKING DEVICE FOR TYPE 'N' LOCK TYPE MANHOLE COVER  
 METROPOLITAN ST. LOUIS SEWER DISTRICT  
 Standard Details of Sewer Construction  
 1992 SHEET 52

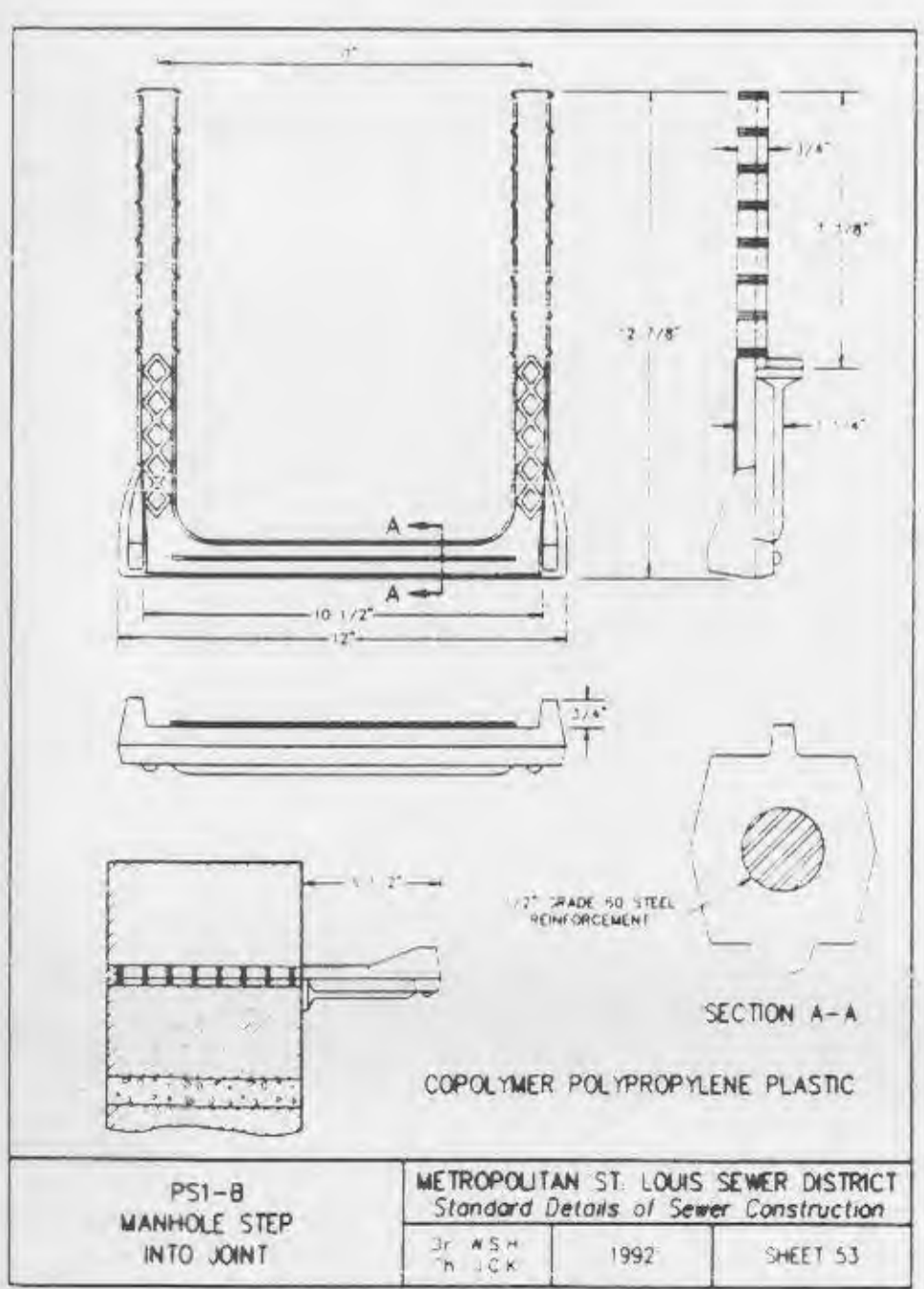

PS1-B MANHOLE STEP INTO JOINT  
 METROPOLITAN ST. LOUIS SEWER DISTRICT  
 Standard Details of Sewer Construction  
 1992 SHEET 53

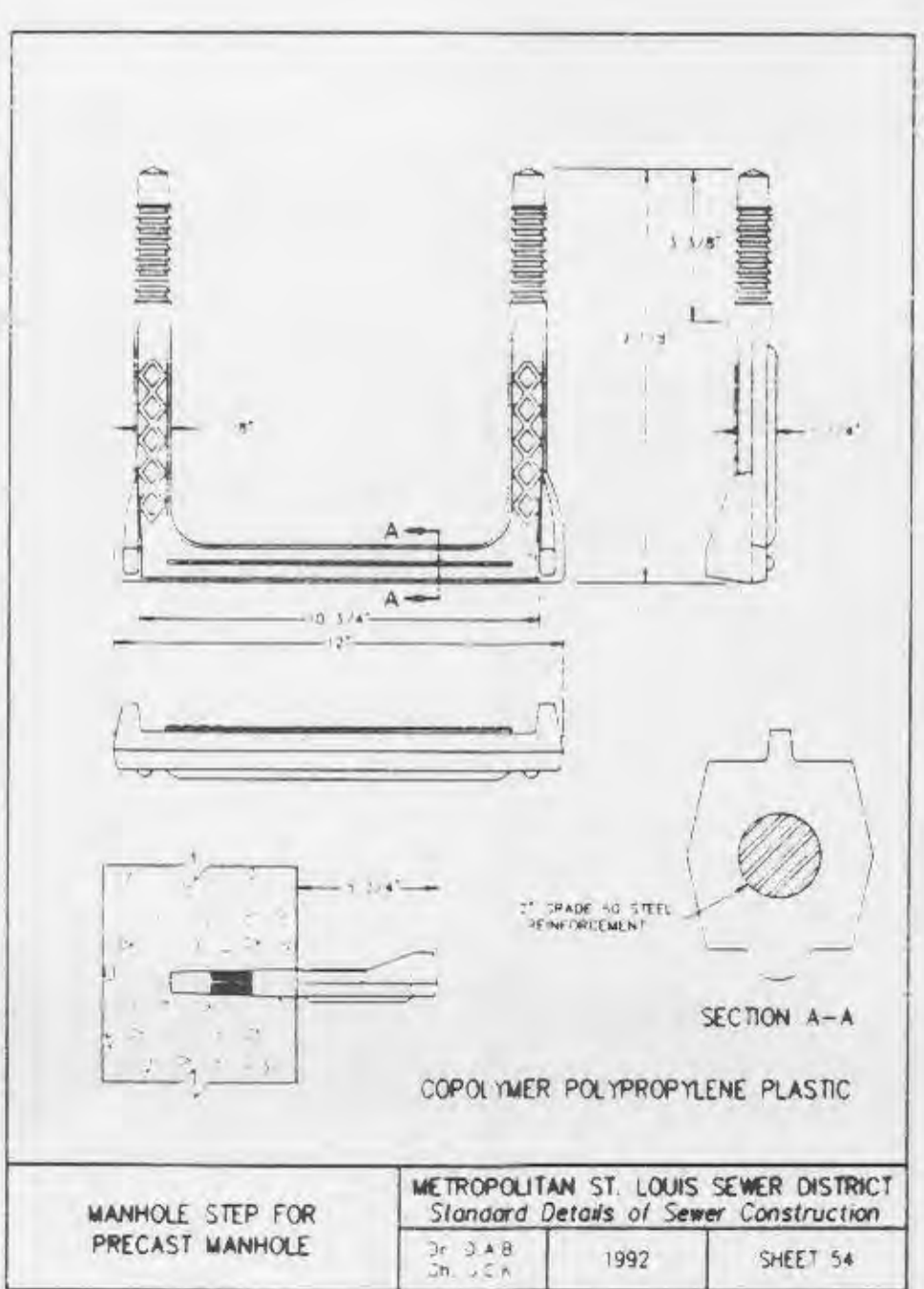

MANHOLE STEP FOR PRECAST MANHOLE  
 METROPOLITAN ST. LOUIS SEWER DISTRICT  
 Standard Details of Sewer Construction  
 1992 SHEET 54