

STORM SEWER PROFILES

HORIZONTAL SCALE: 1" = 20'
VERTICAL SCALE: 1" = 10'

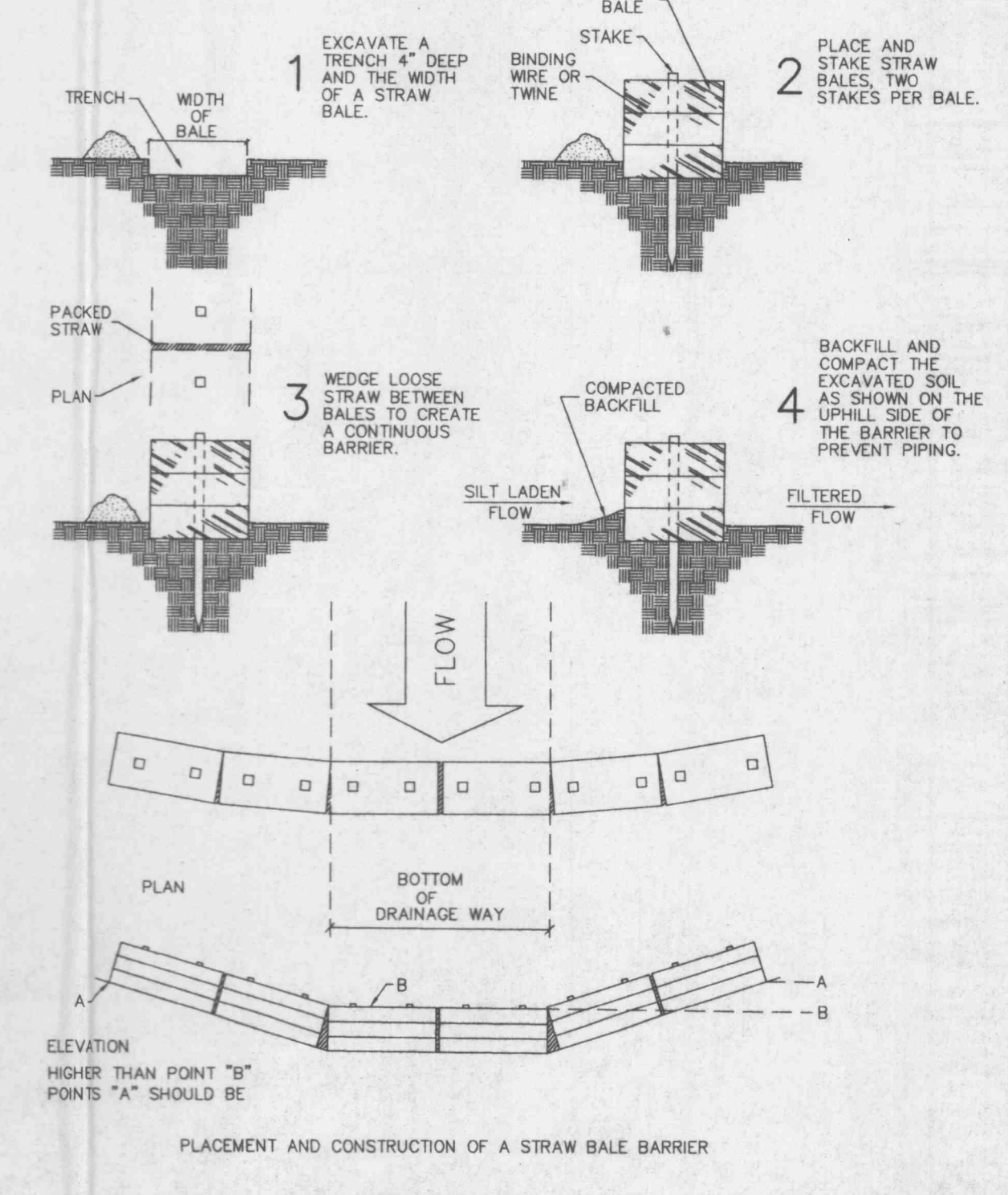
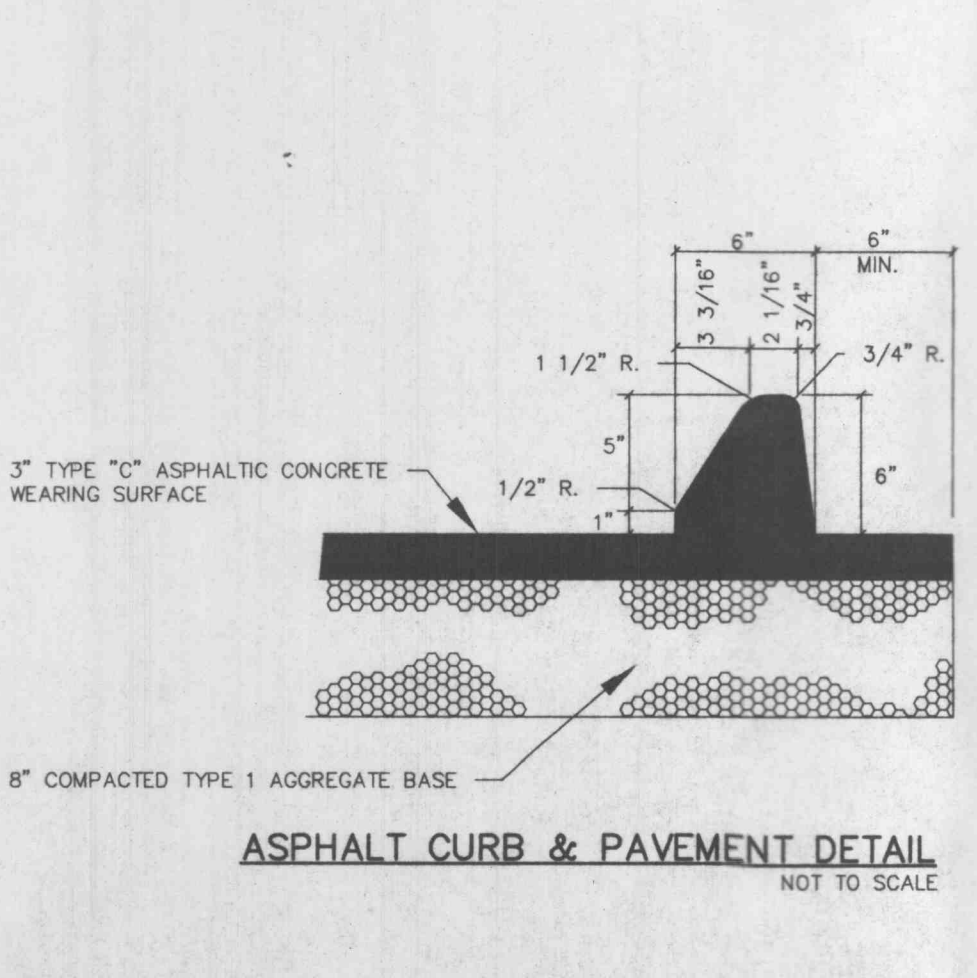
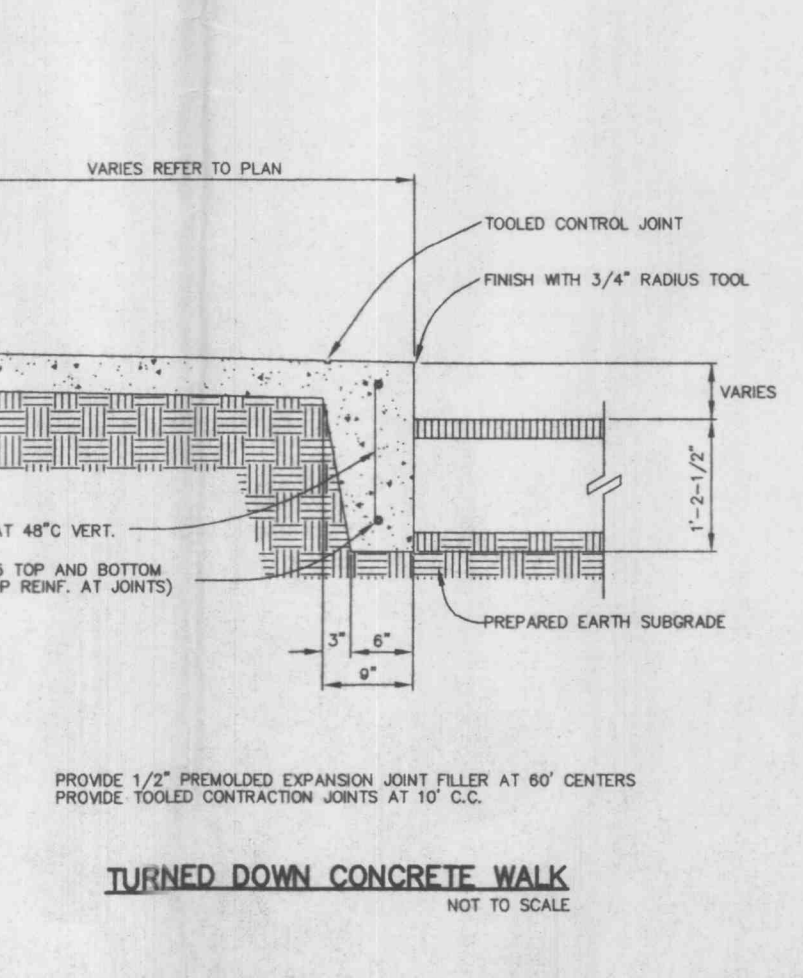
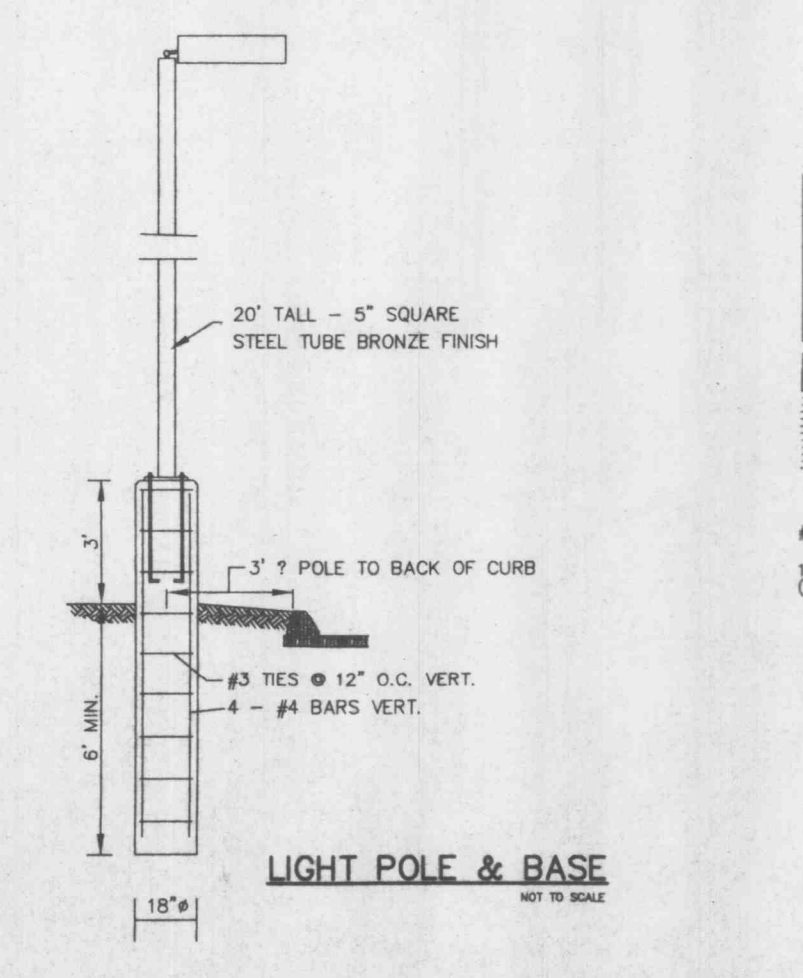
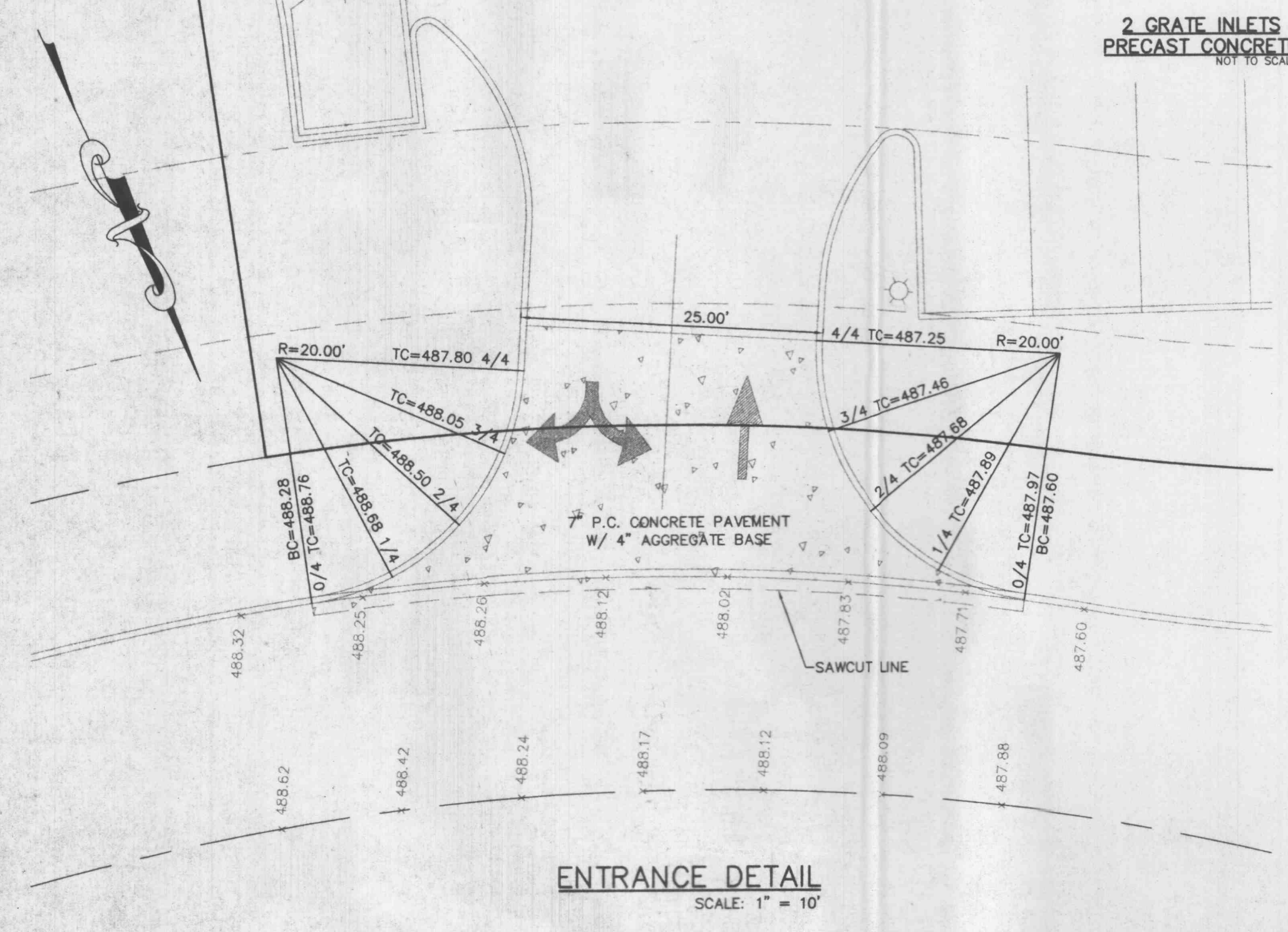
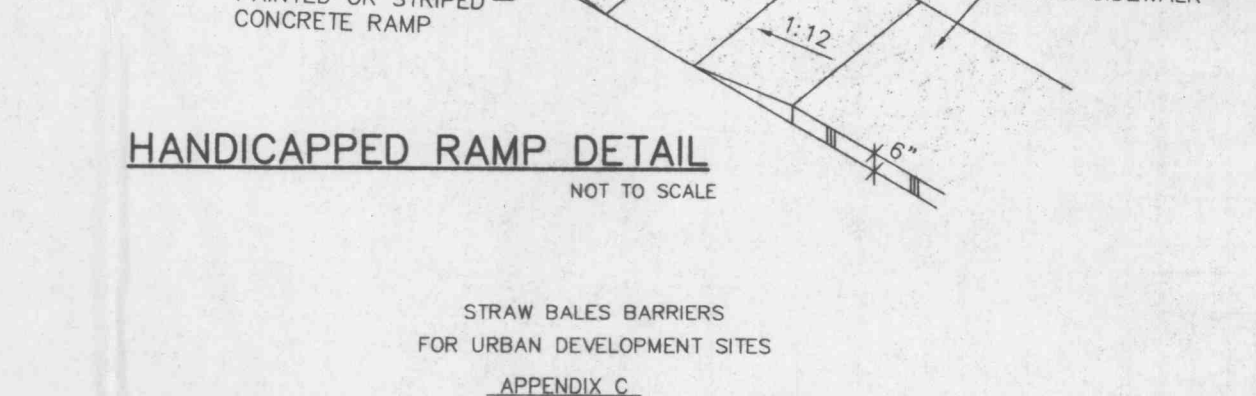
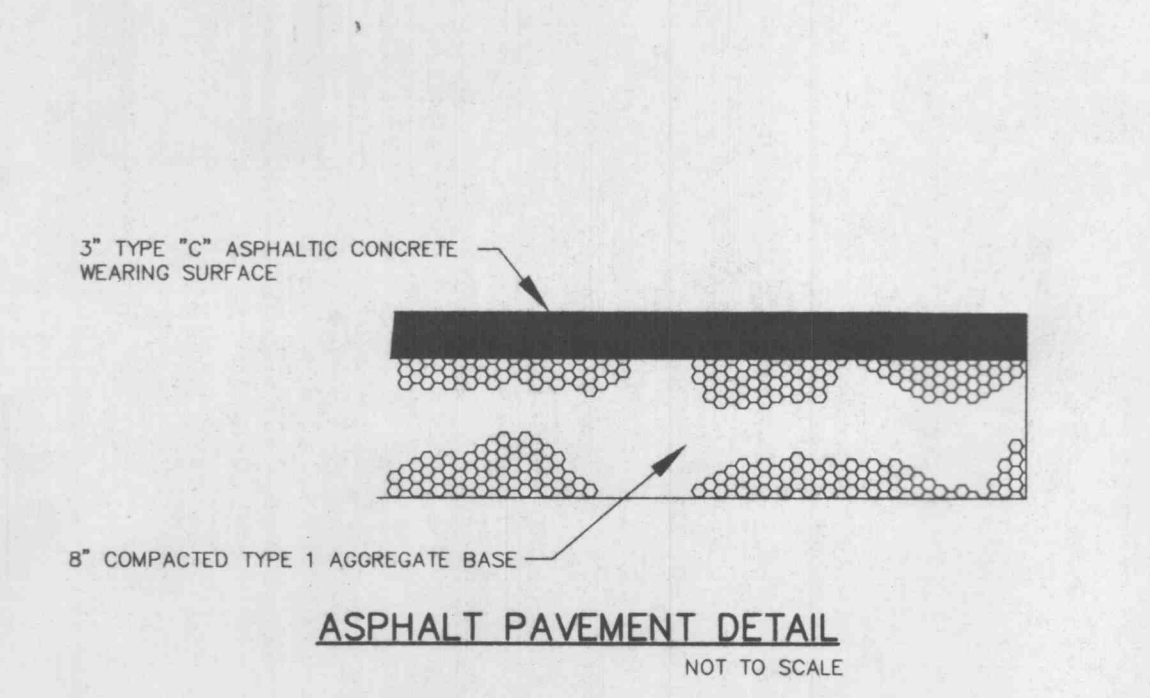
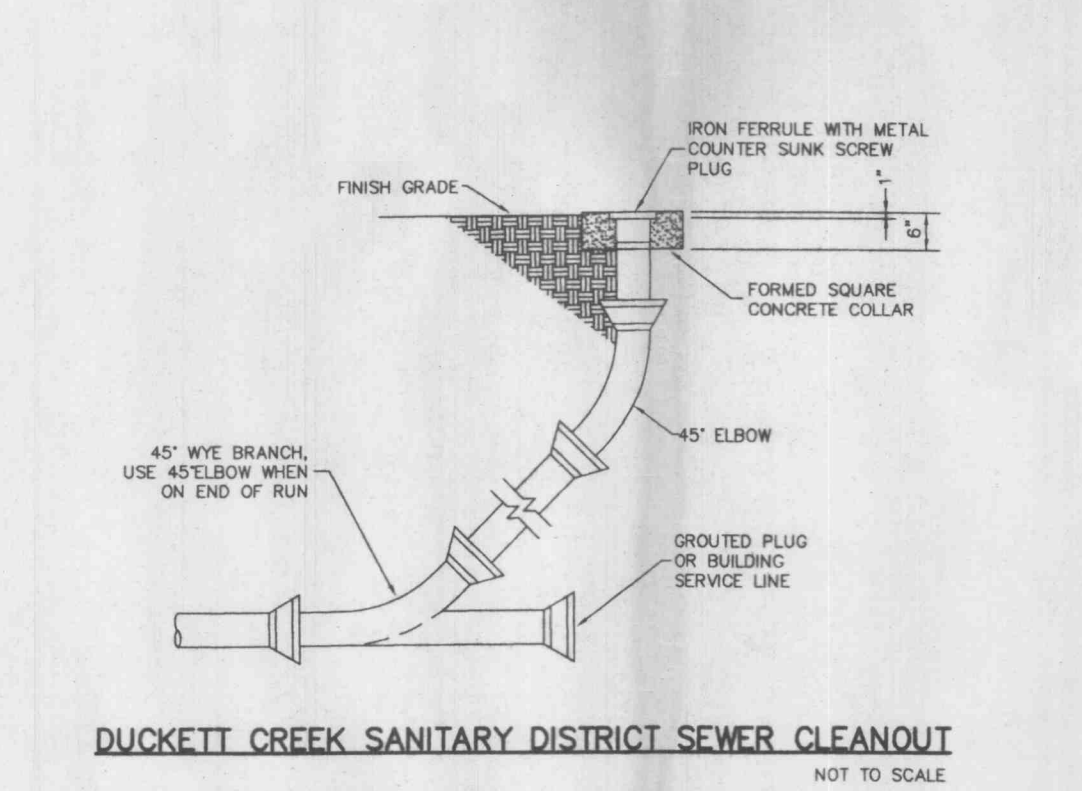
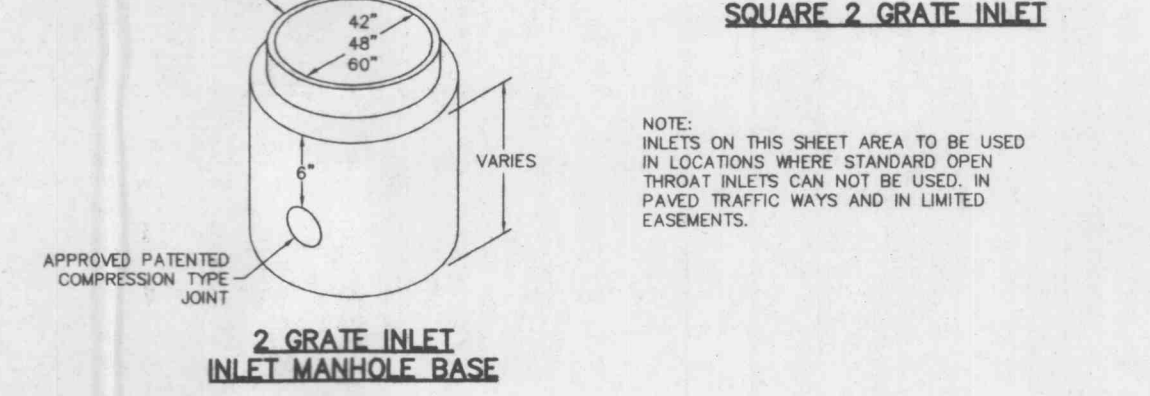
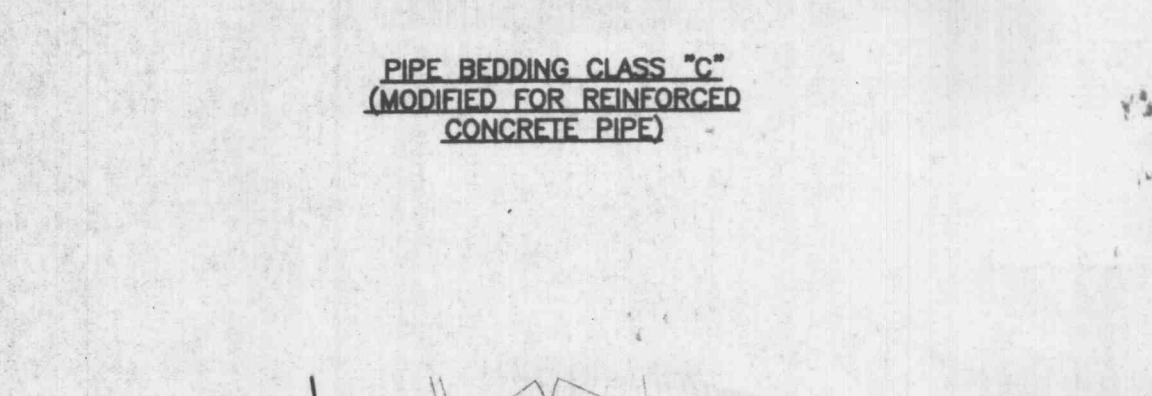
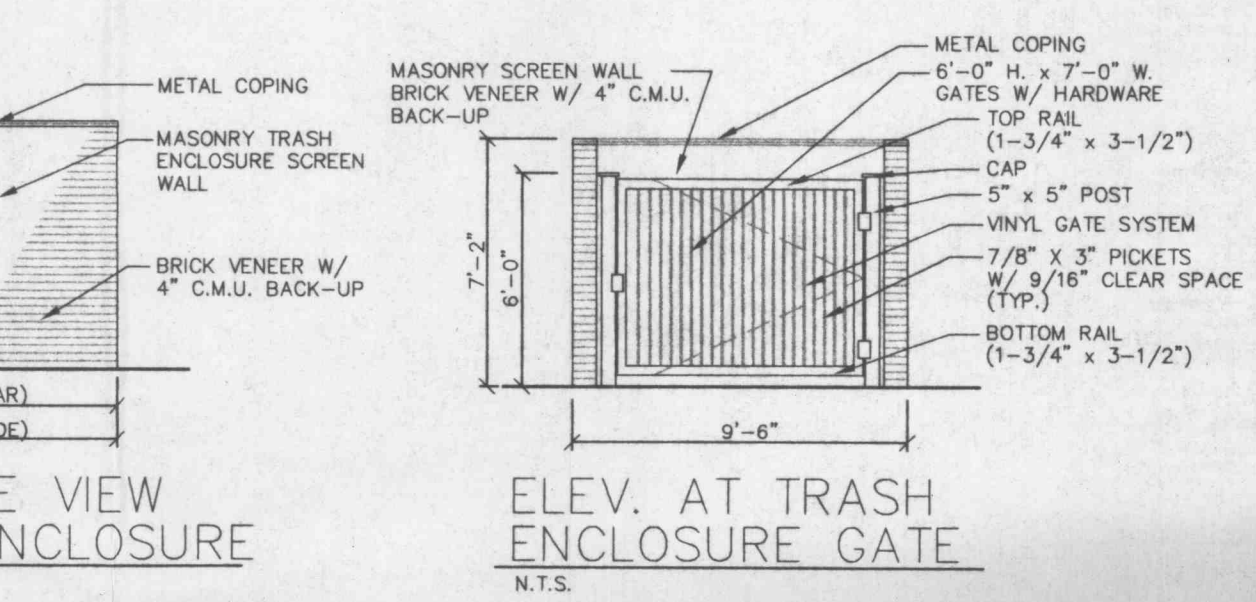
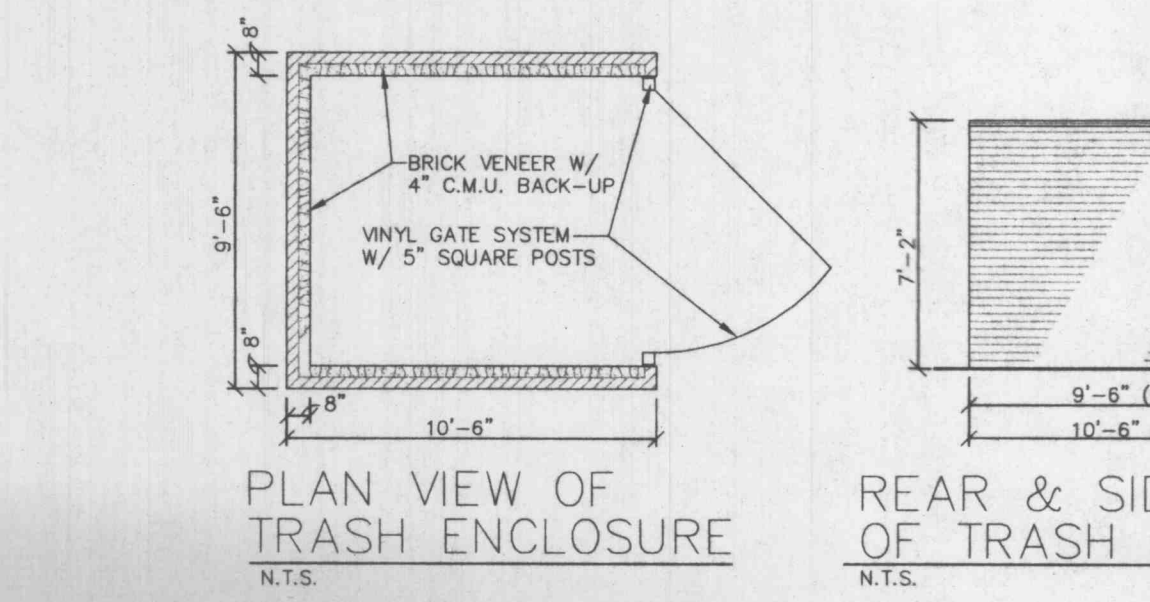
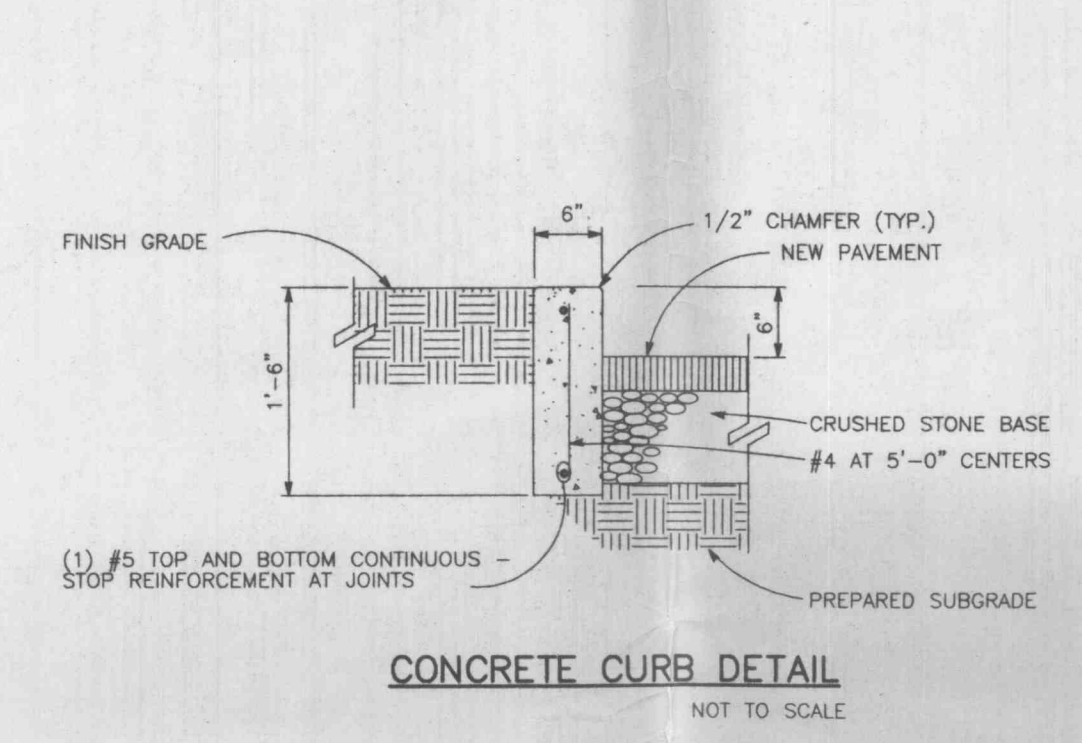
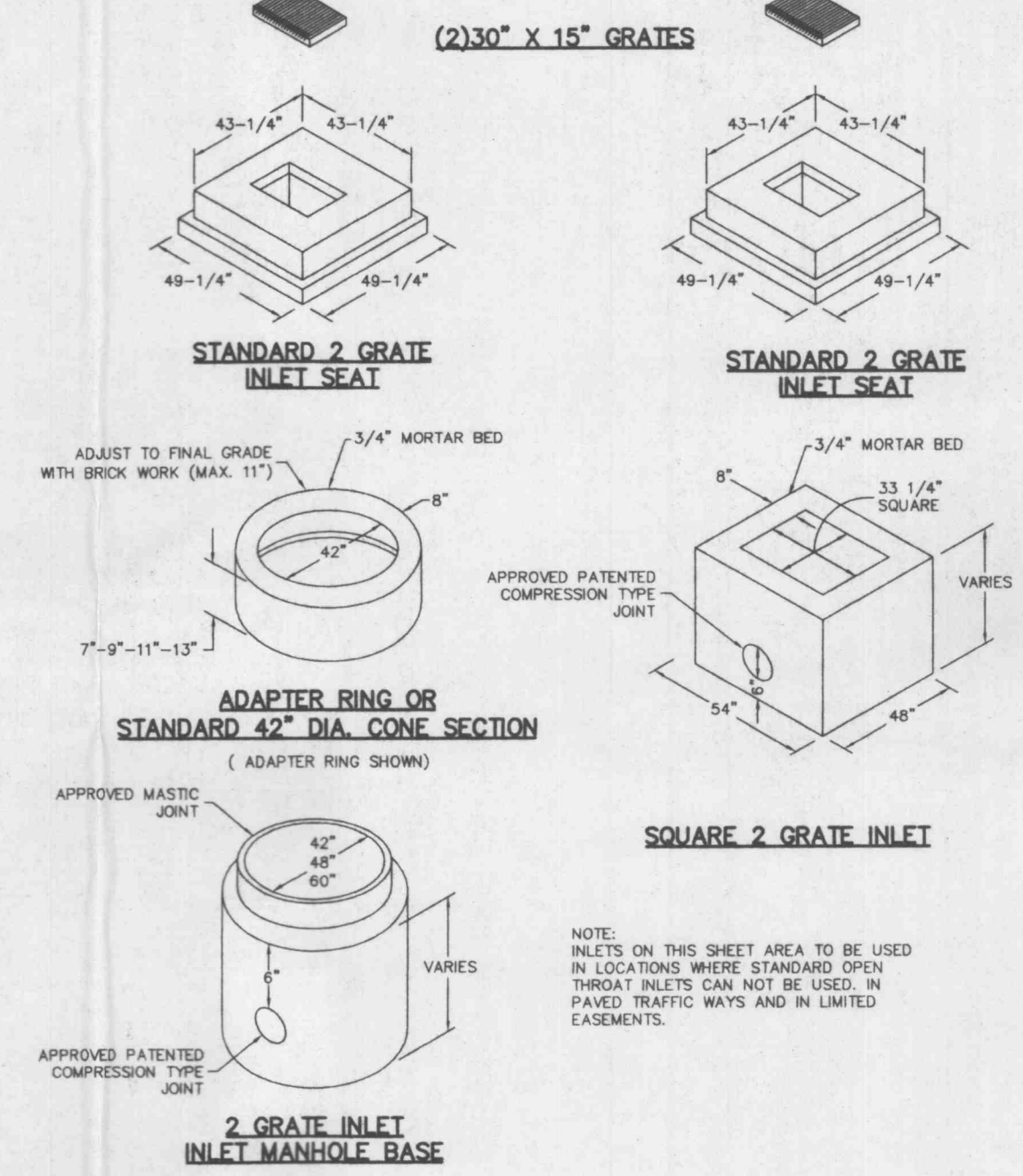
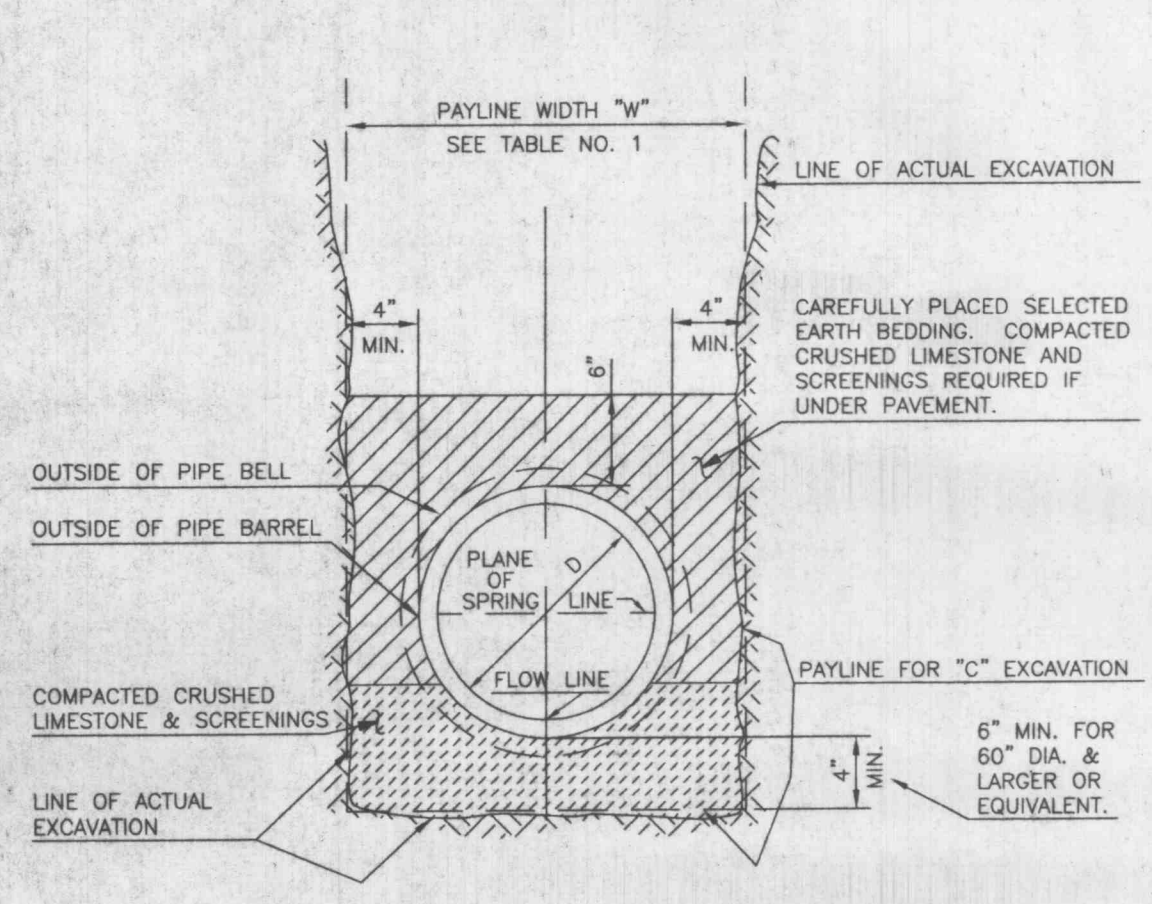

PREPARED FOR: **MBR HIGHWAY K PROPERTY, L.L.C.**
201 N. MAIN STREET, SUITE 300
ST. CHARLES, MO 63301
PHONE: (636) 947-4433 FAX: (636) 947-6917

DISCLAIMER OF RESPONSIBILITY
I hereby certify that the documents intended to be authenticated by my seal are limited to this sheet, and I hereby disclaim any responsibility for all other Drawings, Specifications, Estimates, Reports or other documents or instruments relating to or intended to be used for any part or parts of the architectural or engineering project or survey.

Copyright 1998
Bos Engineering Company, Inc.
All Rights Reserved

REVISIONS	
12-18-00	CITY COMMENTS
1-30-01	ADD C.O. DETAIL
3-09-01	MODOT COMMENTS
5-22-01	MODOT COMMENTS

Bos

ENGINEERING
PLANNING
SURVEYING

1052 South Cloverleaf Drive
St. Peters, MO. 63376-6445
314-928-5552
FAX 928-1718

11-1-00
DATE
95-7218H
PROJECT NUMBER
4 OF 4
SHEET OF
7218HCON.DWG
FILE NAME
ALJ CLH
DRAWN CHECKED

E:\VME\7000P\457218H\Drawings\7218Hcon.dwg Fr. Jun 22 09 21:23 2001 STATION 11 SCOTT L.