

ROUND PIPE				HORIZONTAL ELLIPTICAL PIPE			
DEPTH OF PIPE (INCHES)	WIDTH OF PIPE (INCHES)	PAVING MATERIAL (INCHES)	CONCRETE (INCHES)	DEPTH OF PIPE (INCHES)	WIDTH OF PIPE (INCHES)	PAVING MATERIAL (INCHES)	CONCRETE (INCHES)
4	3	2.00	1.50	4	3	2.00	1.50
6	5	2.50	2.00	6	5	2.50	2.00
8	7	3.00	2.50	8	7	3.00	2.50
10	9	3.50	3.00	10	9	3.50	3.00
12	11	4.00	3.50	12	11	4.00	3.50
14	13	4.50	4.00	14	13	4.50	4.00
16	15	5.00	4.50	16	15	5.00	4.50
18	17	5.50	5.00	18	17	5.50	5.00
20	19	6.00	5.50	20	19	6.00	5.50
22	21	6.50	6.00	22	21	6.50	6.00
24	23	7.00	6.50	24	23	7.00	6.50
26	25	7.50	7.00	26	25	7.50	7.00
28	27	8.00	7.50	28	27	8.00	7.50
30	29	8.50	8.00	30	29	8.50	8.00
32	31	9.00	8.50	32	31	9.00	8.50
34	33	9.50	9.00	34	33	9.50	9.00
36	35	10.00	9.50	36	35	10.00	9.50
38	37	10.50	10.00	38	37	10.50	10.00
40	39	11.00	10.50	40	39	11.00	10.50
42	41	11.50	11.00	42	41	11.50	11.00
44	43	12.00	11.50	44	43	12.00	11.50
46	45	12.50	12.00	46	45	12.50	12.00
48	47	13.00	12.50	48	47	13.00	12.50
50	49	13.50	13.00	50	49	13.50	13.00
52	51	14.00	13.50	52	51	14.00	13.50
54	53	14.50	14.00	54	53	14.50	14.00
56	55	15.00	14.50	56	55	15.00	14.50
58	57	15.50	15.00	58	57	15.50	15.00
60	59	16.00	15.50	60	59	16.00	15.50
62	61	16.50	16.00	62	61	16.50	16.00
64	63	17.00	16.50	64	63	17.00	16.50
66	65	17.50	17.00	66	65	17.50	17.00
68	67	18.00	17.50	68	67	18.00	17.50
70	69	18.50	18.00	70	69	18.50	18.00
72	71	19.00	18.50	72	71	19.00	18.50
74	73	19.50	19.00	74	73	19.50	19.00
76	75	20.00	19.50	76	75	20.00	19.50
78	77	20.50	20.00	78	77	20.50	20.00
80	79	21.00	20.50	80	79	21.00	20.50
82	81	21.50	21.00	82	81	21.50	21.00
84	83	22.00	21.50	84	83	22.00	21.50
86	85	22.50	22.00	86	85	22.50	22.00
88	87	23.00	22.50	88	87	23.00	22.50
90	89	23.50	23.00	90	89	23.50	23.00
92	91	24.00	23.50	92	91	24.00	23.50
94	93	24.50	24.00	94	93	24.50	24.00
96	95	25.00	24.50	96	95	25.00	24.50
98	97	25.50	25.00	98	97	25.50	25.00
100	99	26.00	25.50	100	99	26.00	25.50

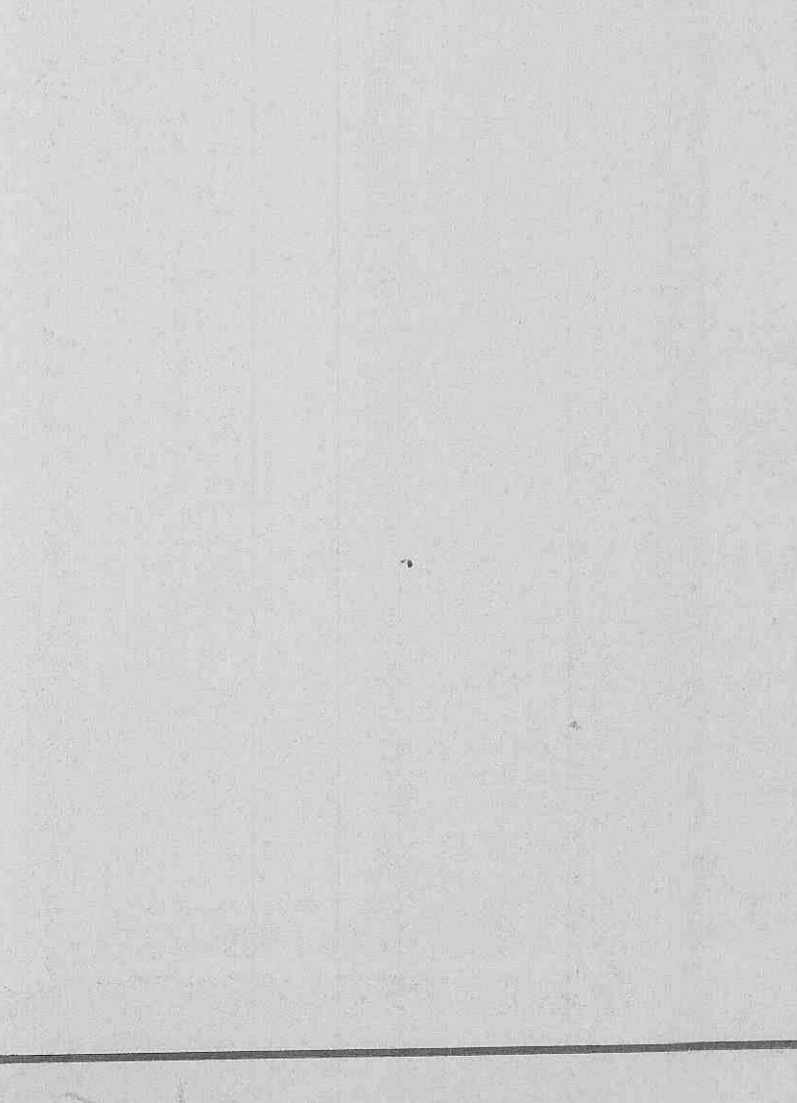
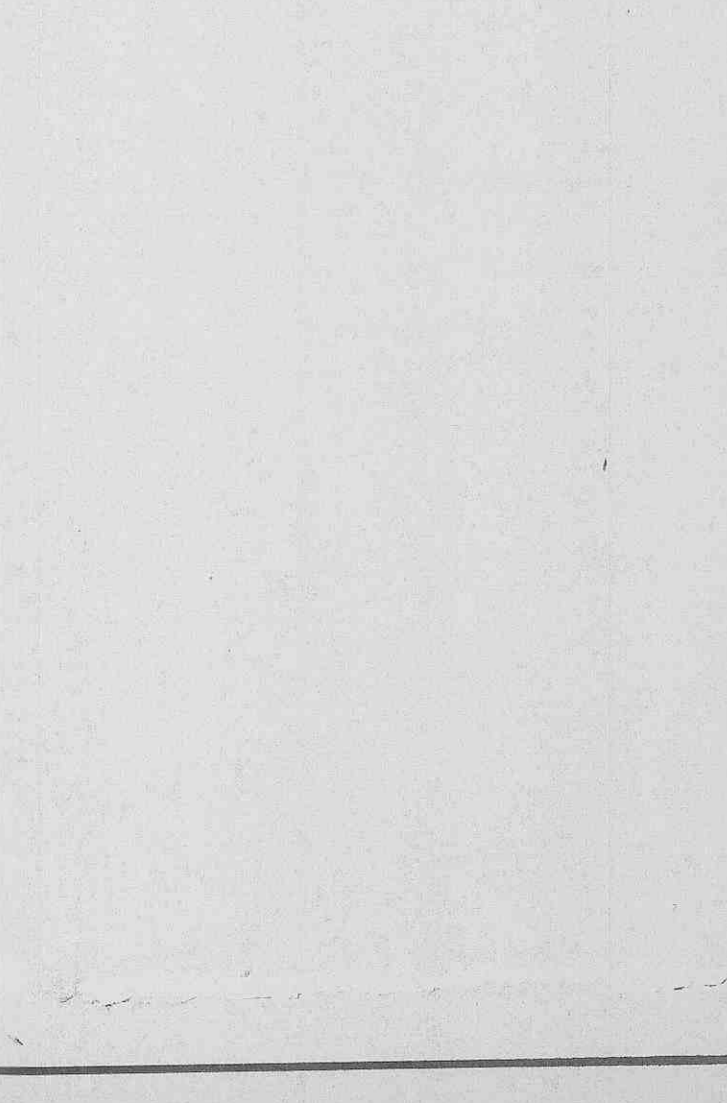
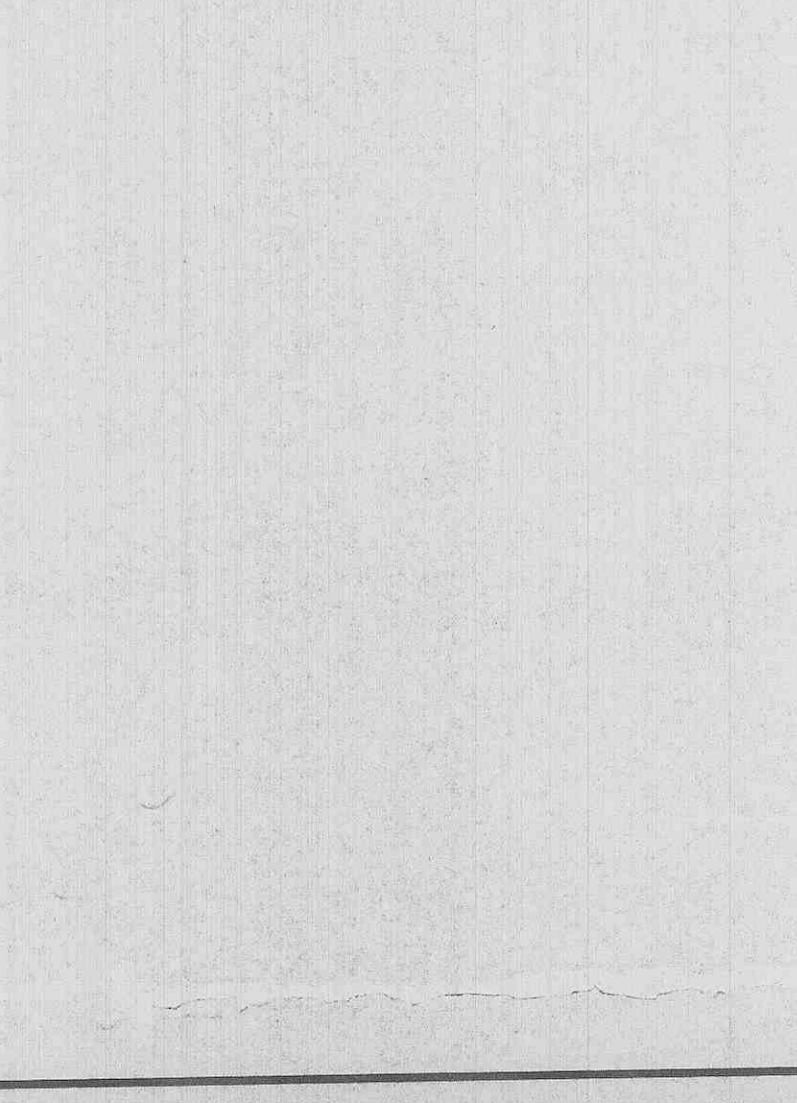
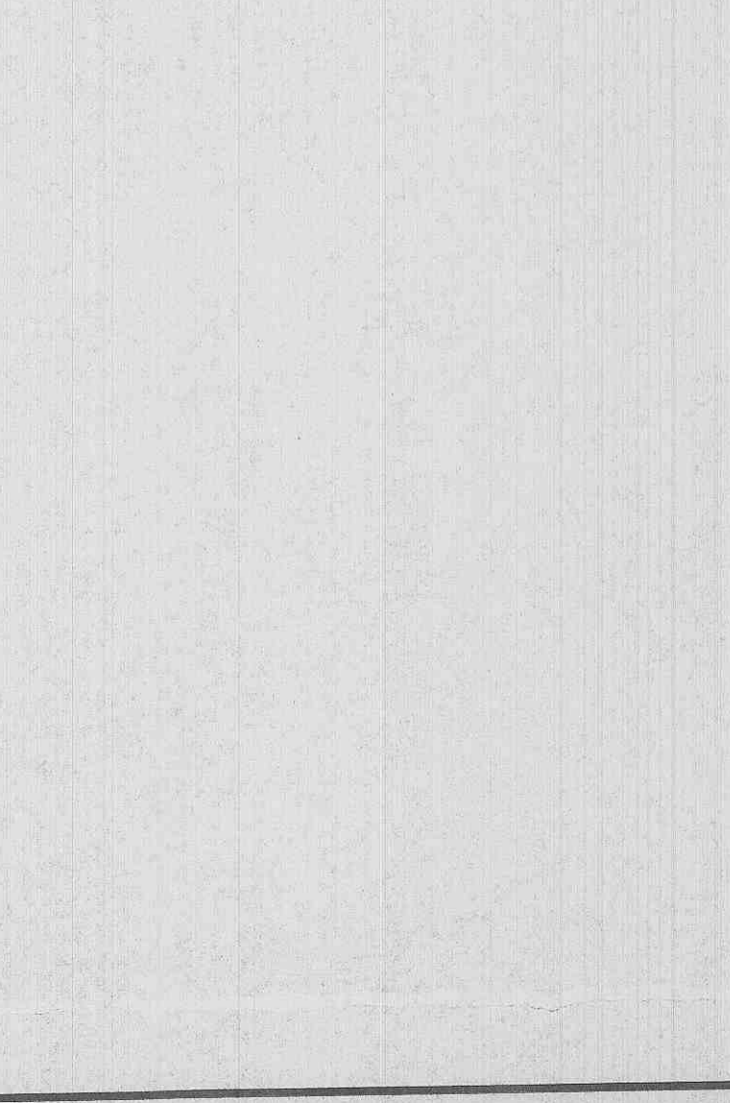
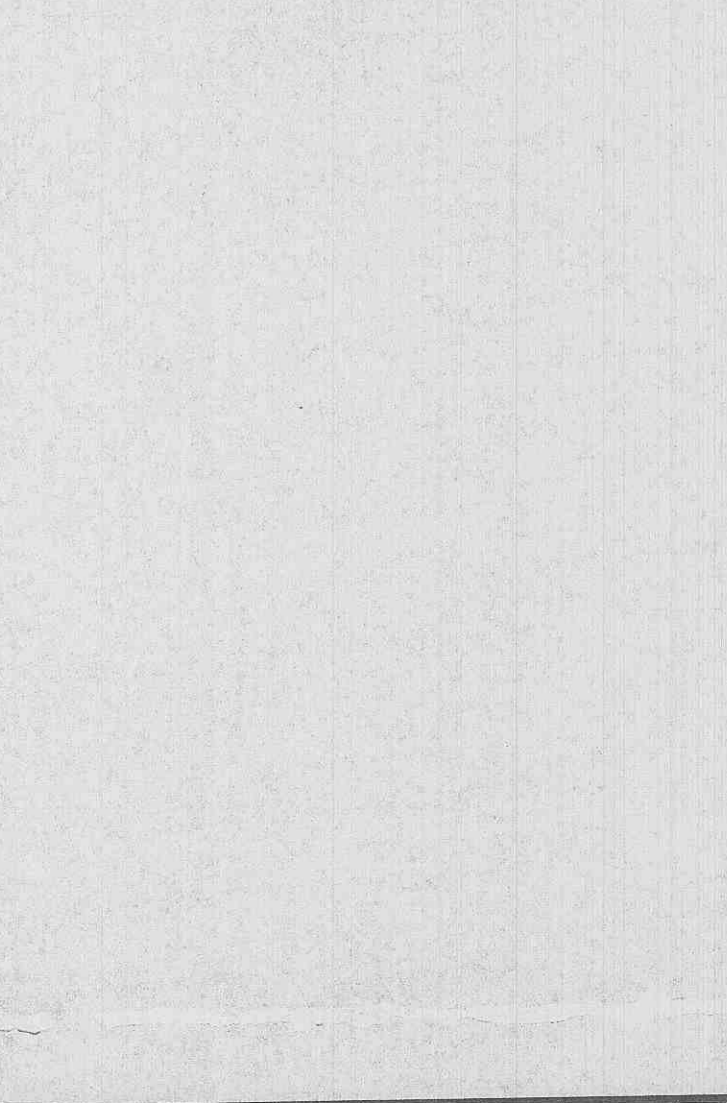
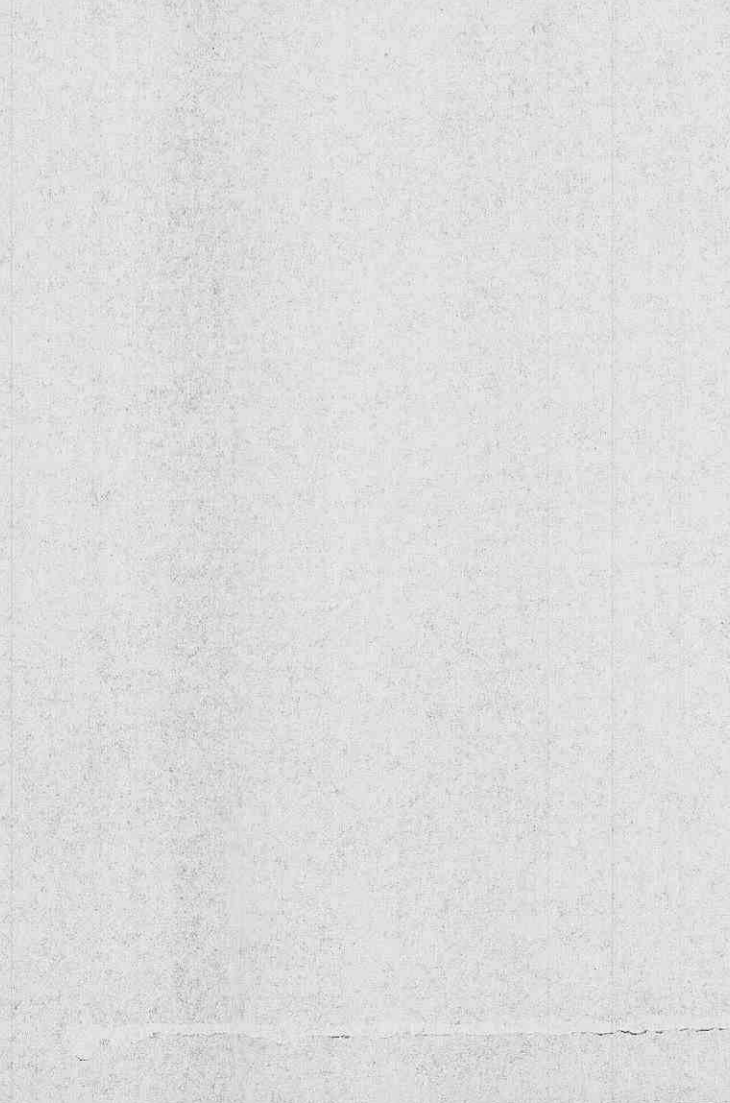
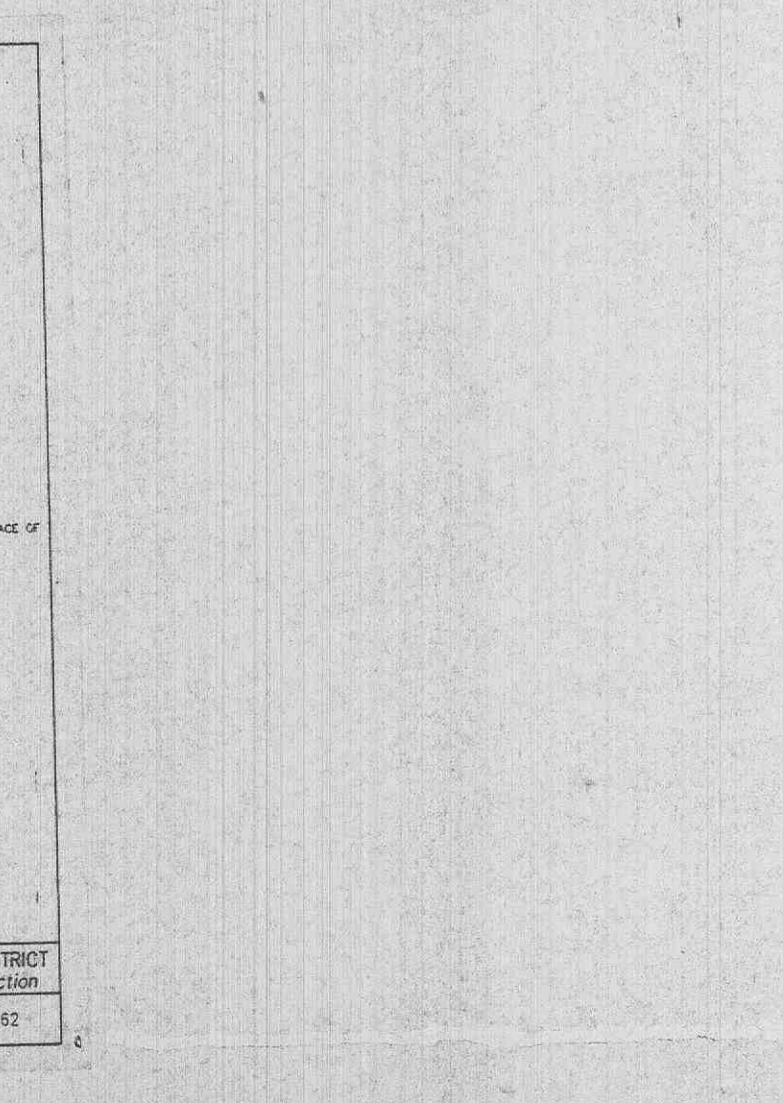
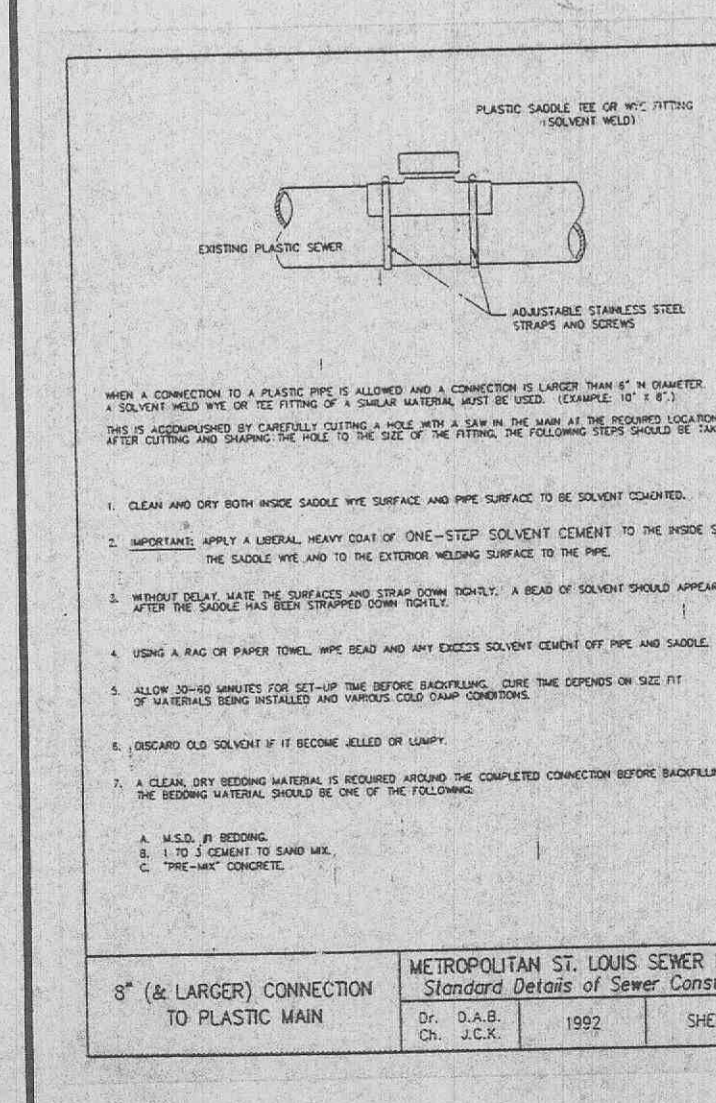
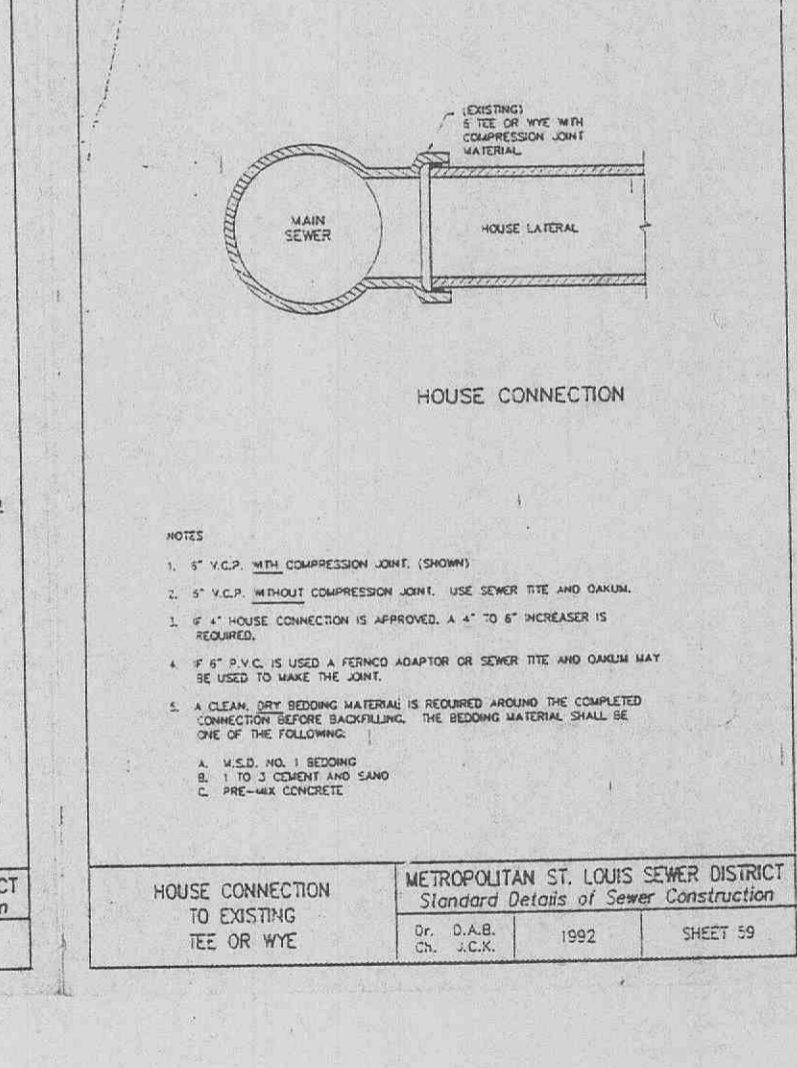
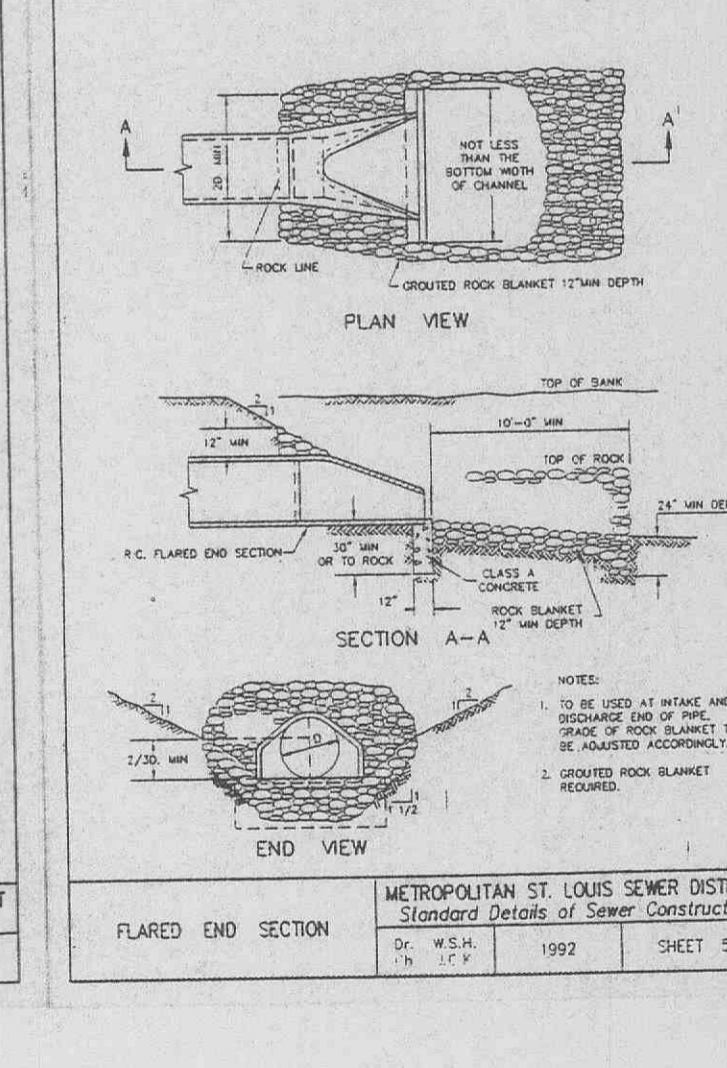
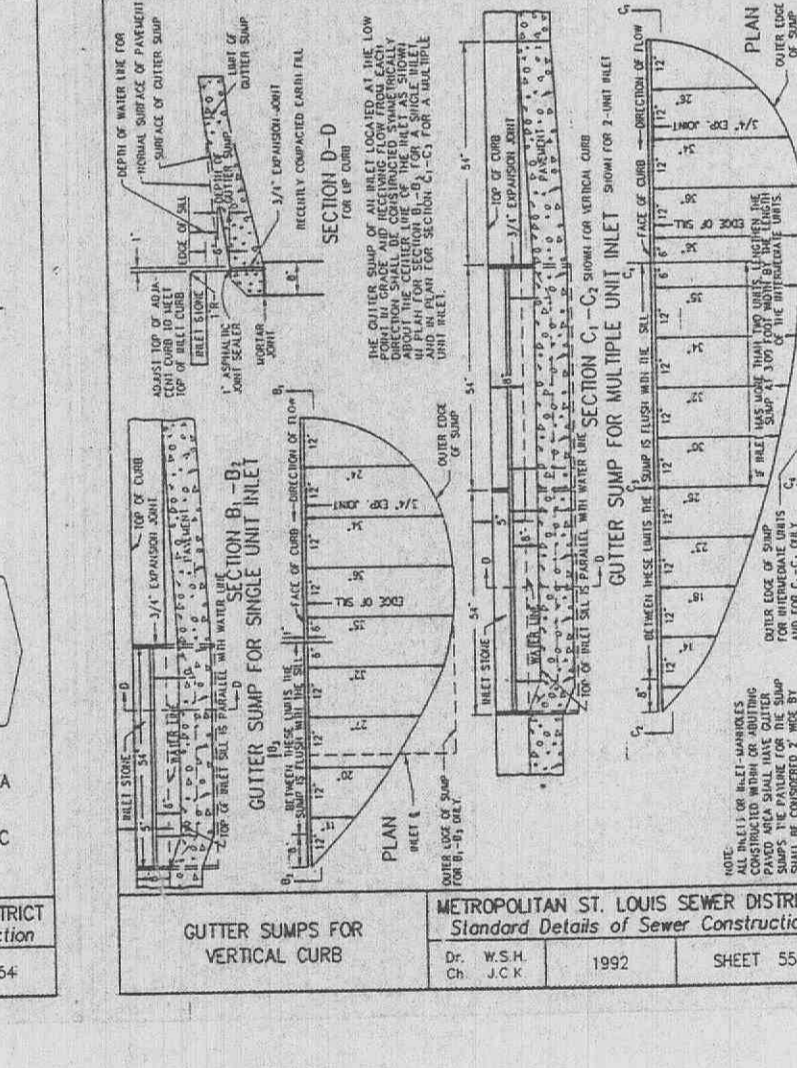
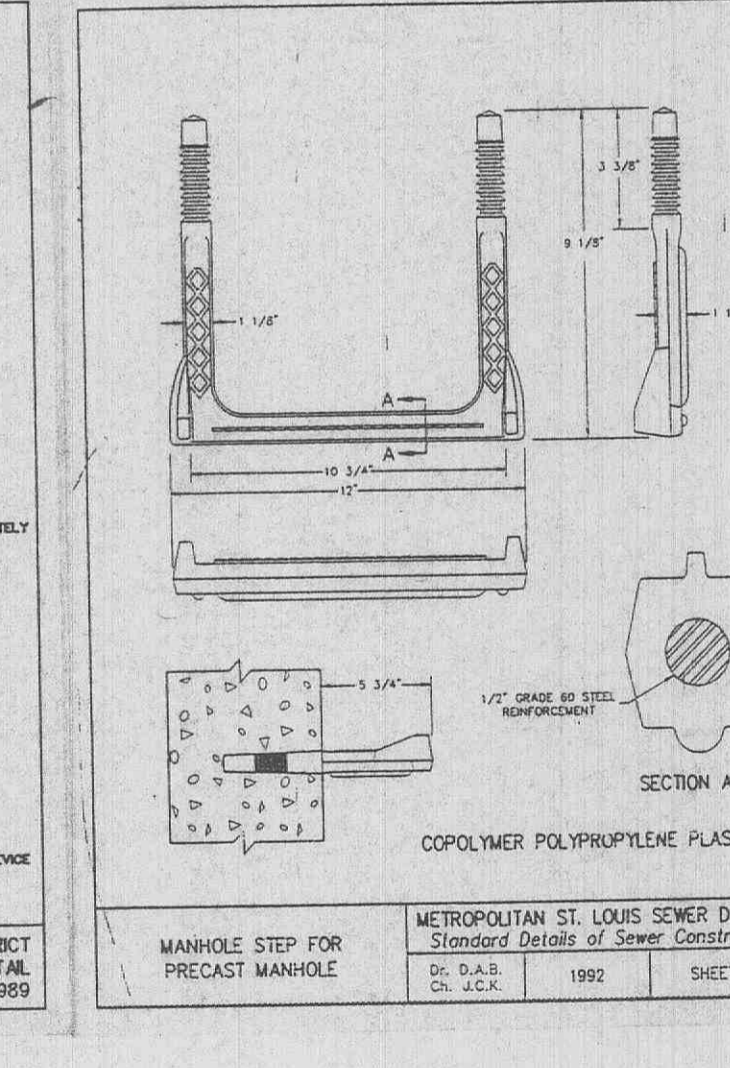
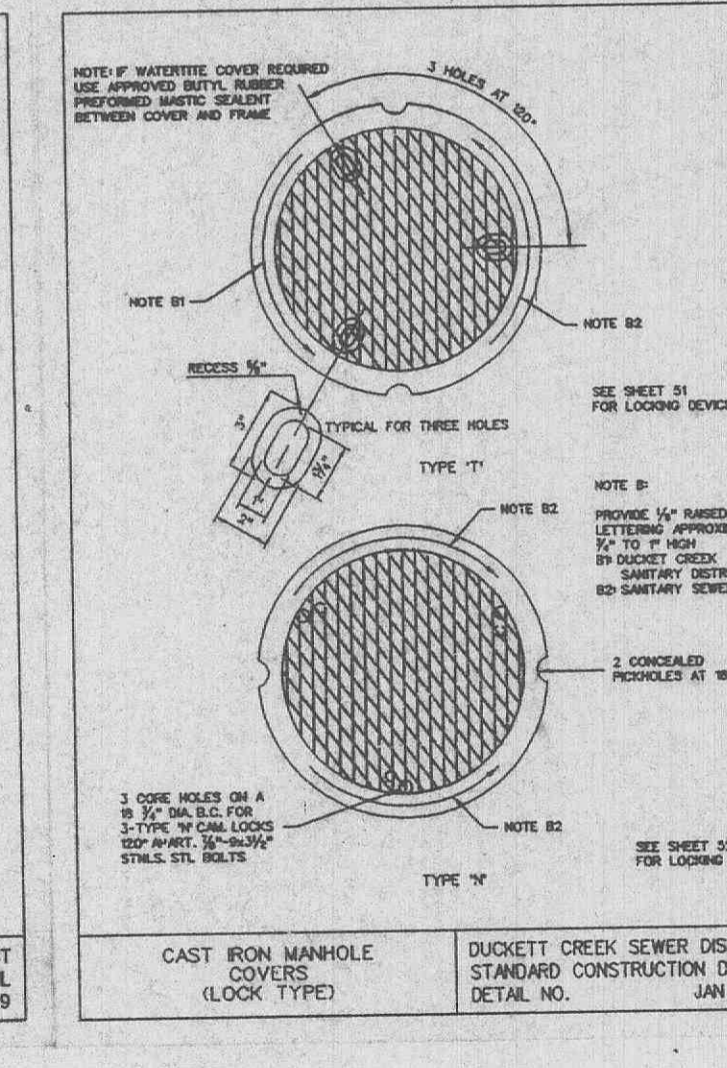
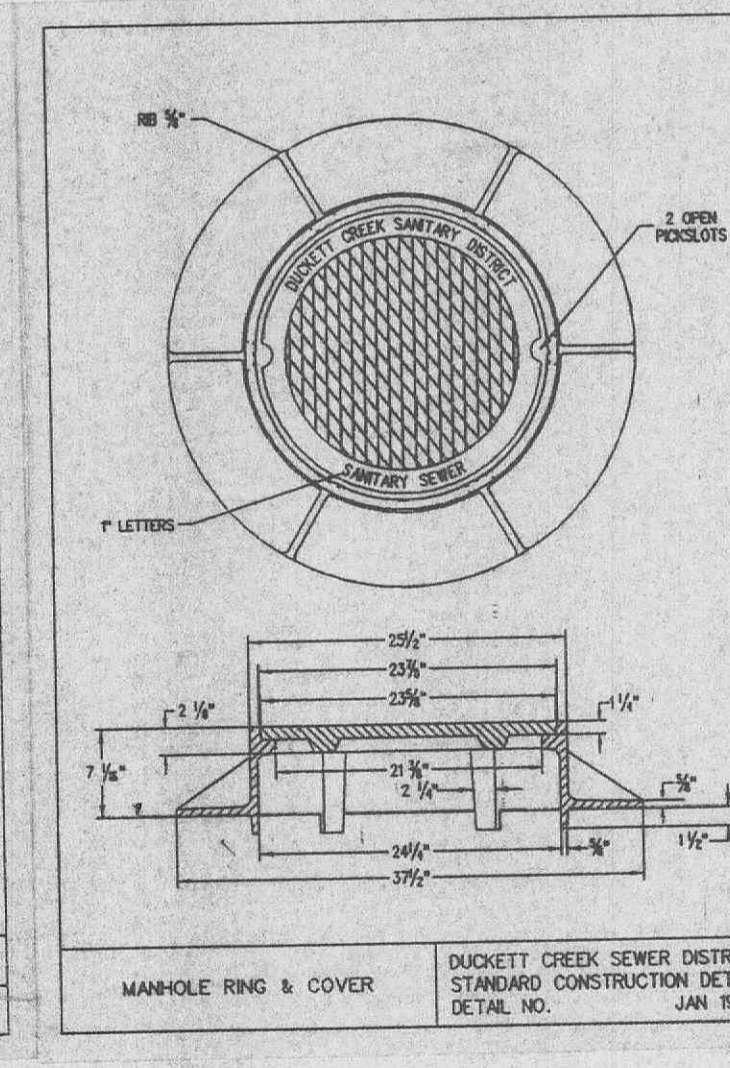
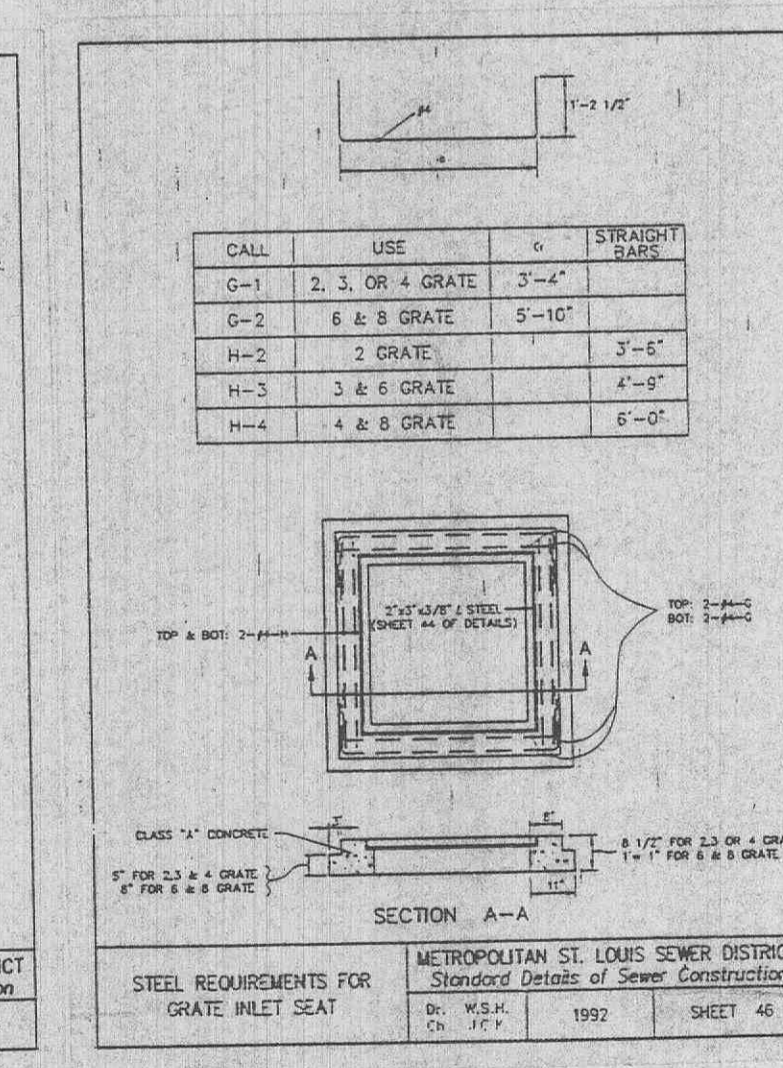
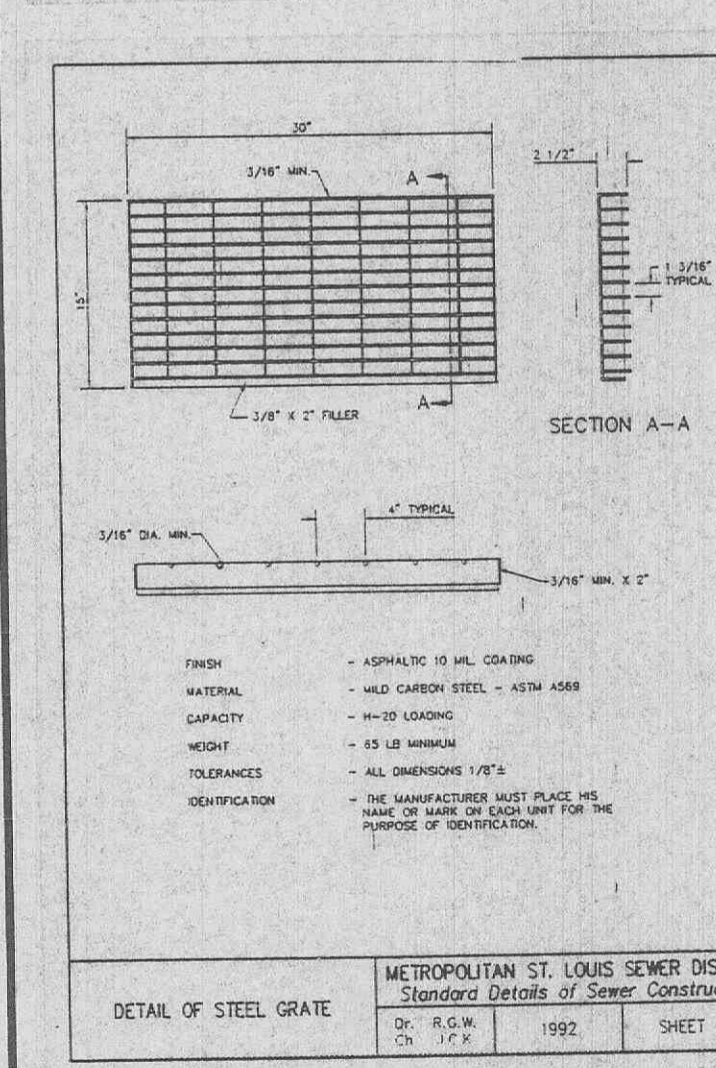
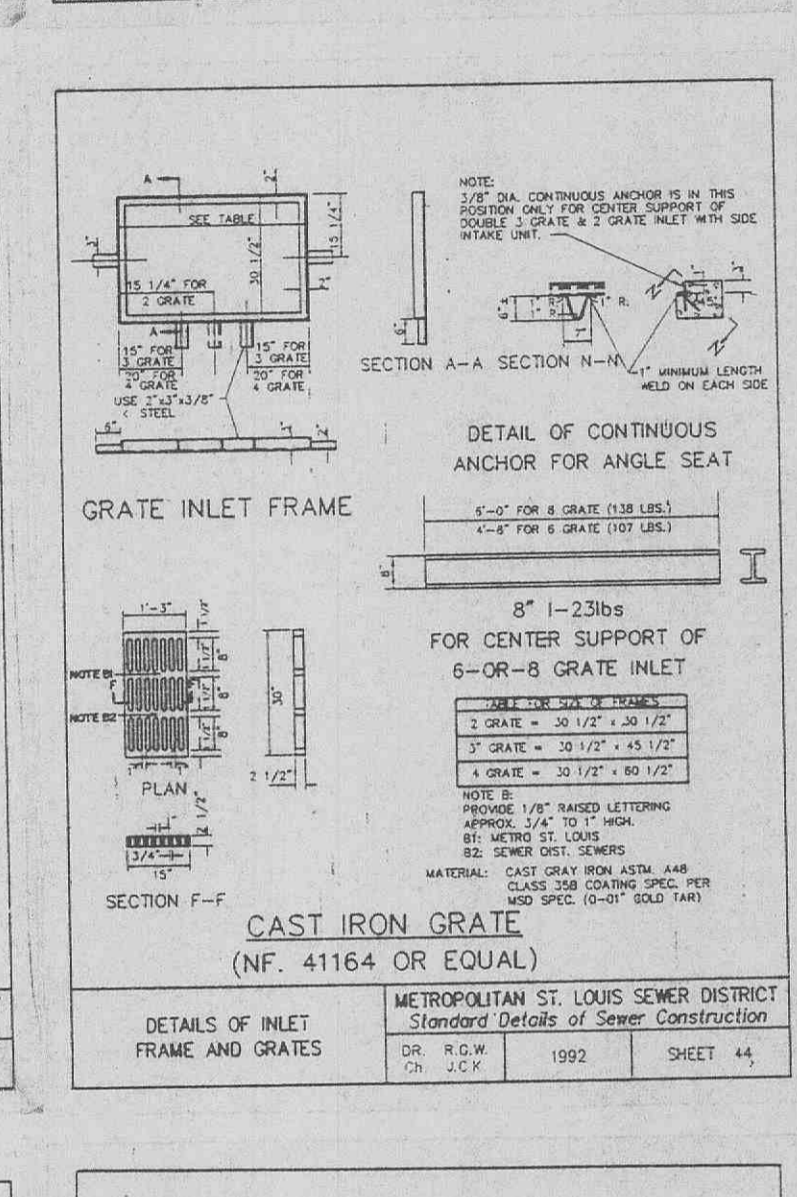
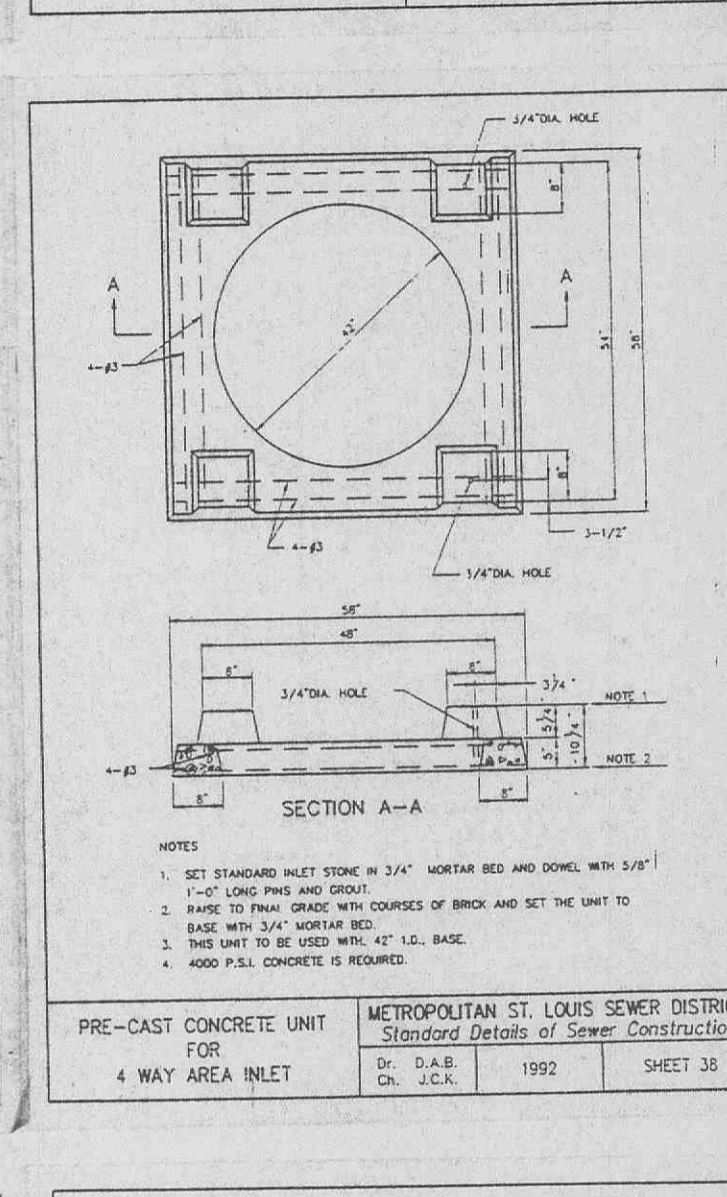
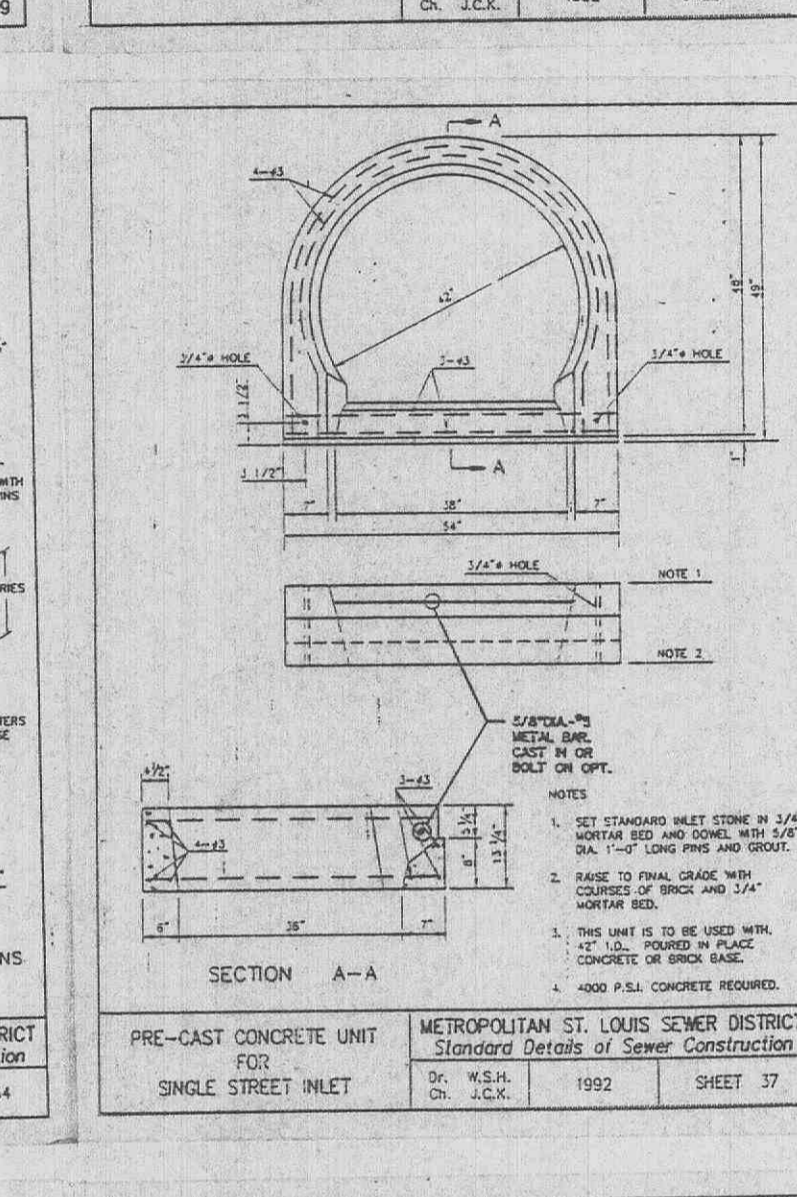
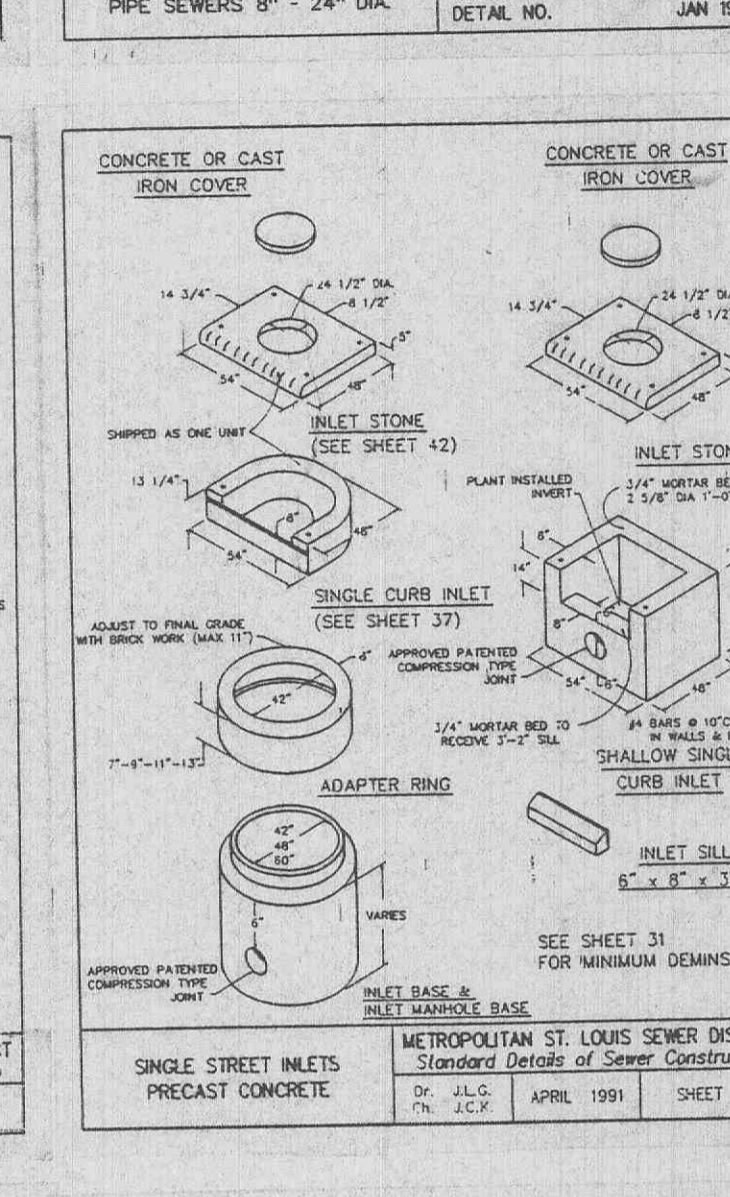
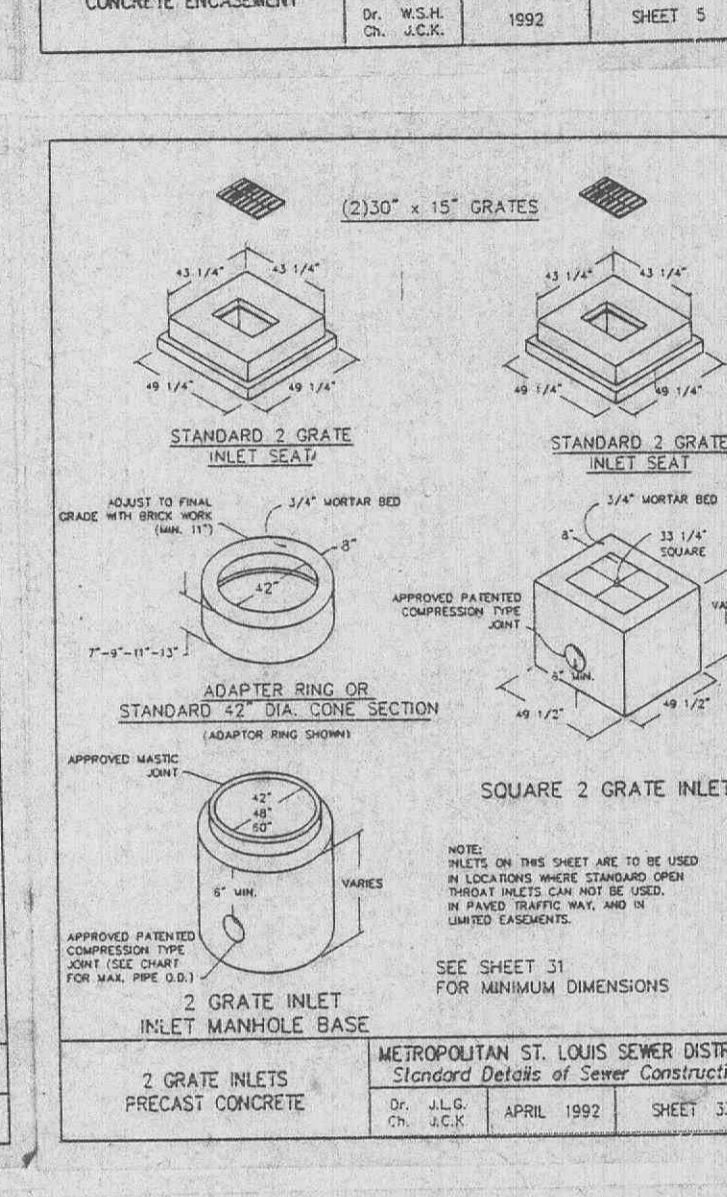
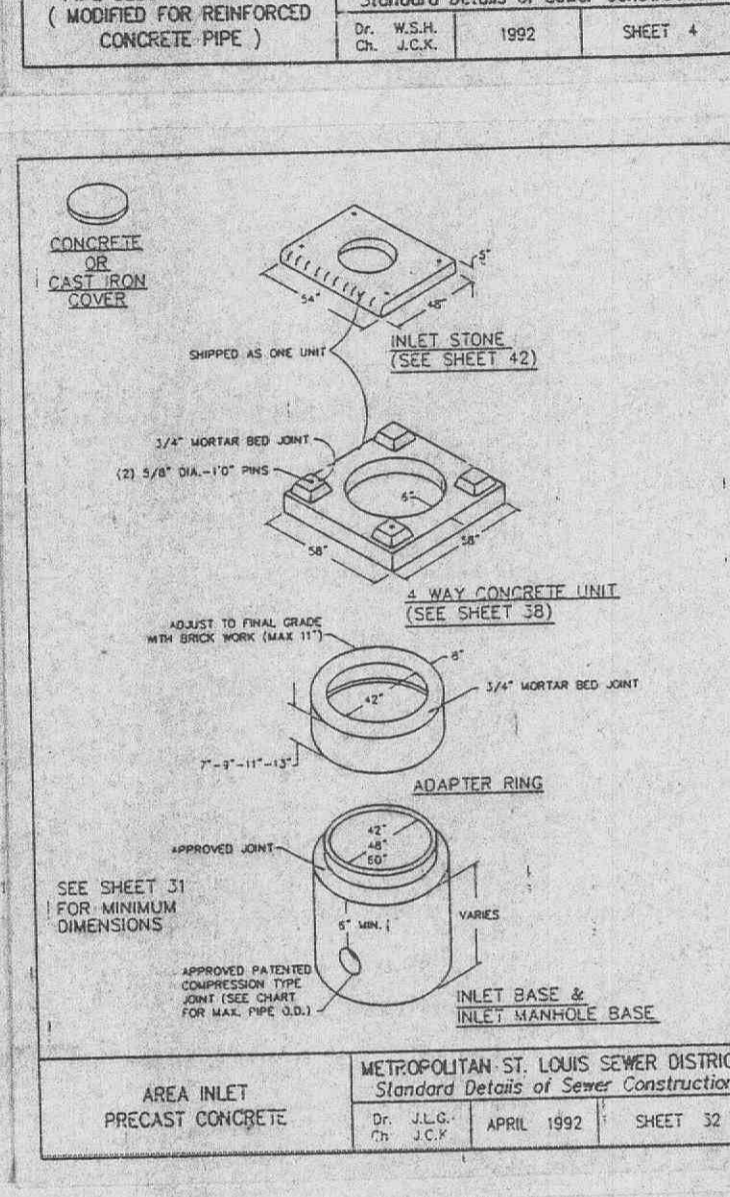
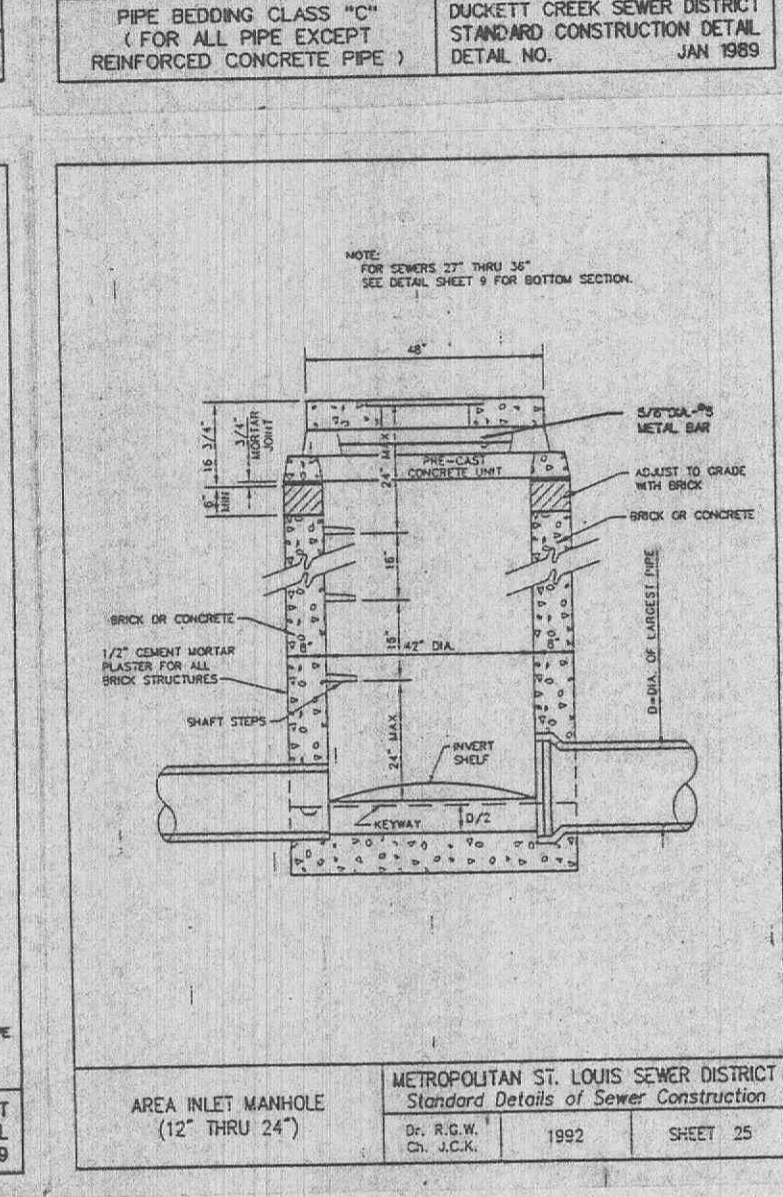
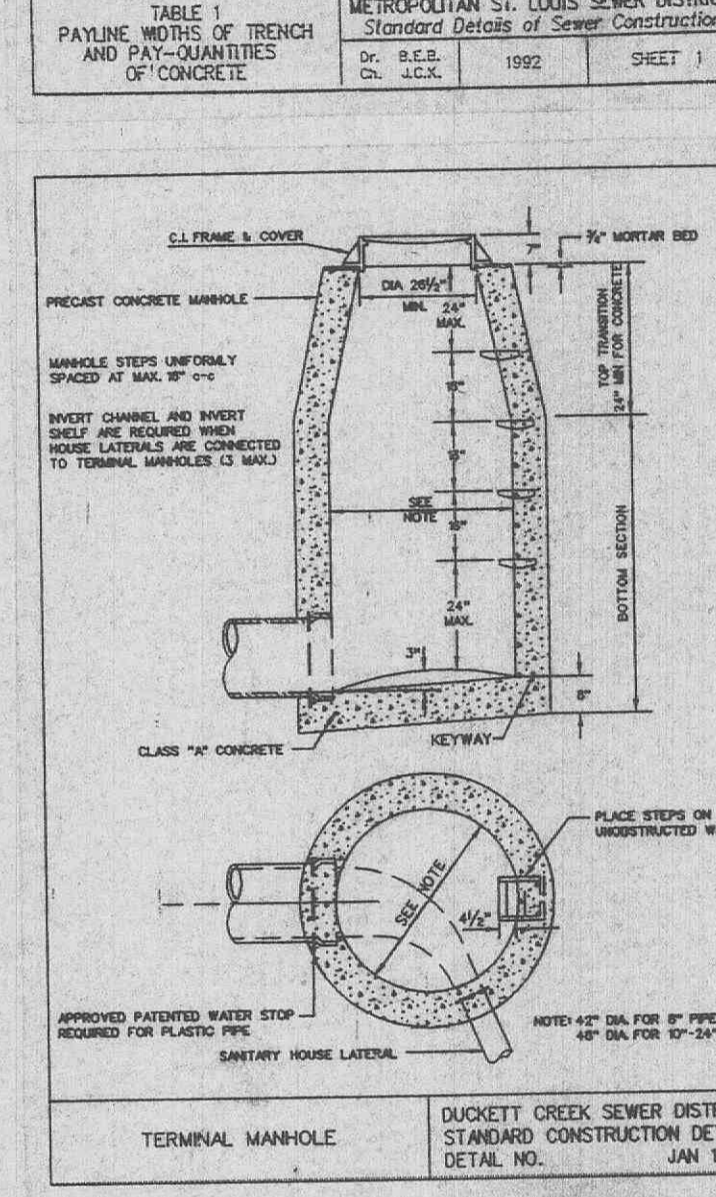
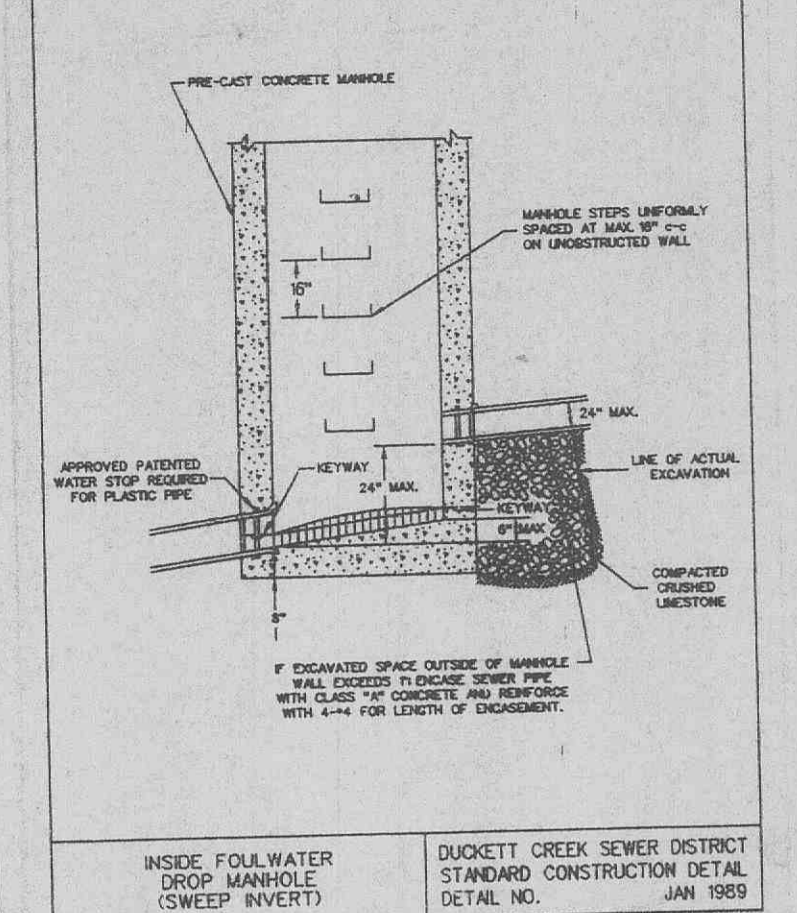
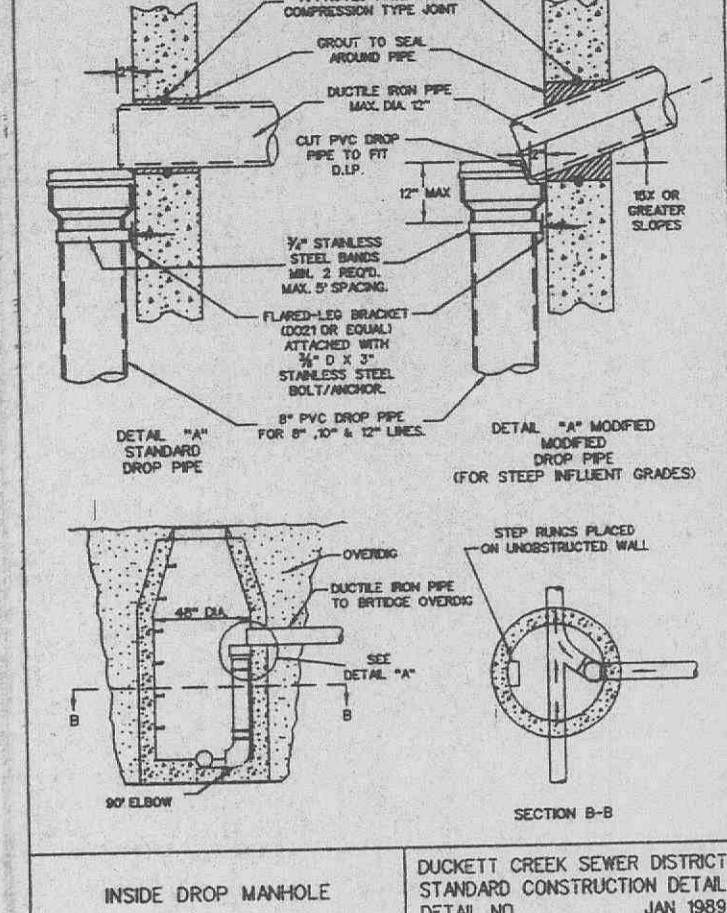
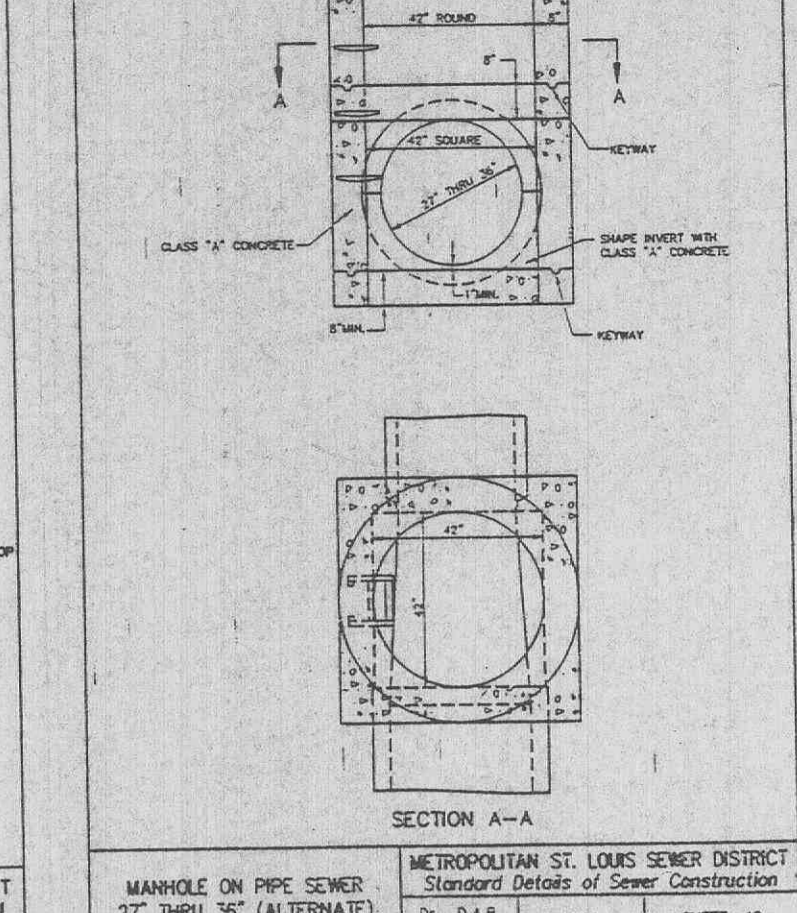
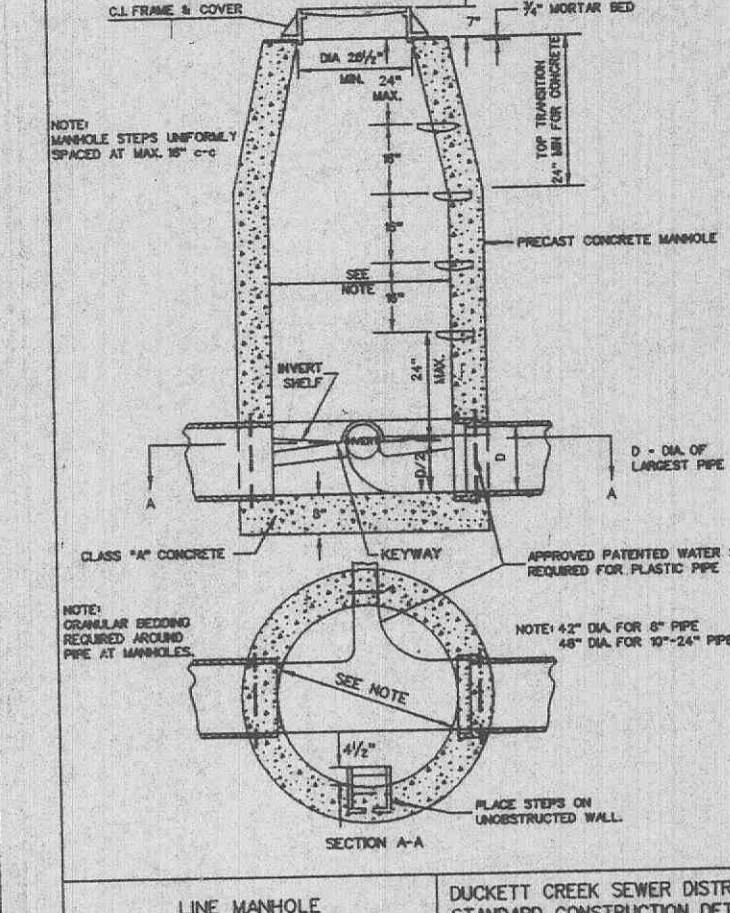
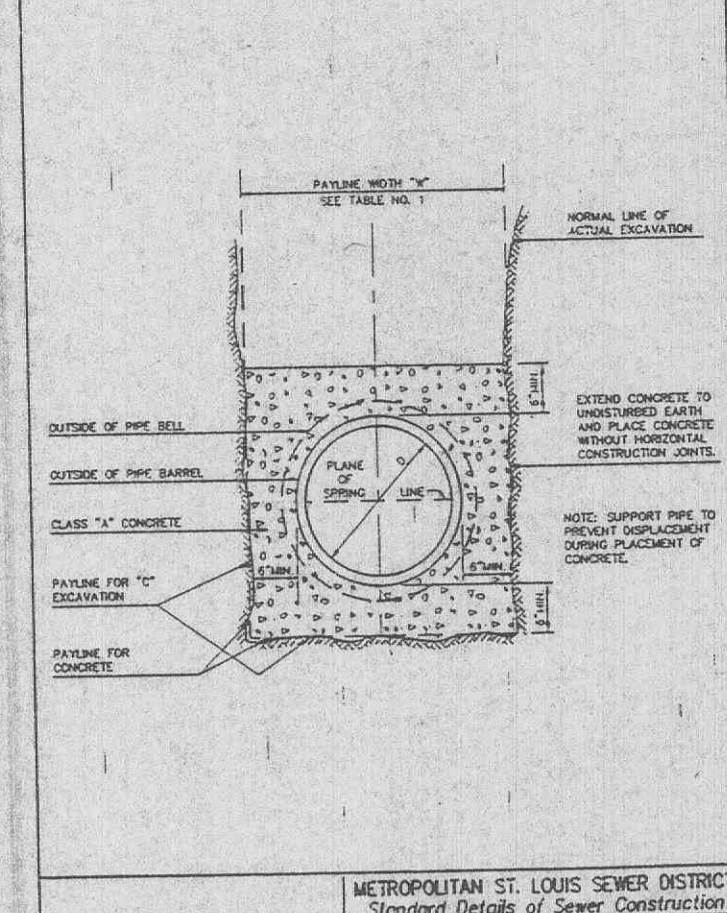
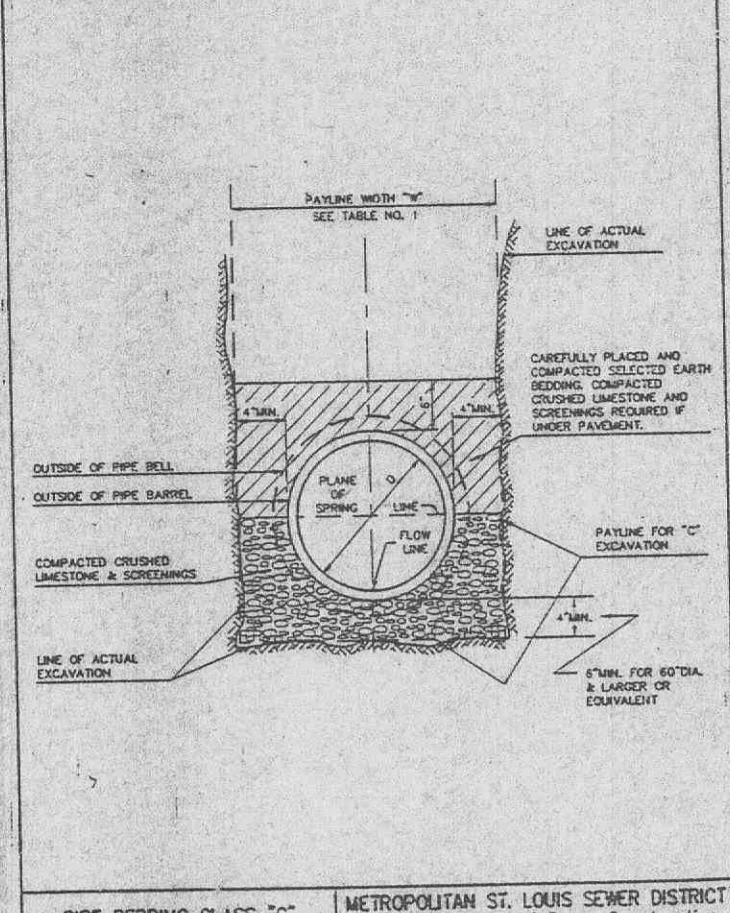
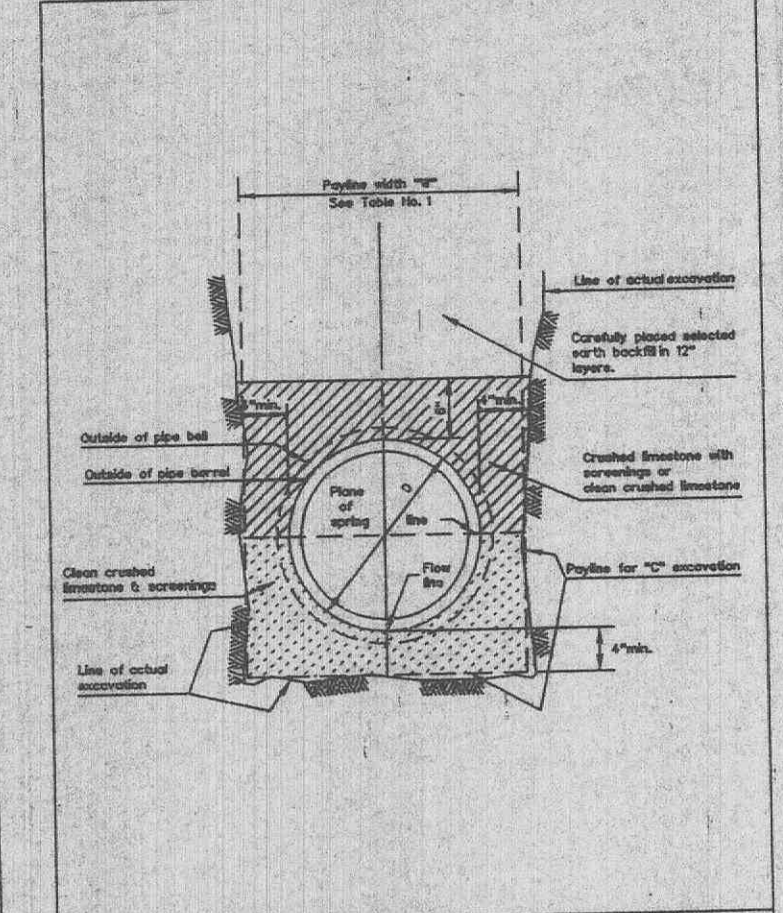

BOMASADA GROUP
 VOLZ
 THE ENCLAVE AT WINGHAVEN APARTMENTS
 CONSTRUCTION DETAILS
 Design By: D.A.L.
 Drawn By: A.L.F.
 10-29-92