

LOCKING DEVICE FOR TYPE "T" LOCK TYPE MANHOLE COVER
 METROPOLITAN ST. LOUIS SEWER DISTRICT
 Standard Details of Sewer Construction
 D. RW/SAM Ch. J.C.K. 2000 SHEET 55

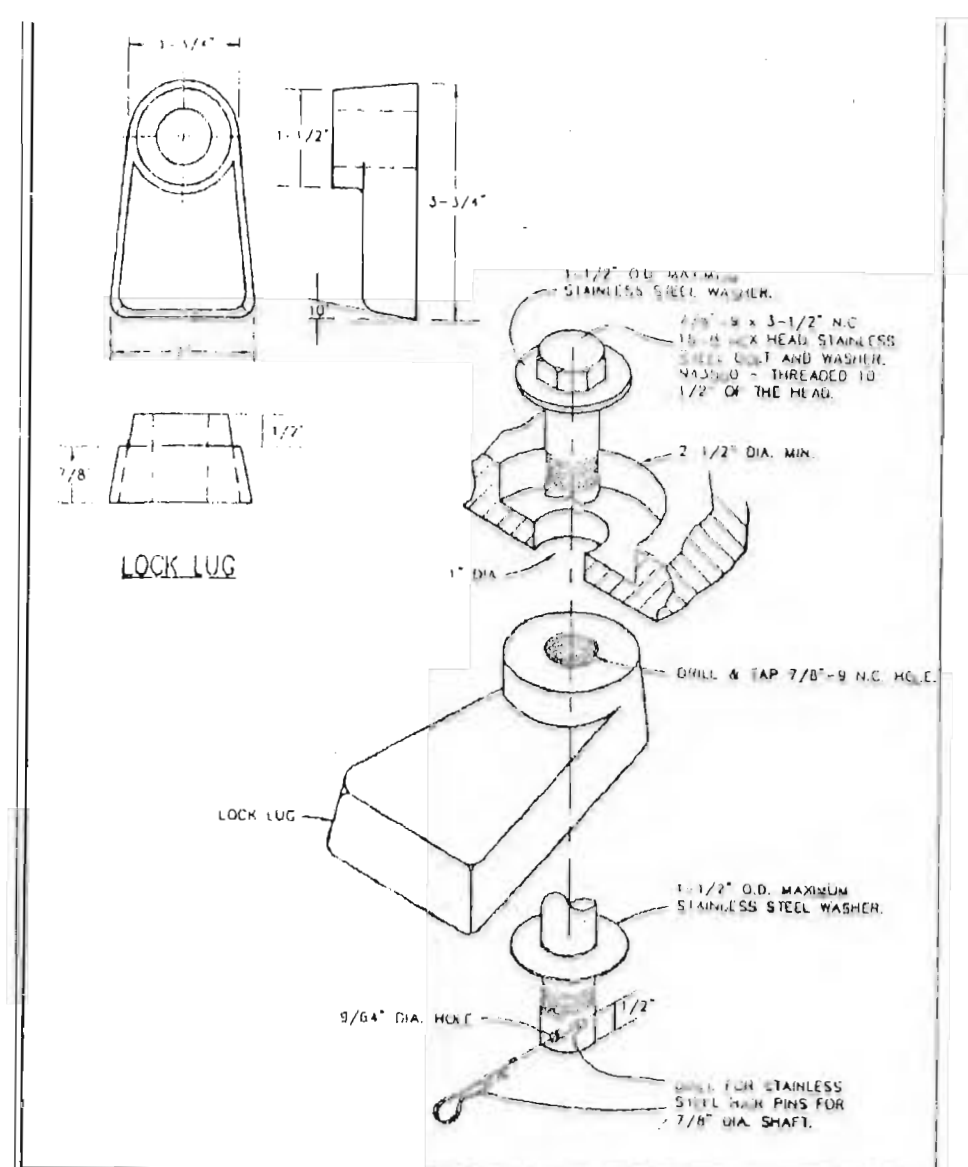

LOCKING DEVICE FOR TYPE "N" LOCK TYPE MANHOLE COVER
 METROPOLITAN ST. LOUIS SEWER DISTRICT
 Standard Details of Sewer Construction
 D. RW/SAM Ch. J.C.K. 2000 SHEET 56

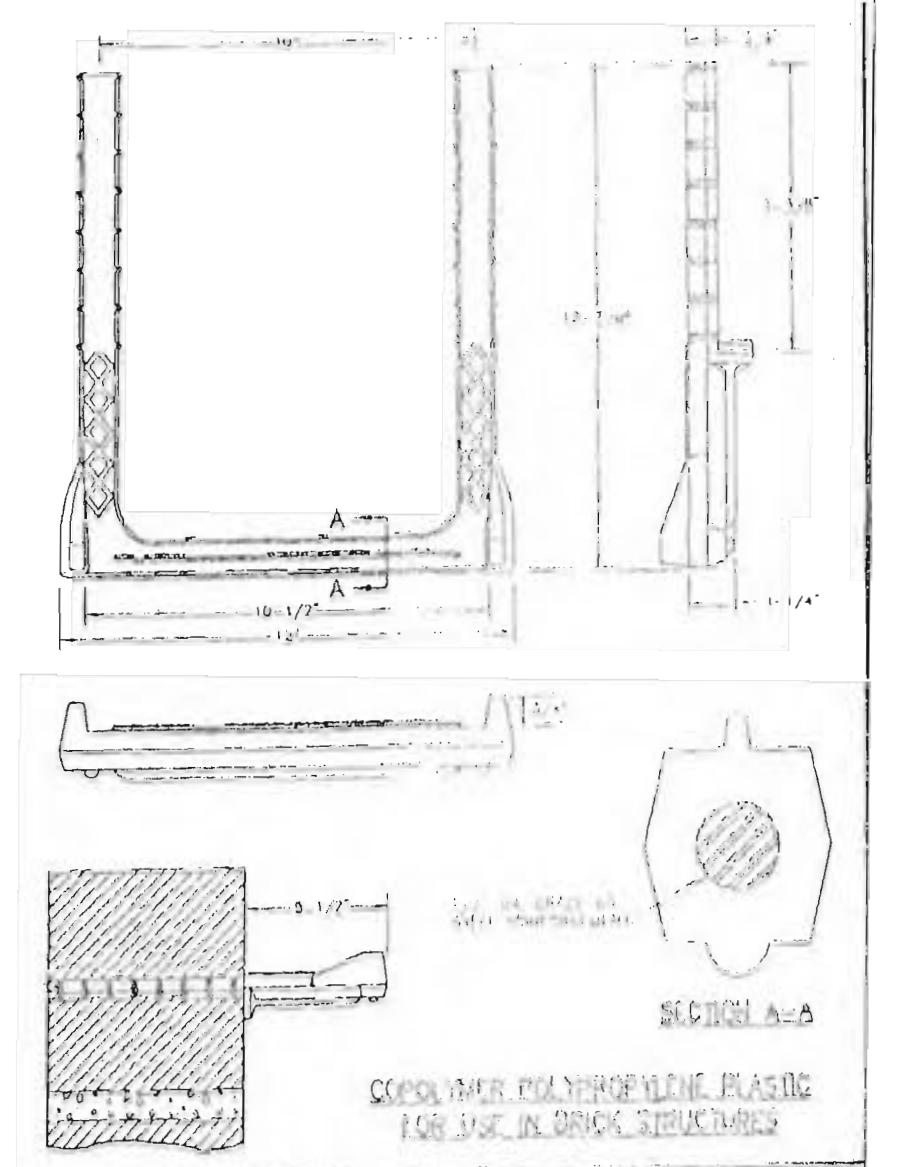

PSI-B MANHOLE STEP INTO JOINT
 METROPOLITAN ST. LOUIS SEWER DISTRICT
 Standard Details of Sewer Construction
 D. RW/SAM Ch. J.C.K. 2000 SHEET 57

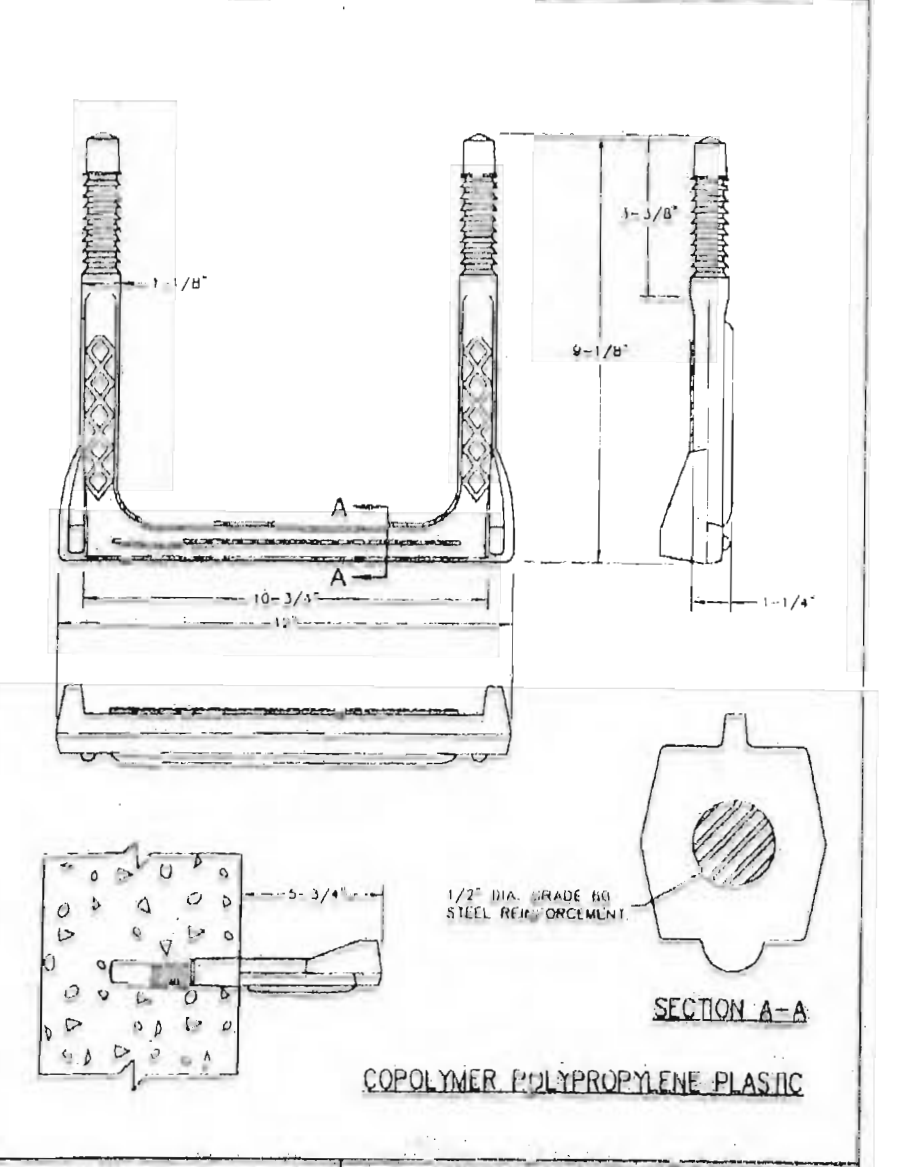

MANHOLE STEP FOR PRECAST & CAST-IN-PLACE MANHOLE
 METROPOLITAN ST. LOUIS SEWER DISTRICT
 Standard Details of Sewer Construction
 D. RW/SAM Ch. J.C.K. 2000 SHEET 58

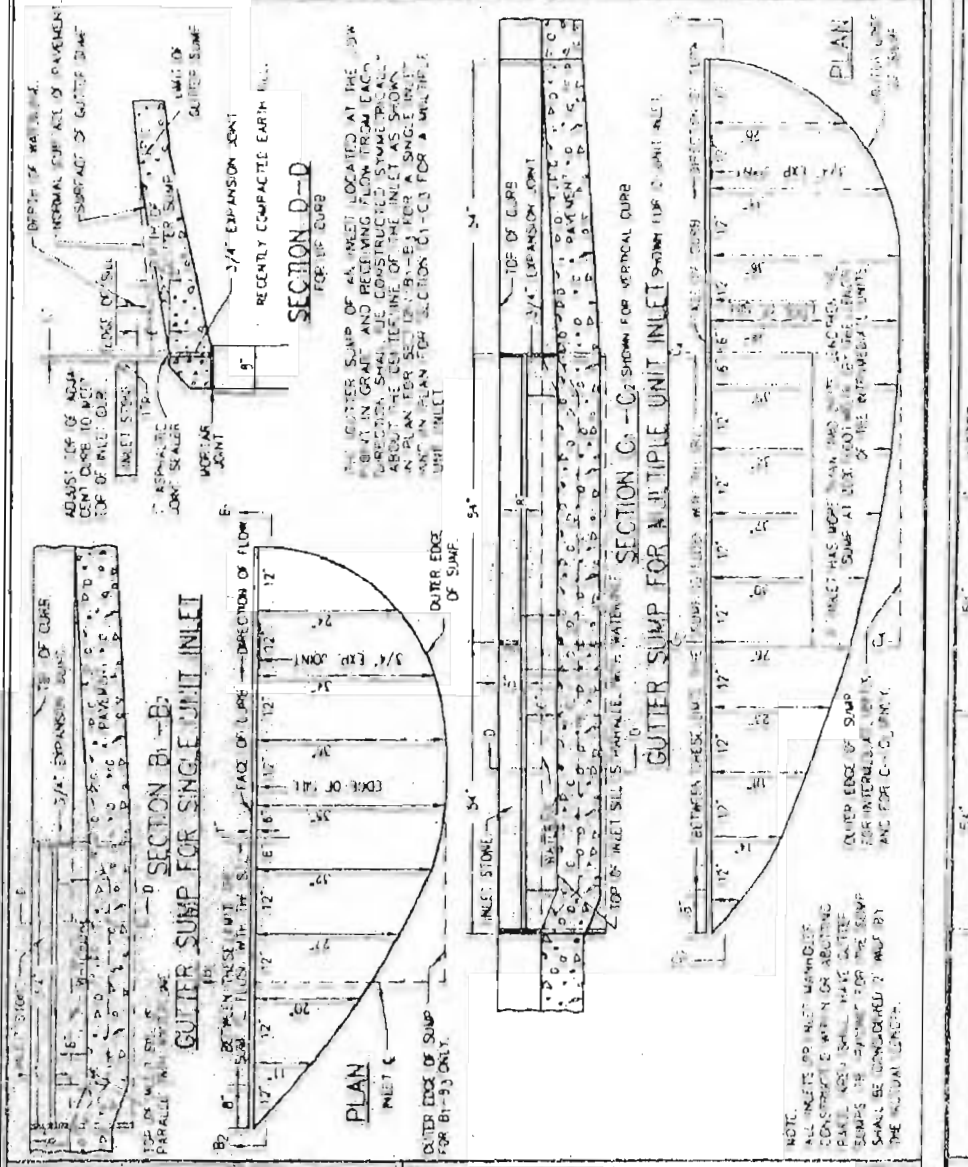

GUTTER SUMPS FOR VERTICAL CURB
 METROPOLITAN ST. LOUIS SEWER DISTRICT
 Standard Details of Sewer Construction
 D. RW/SAM Ch. J.C.K. 2000 SHEET 59

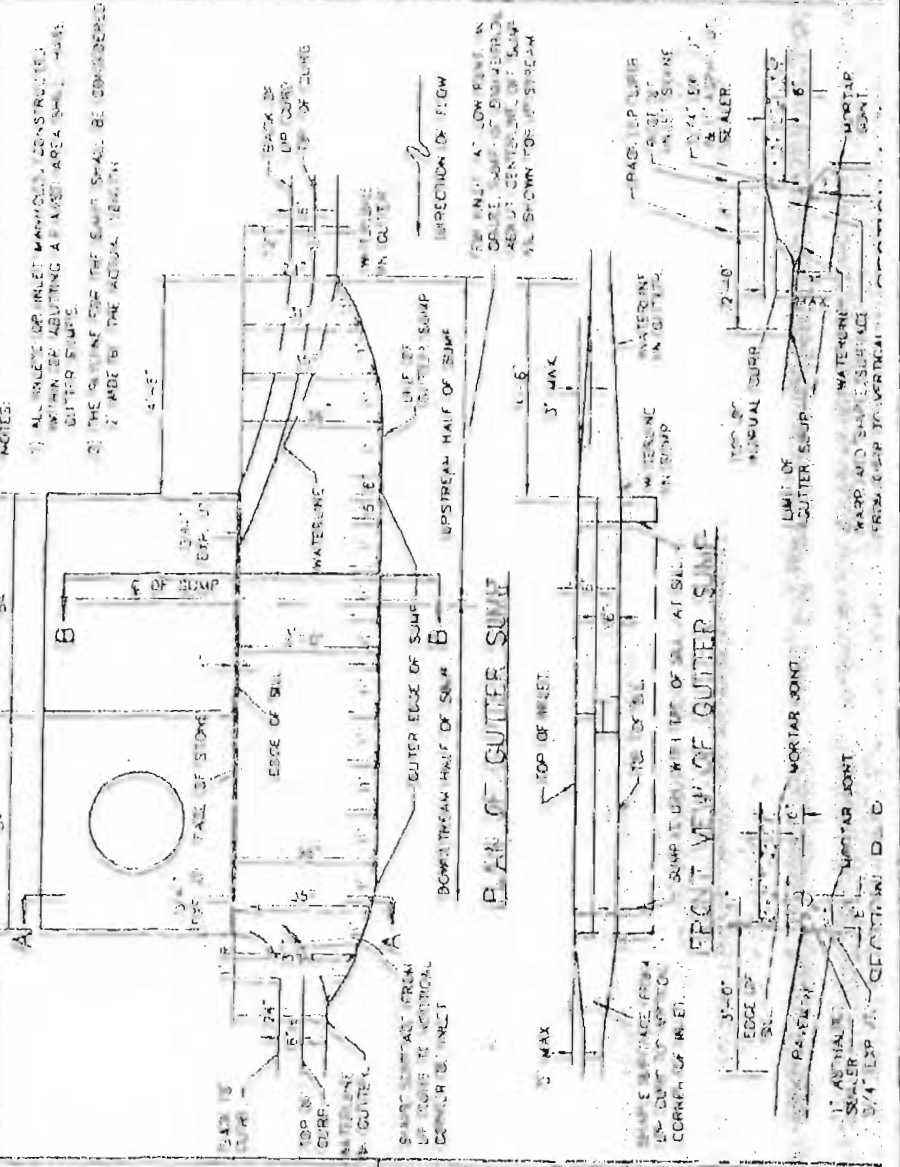

GUTTER SUMP FOR LIP CURB
 METROPOLITAN ST. LOUIS SEWER DISTRICT
 Standard Details of Sewer Construction
 D. RW/SAM Ch. J.C.K. 2000 SHEET 60

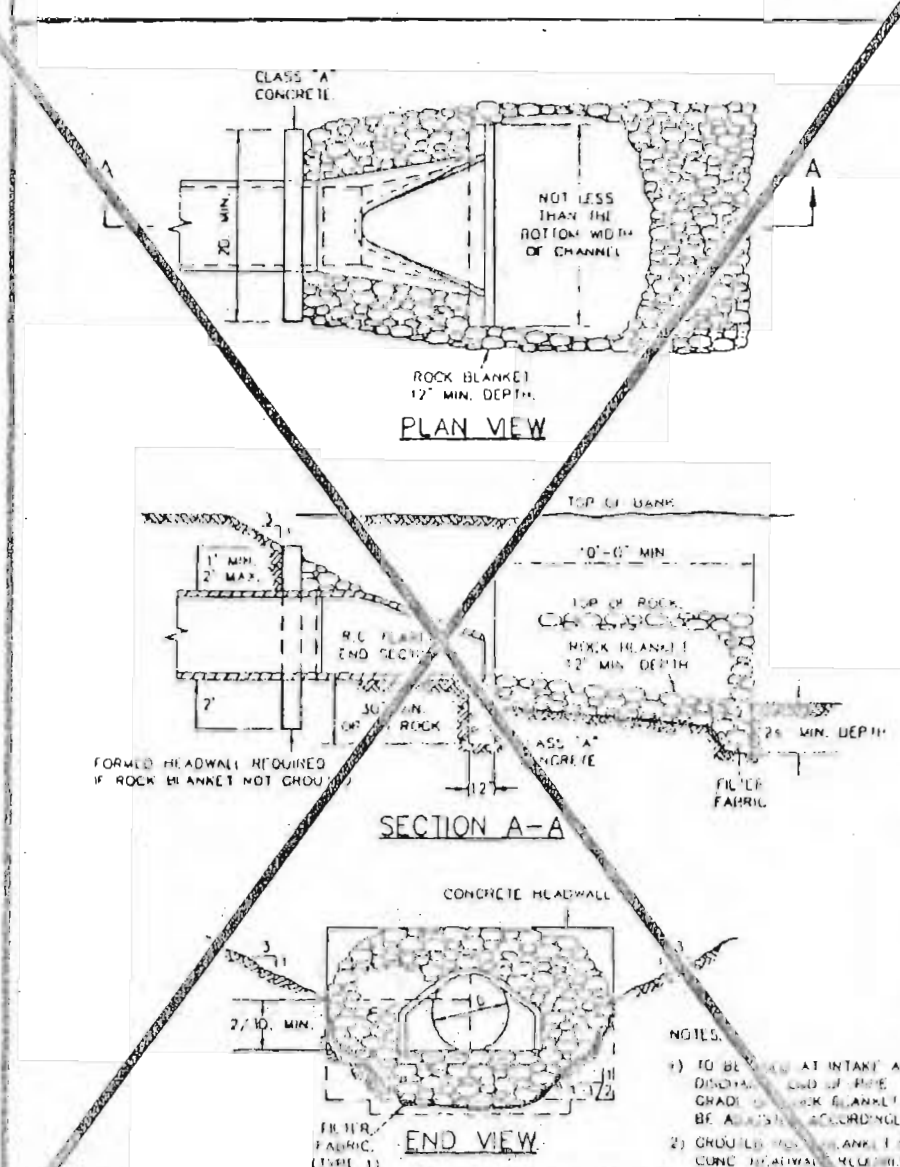

FLARED END SECTION
 METROPOLITAN ST. LOUIS SEWER DISTRICT
 Standard Details of Sewer Construction
 D. RW/SAM Ch. J.C.K. 2000 SHEET 61

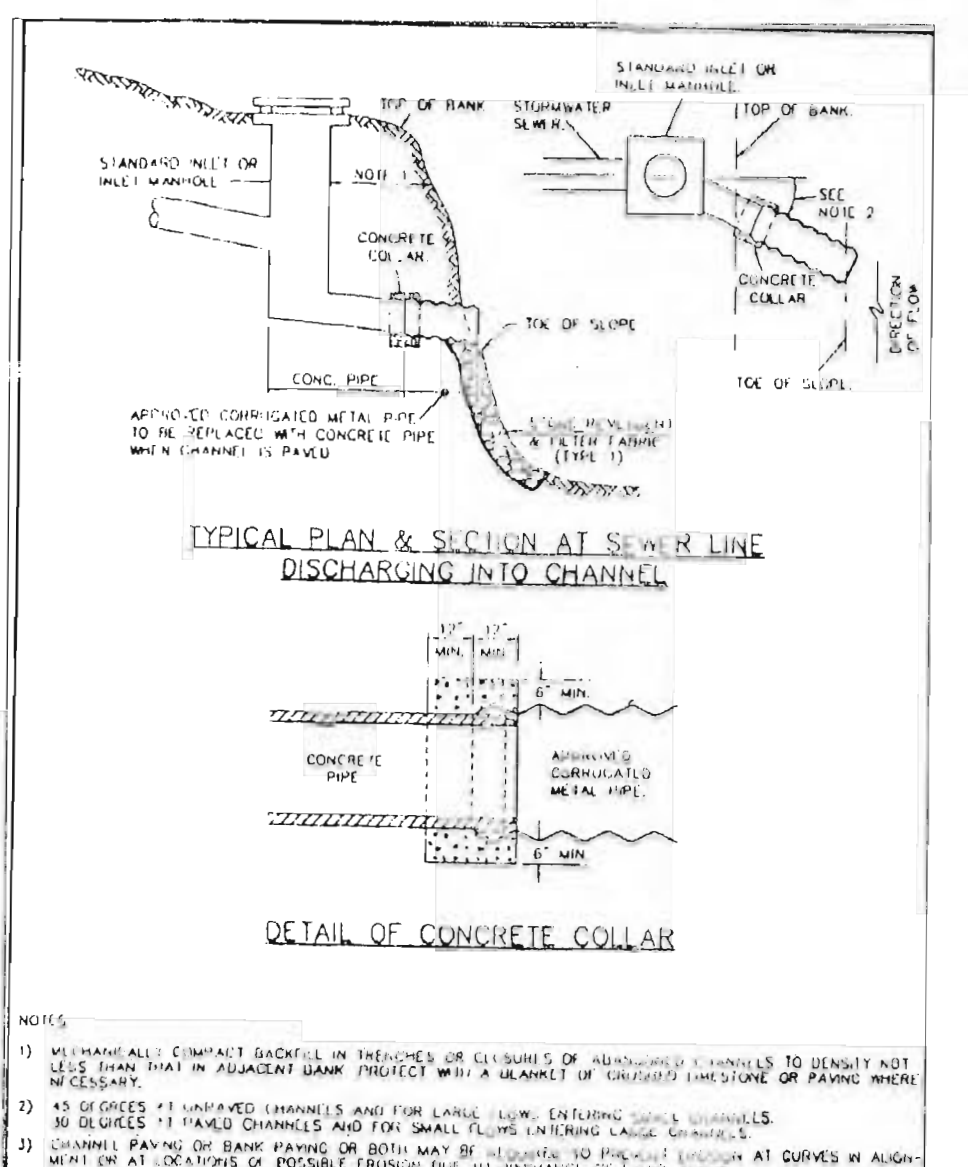

TYPICAL PLAN & SECTION AT SEWER LINE DISCHARGING INTO CHANNEL
 METROPOLITAN ST. LOUIS SEWER DISTRICT
 Standard Details of Sewer Construction
 D. RW/SAM Ch. J.C.K. 2000 SHEET 62

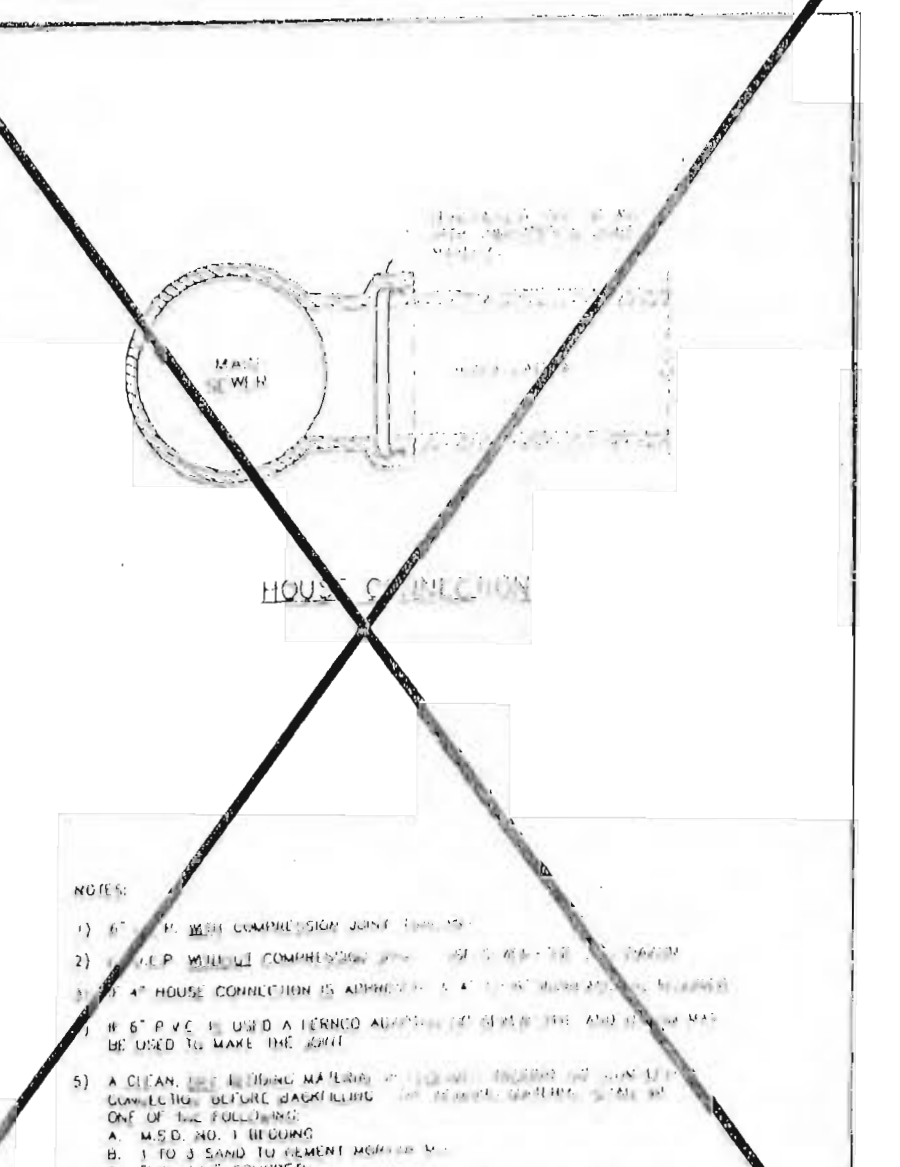

HOUSE CONNECTION
 METROPOLITAN ST. LOUIS SEWER DISTRICT
 Standard Details of Sewer Construction
 D. RW/SAM Ch. J.C.K. 2000 SHEET 63

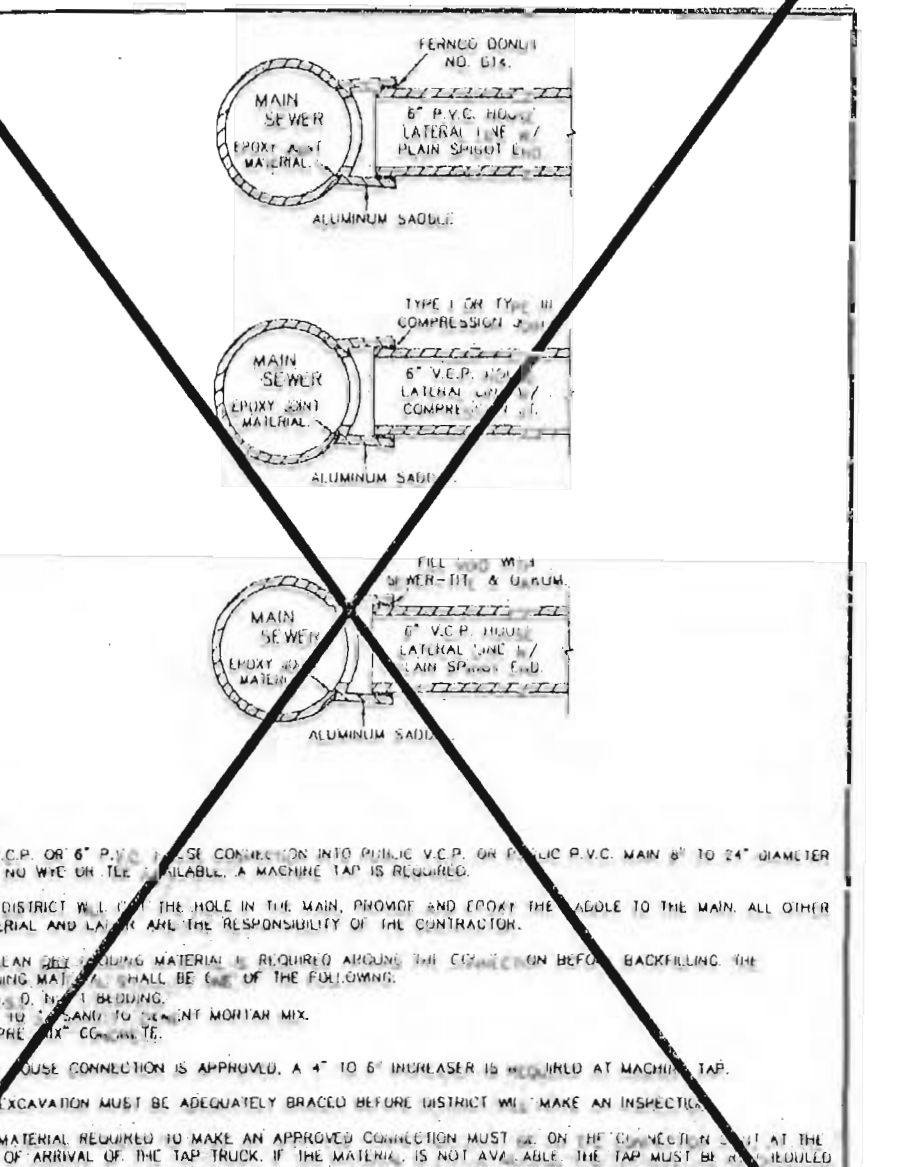

MACHINE TAP
 METROPOLITAN ST. LOUIS SEWER DISTRICT
 Standard Details of Sewer Construction
 D. RW/SAM Ch. J.C.K. 2000 SHEET 64

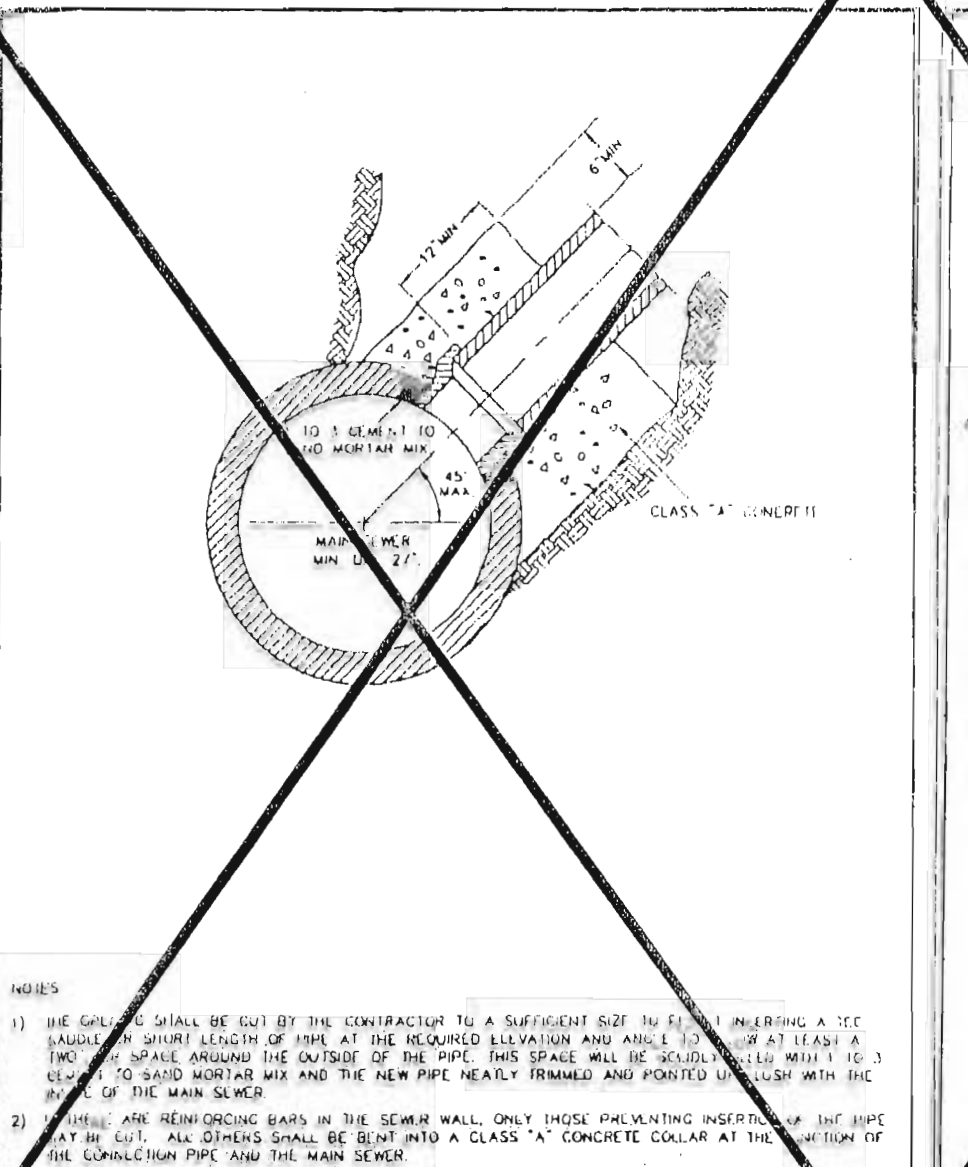

HOUSE CONNECTIONS ALLOWED BY TEE SADDLE
 METROPOLITAN ST. LOUIS SEWER DISTRICT
 Standard Details of Sewer Construction
 D. RW/SAM Ch. J.C.K. 2000 SHEET 65

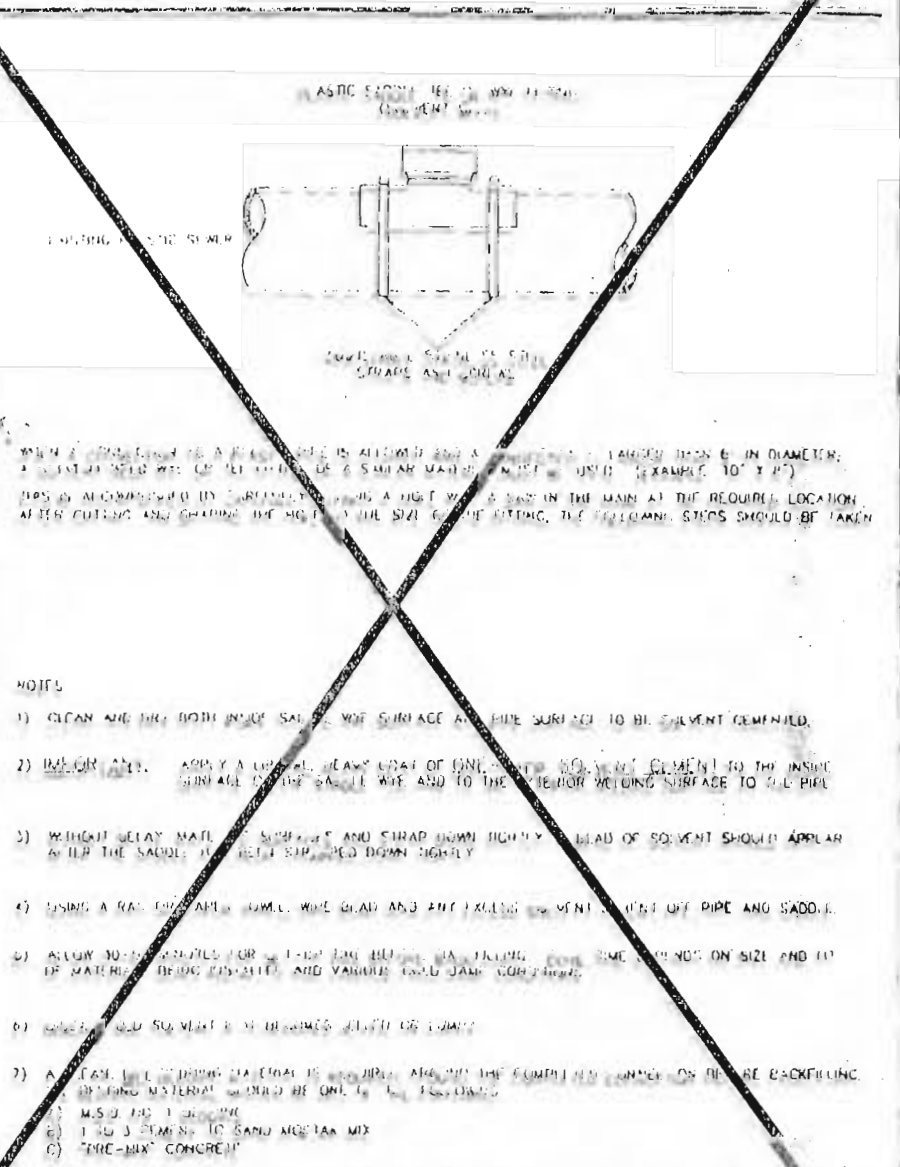

8\"/>
 METROPOLITAN ST. LOUIS SEWER DISTRICT
 Standard Details of Sewer Construction
 D. RW/SAM Ch. J.C.K. 2000 SHEET 66

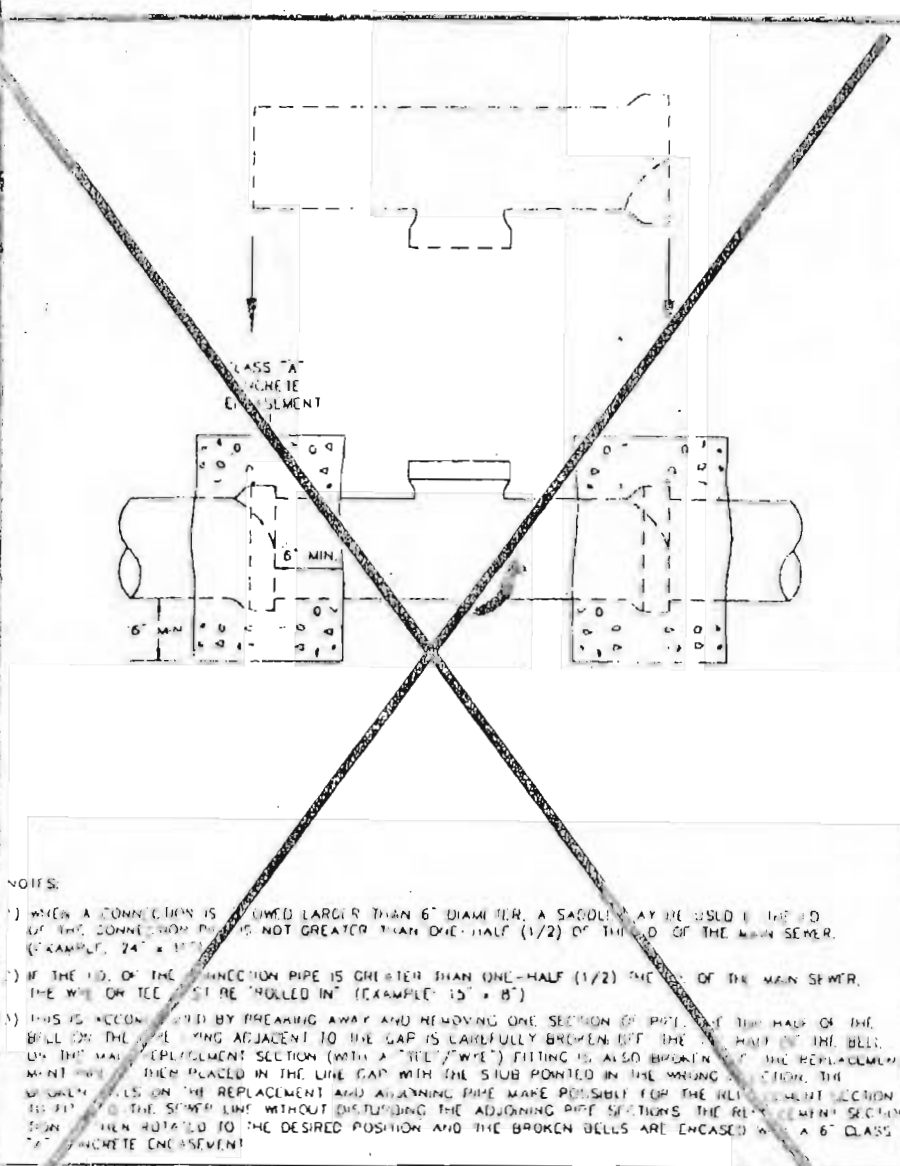

ROLL-IN (FOR EXISTING CLAY OR CONCRETE PIPE)
 METROPOLITAN ST. LOUIS SEWER DISTRICT
 Standard Details of Sewer Construction
 D. RW/SAM Ch. J.C.K. 2000 SHEET 67

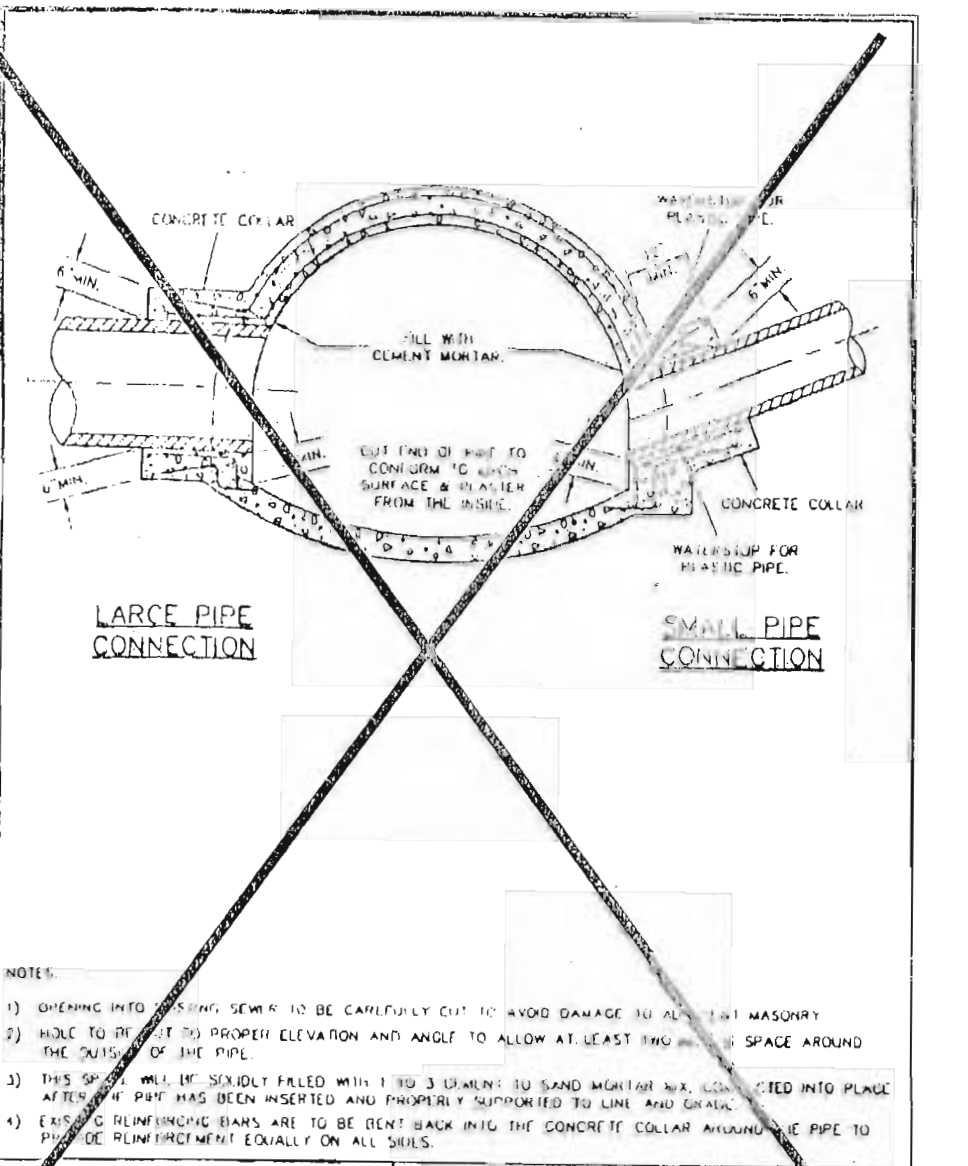

CONNECTIONS TO LARGE PIPES
 METROPOLITAN ST. LOUIS SEWER DISTRICT
 Standard Details of Sewer Construction
 D. RW/SAM Ch. J.C.K. 2000 SHEET 68

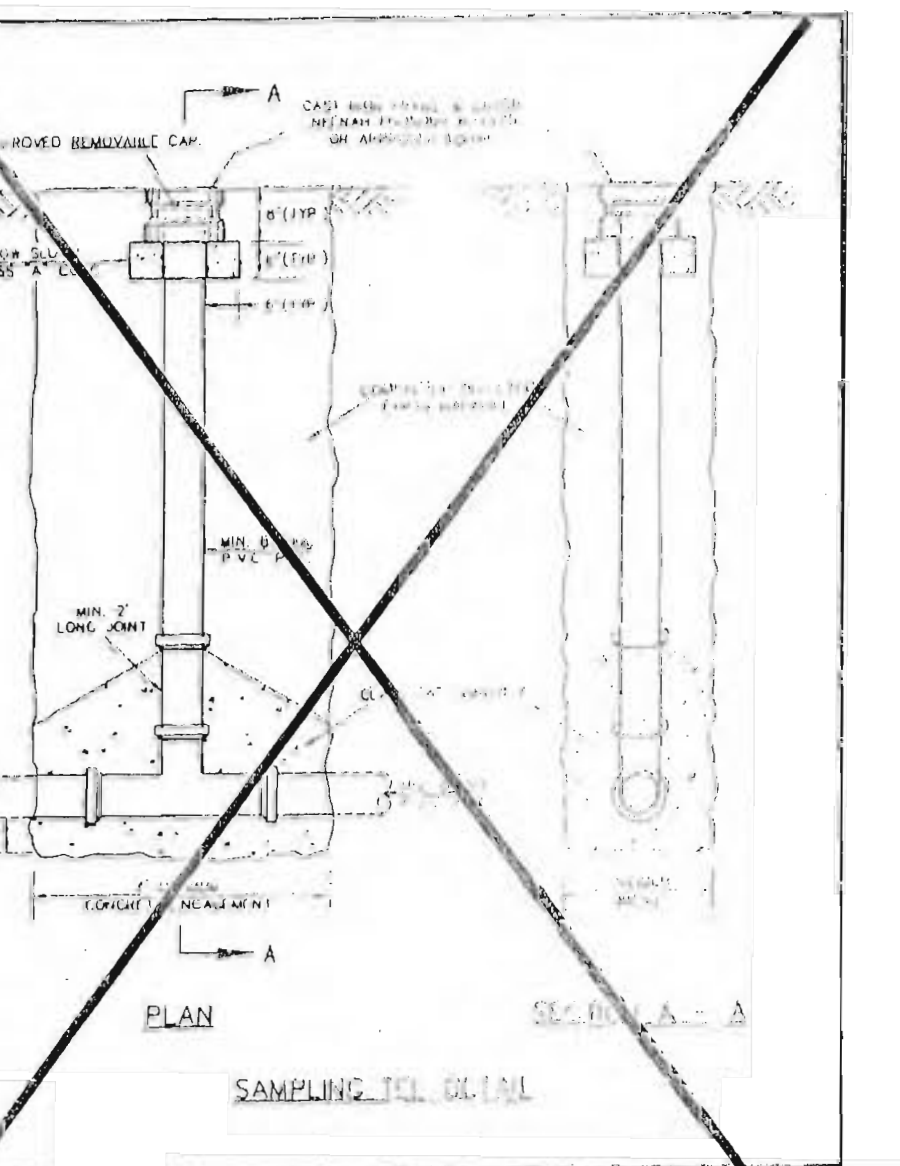

SAMPLING TEE
 METROPOLITAN ST. LOUIS SEWER DISTRICT
 Standard Details of Sewer Construction
 D. RW/SAM Ch. J.C.K. 2000 SHEET 69

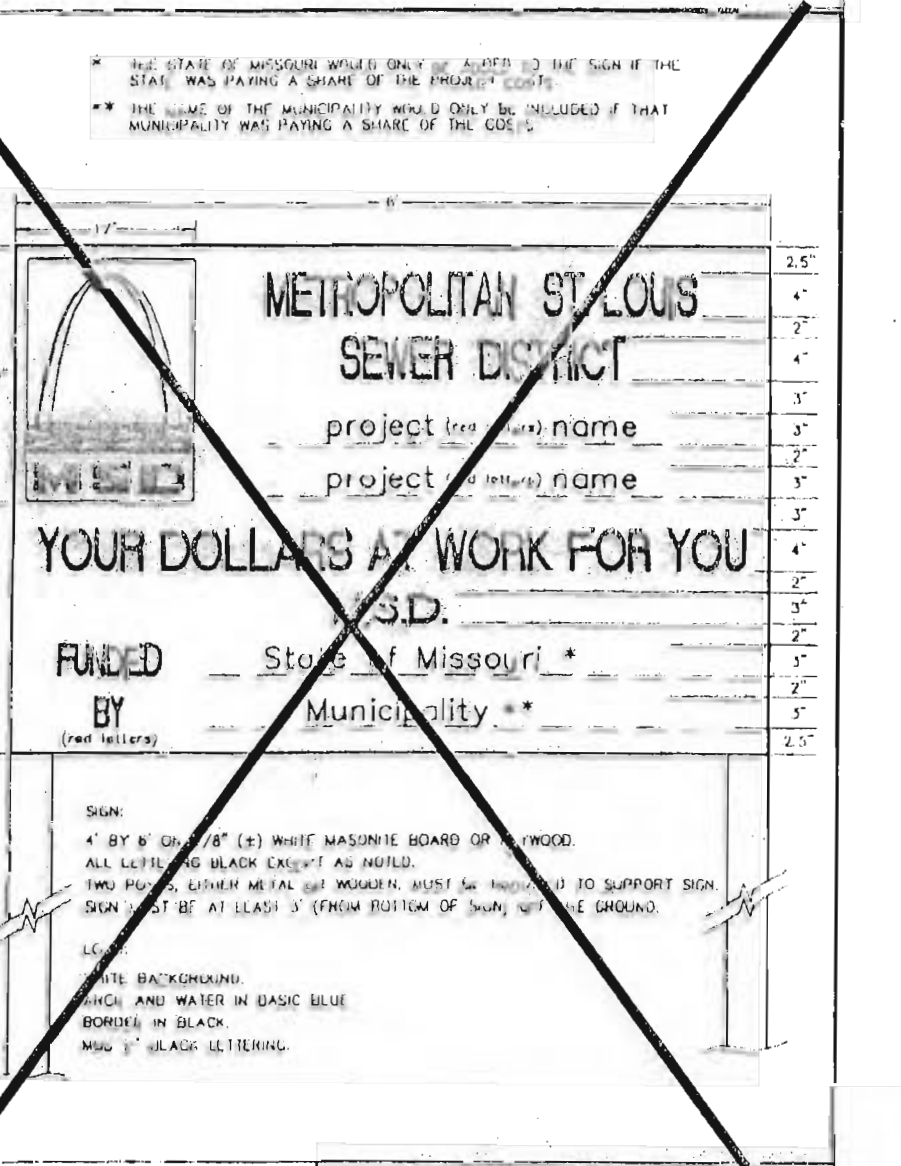

SIGNS
 METROPOLITAN ST. LOUIS SEWER DISTRICT
 Standard Details of Sewer Construction
 D. RW/SAM Ch. J.C.K. 2000 SHEET 70

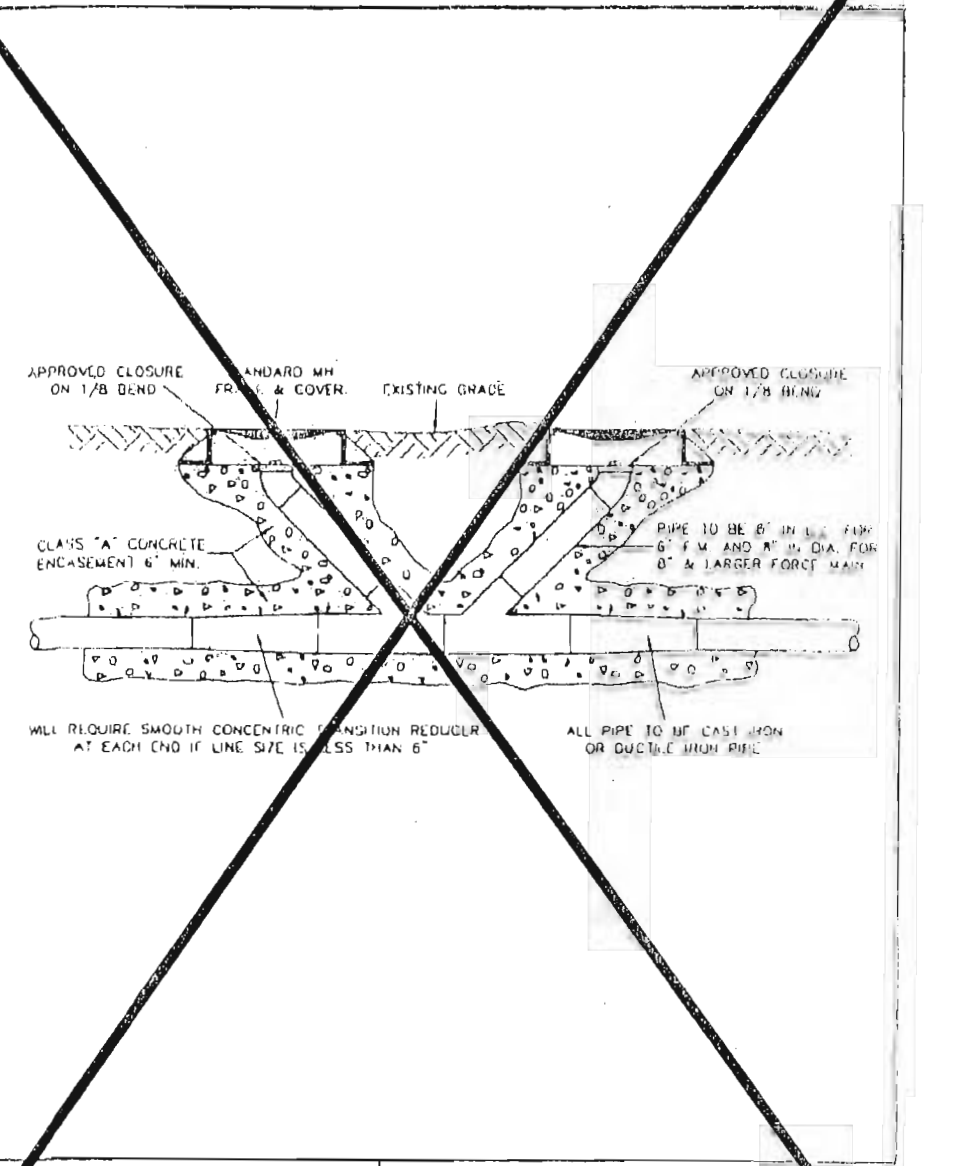

FORCE MAIN CLEANOUT (6\"/>
 METROPOLITAN ST. LOUIS SEWER DISTRICT
 Standard Details of Sewer Construction
 D. RW/SAM Ch. J.C.K. 2000 SHEET 71

NOTE: NO BRICK OR CAST IN PLACE STORM SEWER STRUCTURES WILL BE ALLOWED UNLESS PIPE IS 48\"/>

BASE MAP

REVISION NUMBER	DATE	DESCRIPTION
1	10-27-08	FIRST SUBMITTAL
2	12-14-08	REVISION PER I.C.S.D. & PASAD PER COMMENTS
3	12-18-08	REVISION PER ST. LOUIS COUNTY COMMENTS
4	11-25-07	REVISED PER ST. LOUIS COUNTY COMMENTS
5	12-18-07	REVISED PER I.C.S.D. & PASAD PER COMMENTS
6	01-28-07	REVISED PER I.C.S.D. & PASAD PER COMMENTS

PREPARED FOR:
CROSS DEVELOPMENT OF MISSOURI INC.
 1609 PROSPECT VILLAGE DR.
 LAKE ST. LOUIS, MO. 63367
 314-713-4054

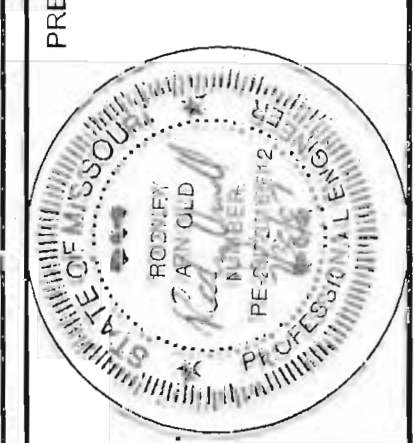

PREPARED BY:
STERLING & SURVEYORS, INC.
 ENGINEERS & SURVEYORS
 6605 NEW BAUNSGARTNER ROAD
 ST. LOUIS, MISSOURI 63129
 (314) 487-6400 FAX (314) 487-4514
 E-Mail: Sterling@sterling-eng-survey.com

PROJECT:	NO. 07 06 123
M.S.D.:	CD8
SHEET:	CD8
OF:	
DRAWN:	DESIGNED:
CHECKED:	
DETAILS	