

PRECAST CONCRETE STORMWATER STRUCTURES

MINIMUM DISTANCE FLOWLINE TO TOP OF STONE OR GRATE

PIPE ID NOMINAL INCHES	AREA INLET CIRCULAR BASE DIA.	2 GRATE INLET CIRCULAR BASE DIA.	SQUARE CIRCULAR BASE DIA.	SINGLE STREET INLET CIRCULAR BASE DIA.
12"	45"	36"	31"	41"
15"	48"	41"	34"	44"
18"	52"	44"	37"	48"
21"	55"	47"	40"	51"
24"	58"	51"	44"	54"
27"	70"	71"	NA	81"
30"	82"	74"	NA	85"
33"	85"	77"	NA	88"

(SEE SHEET 32 FOR DETAIL) (SEE SHEET 33 FOR DETAIL) (SEE SHEET 34 FOR DETAIL)

NOTE 1: 48" DIA. BASE REQUIRES 1" HIGH TRANSITION SECTION TO 42" DIA. SIMILAR TO "ADAPTER RING" SHEET 32.
NOTE 2: 80" DIA. BASE REQUIRES 24" HIGH CONCRETE REDUCER TRANSITION TO 42" DIA. SIMILAR TO "ADAPTER RING" SHEET 32.

PRECAST CONCRETE STORMWATER STRUCTURES
METROPOLITAN ST. LOUIS SEWER DISTRICT
Standard Details of Sewer Construction
Dr. J.L.G. CH. J.C.K. SEPT. 1990 SHEET 31

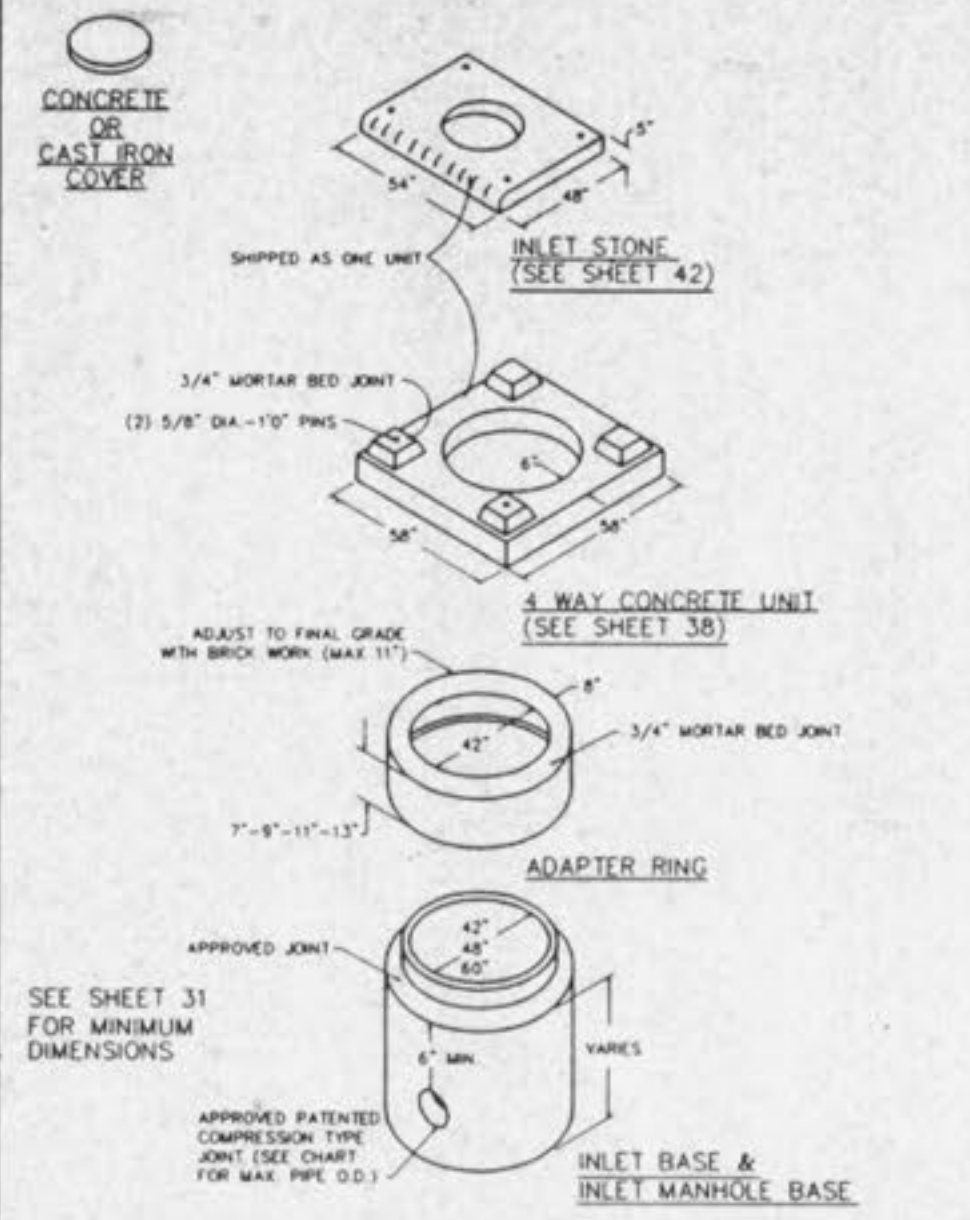

AREA INLET PRECAST CONCRETE
METROPOLITAN ST. LOUIS SEWER DISTRICT
Standard Details of Sewer Construction
Dr. J.L.G. CH. J.C.K. APRIL 1992 SHEET 32

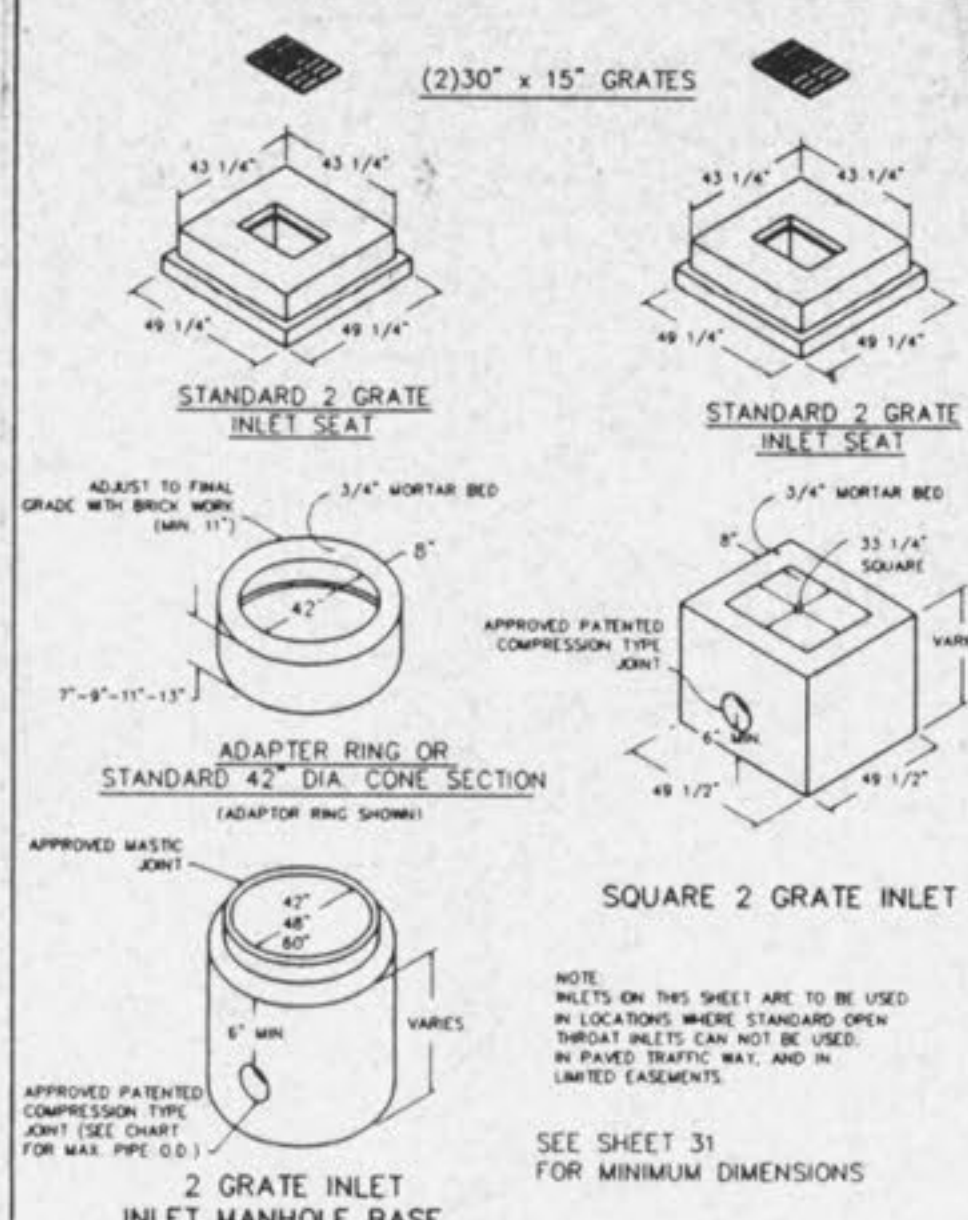

2 GRATE INLETS PRECAST CONCRETE
METROPOLITAN ST. LOUIS SEWER DISTRICT
Standard Details of Sewer Construction
Dr. J.L.G. CH. J.C.K. APRIL 1992 SHEET 33

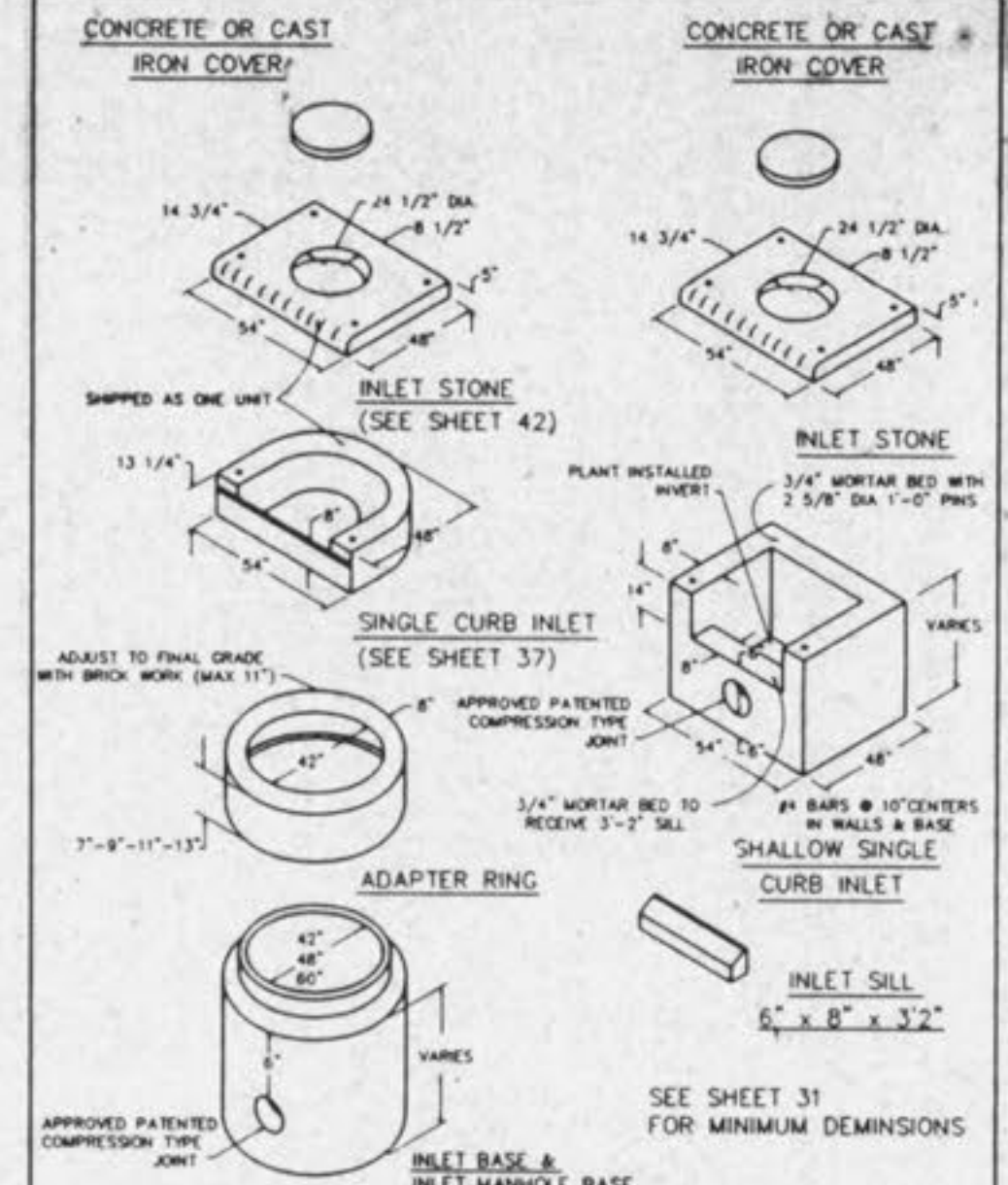

SINGLE STREET INLETS PRECAST CONCRETE
METROPOLITAN ST. LOUIS SEWER DISTRICT
Standard Details of Sewer Construction
Dr. J.L.G. CH. J.C.K. APRIL 1991 SHEET 34

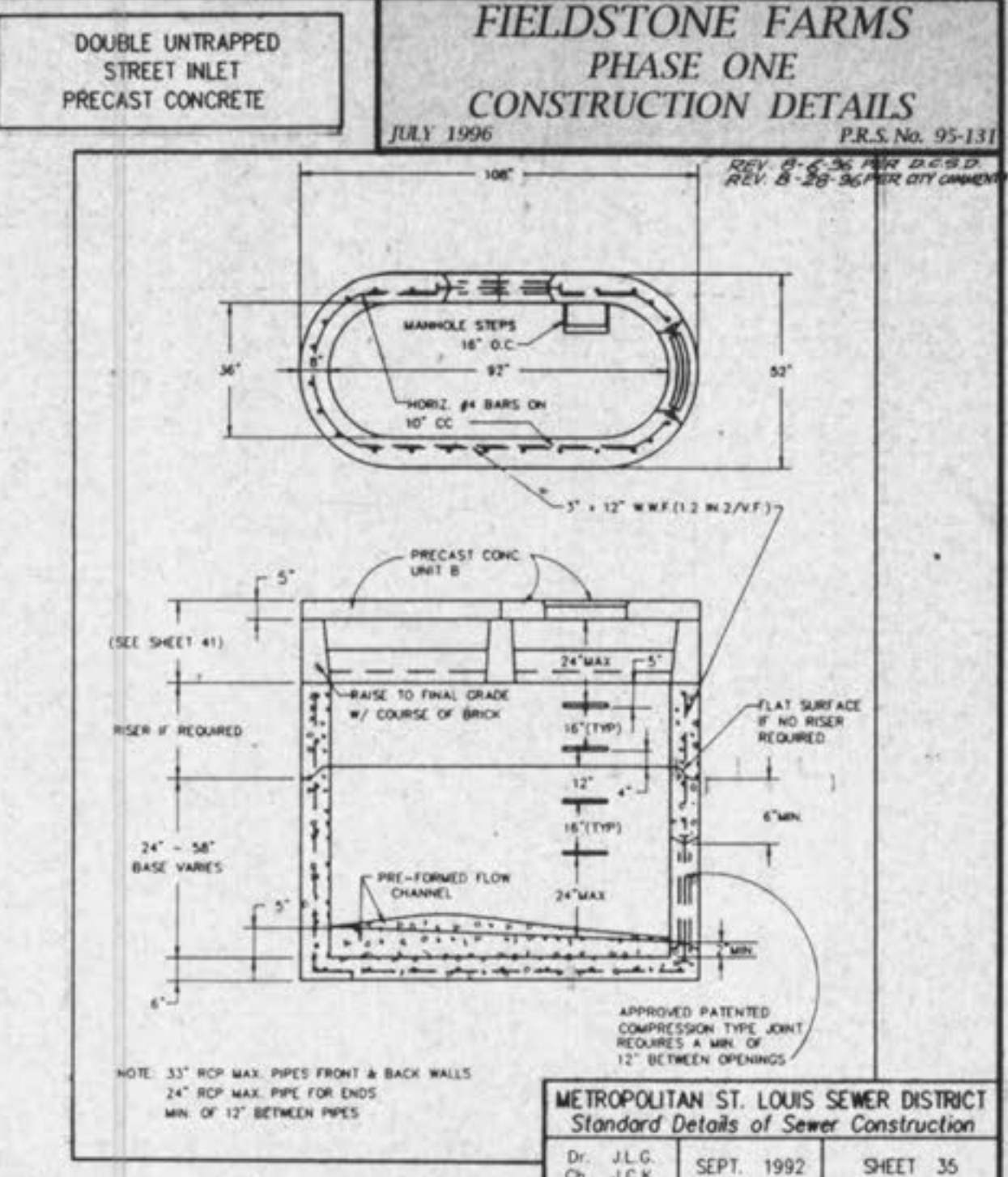

DOUBLE UNTRAPPED STREET INLET PRECAST CONCRETE
METROPOLITAN ST. LOUIS SEWER DISTRICT
Standard Details of Sewer Construction
Dr. J.L.G. CH. J.C.K. SEPT. 1992 SHEET 35

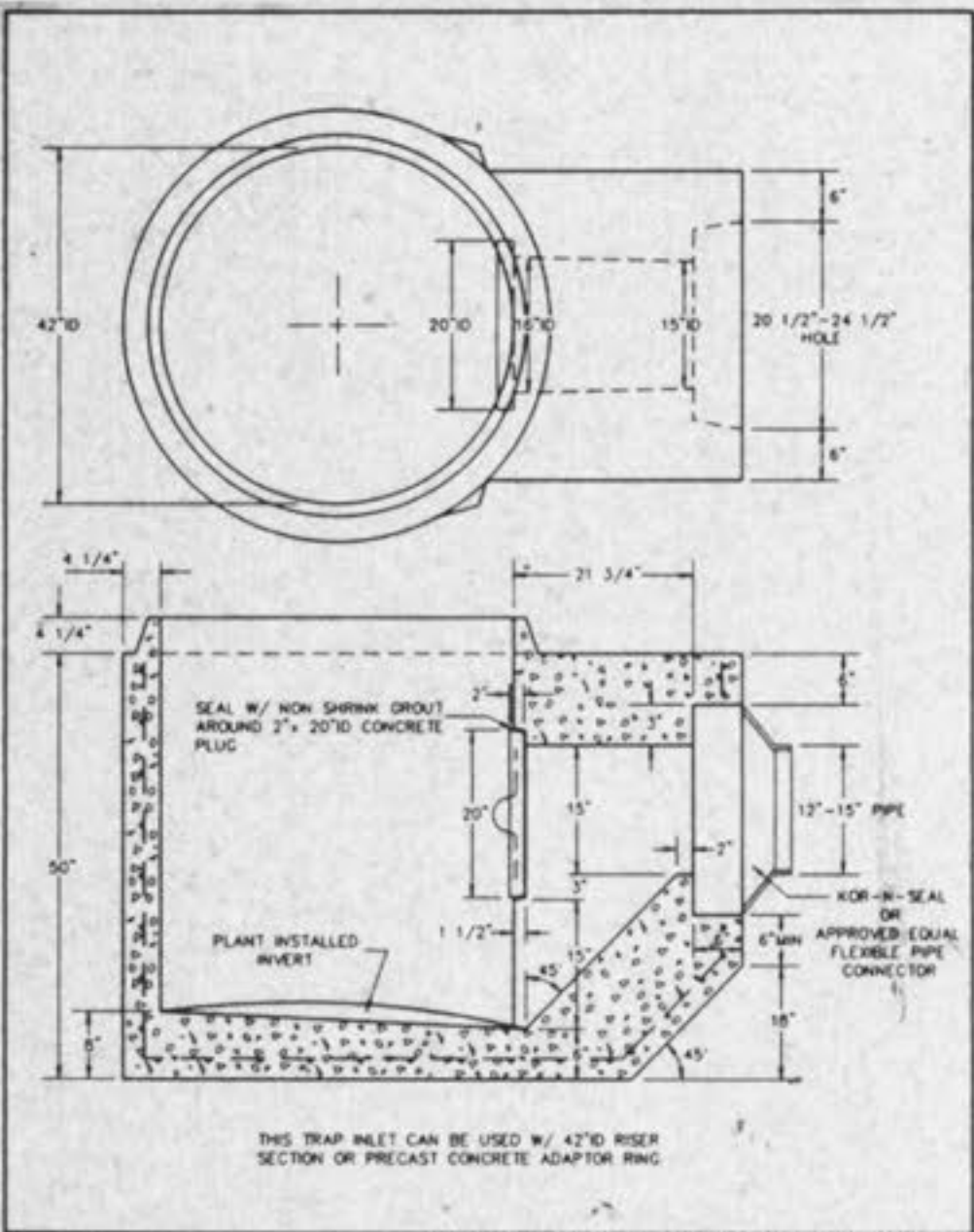

TRAPPED STREET INLET BASE PRECAST CONCRETE
METROPOLITAN ST. LOUIS SEWER DISTRICT
Standard Details of Sewer Construction
Dr. W.S.H. CH. J.C.K. 1992 SHEET 36

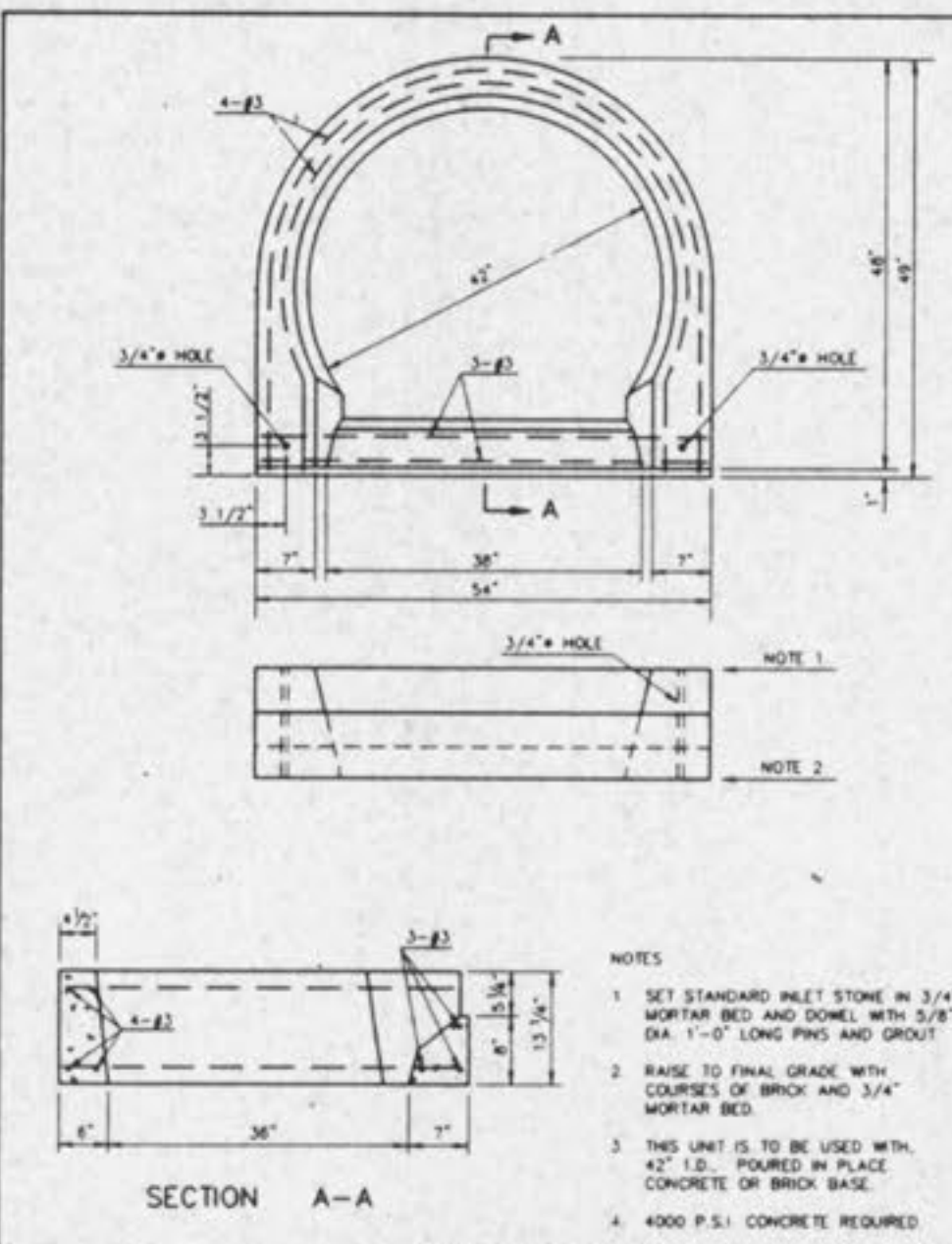

PRE-CAST CONCRETE UNIT FOR SINGLE STREET INLET
METROPOLITAN ST. LOUIS SEWER DISTRICT
Standard Details of Sewer Construction
Dr. W.S.H. CH. J.C.K. 1992 SHEET 37

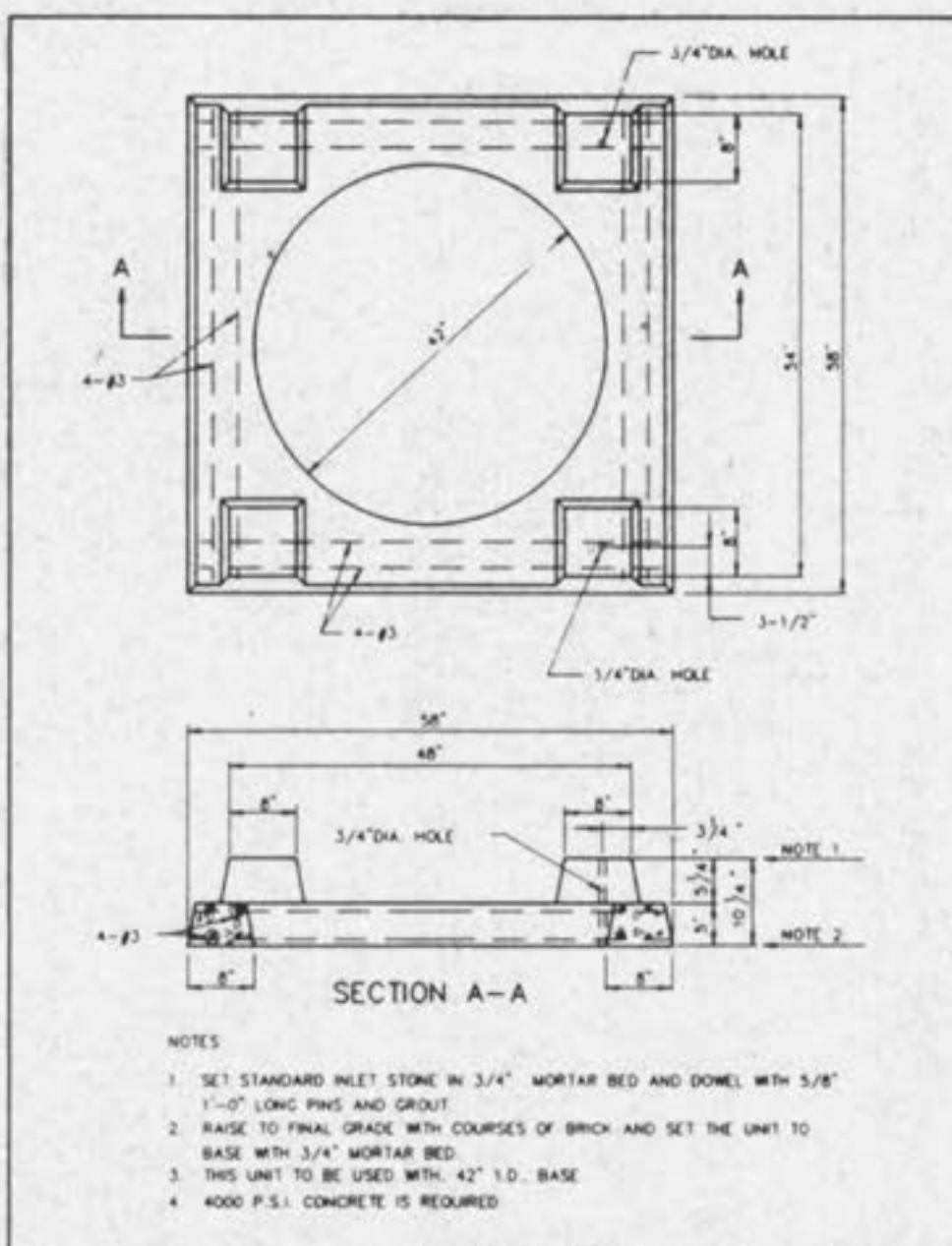

PRE-CAST CONCRETE UNIT FOR 4 WAY AREA INLET
METROPOLITAN ST. LOUIS SEWER DISTRICT
Standard Details of Sewer Construction
Dr. D.A.B. CH. J.C.K. 1992 SHEET 38

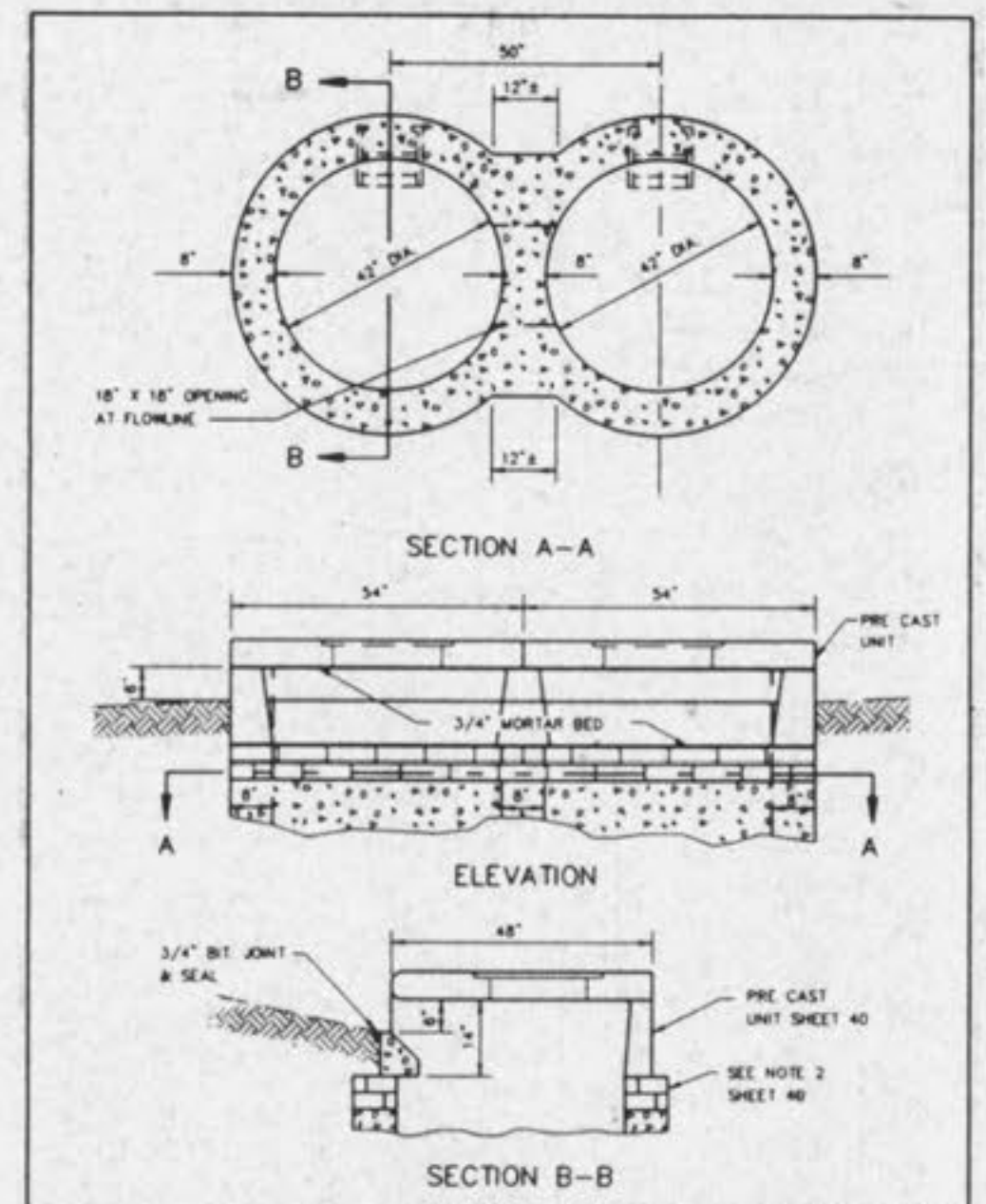

CONCRETE DOUBLE STREET INLET W/PRE-CAST CONCRETE UNIT A
METROPOLITAN ST. LOUIS SEWER DISTRICT
Standard Details of Sewer Construction
Dr. R.G.W. CH. J.C.K. 1992 SHEET 39

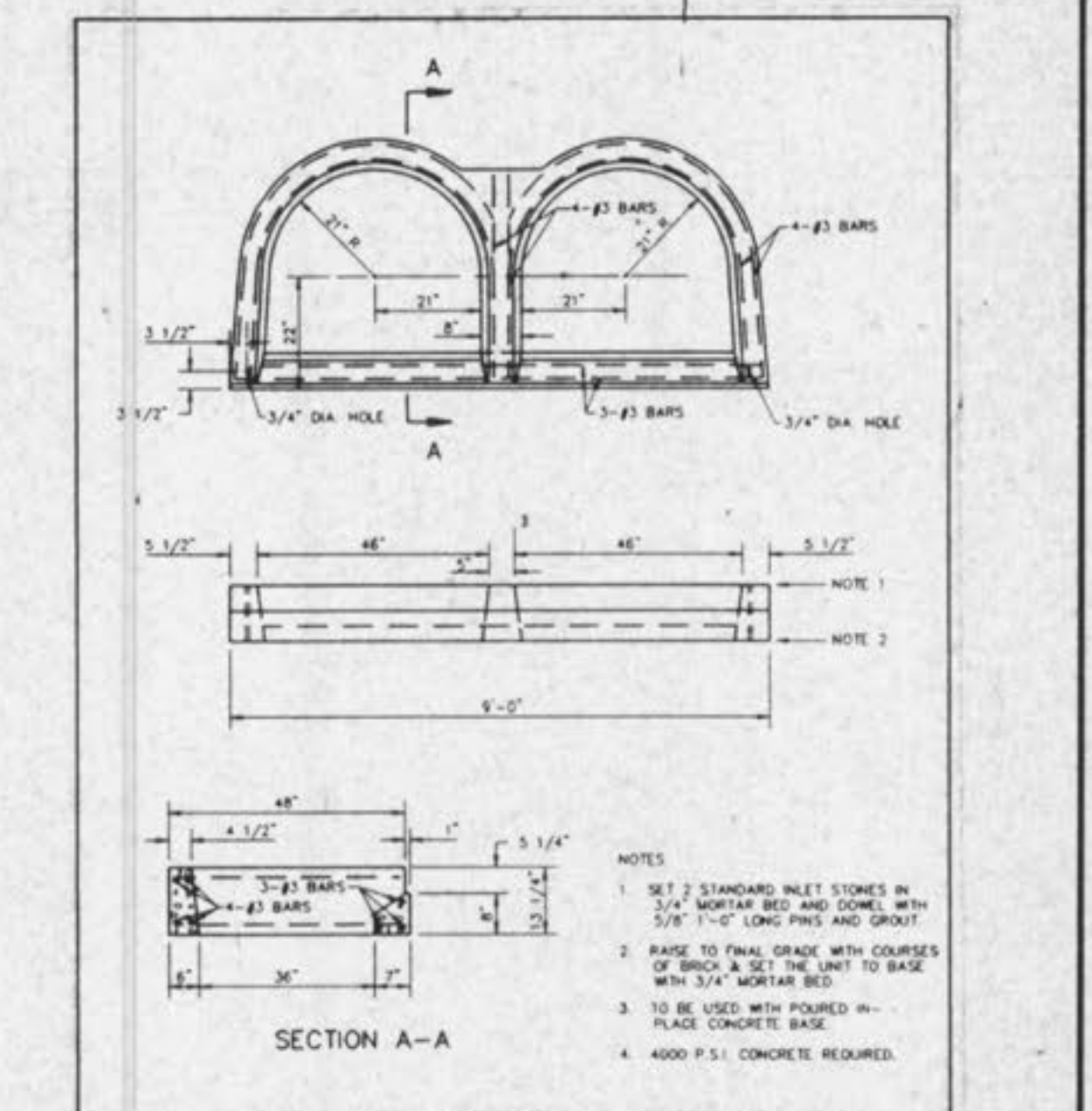

PRE-CAST CONCRETE UNIT A FOR STREET DOUBLE INLET
METROPOLITAN ST. LOUIS SEWER DISTRICT
Standard Details of Sewer Construction
Dr. R.G.W. CH. J.C.K. 1992 SHEET 40

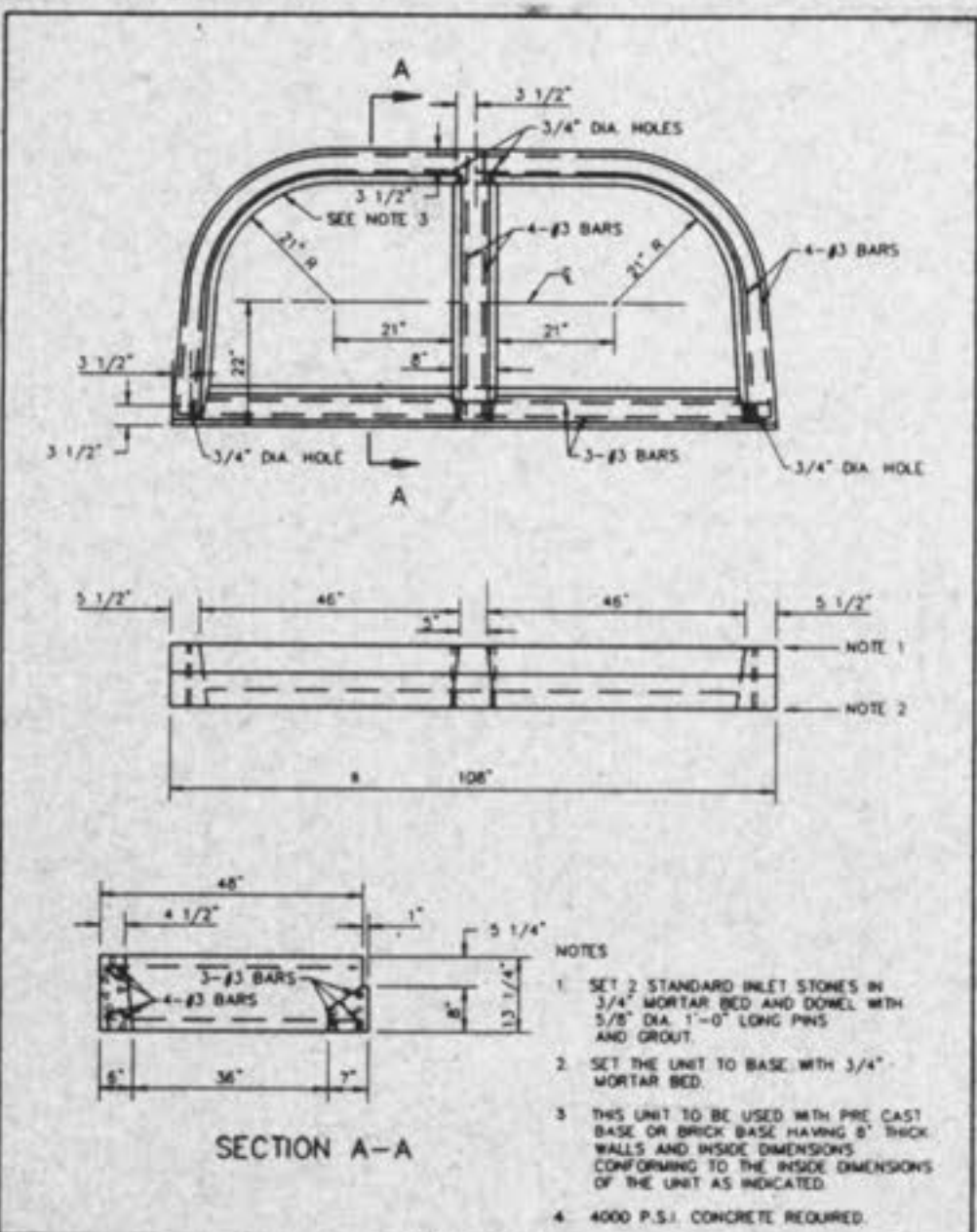

PRE-CAST CONCRETE UNIT B FOR STREET DOUBLE INLET
METROPOLITAN ST. LOUIS SEWER DISTRICT
Standard Details of Sewer Construction
Dr. R.G.W. CH. J.C.K. 1992 SHEET 41

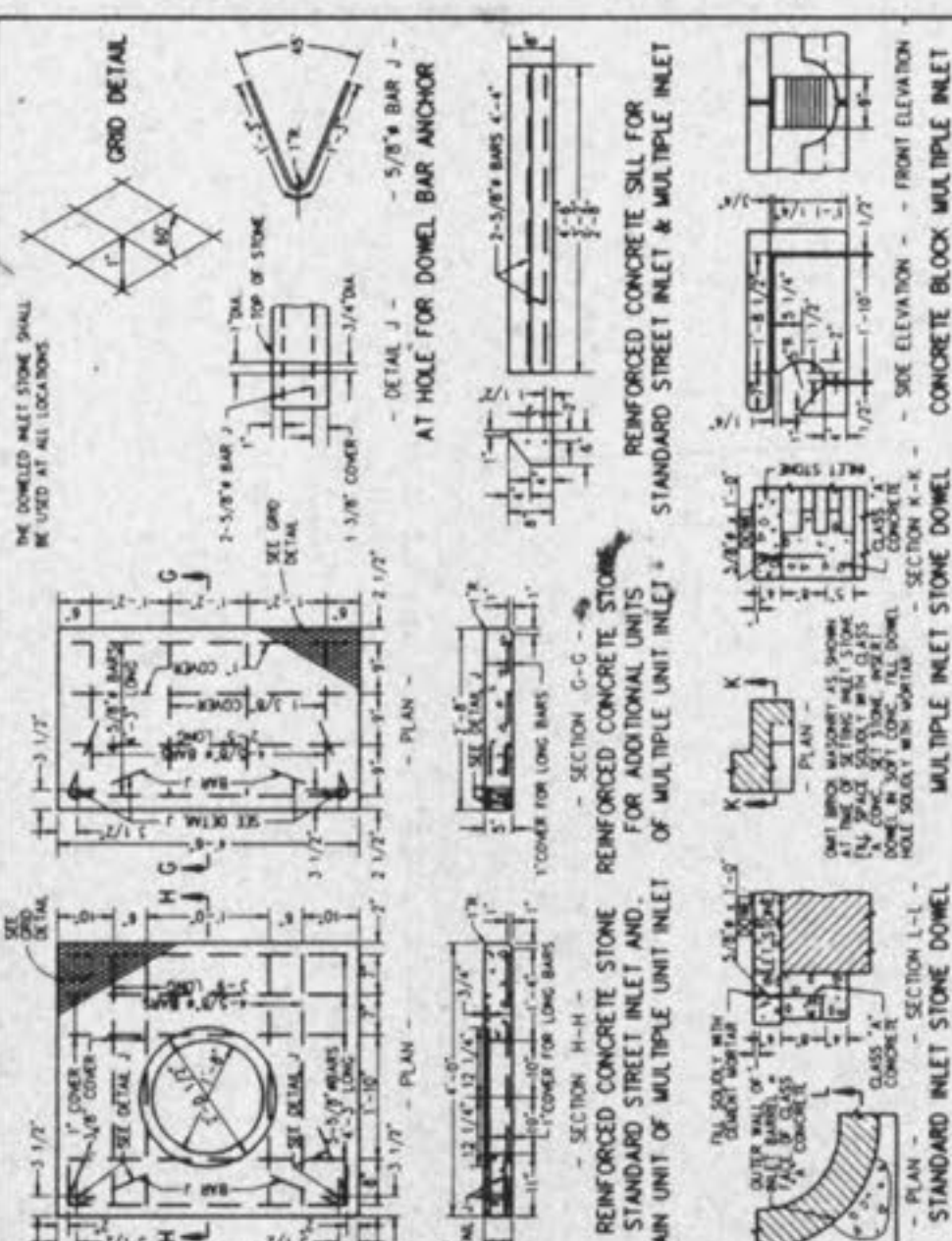

STANDARD - INLET STONES, BLOCKS & DESIGN DETAILS
METROPOLITAN ST. LOUIS SEWER DISTRICT
Standard Details of Sewer Construction
Dr. W.S.H. CH. J.C.K. 1992 SHEET 42

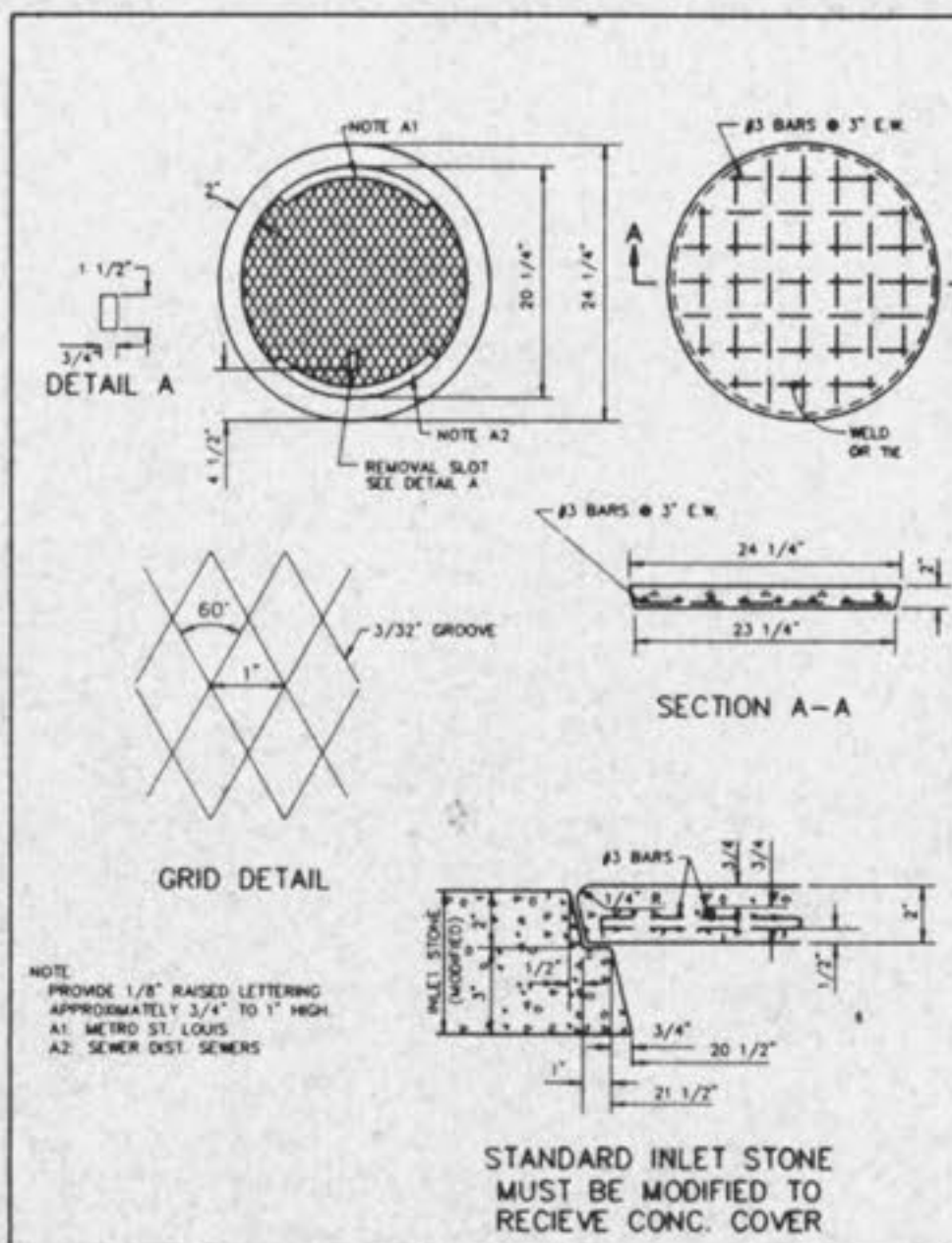

PRE-CAST CONCRETE INLET COVER
METROPOLITAN ST. LOUIS SEWER DISTRICT
Standard Details of Sewer Construction
Dr. R.G.W. CH. J.C.K. 1992 SHEET 43

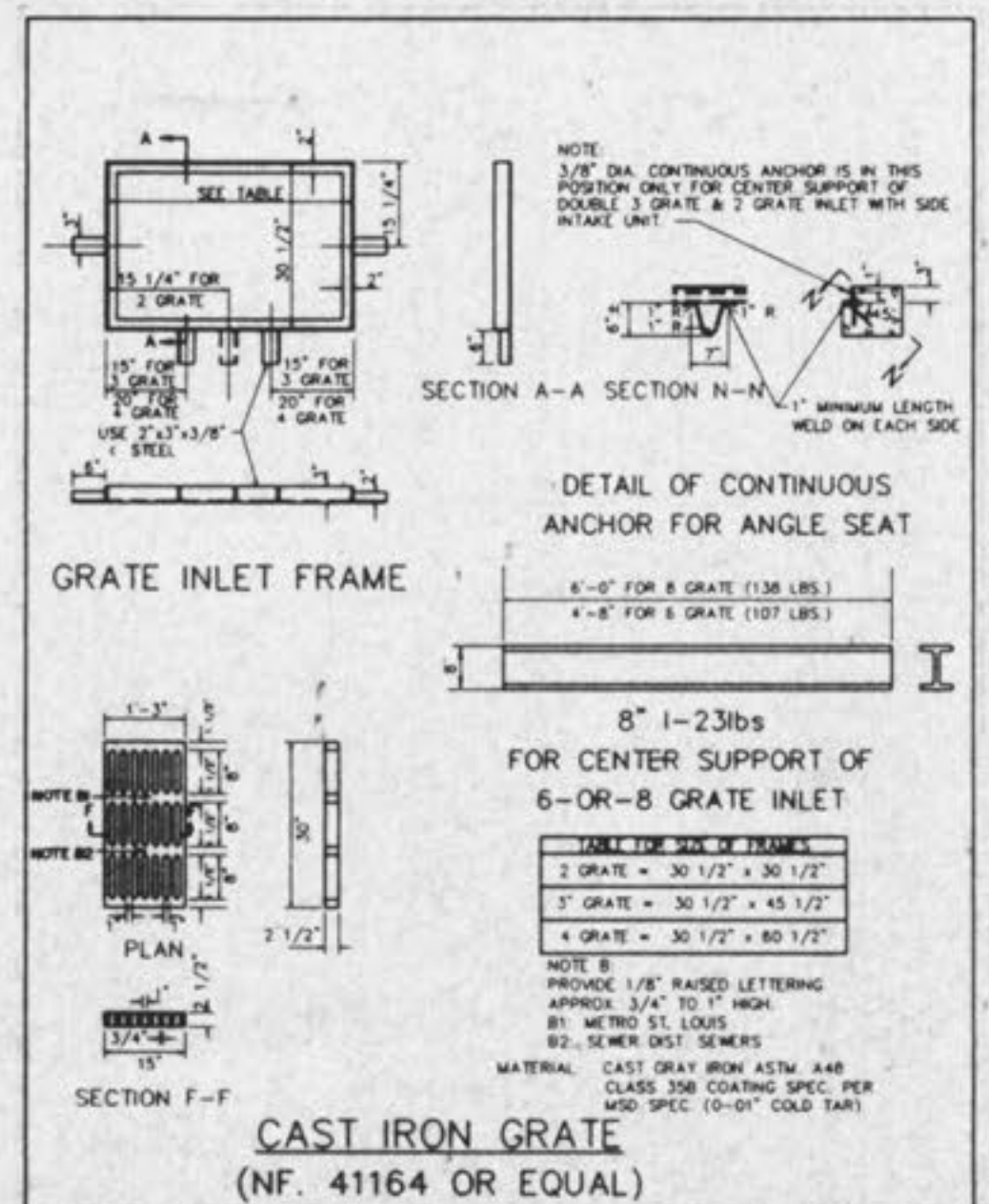

DETAILS OF INLET FRAME AND GRATES
METROPOLITAN ST. LOUIS SEWER DISTRICT
Standard Details of Sewer Construction
Dr. R.G.W. CH. J.C.K. 1992 SHEET 44

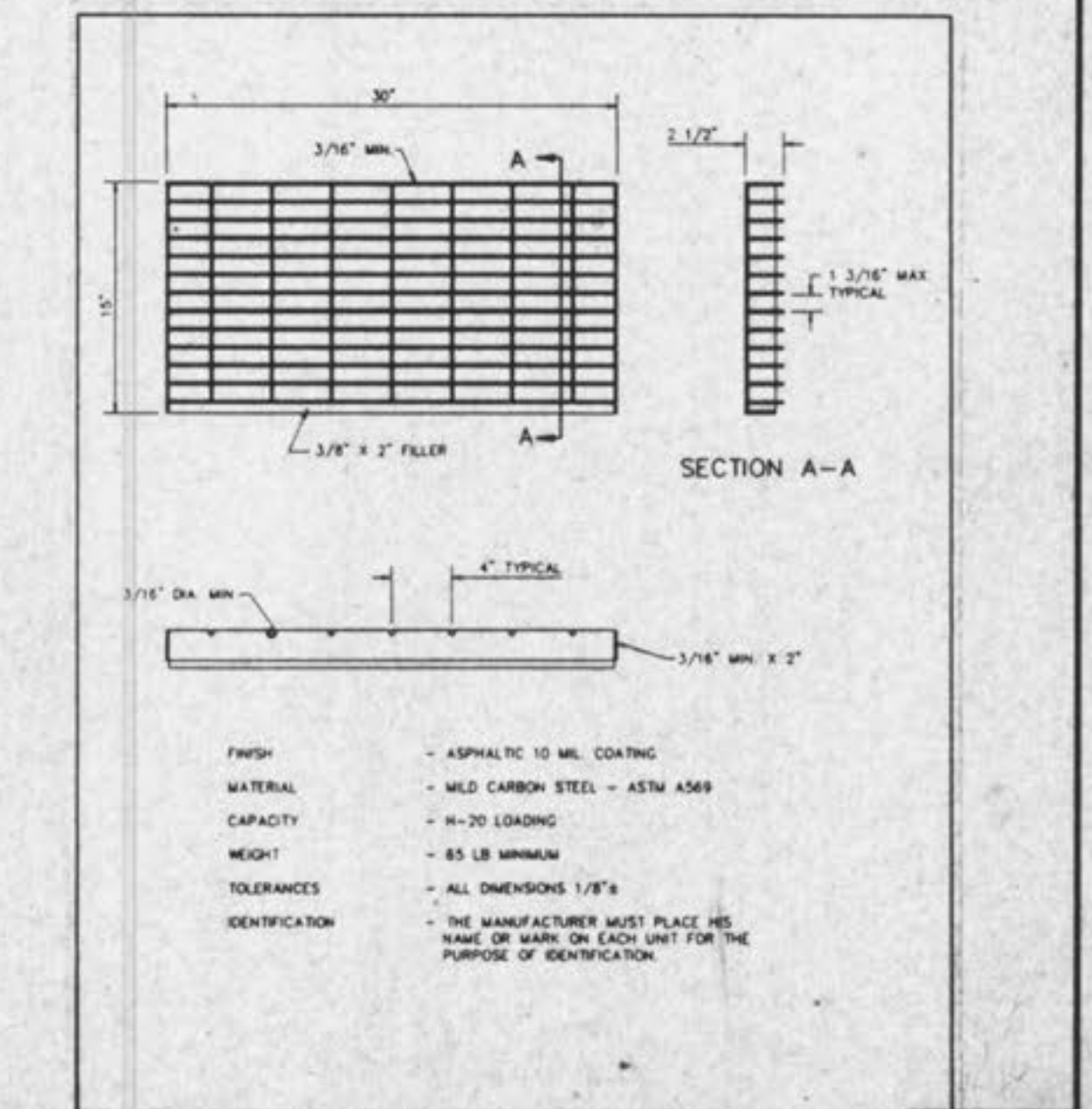

DETAIL OF STEEL GRATE
METROPOLITAN ST. LOUIS SEWER DISTRICT
Standard Details of Sewer Construction
Dr. R.G.W. CH. J.C.K. 1992 SHEET 45