

CALL	USE	Ø	STRAIGHT BARS
G-1	2, 3, OR 4 GRATE	3'-4"	
G-2	6 & 8' GRATE	5'-10"	
H-2	2 GRATE	3'-6"	
H-3	3 & 6 GRATE	4'-9"	
H-4	4 & 8 GRATE	6'-0"	

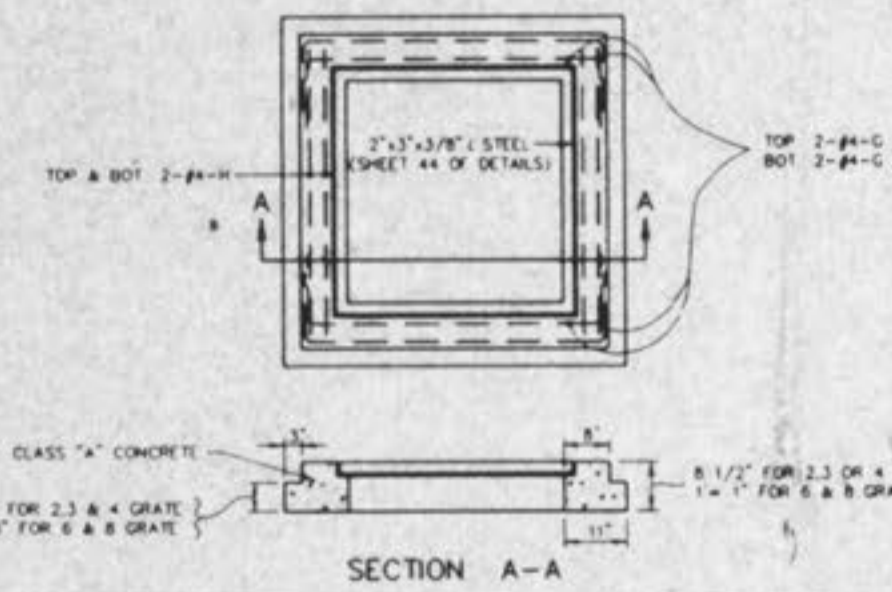

STEEL REQUIREMENTS FOR GRATE INLET SEAT
 METROPOLITAN ST. LOUIS SEWER DISTRICT
 Standard Details of Sewer Construction
 Dr. W.S.H. Ch. J.C.K. 1992 SHEET 46

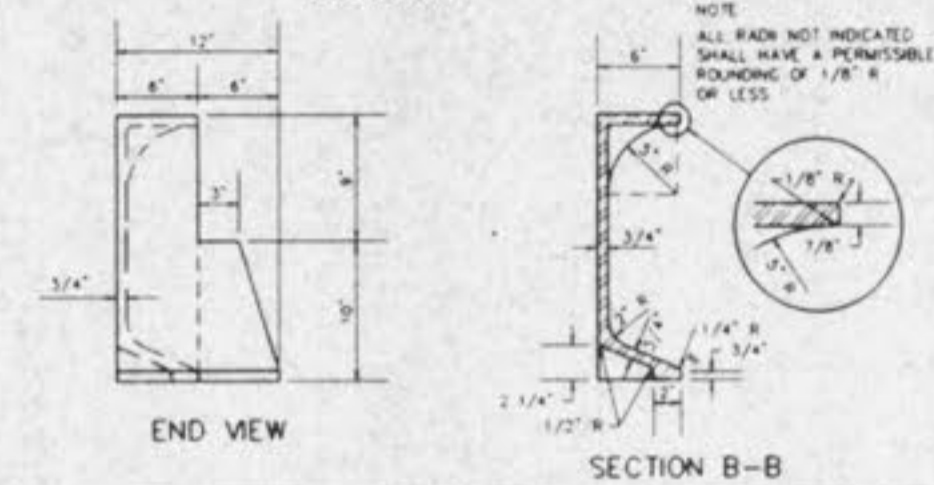
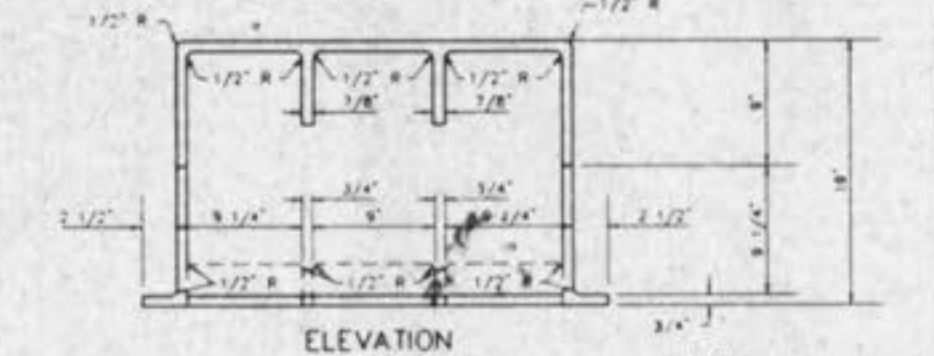
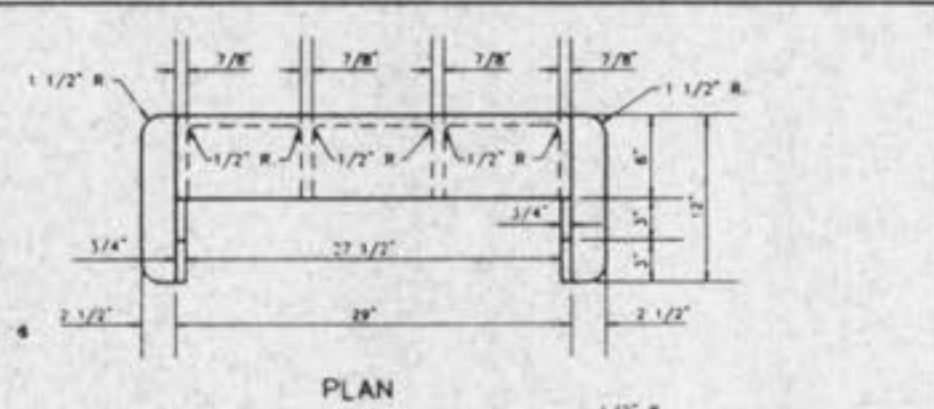

CAST IRON SIDE INTAKE UNIT FOR GRATED INLETS
 249 LBS.
 METROPOLITAN ST. LOUIS SEWER DISTRICT
 Standard Details of Sewer Construction
 Dr. R.G.W. Ch. J.C.K. 1992 SHEET 47

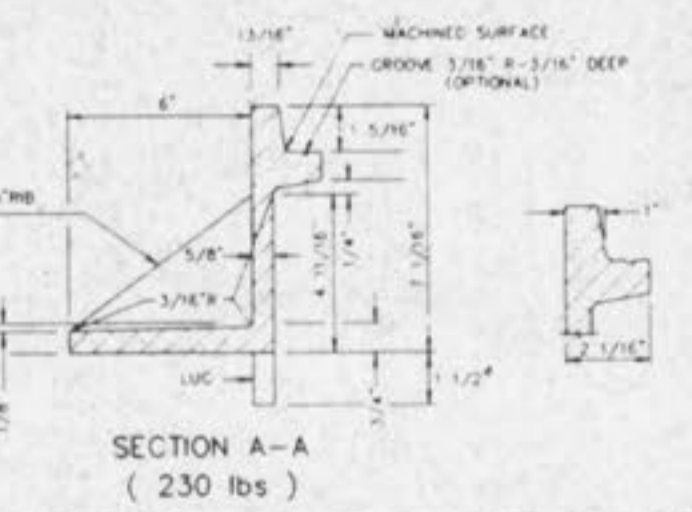
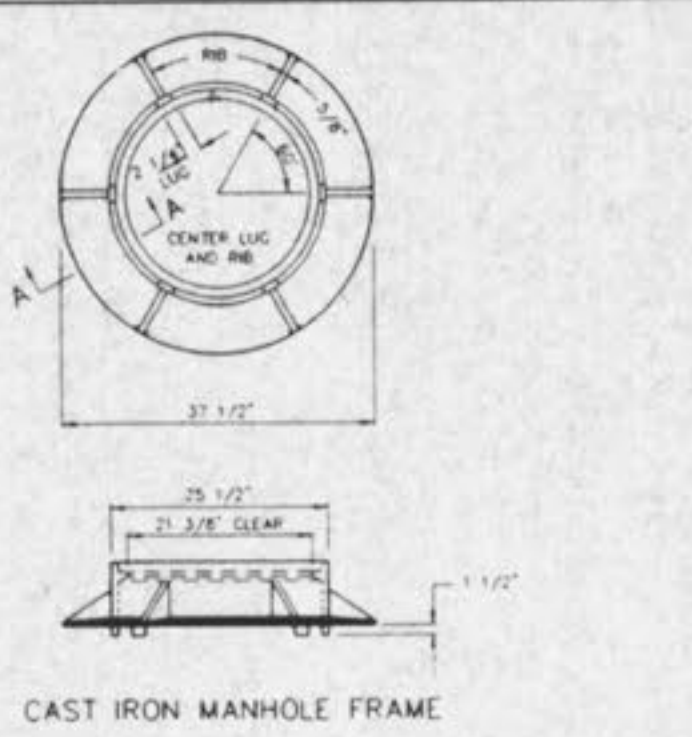

CAST IRON MANHOLE FRAME
 METROPOLITAN ST. LOUIS SEWER DISTRICT
 Standard Details of Sewer Construction
 Dr. D.A.B. Ch. J.C.K. 1992 SHEET 48

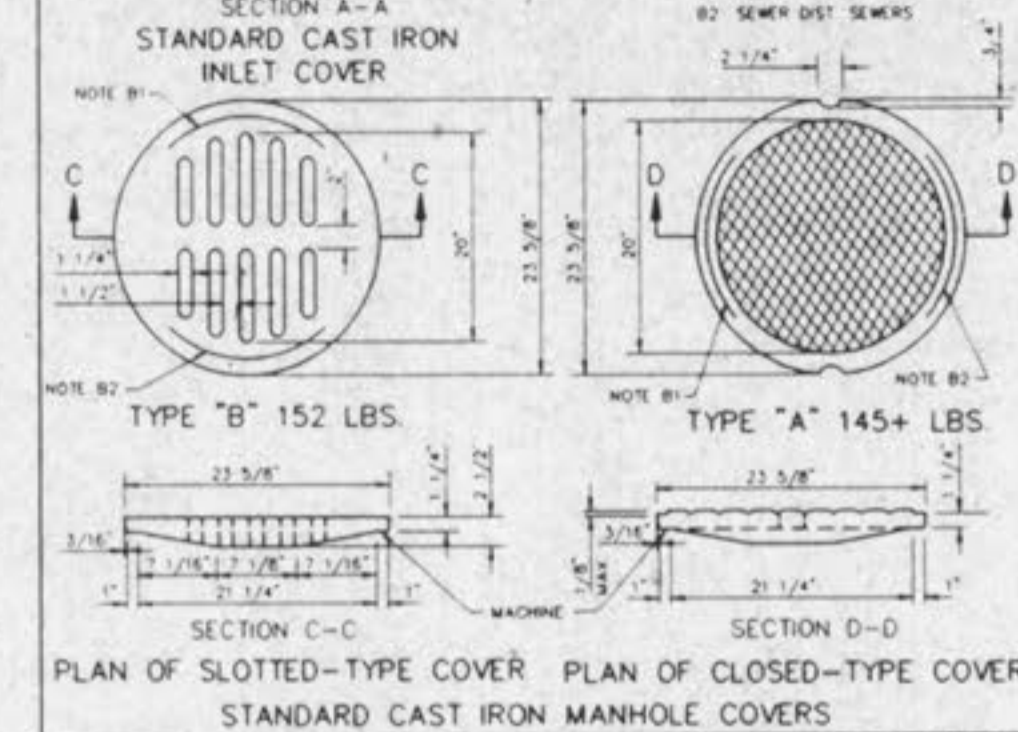
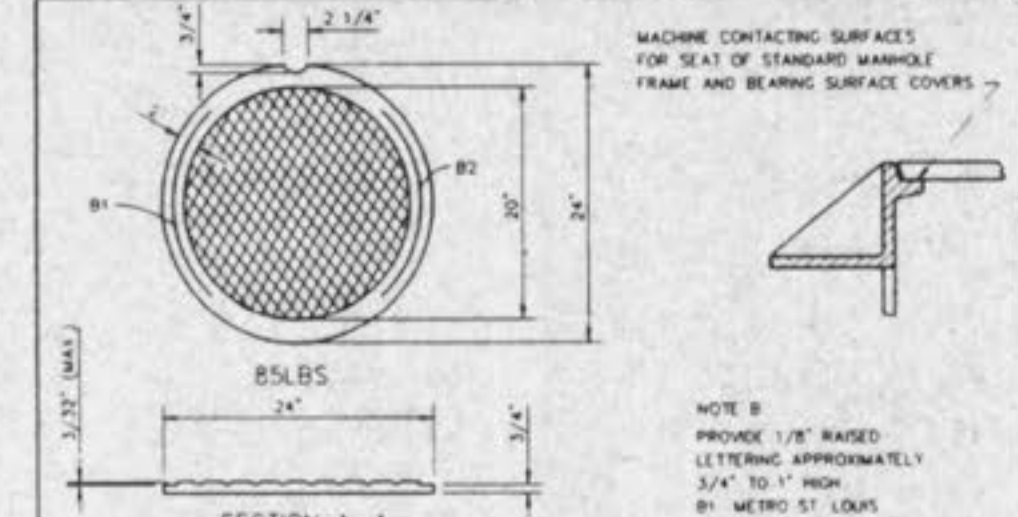

CAST IRON COVERS MANHOLES AND INLETS
 METROPOLITAN ST. LOUIS SEWER DISTRICT
 Standard Details of Sewer Construction
 Dr. R.G.W. Ch. J.C.K. 1992 SHEET 49

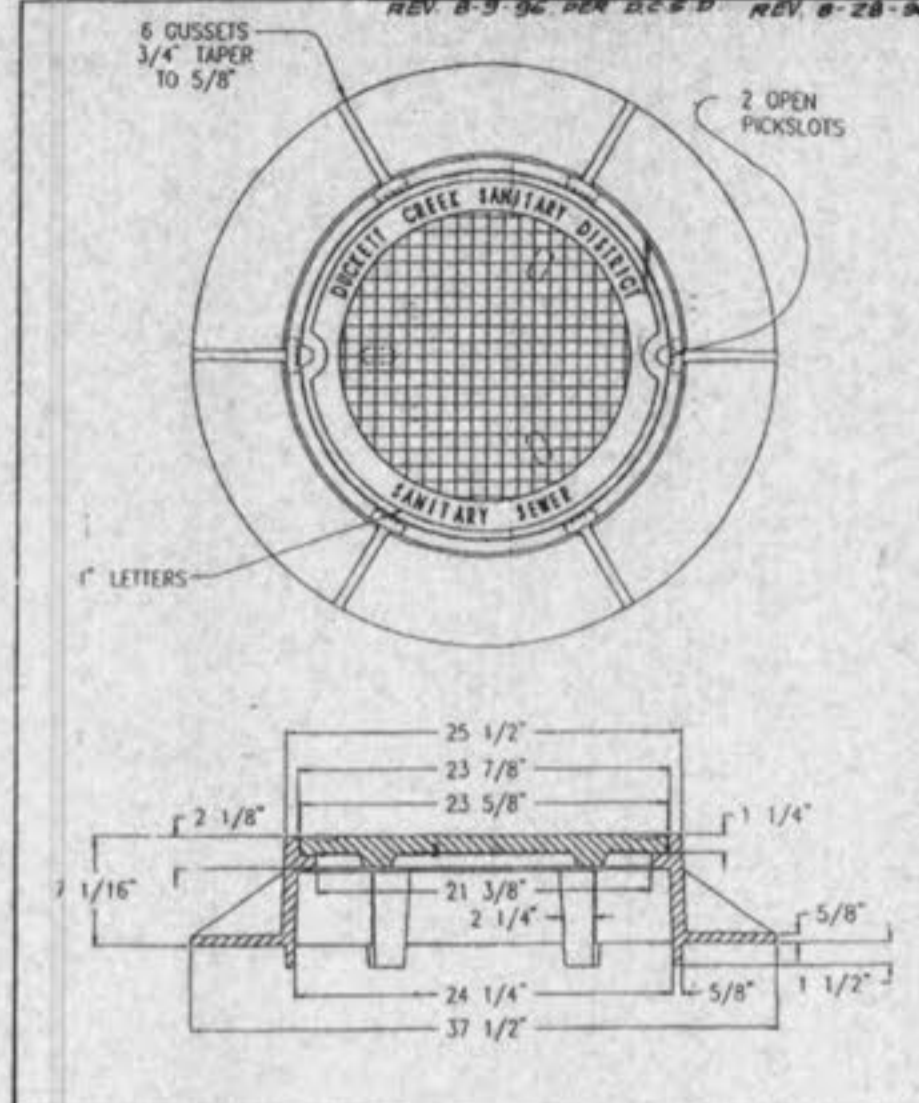

MANHOLE RING & COVER
 DUCKETT CREEK SANITARY DISTRICT
 STANDARD CONSTRUCTION DETAIL
 DETAIL NO. MAY 1996

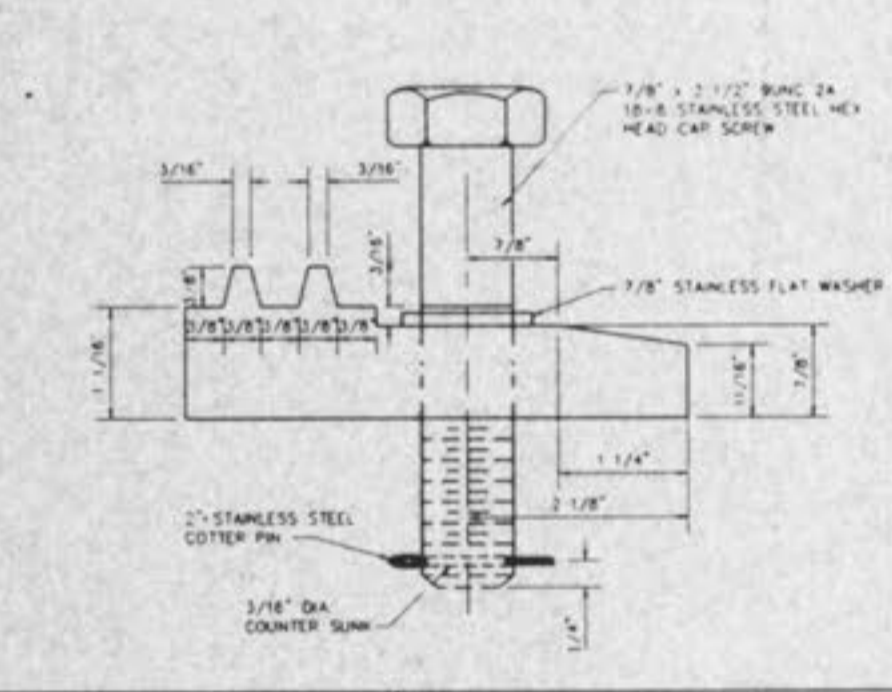
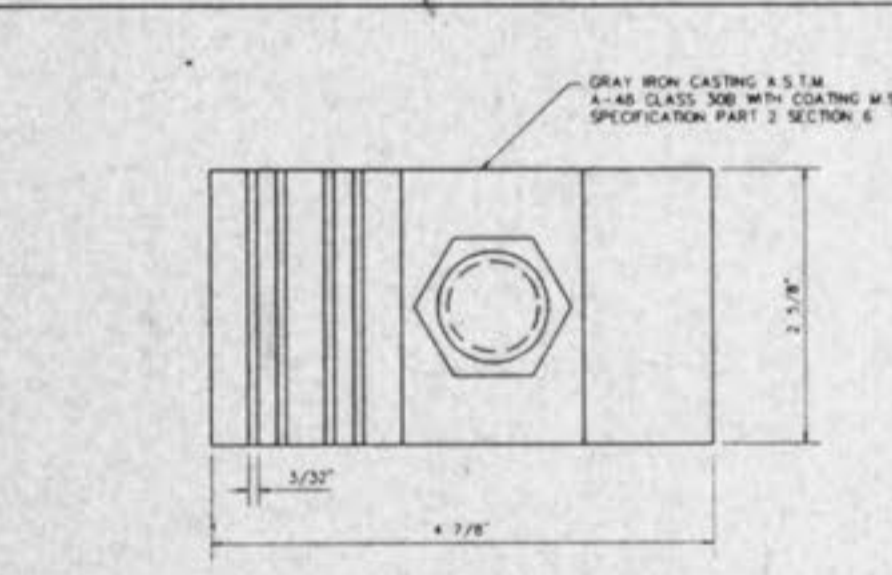

LOCKING DEVICE FOR TYPE "I" LOCK TYPE MANHOLE COVER
 METROPOLITAN ST. LOUIS SEWER DISTRICT
 Standard Details of Sewer Construction
 Dr. R.G.W. Ch. J.C.K. 1992 SHEET 51

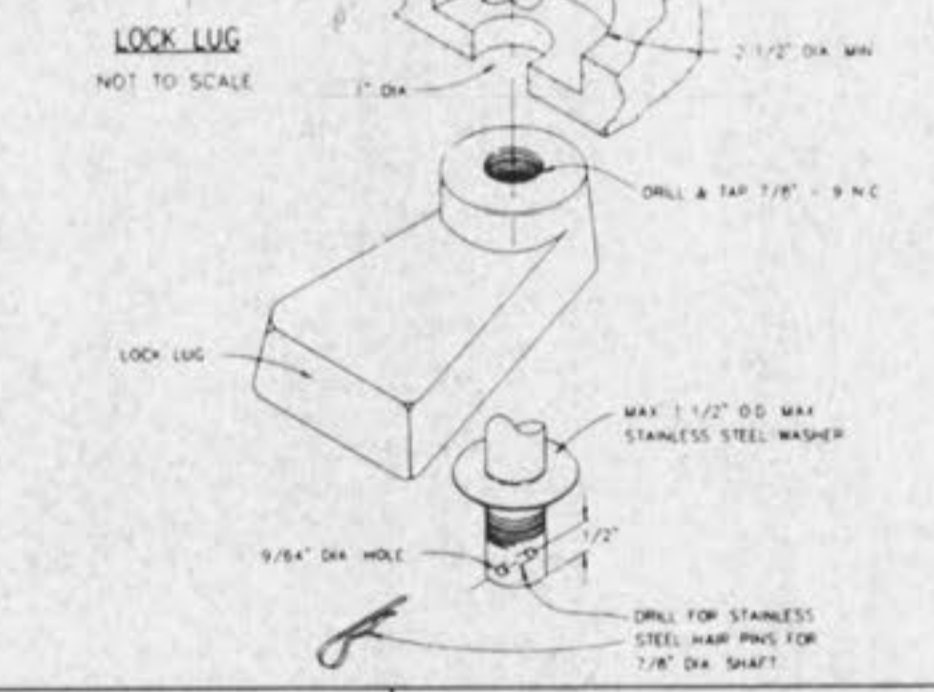
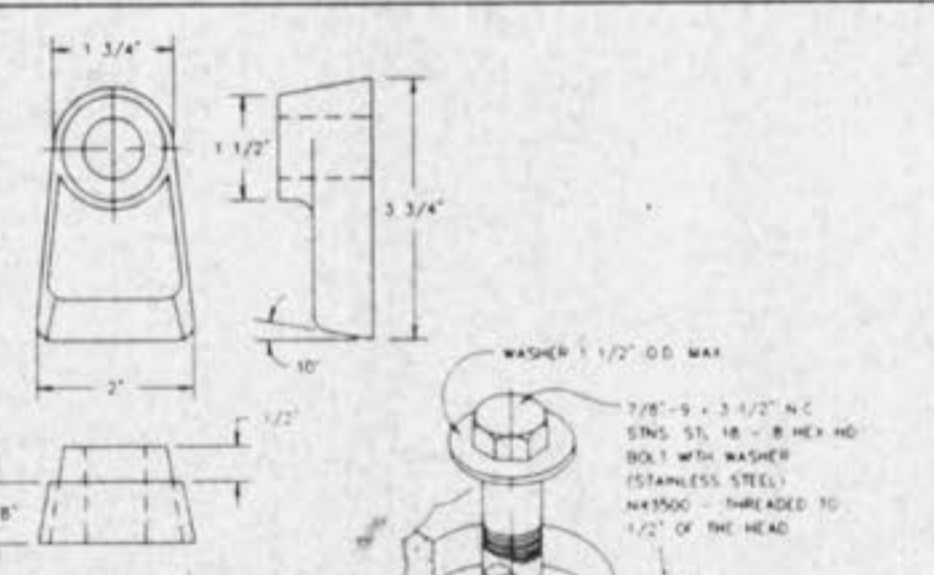

LOCKING DEVICE FOR TYPE "N" LOCK TYPE MANHOLE COVER
 METROPOLITAN ST. LOUIS SEWER DISTRICT
 Standard Details of Sewer Construction
 Dr. J.L.G. Ch. J.C.K. 1992 SHEET 52

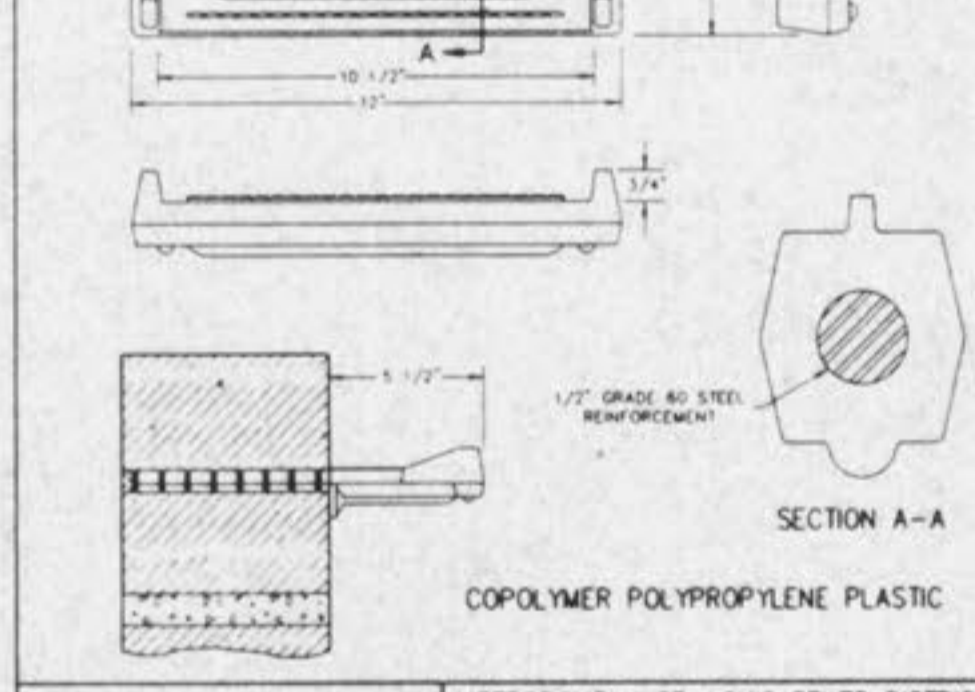
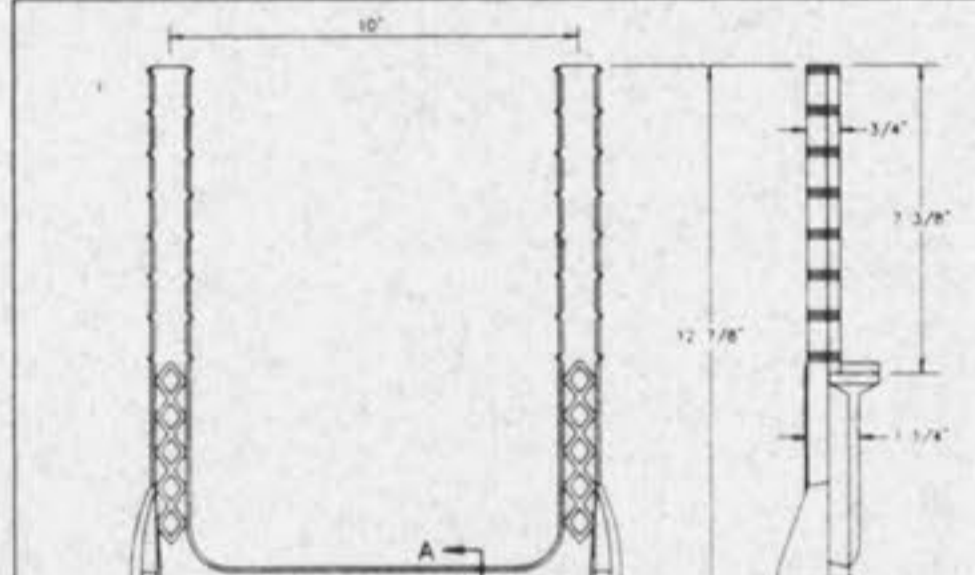

PSI-B MANHOLE STEP INTO JOINT
 METROPOLITAN ST. LOUIS SEWER DISTRICT
 Standard Details of Sewer Construction
 Dr. W.S.H. Ch. J.C.K. 1992 SHEET 53

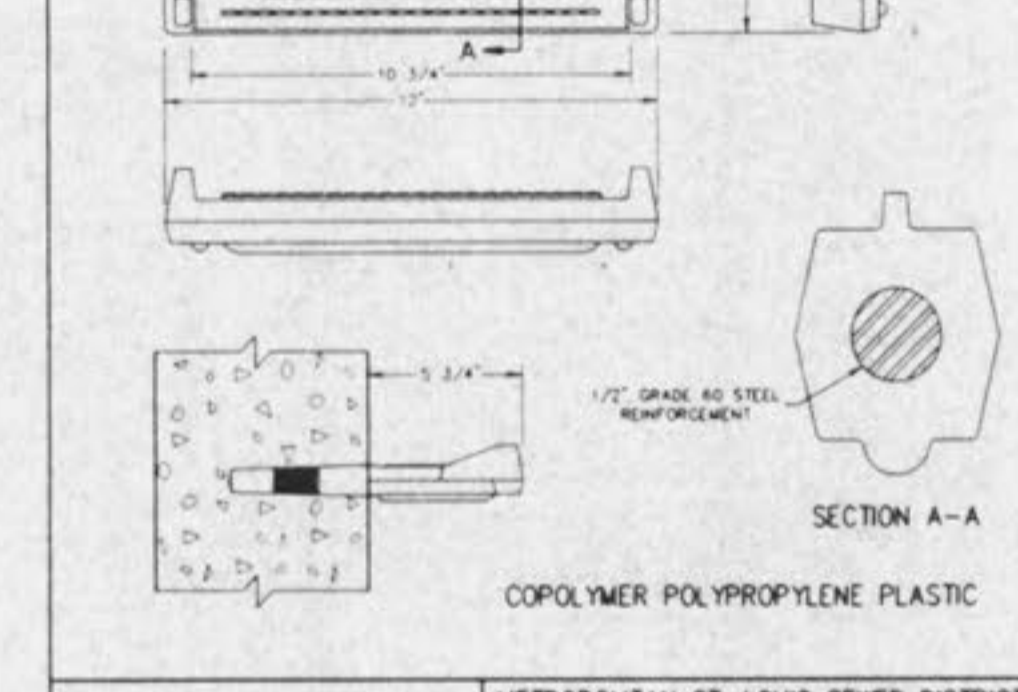
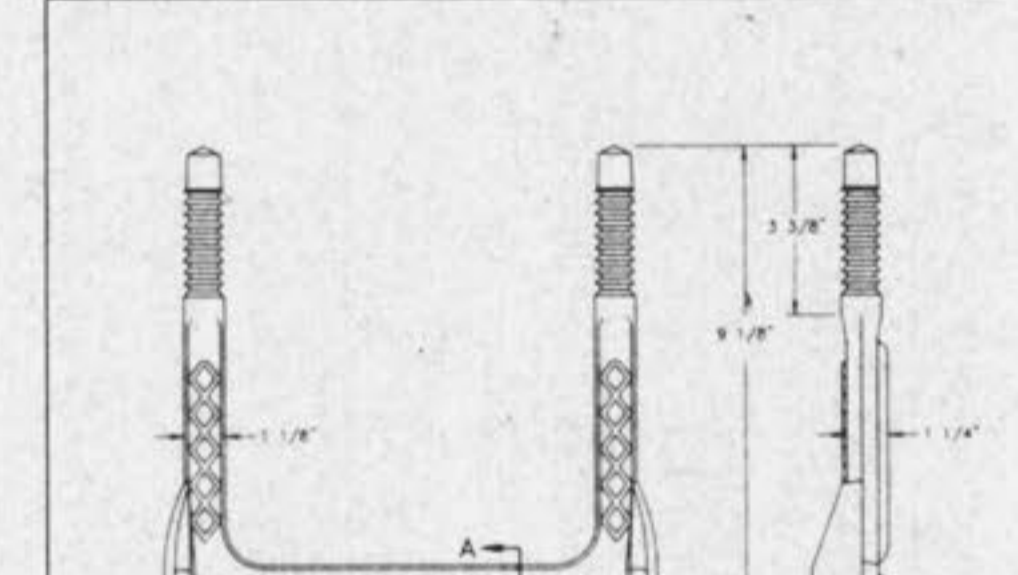

MANHOLE STEP FOR PRECAST MANHOLE
 METROPOLITAN ST. LOUIS SEWER DISTRICT
 Standard Details of Sewer Construction
 Dr. D.A.B. Ch. J.C.K. 1992 SHEET 54

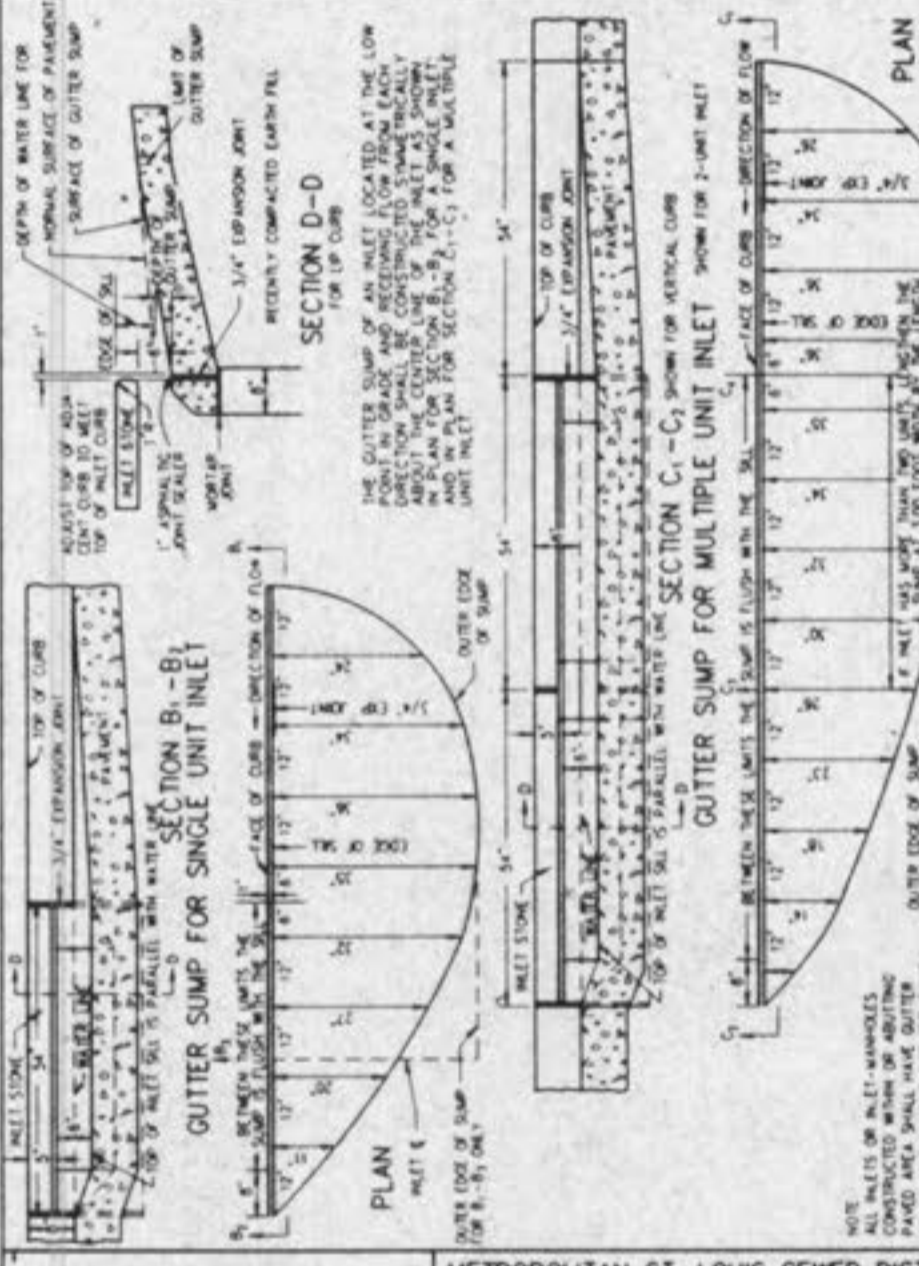

GUTTER SUMPS FOR VERTICAL CURB
 METROPOLITAN ST. LOUIS SEWER DISTRICT
 Standard Details of Sewer Construction
 Dr. W.S.H. Ch. J.C.K. 1992 SHEET 55

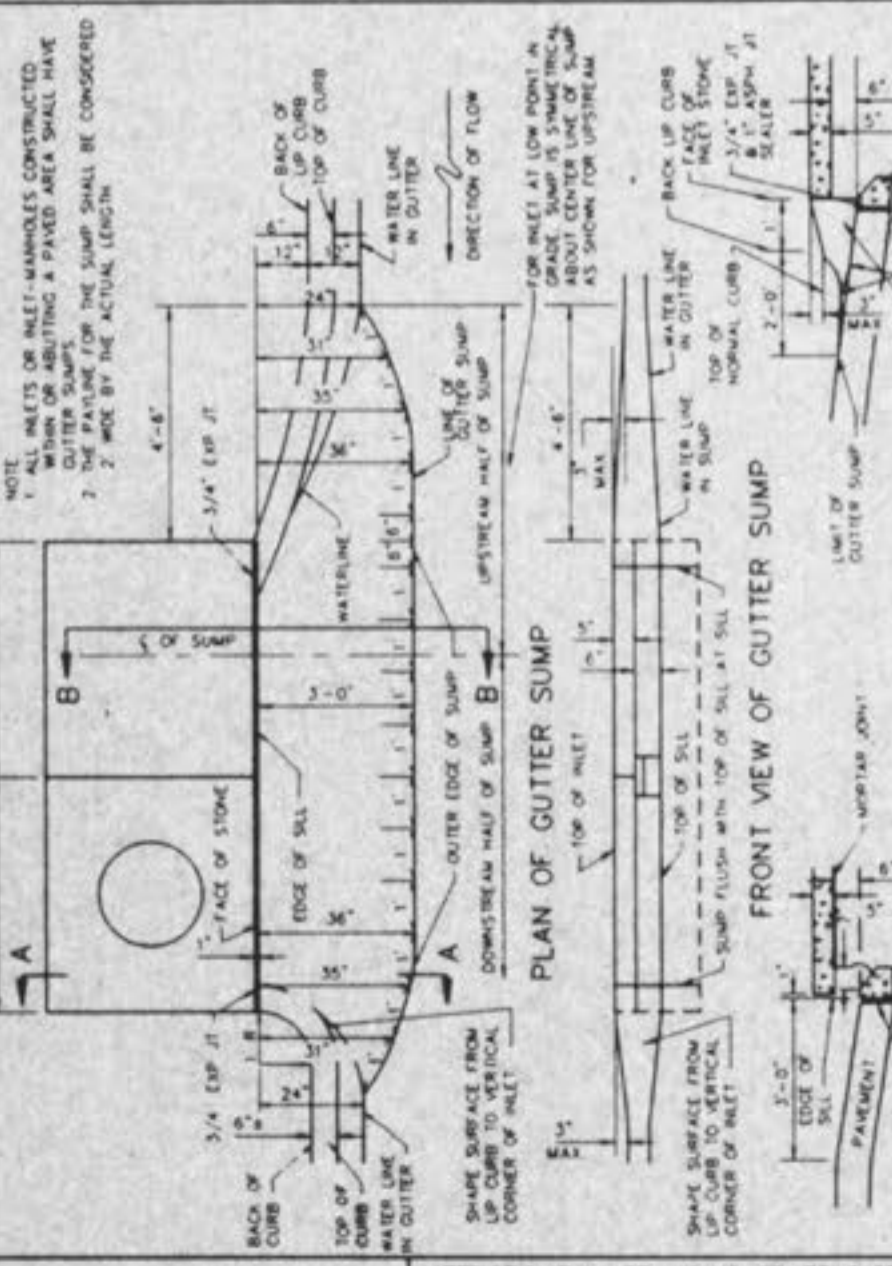

GUTTER SUMP FOR LIP CURB
 METROPOLITAN ST. LOUIS SEWER DISTRICT
 Standard Details of Sewer Construction
 Dr. R.G.W. Ch. J.C.K. 1992 SHEET 56

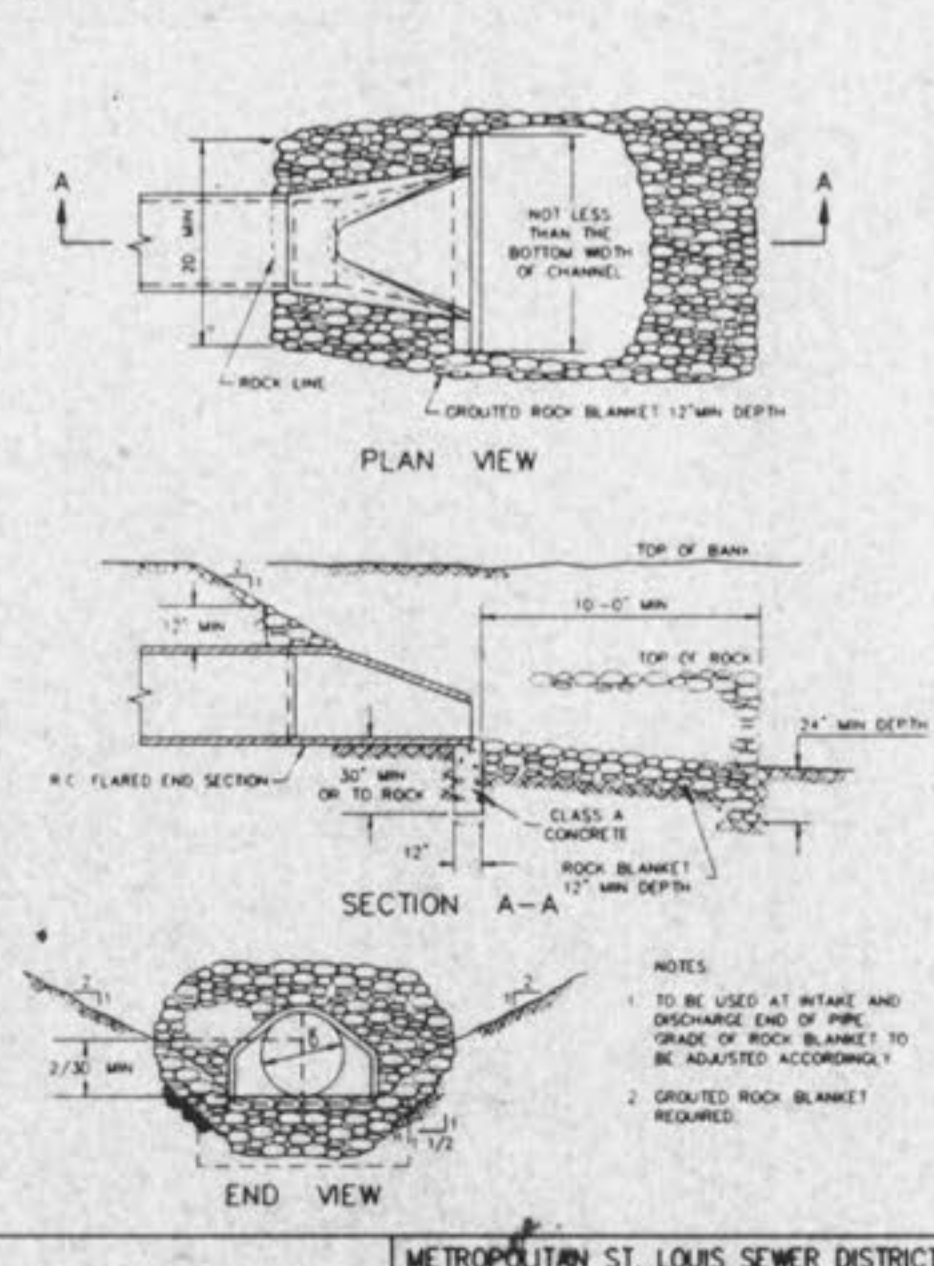

FLARED END SECTION
 METROPOLITAN ST. LOUIS SEWER DISTRICT
 Standard Details of Sewer Construction
 Dr. W.S.H. Ch. J.C.K. 1992 SHEET 57

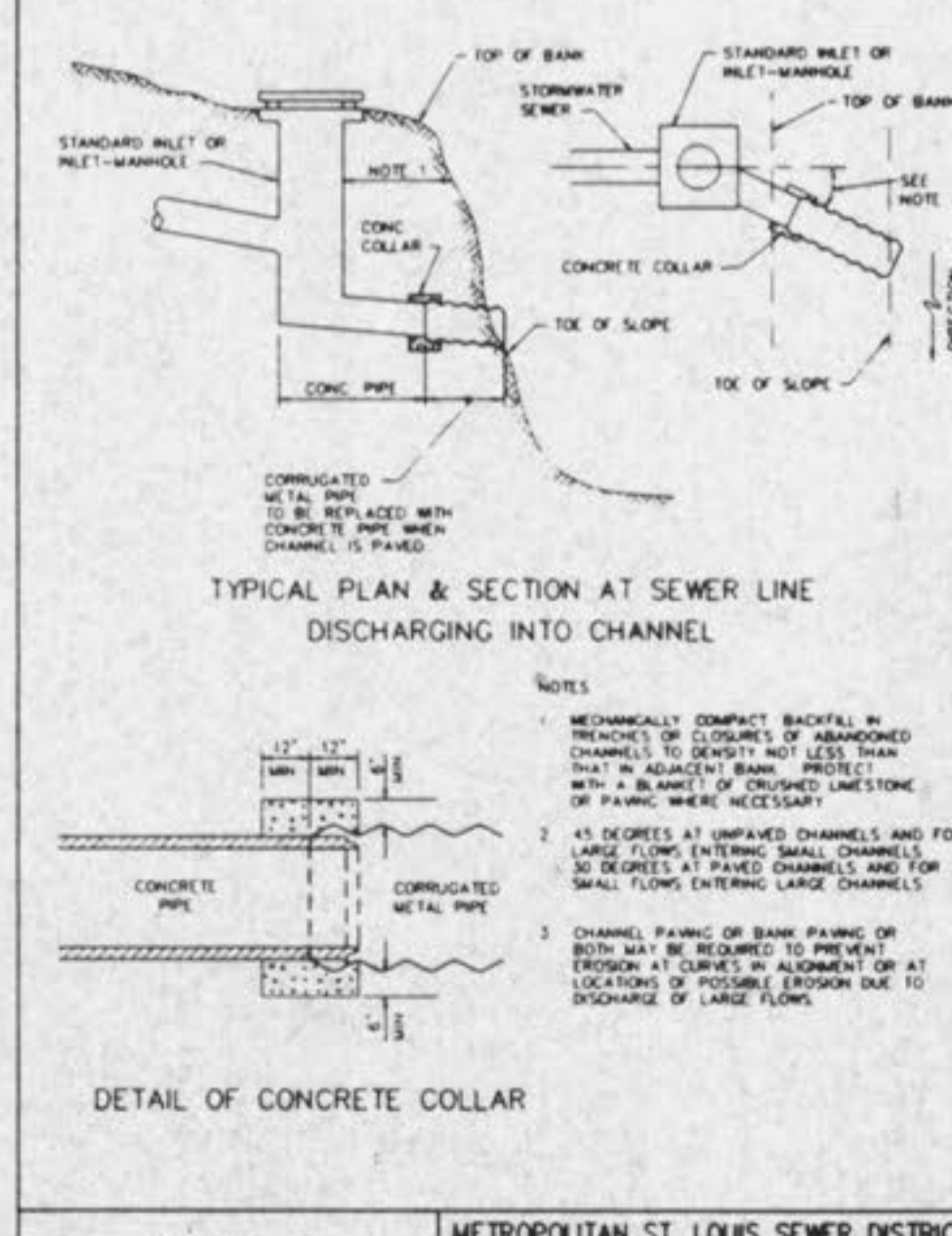

DETAIL OF CONCRETE COLLAR
 METROPOLITAN ST. LOUIS SEWER DISTRICT
 Standard Details of Sewer Construction
 Dr. R.G.W. Ch. J.C.K. 1992 SHEET 58

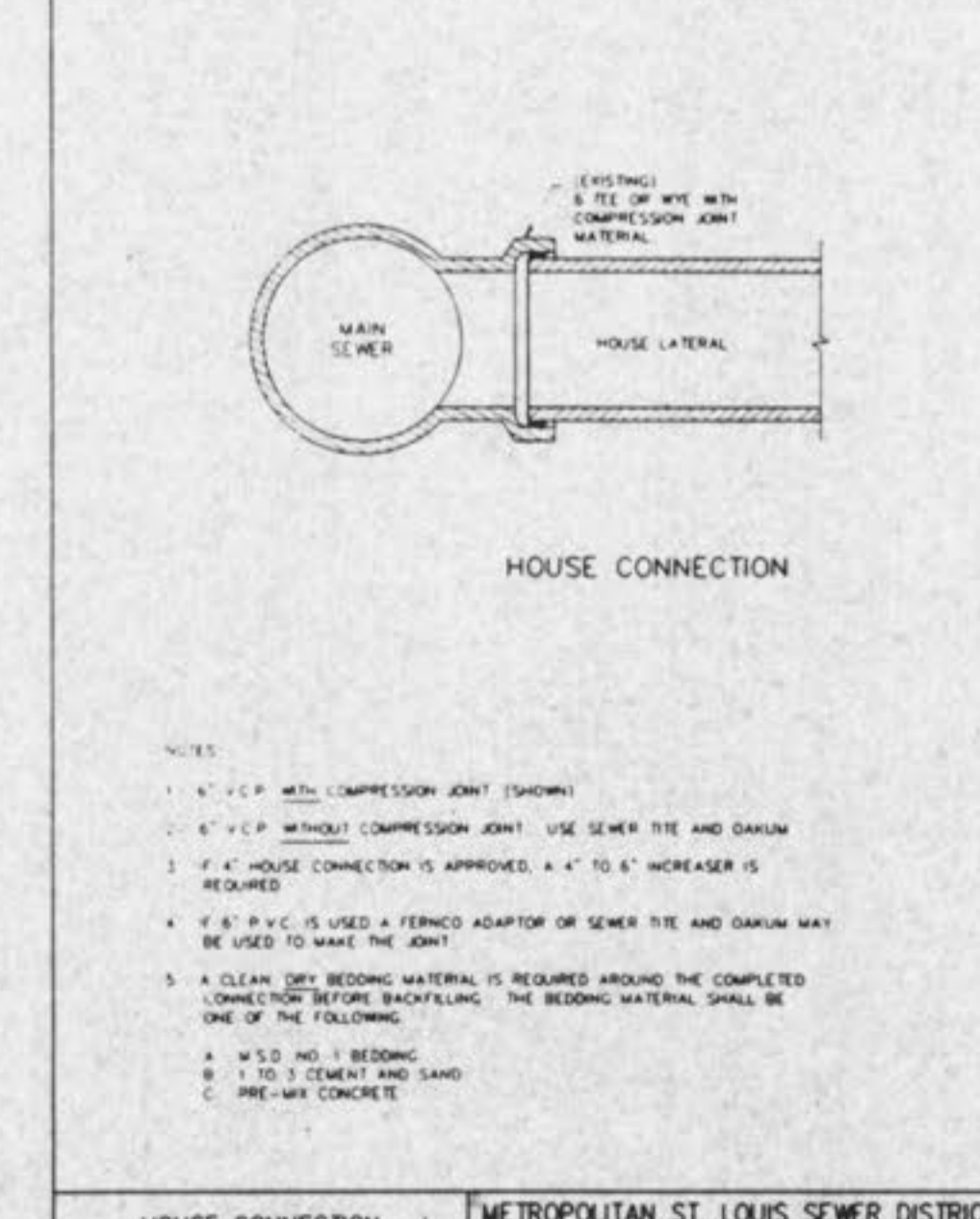

HOUSE CONNECTION TO EXISTING TEE OR WYE
 METROPOLITAN ST. LOUIS SEWER DISTRICT
 Standard Details of Sewer Construction
 Dr. D.A.B. Ch. J.C.K. 1992 SHEET 59

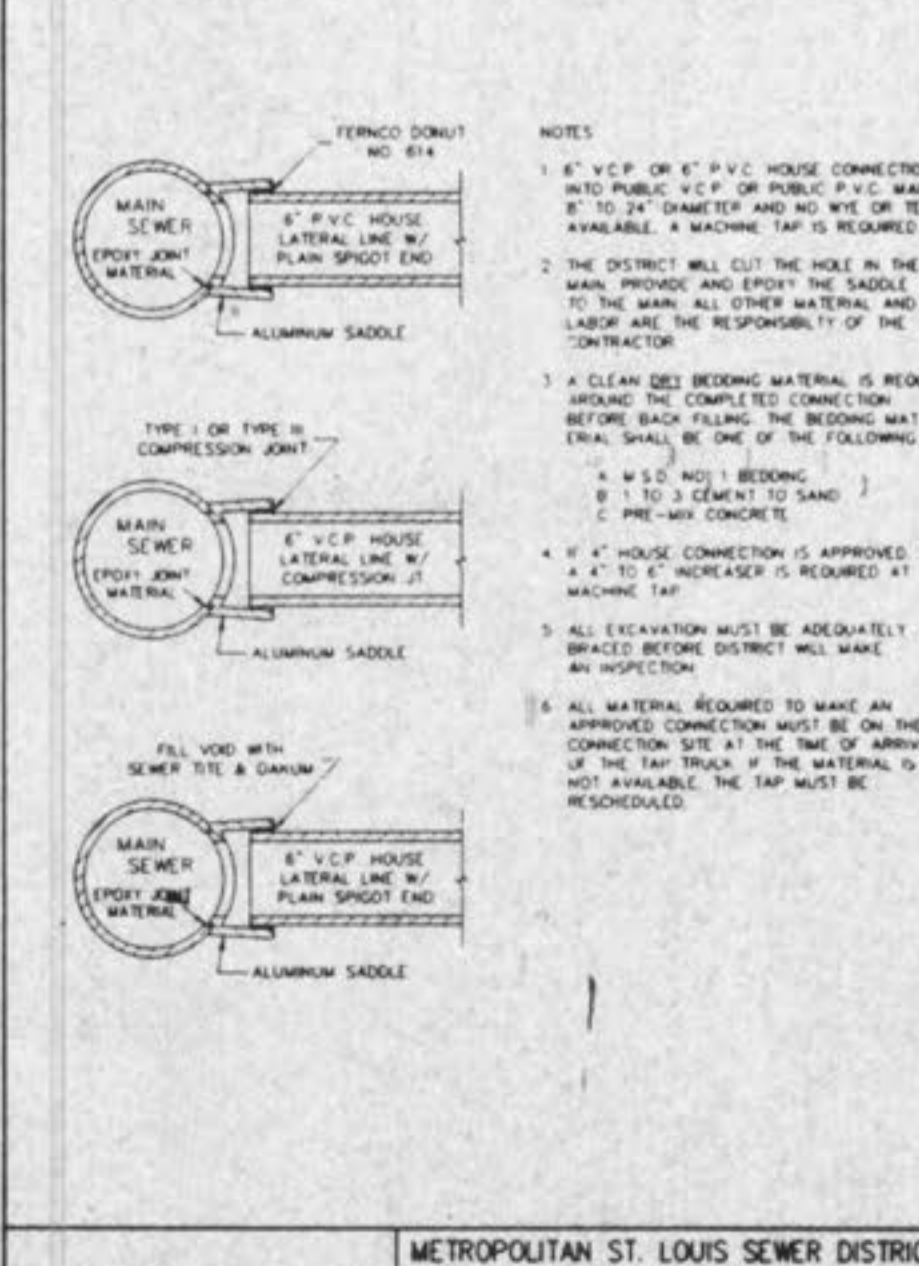

MACHINE TAP
 METROPOLITAN ST. LOUIS SEWER DISTRICT
 Standard Details of Sewer Construction
 Dr. W.S.H. Ch. J.C.K. 1992 SHEET 60