

NOTE: THE INTERNATIONAL SYMBOL OF ACCESSIBILITY SHALL BE THE STANDARD USED TO IDENTIFY FACILITIES THAT ARE ACCESSIBLE TO AND USABLE BY PHYSICALLY DISABLED PERSON AS SET FORTH IN THESE BUILDING STANDARDS. THE SYMBOL SPECIFIED ABOVE SHALL CONSIST OF A WHITE FIGURE ON A BLUE BACKGROUND. THE BLUE SHALL BE EQUAL TO COLOR NO. 15090 IN FEDERAL STANDARD 395c.

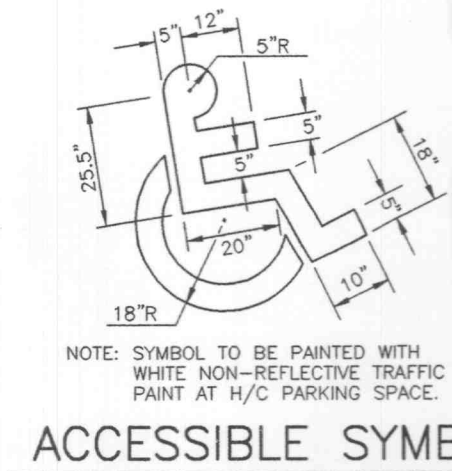

NOTE: SYMBOL TO BE PAINTED WITH WHITE NON-REFLECTIVE TRAFFIC PAINT AT H/C PARKING SPACE.

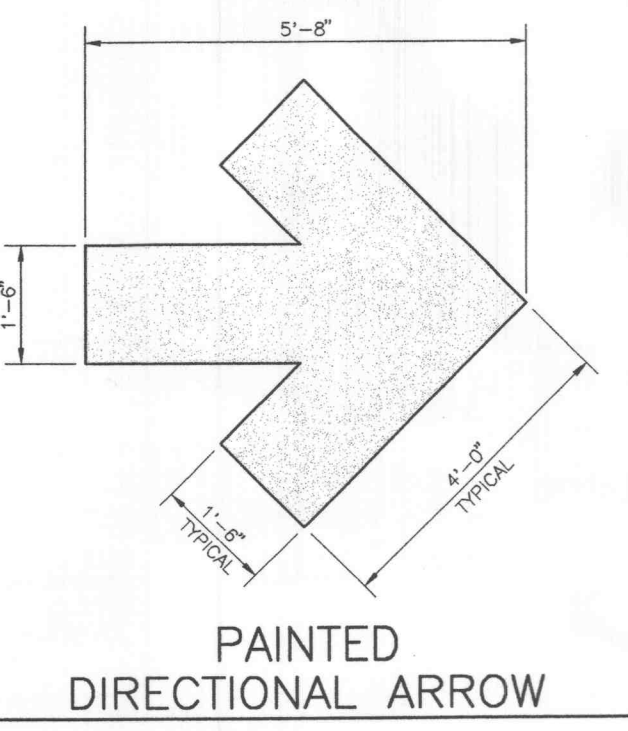
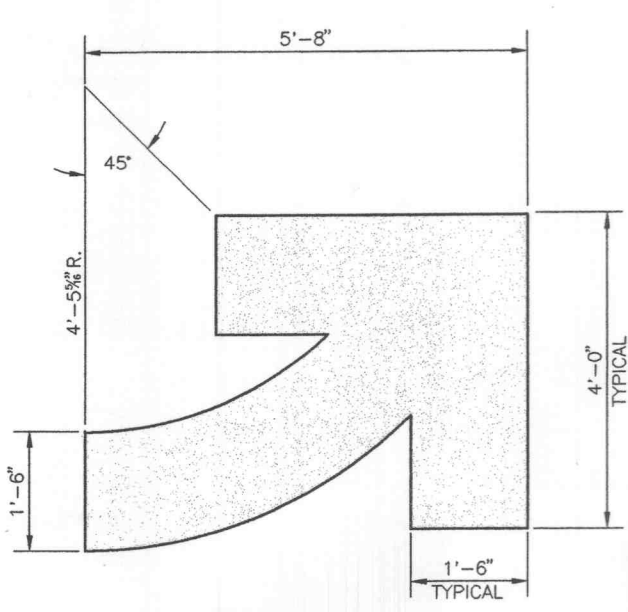
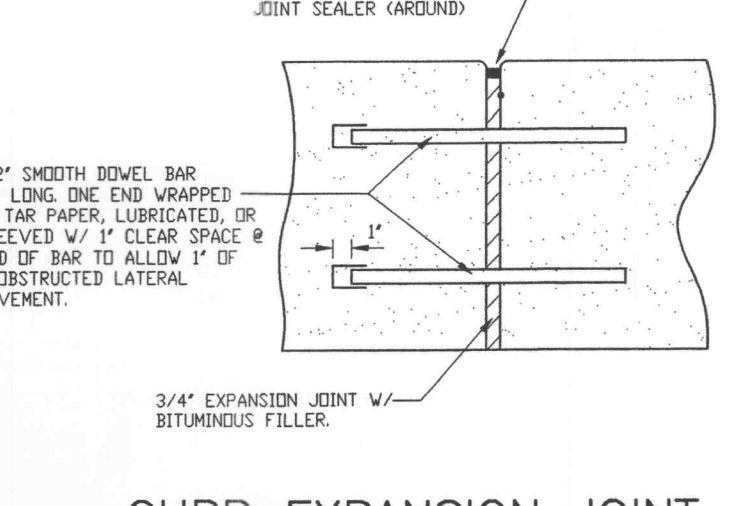
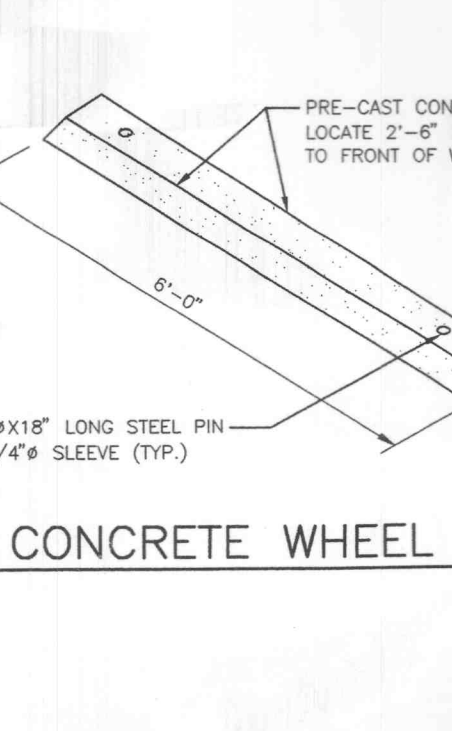

CURB EXPANSION JOINT

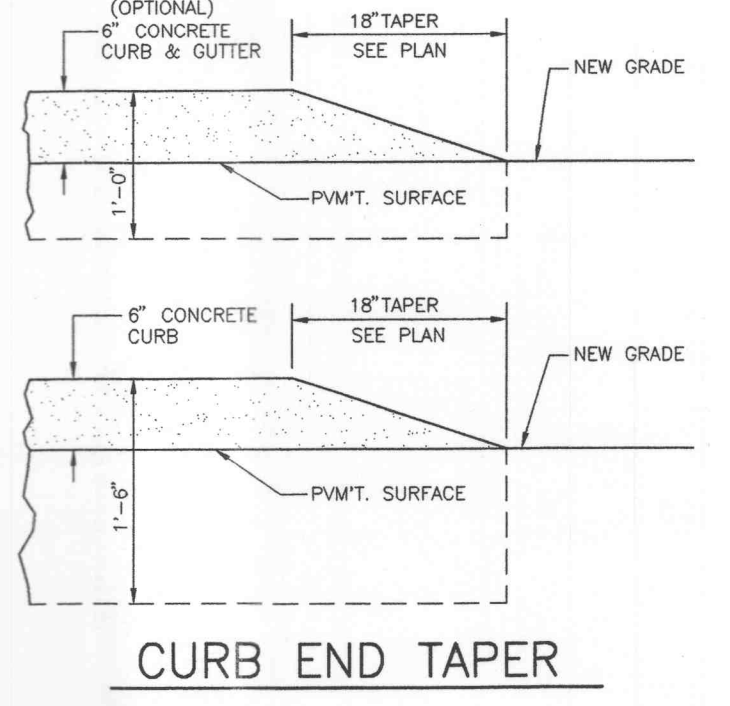

CURB END TAPER

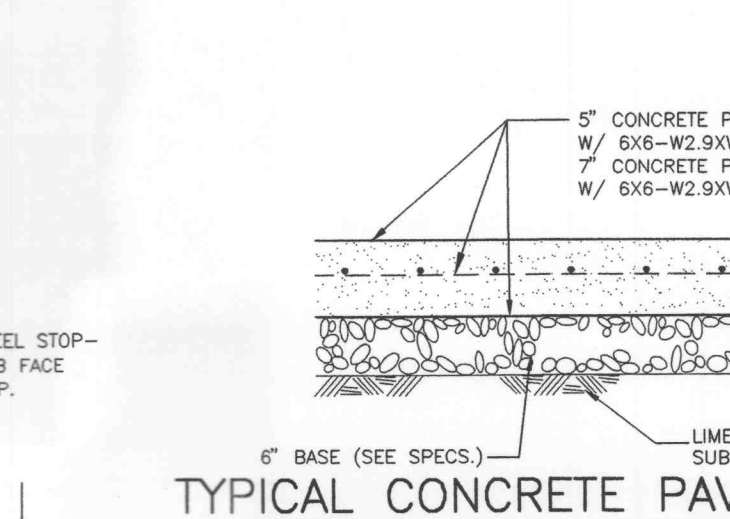

TYPICAL CONCRETE PAVING SECTION

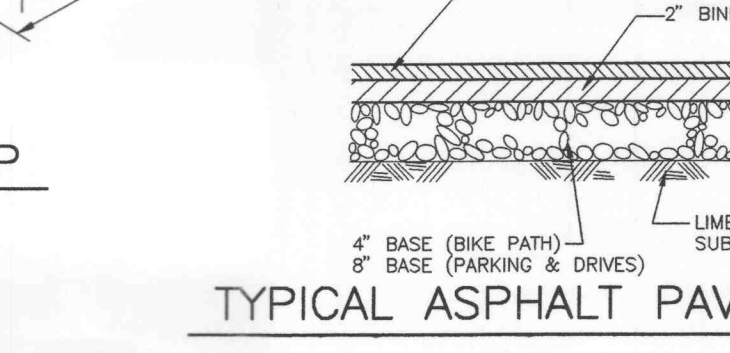

TYPICAL ASPHALT PAVING SECTION

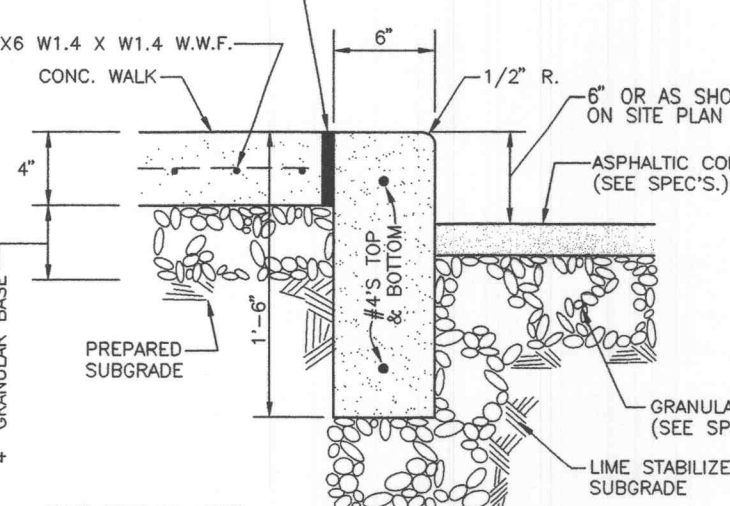

CONCRETE CURB AND WALK

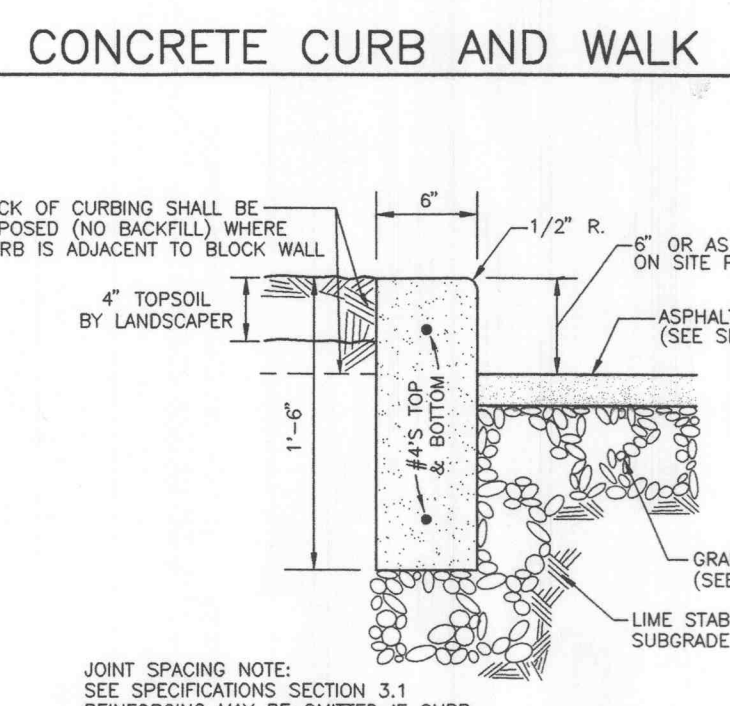

CONCRETE CURB AND GUTTER WITH WALK (OPTIONAL CONSTRUCTION)

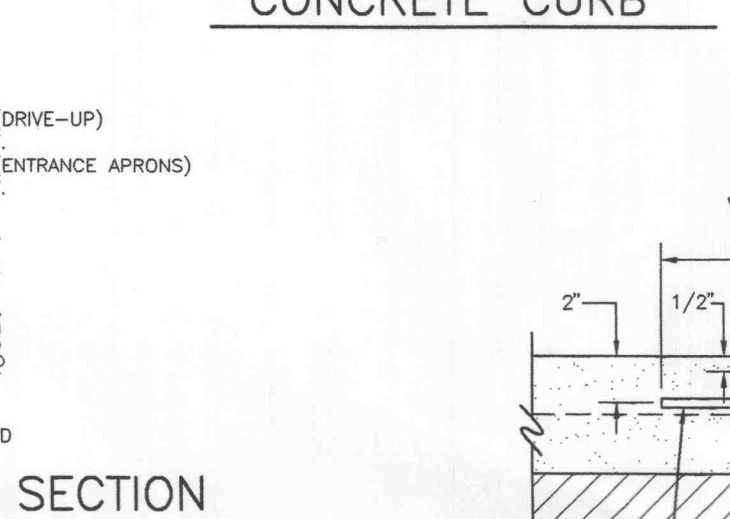

CONCRETE CURB

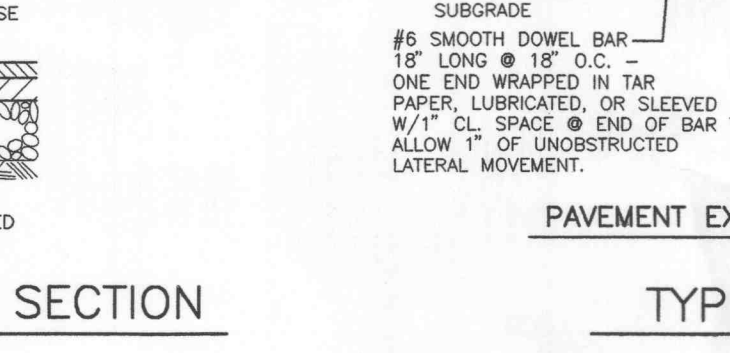

CONCRETE CURB AND GUTTER (OPTIONAL CONSTRUCTION)

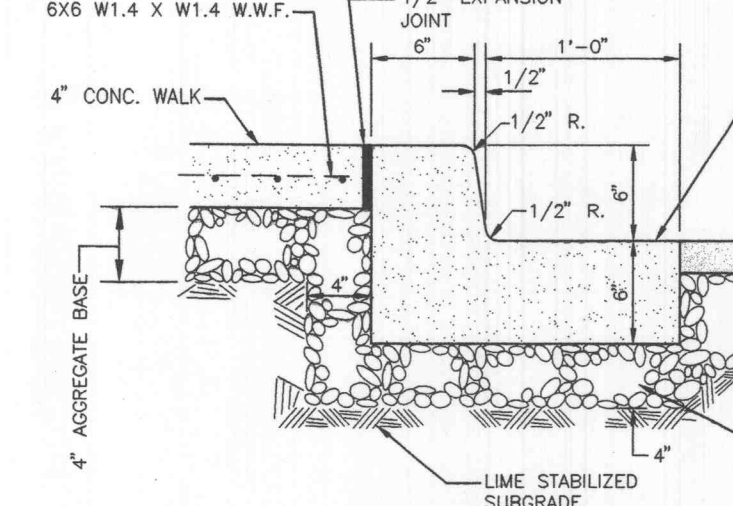

CONCRETE CURB AND GUTTER WITH WALK (OPTIONAL CONSTRUCTION)

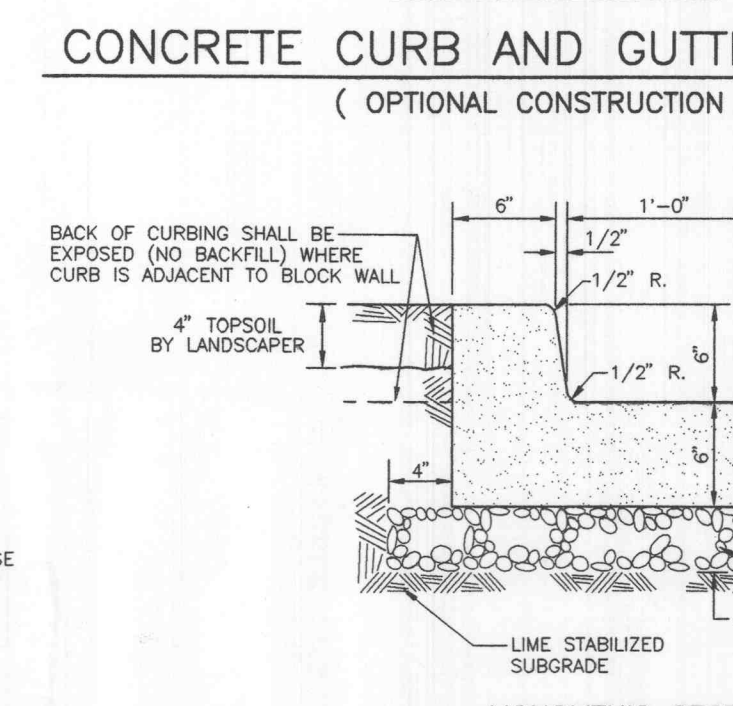

CONCRETE CURB AND GUTTER (OPTIONAL CONSTRUCTION)

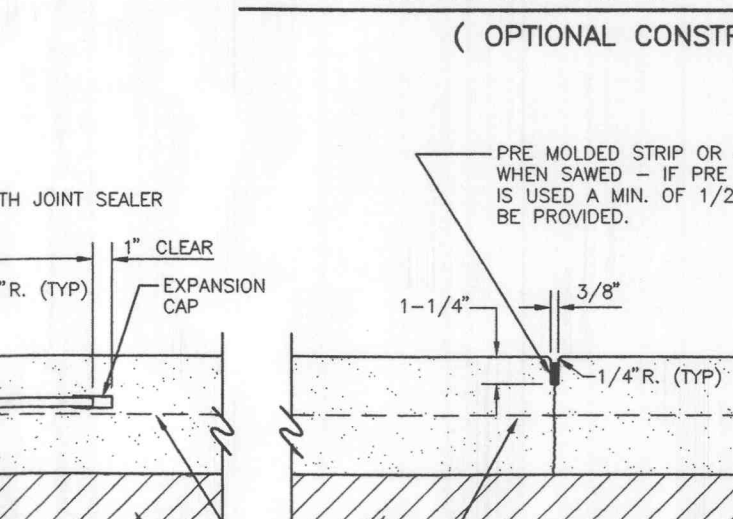

TYPICAL PAVEMENT AND JOINT DETAIL

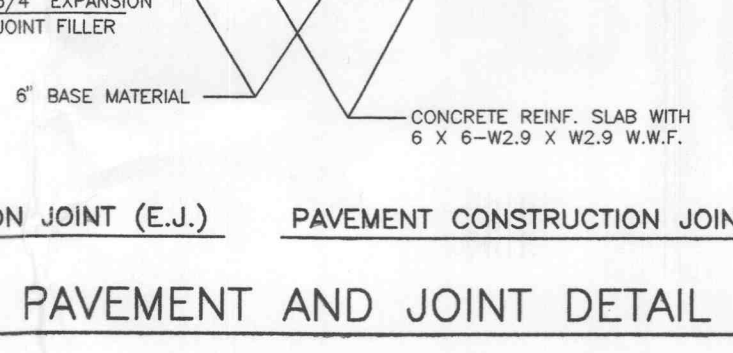

PAVEMENT CONSTRUCTION JOINT (C.J.)

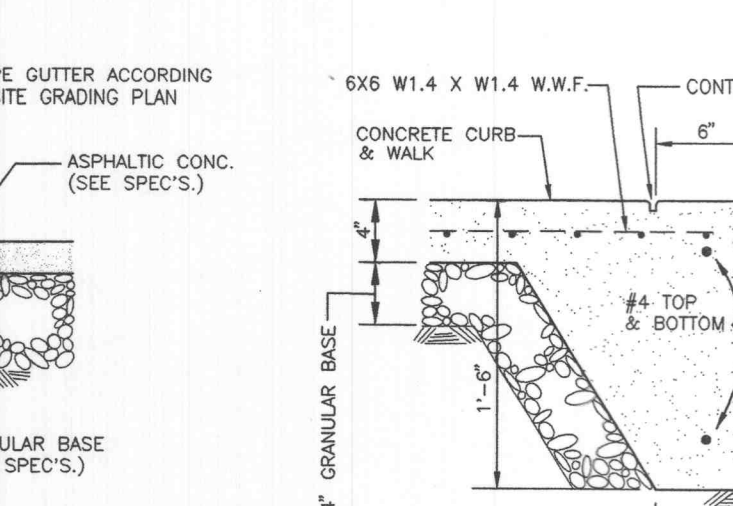

CONCRETE CURB AND GUTTER WITH WALK (OPTIONAL CONSTRUCTION)

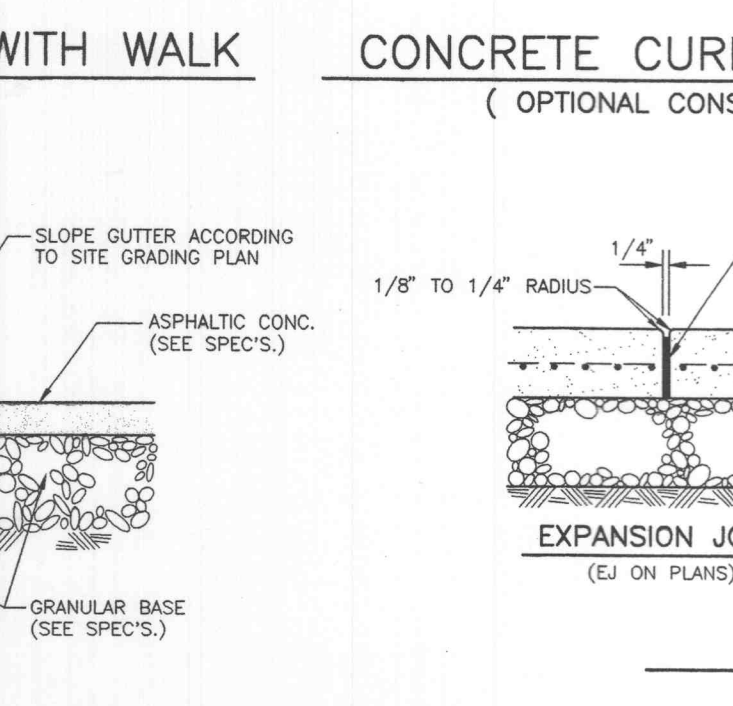

CONCRETE CURB AND GUTTER (OPTIONAL CONSTRUCTION)

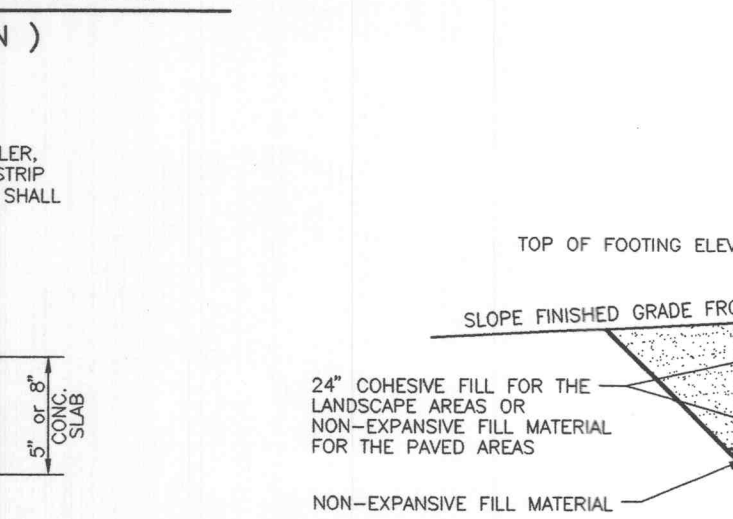

SIDEWALK SECTIONS

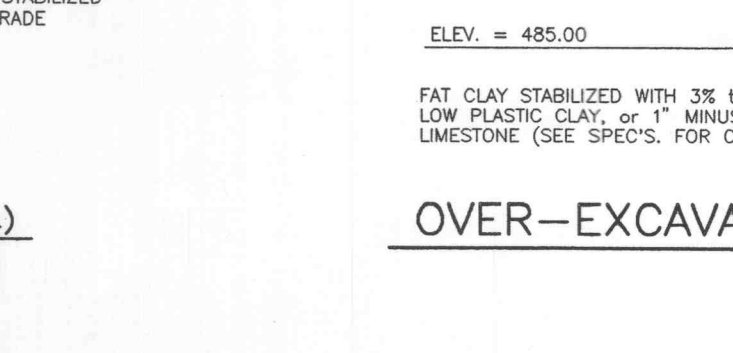

OVER-EXCAVATION AT BUILDING FOOTINGS

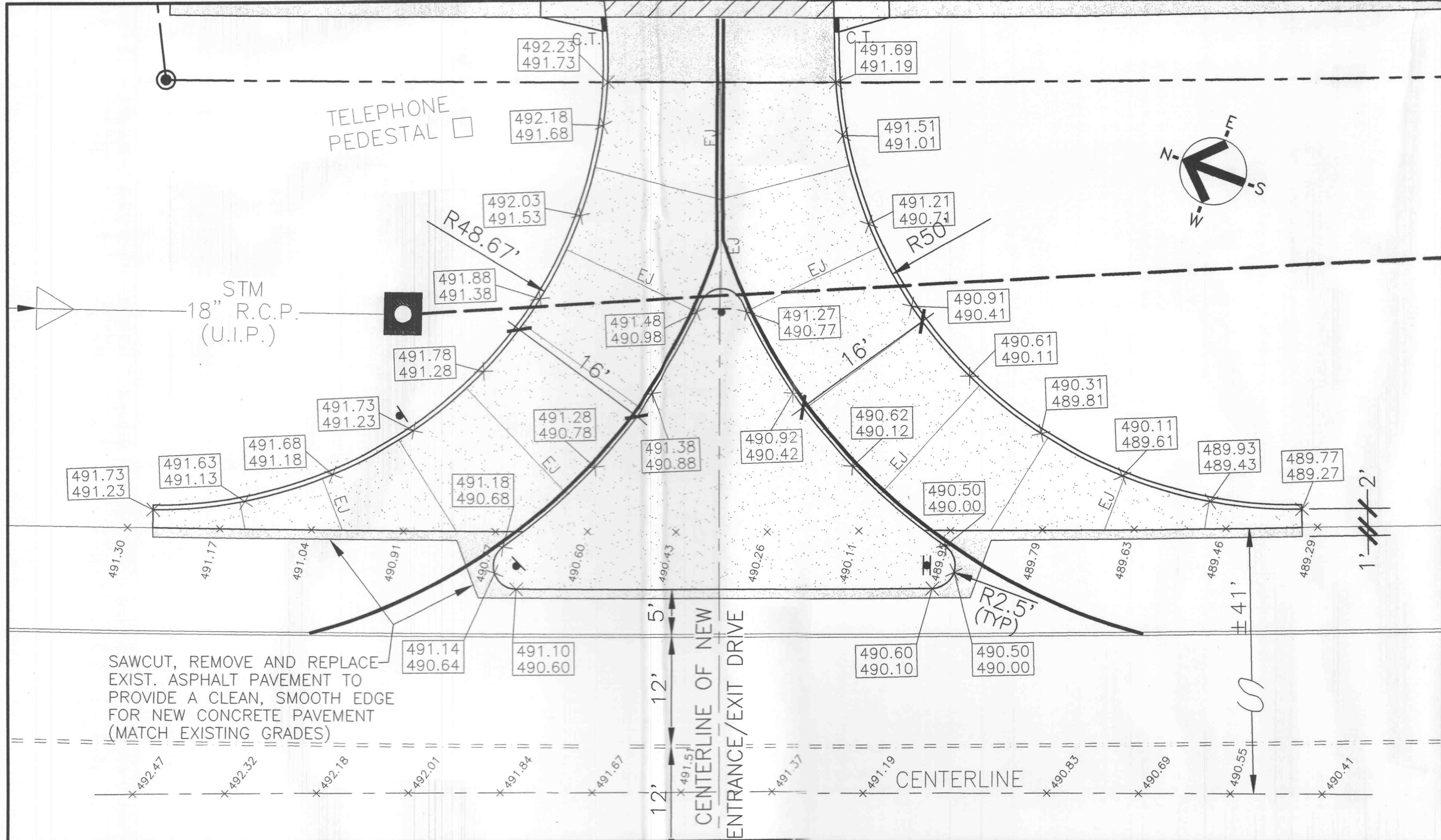

NEW CONCRETE DRIVE APRON GRADES AND JOINT LOCATIONS (MISSOURI STATE HIGHWAY 'K')

SCALE: 1" = 10'-0"

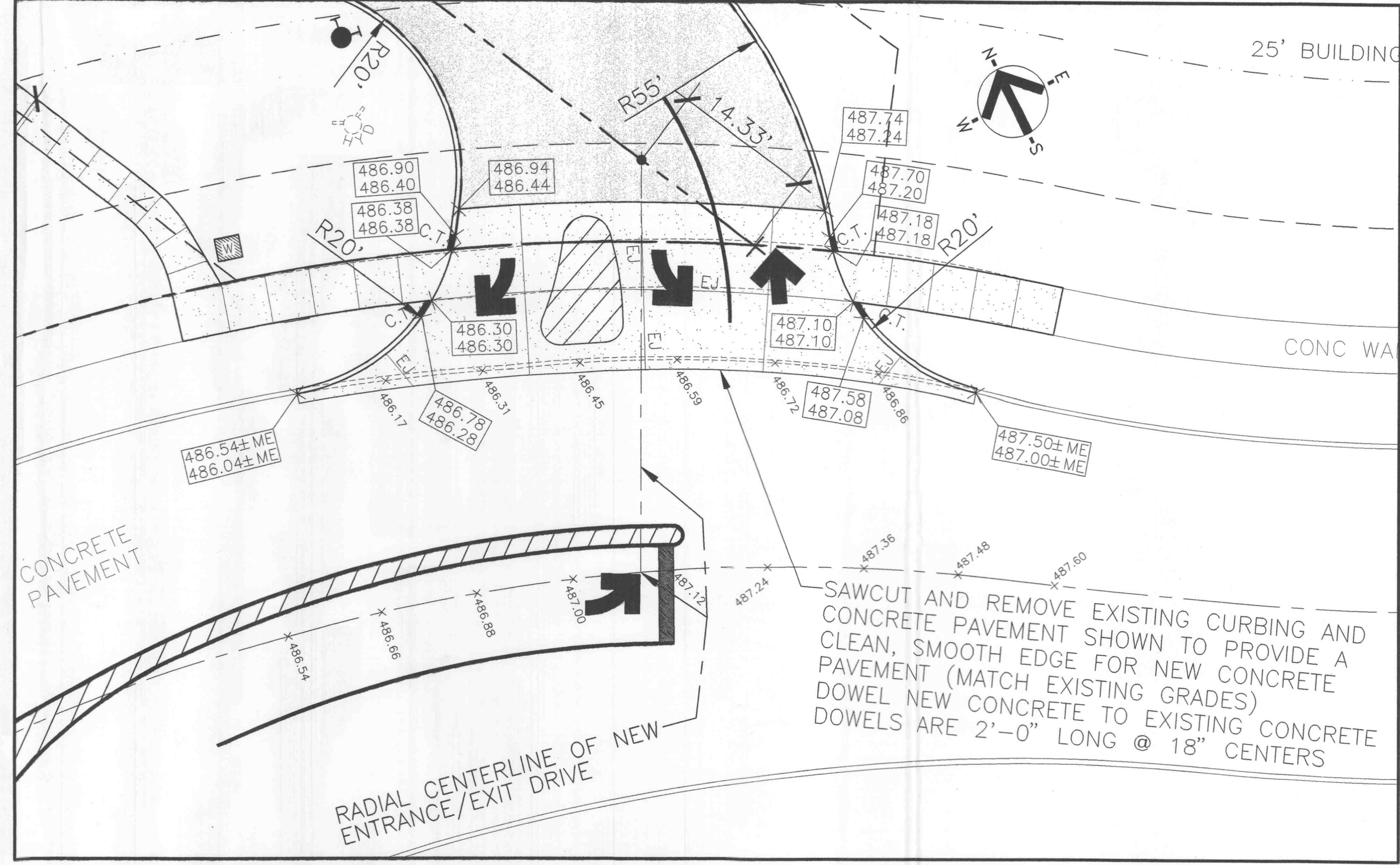

NEW CONCRETE DRIVE APRON GRADES AND JOINT LOCATIONS (PHEASANT MEADOW DRIVE)

SCALE: 1" = 10'-0"



6:FN1907C2-2_3HOT.dwg Rev102
 BORDER=624,0,0,1,7,1,0,1 @ 12,21

A New Building for
FIRST COMMUNITY CREDIT UNION
 O'Fallon, Missouri

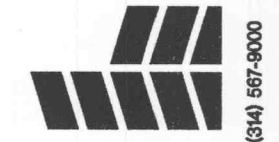

Construction By
HBE Financial Facilities
 A Division of HBE Corporation, 11330 Olive Boulevard, St. Louis, Missouri 63141
 (314) 567-9000

Frederick S. Scott, Architect
Ronald L. Hollander, Architect
 11330 Olive Boulevard, St. Louis, Missouri 63141
 (314) 567-9000

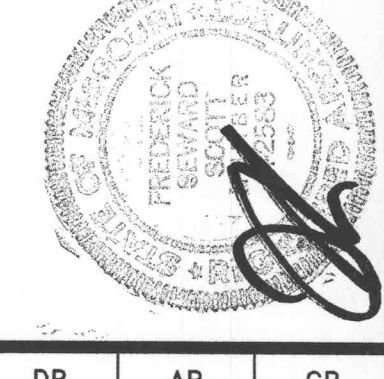
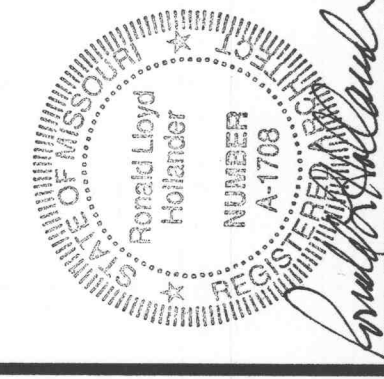

DB	AB	CB
VAB	A	JR

Sheet No. 7 of 8

C2.2
 Civil Site Details
 Date: 4-27-01