

- NOTES:  
STORM SEWER DETAILS PER M.S.D. STANDARDS (MODIFIED):
1. ALL INLETS TO HAVE A 5/8" TRASH BAR IN THE CENTER OF INLET THROAT.
  2. FACE OF TOP STONE SHALL BE 2'-0" BEHIND BACK OF CURB.
  3. A 0.2 FOOT DROP IS REQUIRED THROUGH STORM SEWER STRUCTURES.

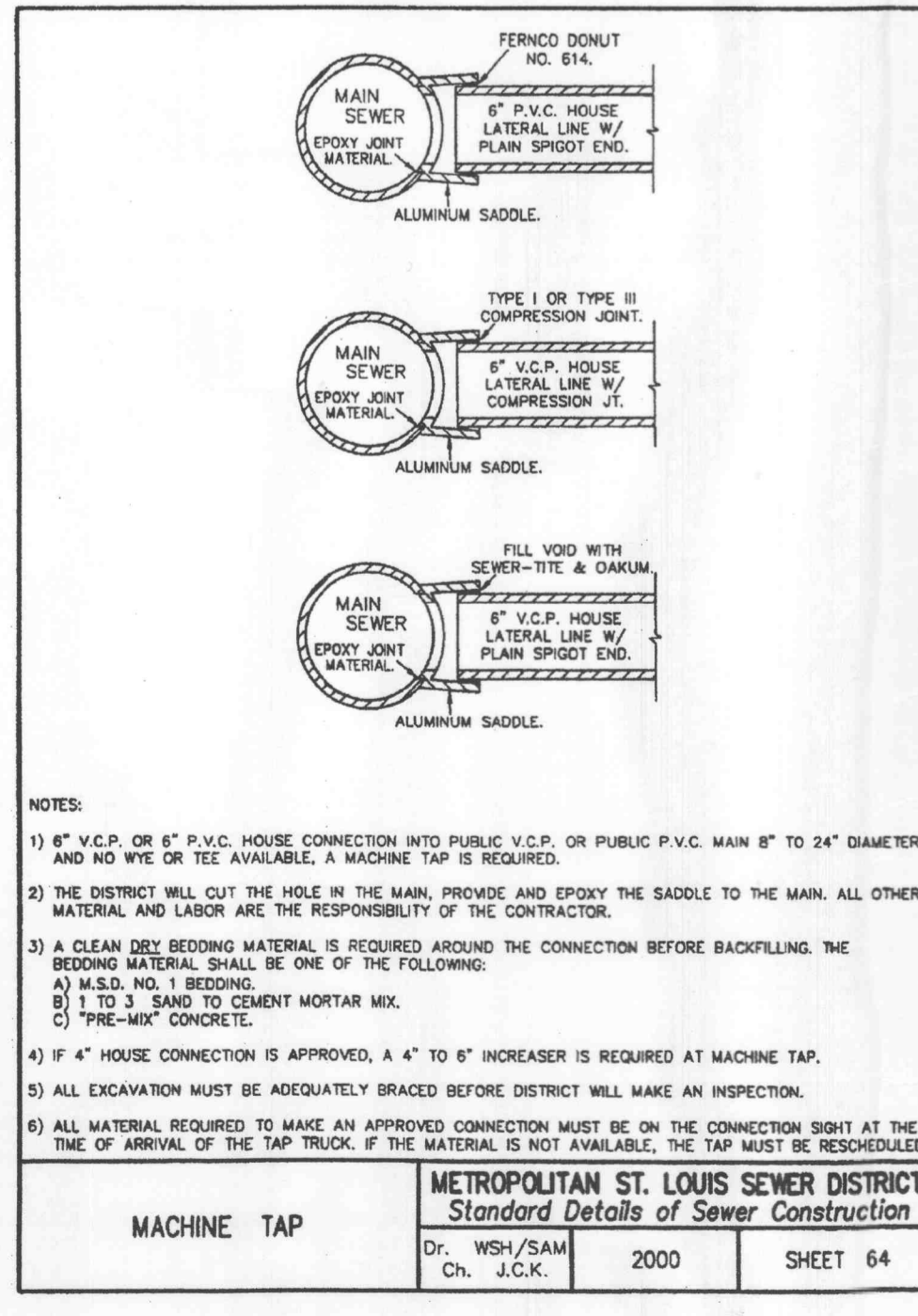
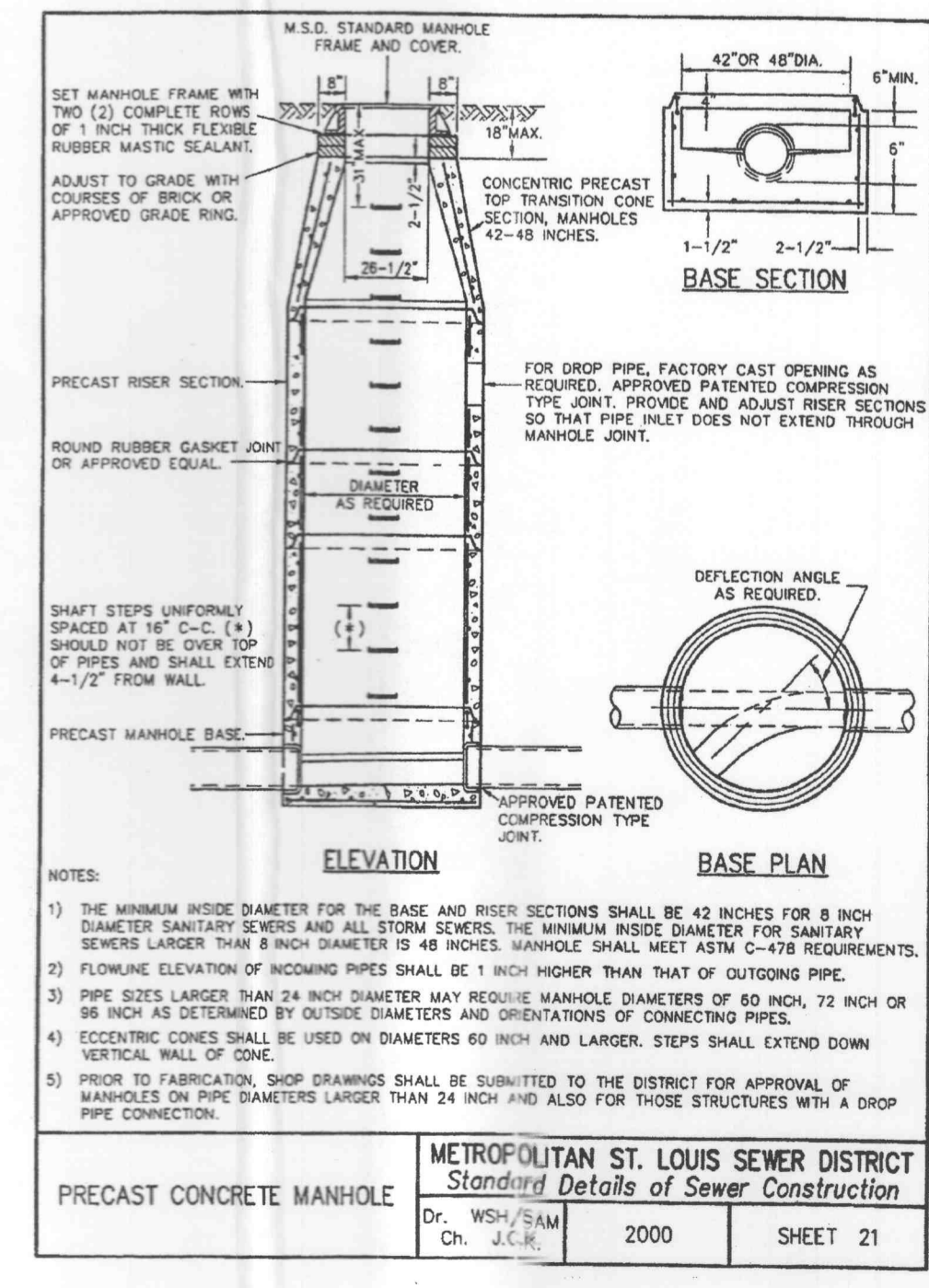
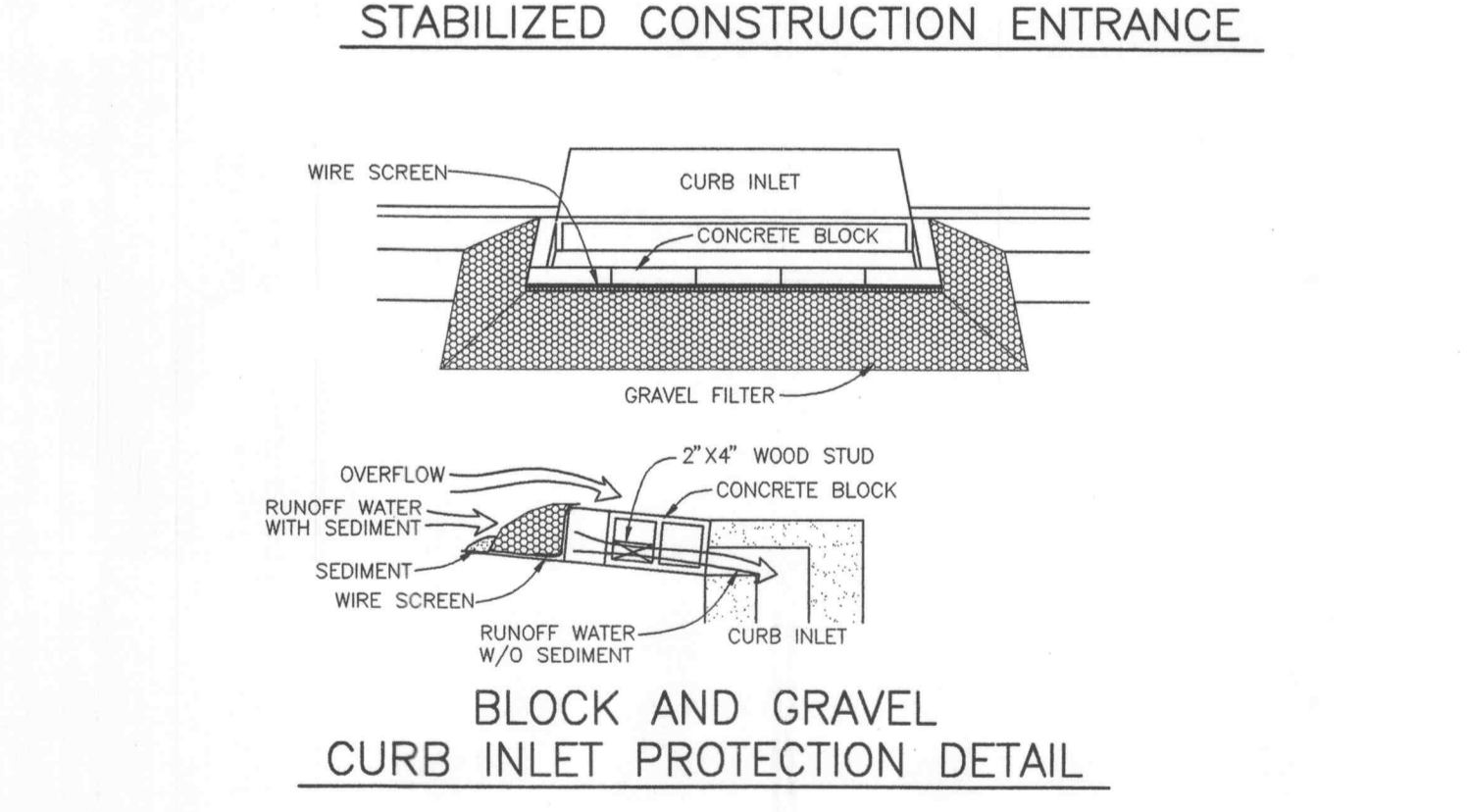
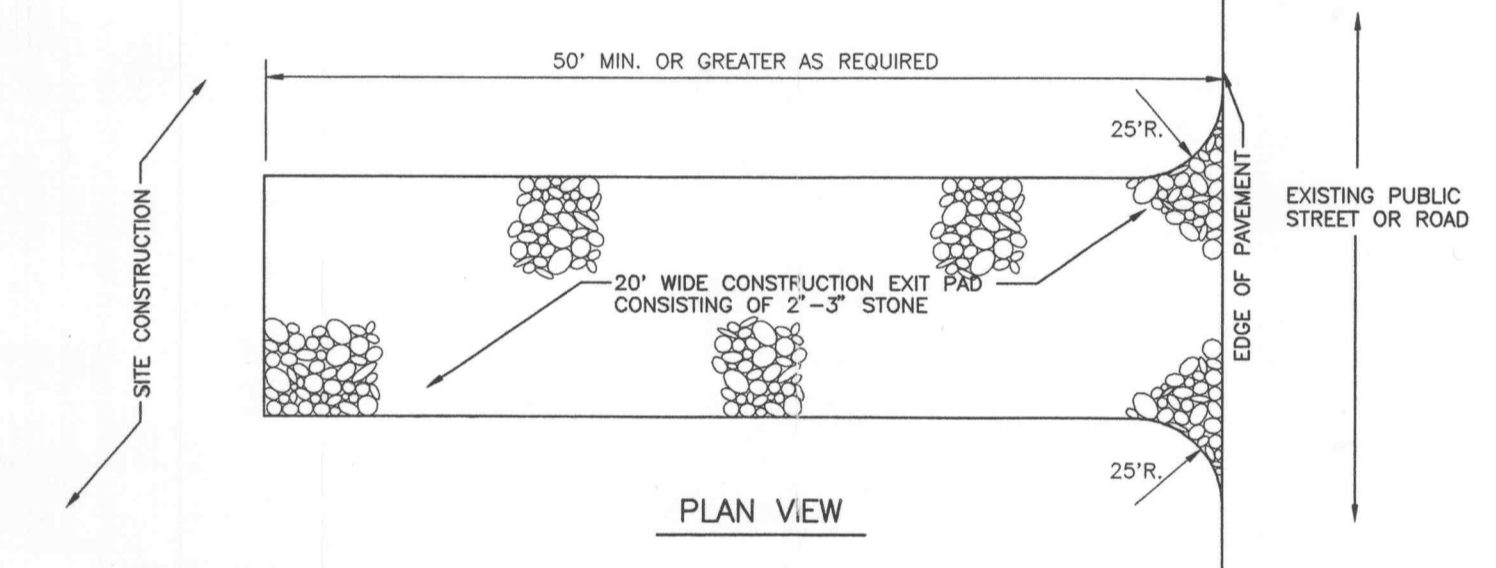
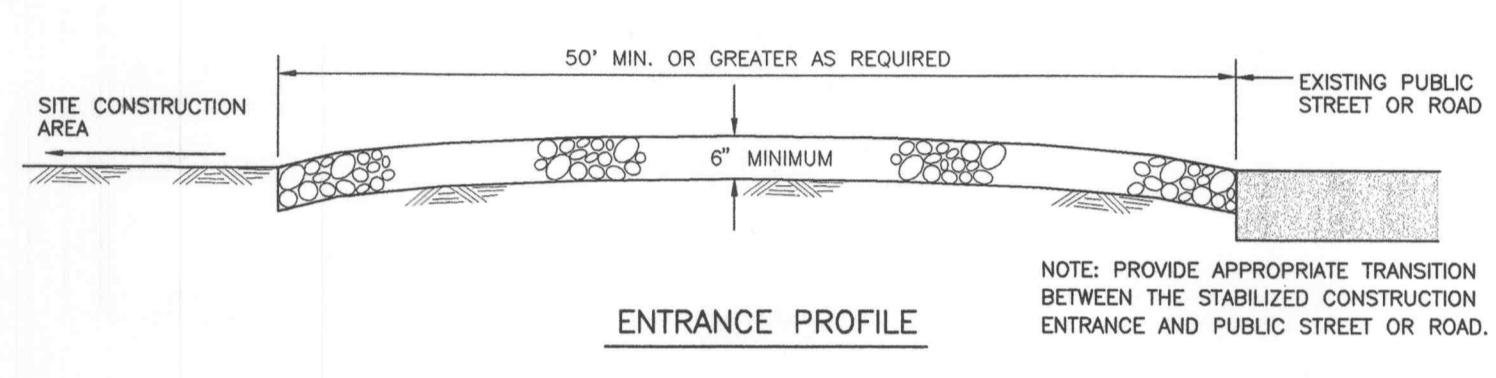
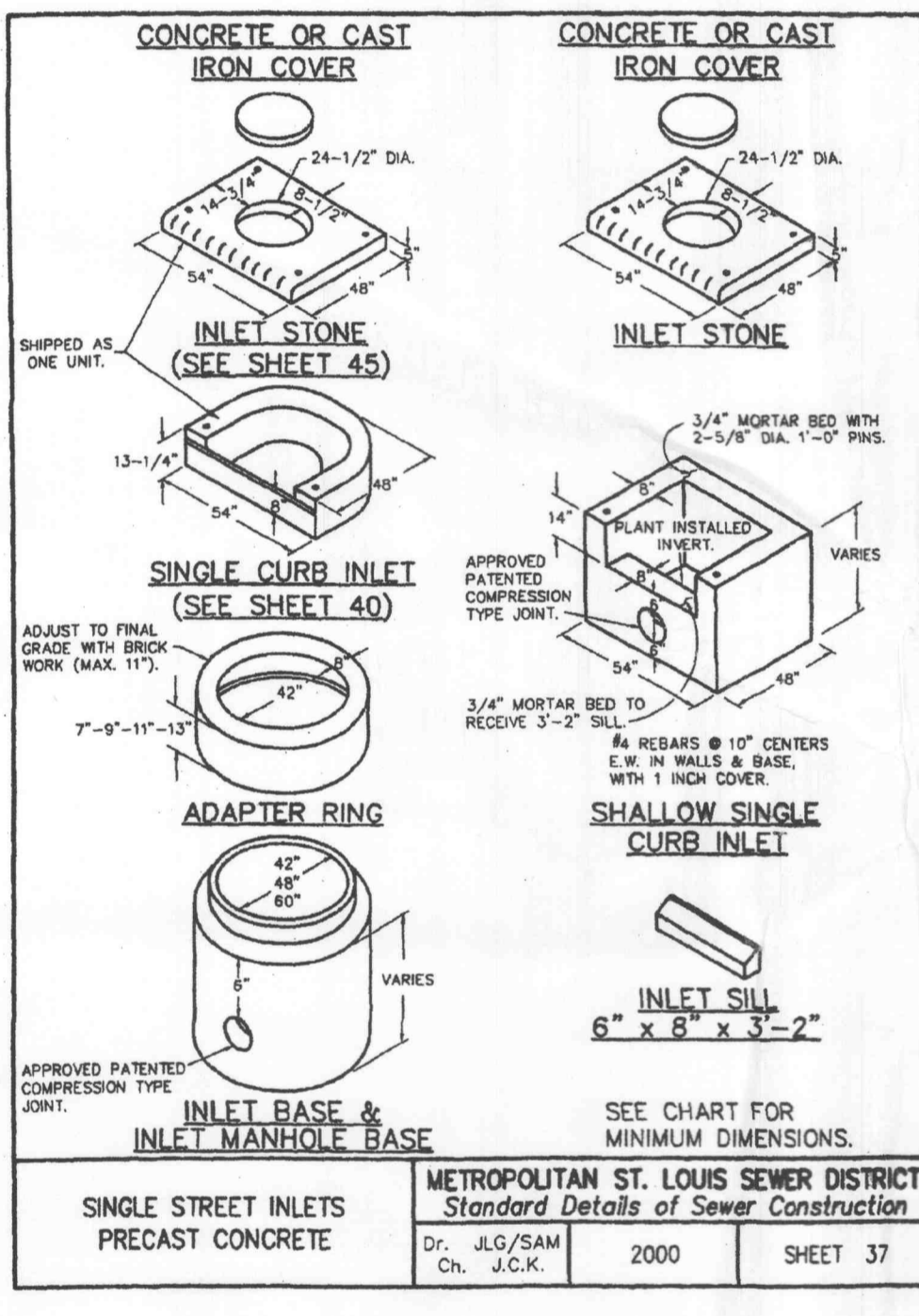
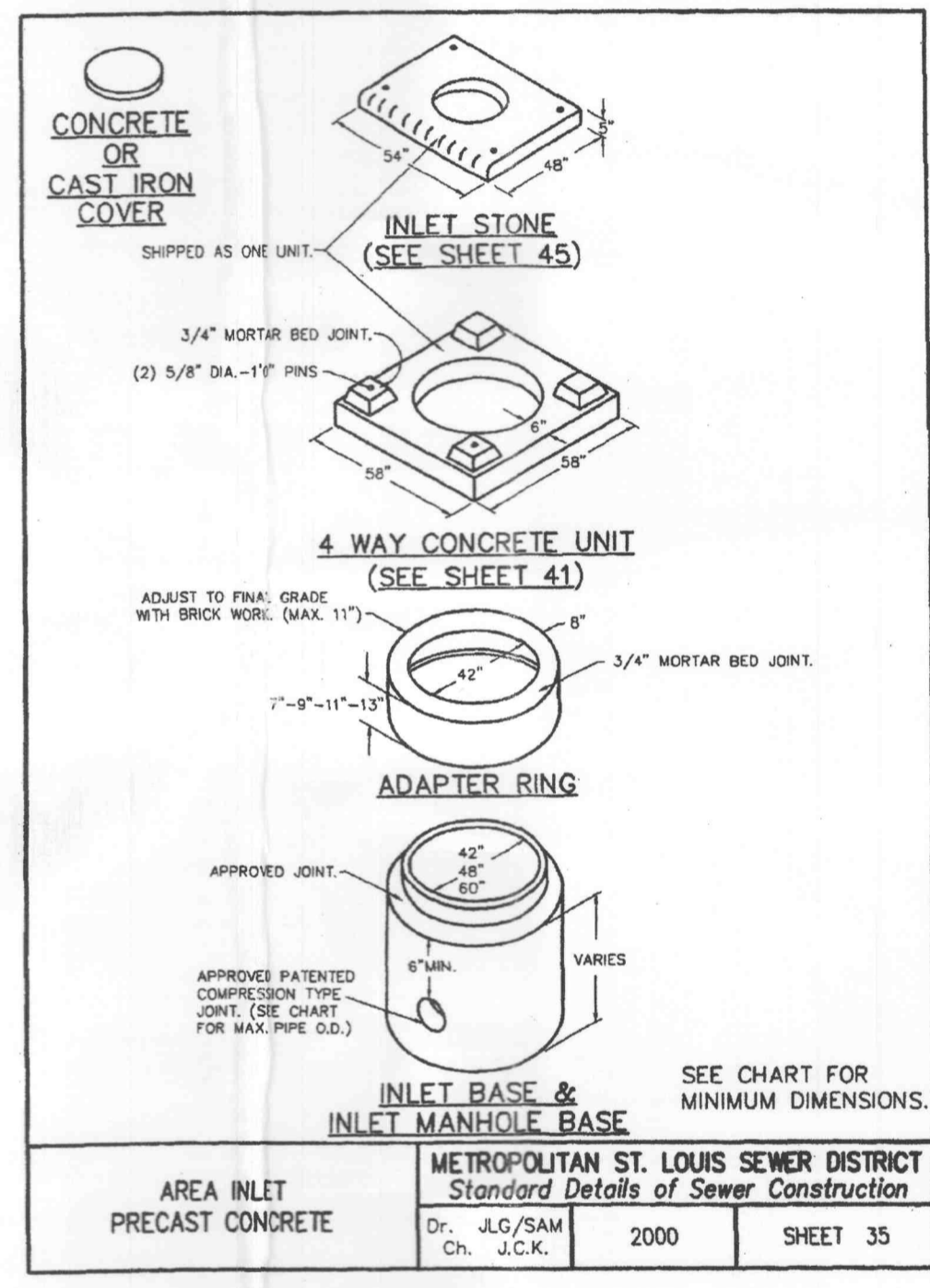
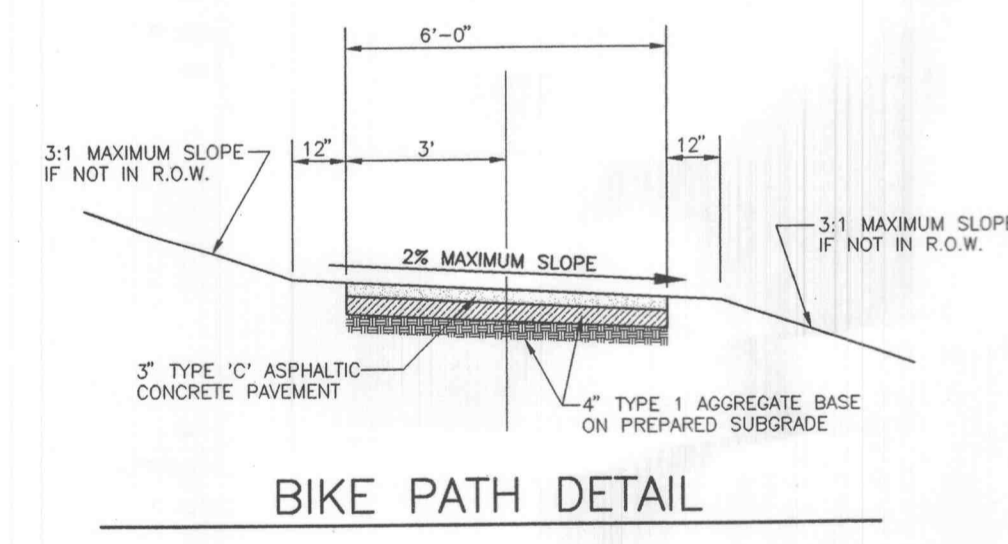

PRECAST CONCRETE MANHOLE	METROPOLITAN ST. LOUIS SEWER DISTRICT Standard Details of Sewer Construction	Dr. WSH/SAM Ch. J.C.K.	2000	SHEET 21
--------------------------	---	---------------------------	------	----------

MACHINE TAP	METROPOLITAN ST. LOUIS SEWER DISTRICT Standard Details of Sewer Construction	Dr. WSH/SAM Ch. J.C.K.	2000	SHEET 64
-------------	---	---------------------------	------	----------

TYPICAL SILTATION CONTROL DEVICES	METROPOLITAN ST. LOUIS SEWER DISTRICT Standard Details of Sewer Construction	Dr. AES/SAM Ch. P.T.K.	2000	SHEET 3
-----------------------------------	---	---------------------------	------	---------

CONCRETE ENCASUREMENT	METROPOLITAN ST. LOUIS SEWER DISTRICT Standard Details of Sewer Construction	Dr. WSH/SAM Ch. J.C.K.	2000	SHEET 8
-----------------------	---	---------------------------	------	---------

PIPE BEDDING CLASS 'C' (FOR ALL PIPE EXCEPT REINFORCED CONCRETE PIPE)	METROPOLITAN ST. LOUIS SEWER DISTRICT Standard Details of Sewer Construction	Dr. WSH/SAM Ch. J.C.K.	2000	SHEET 4
---	---	---------------------------	------	---------

6/19/2007 V.C.2.3, 3/4/07 P.06, HBA/C2, BARBERSBURG24, 7-11-C @ 12.23

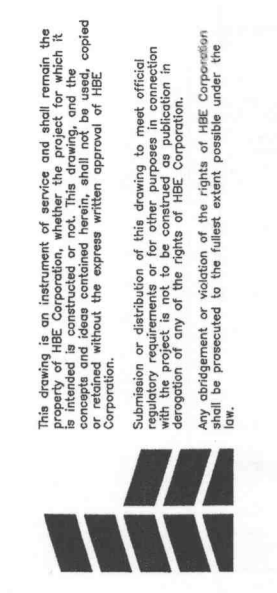

A New Building for  
**FIRST COMMUNITY CREDIT UNION**  
O'Fallon, Missouri

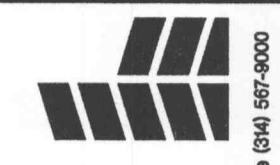

Construction By  
**HBE Financial Facilities**  
A Division of HBE Corporation, 1530 Olive Boulevard, St. Louis, Missouri 63141, Phone (314) 567-9000

**Frederick S. Scott, Architect**  
**Ronald L. Hollander, Architect**

1530 Olive Boulevard, St. Louis, Missouri 63141 (314) 567-9000

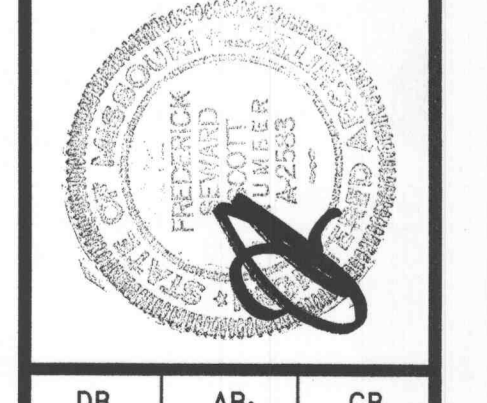
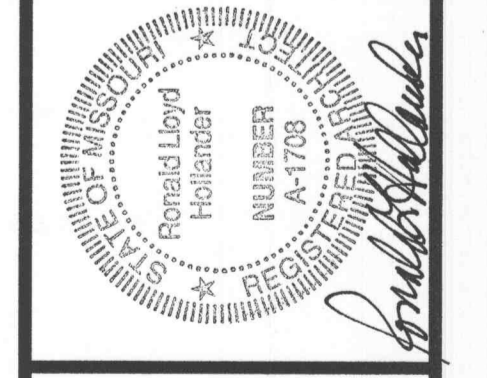
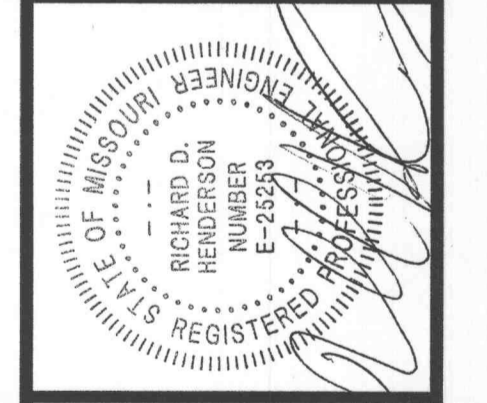

Sheet No. **8** of **8**

**C2.3**

Civil Site Details

Copyright HBE Corporation  
Date: 4-27-01