

LIGHT POLE & BASE
NOT TO SCALE

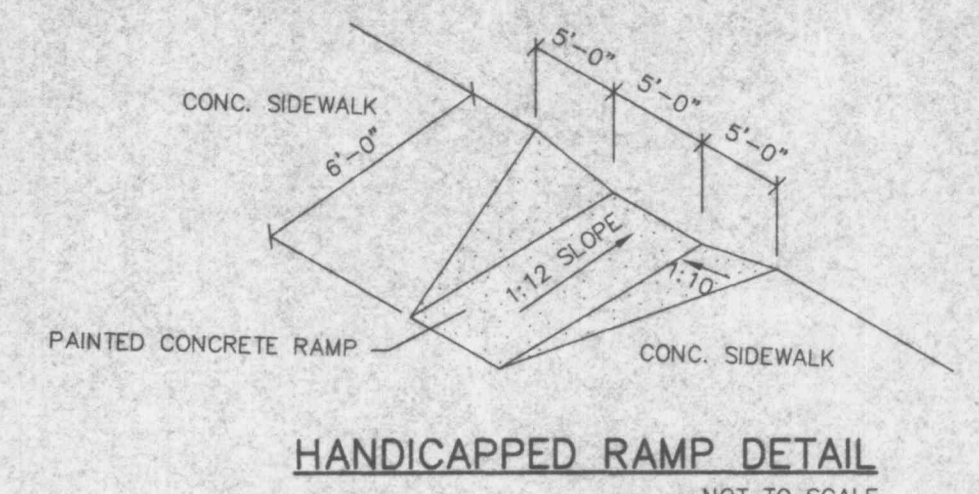

HANDICAPPED RAMP DETAIL
NOT TO SCALE

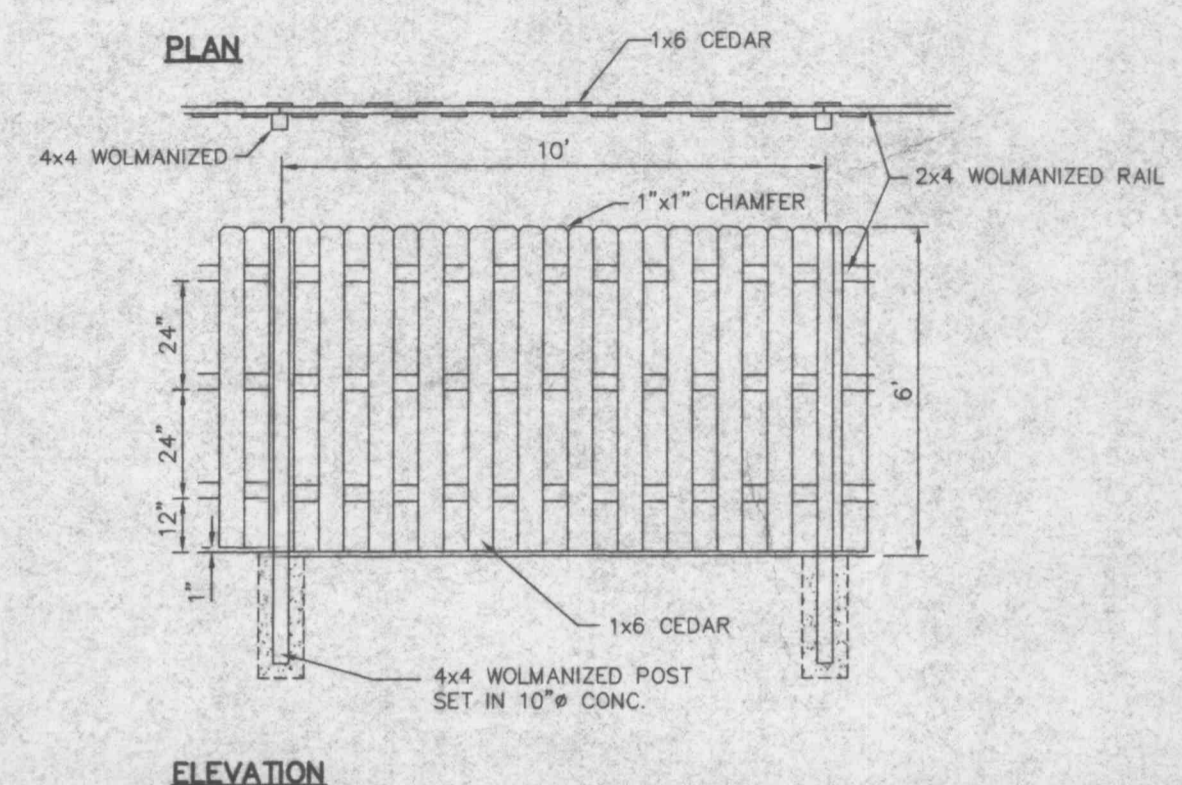

SCREEN FENCE DETAIL
NOT TO SCALE



HANDICAP PARKING SIGN
12\"/>

HANDICAP PARKING SIGN
NOT TO SCALE

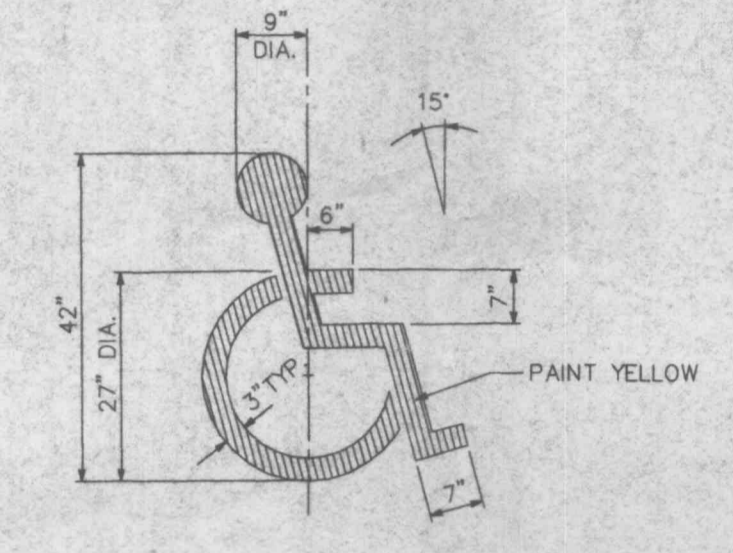

PAINTED HANDICAPPED PARKING SYMBOL
NOT TO SCALE

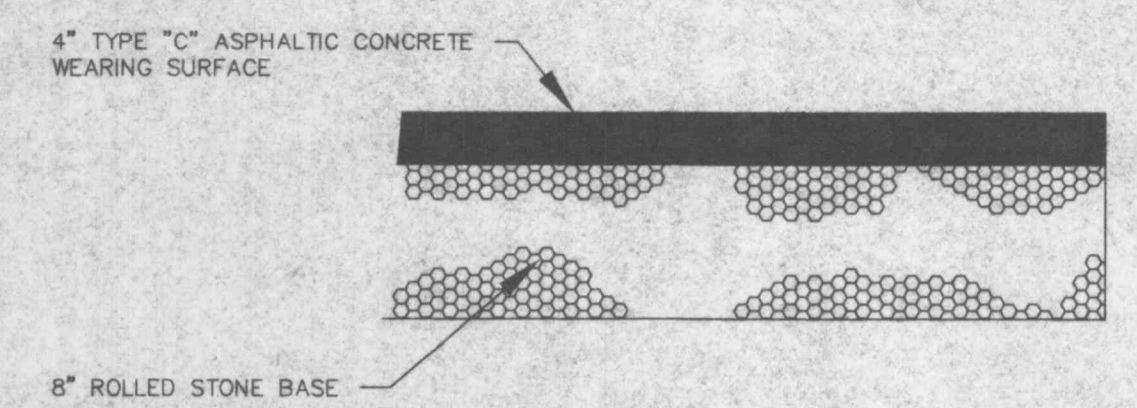

ASPHALT PAVEMENT DETAIL
NOT TO SCALE

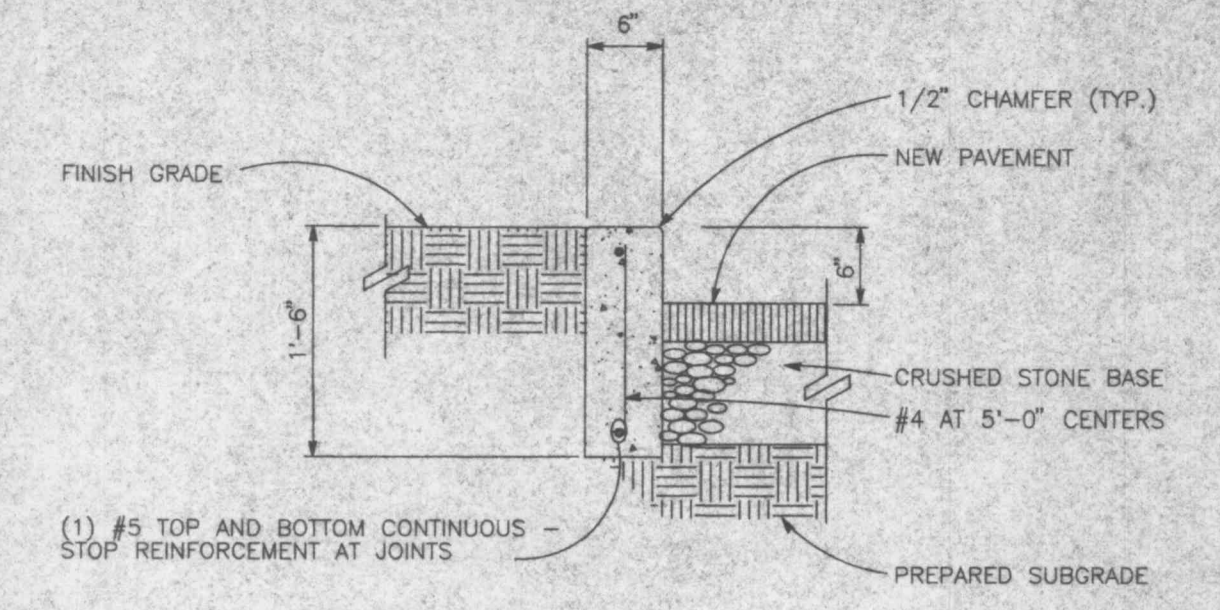

CONCRETE CURB DETAIL
NOT TO SCALE

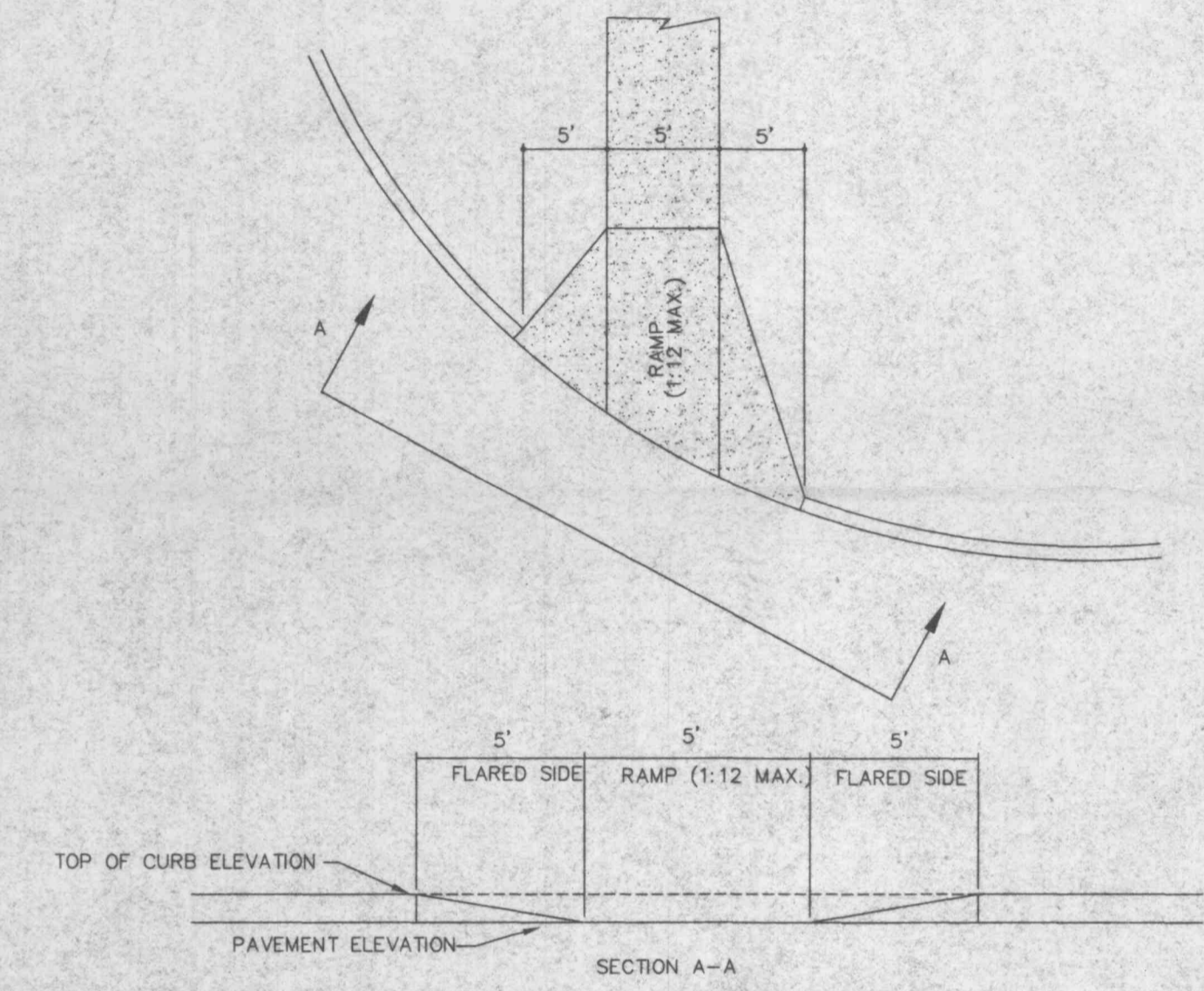

HANDICAPPED RAMP DETAIL
NOT TO SCALE

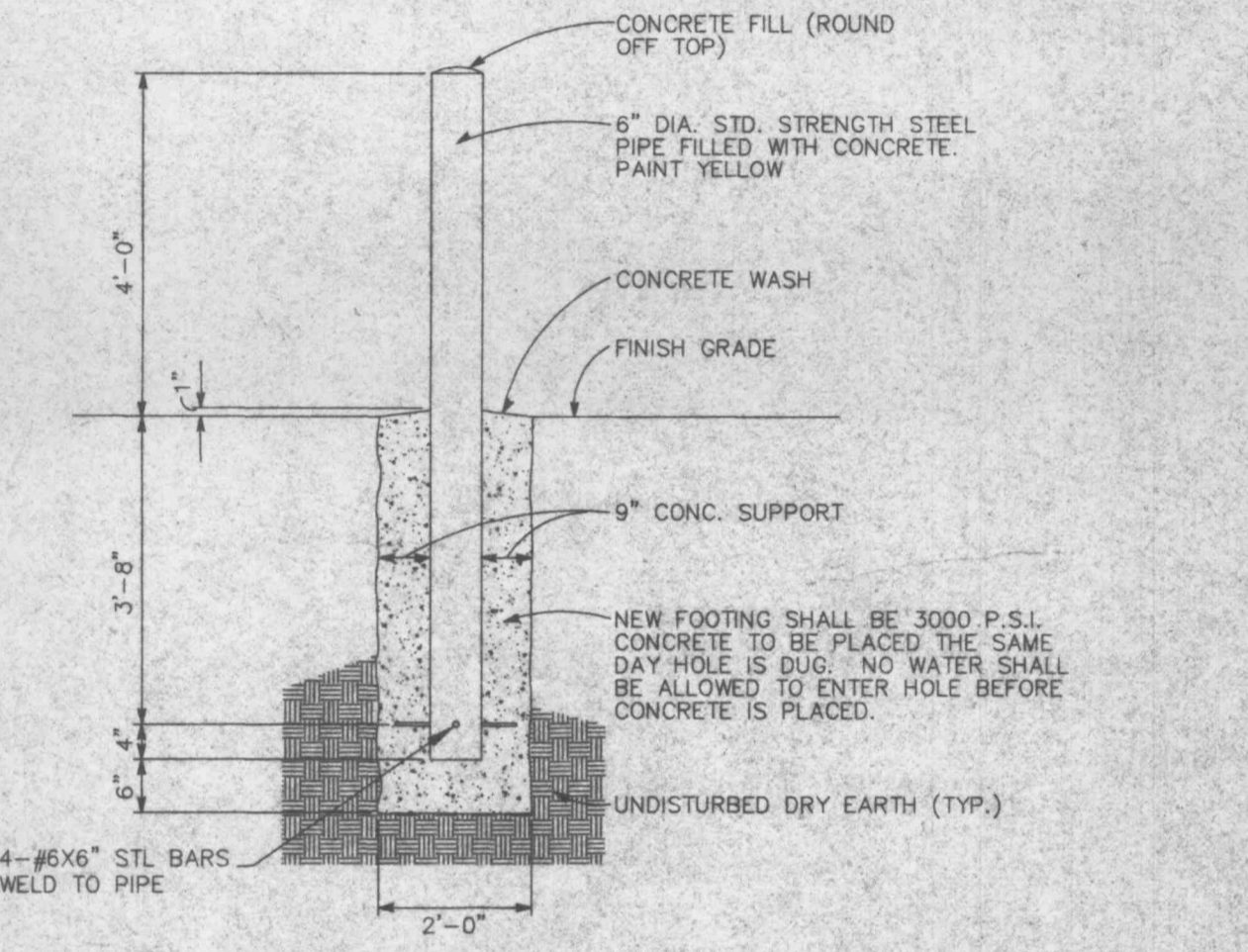

PIPE BOLLARD DETAIL
NOT TO SCALE

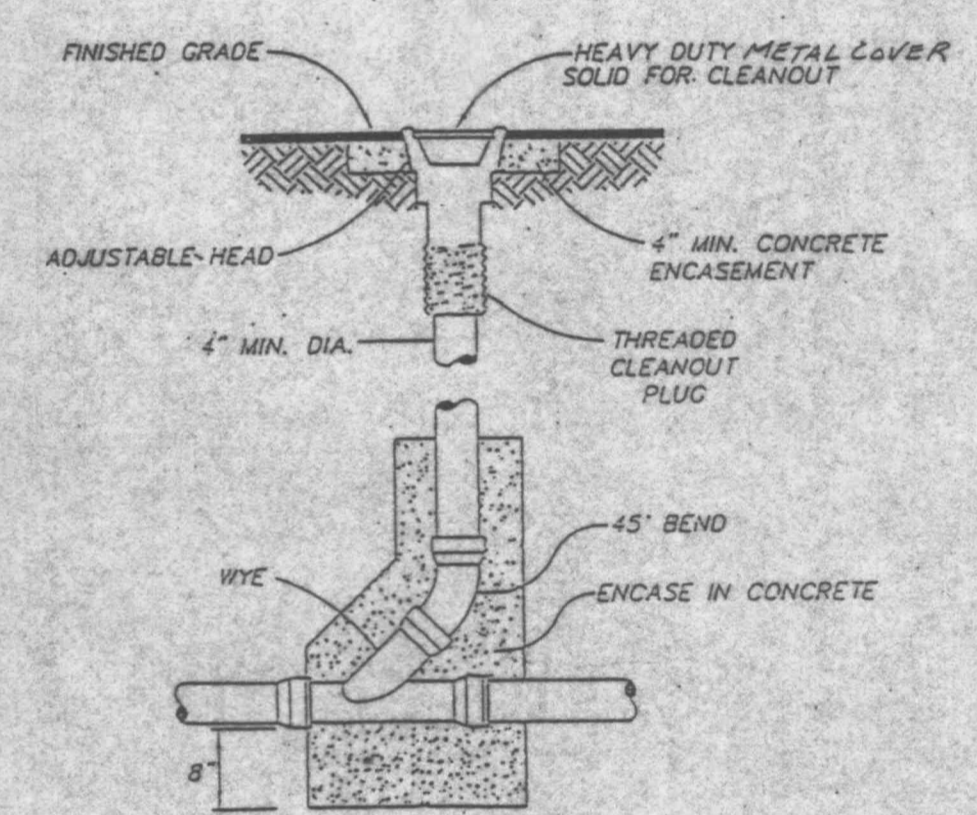

CLEANOUT DETAIL
N.T.S.

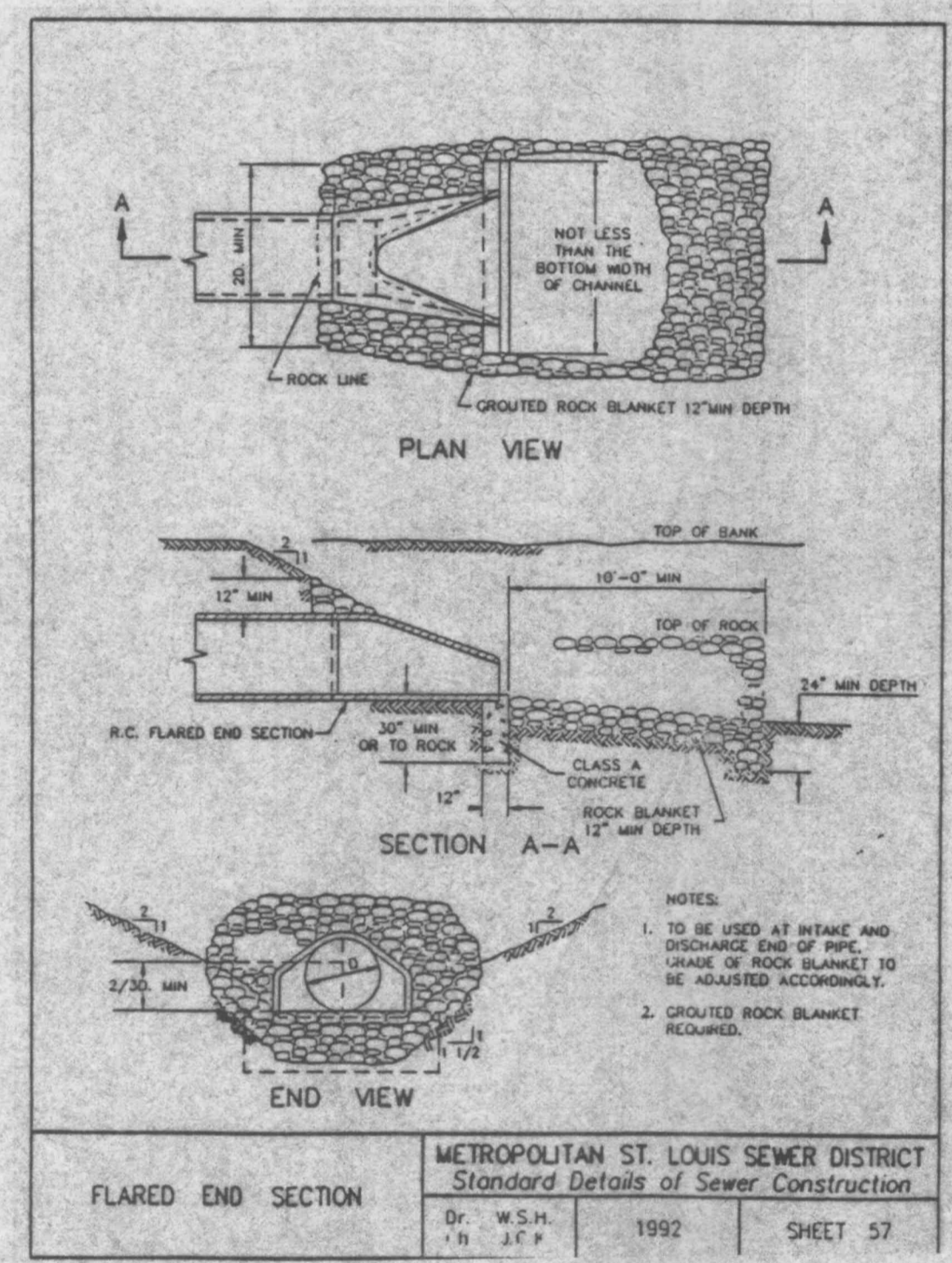

SILTATION FENCE DETAIL
NOT TO SCALE

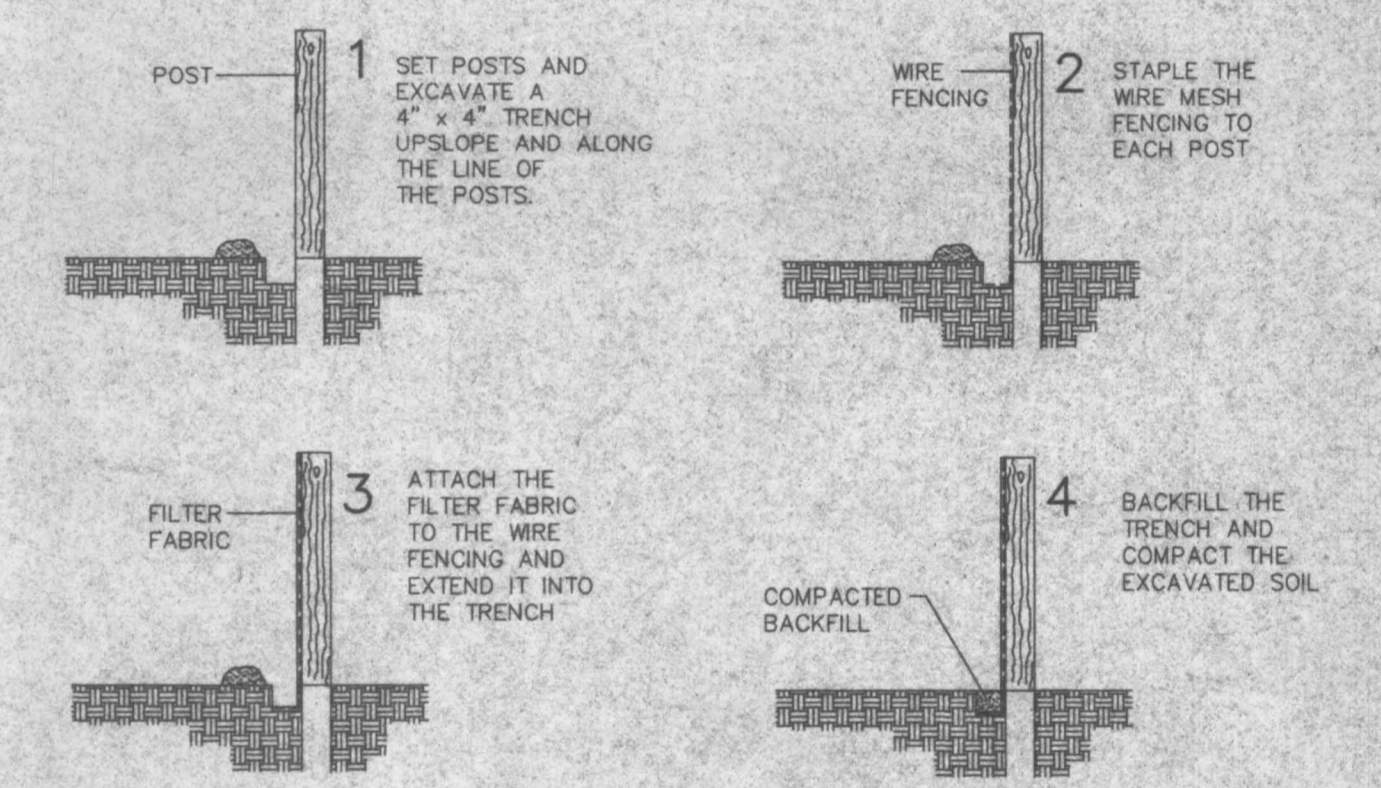

1. FILTER BARRIERS SHALL BE INSPECTED IMMEDIATELY AFTER EACH RAINFALL AND AT LEAST DAILY DURING PROLONGED RAINFALL. ANY REQUIRED REPAIRS SHALL BE MADE IMMEDIATELY.
2. SHOULD THE FABRIC DECOMPOSE OR BECOME INEFFECTIVE PRIOR TO THE END OF THE EXPECTED USABLE LIFE AND THE BARRIER STILL BE NECESSARY, THE FABRIC SHALL BE REPLACED PROMPTLY.
3. SEDIMENT DEPOSITS SHOULD BE REMOVED AFTER EACH STORM EVENT. THEY MUST BE REMOVED WHEN DEPOSITS REACH APPROXIMATELY HALF THE HEIGHT OF THE BARRIER.
4. ANY SEDIMENT DEPOSITS REMAINING IN PLACE AFTER THE SILT FENCE OR FILTER BARRIER IS NO LONGER REQUIRED SHALL BE DRESSED TO CONFORM WITH THE EXISTING GRADE, PREPARED AND SEDED.

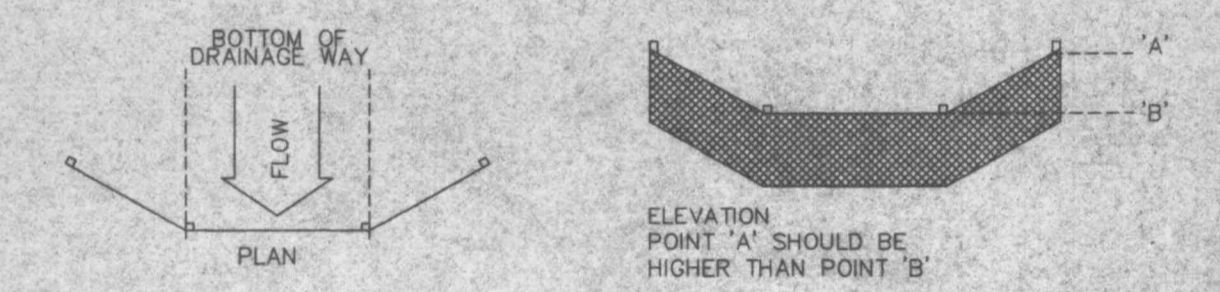

SILTATION FENCE DETAIL
NOT TO SCALE

NEW HIGHWAY "K" ELEMENTARY SCHOOL
for
FORT ZUMWALT SCHOOL DISTRICT

ISSUED
11-14-97
BID PACKAGE No. 2

DISCLAIMER OF RESPONSIBILITY
I hereby specify that the documents intended to be submitted by my firm are limited to this sheet, and I hereby disclaim any responsibility for all other drawings, specifications, estimates, reports or other documents or instruments reading in or intended to be used for any part or parts of the architectural or engineering project or survey.

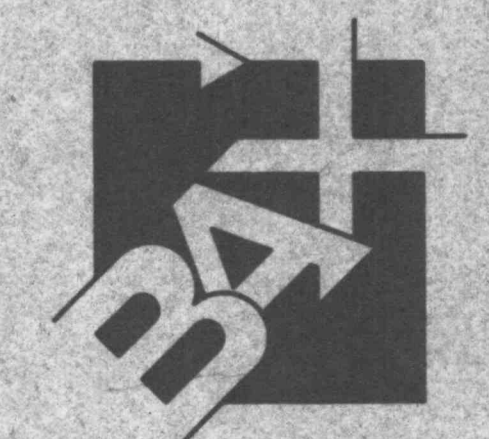

**ENGINEERING
PLANNING
SURVEYING**
1052 South Cloverleaf Drive
St. Peters, MO. 63376-6445
314-928-5552
FAX 928-1718

Proj. No. 970334
Date: 11-14-97
Plot: 11-17-97

C-7

Copyright 1997
DMA Engineering Company, Inc.
All Rights Reserved

DMA Design
A Division of The DMA Corporation
architects engineers construction managers
202 Transit St. Charles, Missouri 63301