

INSIDE FOULWATER DROP MANHOLE (FOR FREE-FALL) METROPOLITAN ST. LOUIS SEWER DISTRICT Standard Details of Sewer Construction SHEET 19

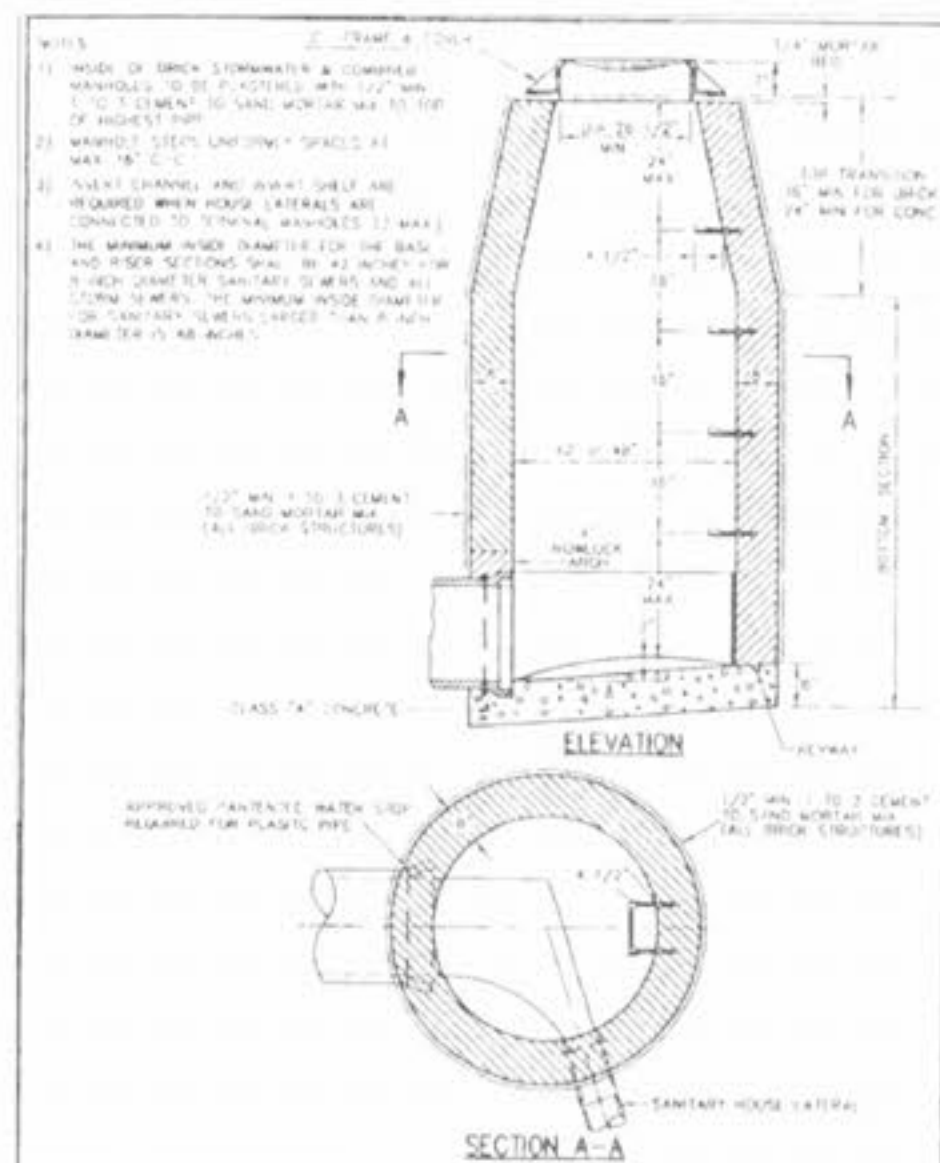

TERMINAL MANHOLE METROPOLITAN ST. LOUIS SEWER DISTRICT Standard Details of Sewer Construction SHEET 20

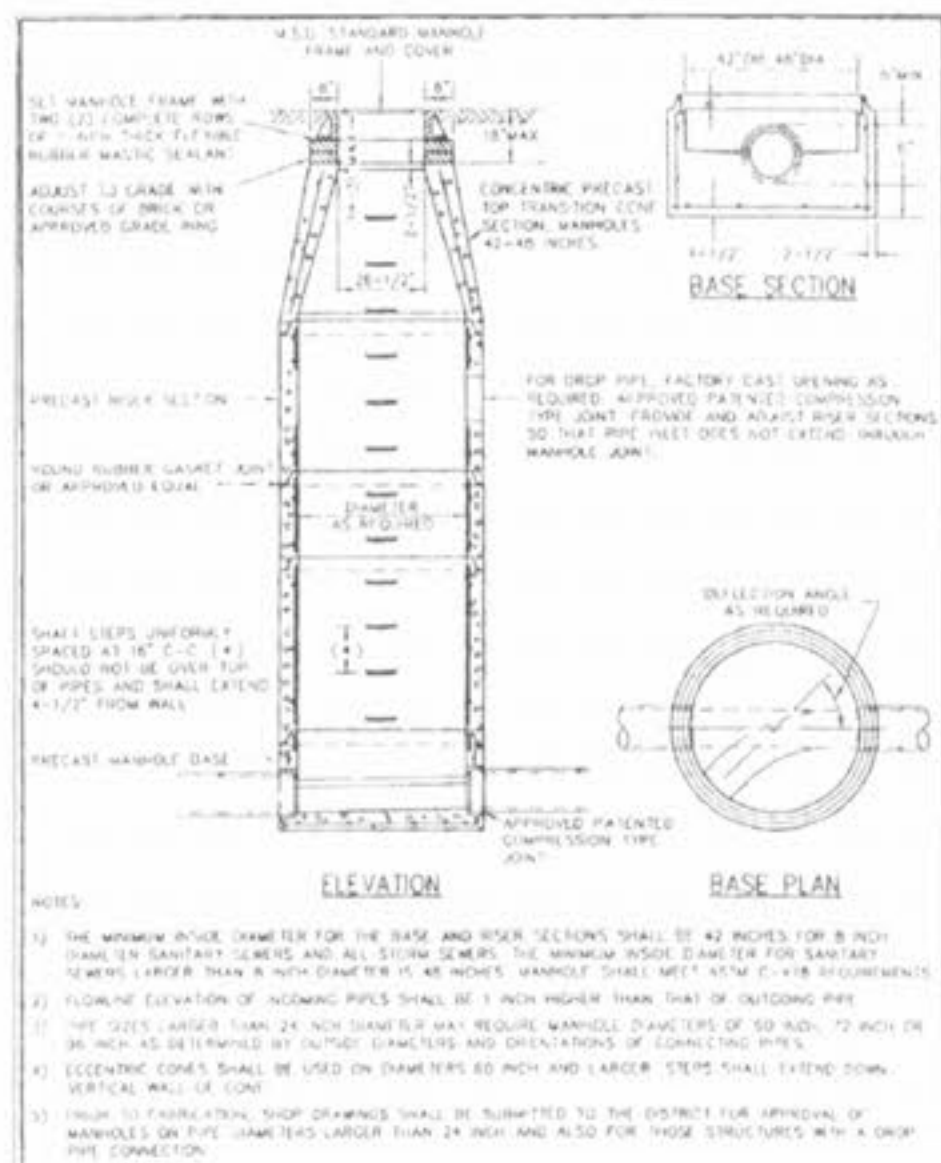

PRECAST CONCRETE MANHOLE METROPOLITAN ST. LOUIS SEWER DISTRICT Standard Details of Sewer Construction SHEET 21

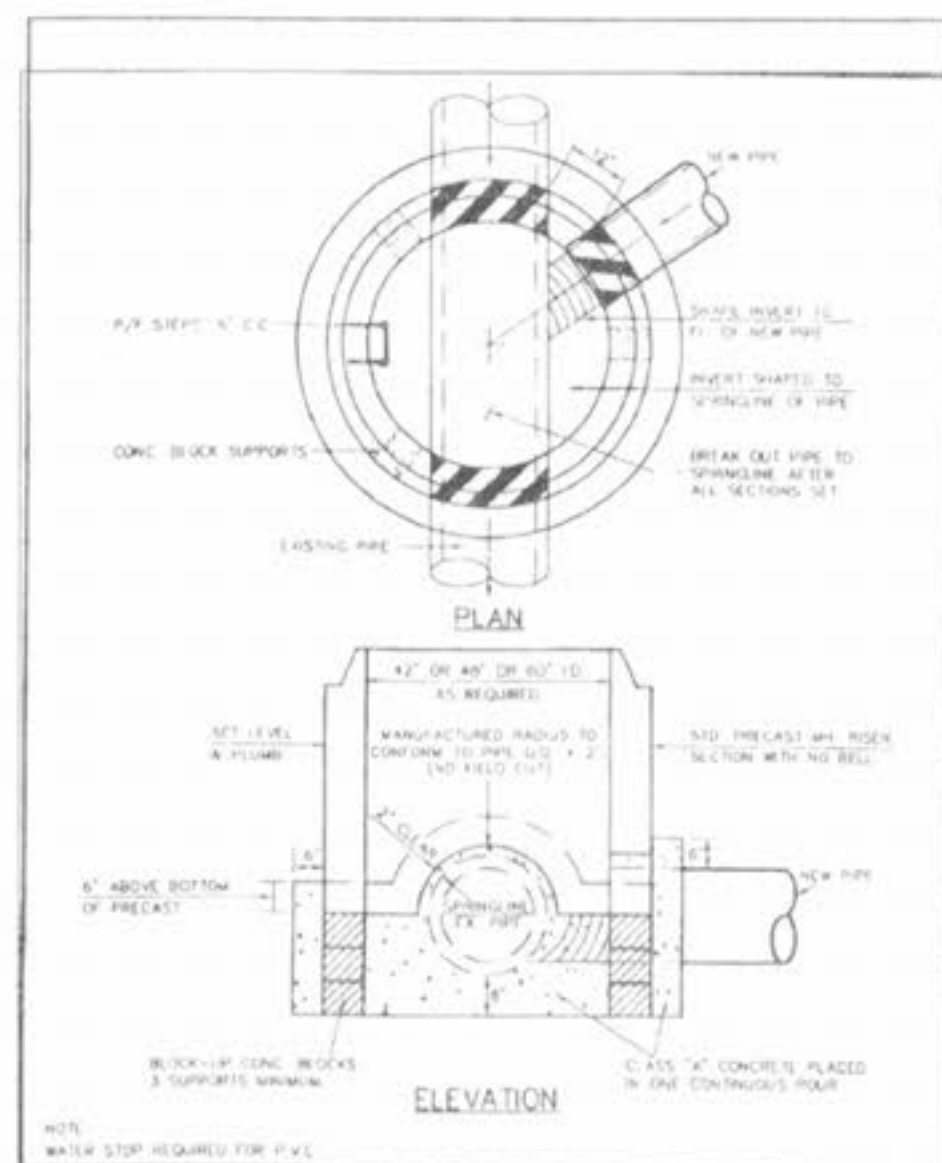

PRECAST MANHOLE ON EXIST. PIPE W/CONTINUOUS FLOW ONLY METROPOLITAN ST. LOUIS SEWER DISTRICT Standard Details of Sewer Construction SHEET 22

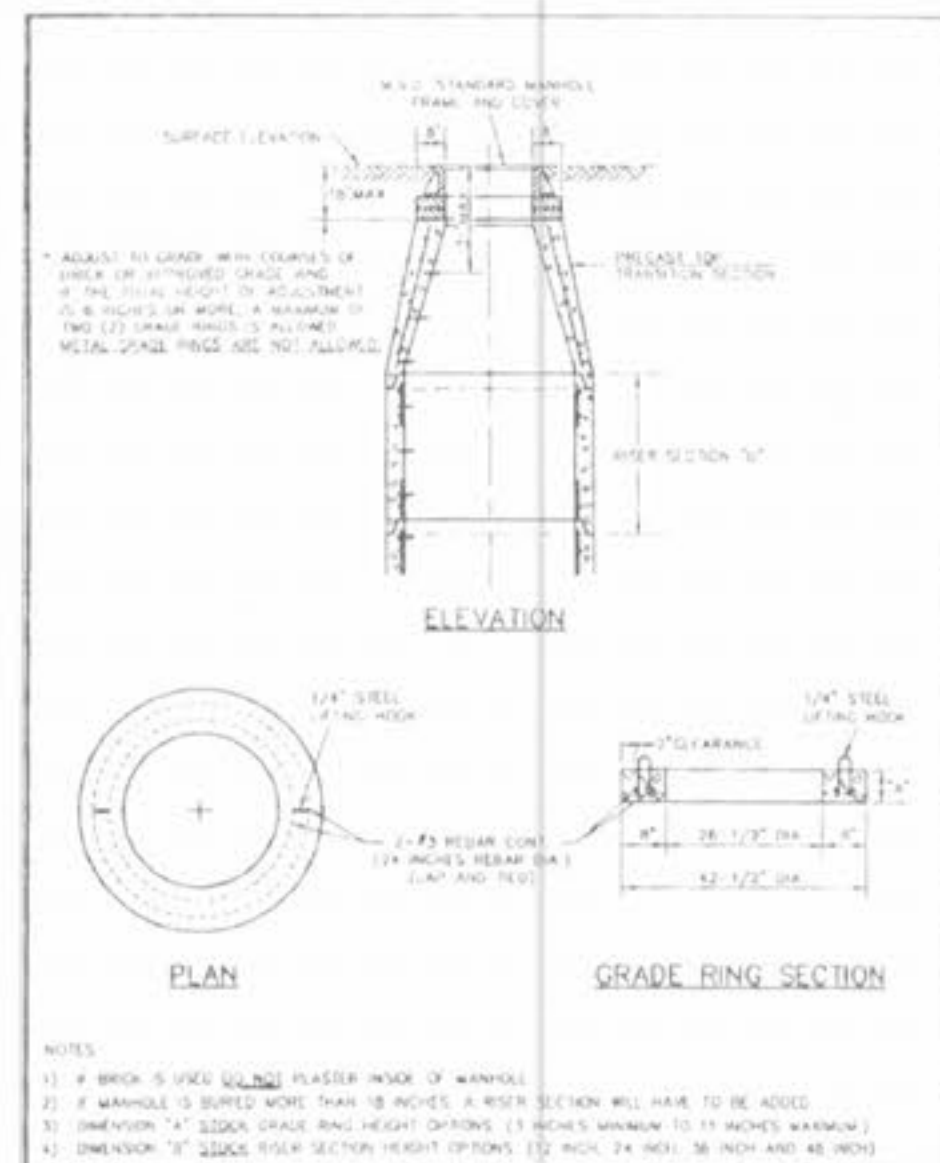

ADJUST TO GRADE METROPOLITAN ST. LOUIS SEWER DISTRICT Standard Details of Sewer Construction SHEET 23

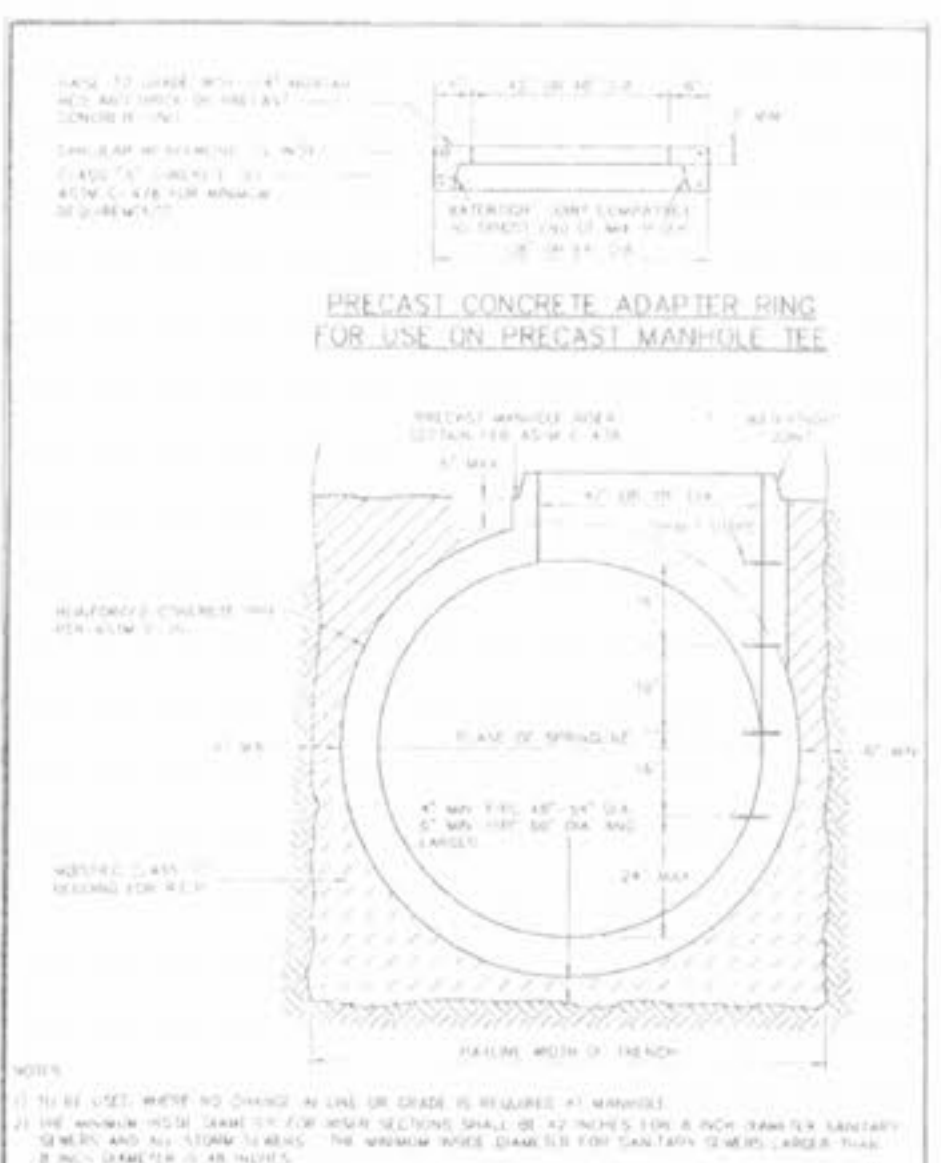

TYPICAL PRECAST MANHOLE TEE FOR REINFORCED CONCRETE PIPE SEWERS 48 INCH AND LARGER IN DIAMETER METROPOLITAN ST. LOUIS SEWER DISTRICT Standard Details of Sewer Construction SHEET 24

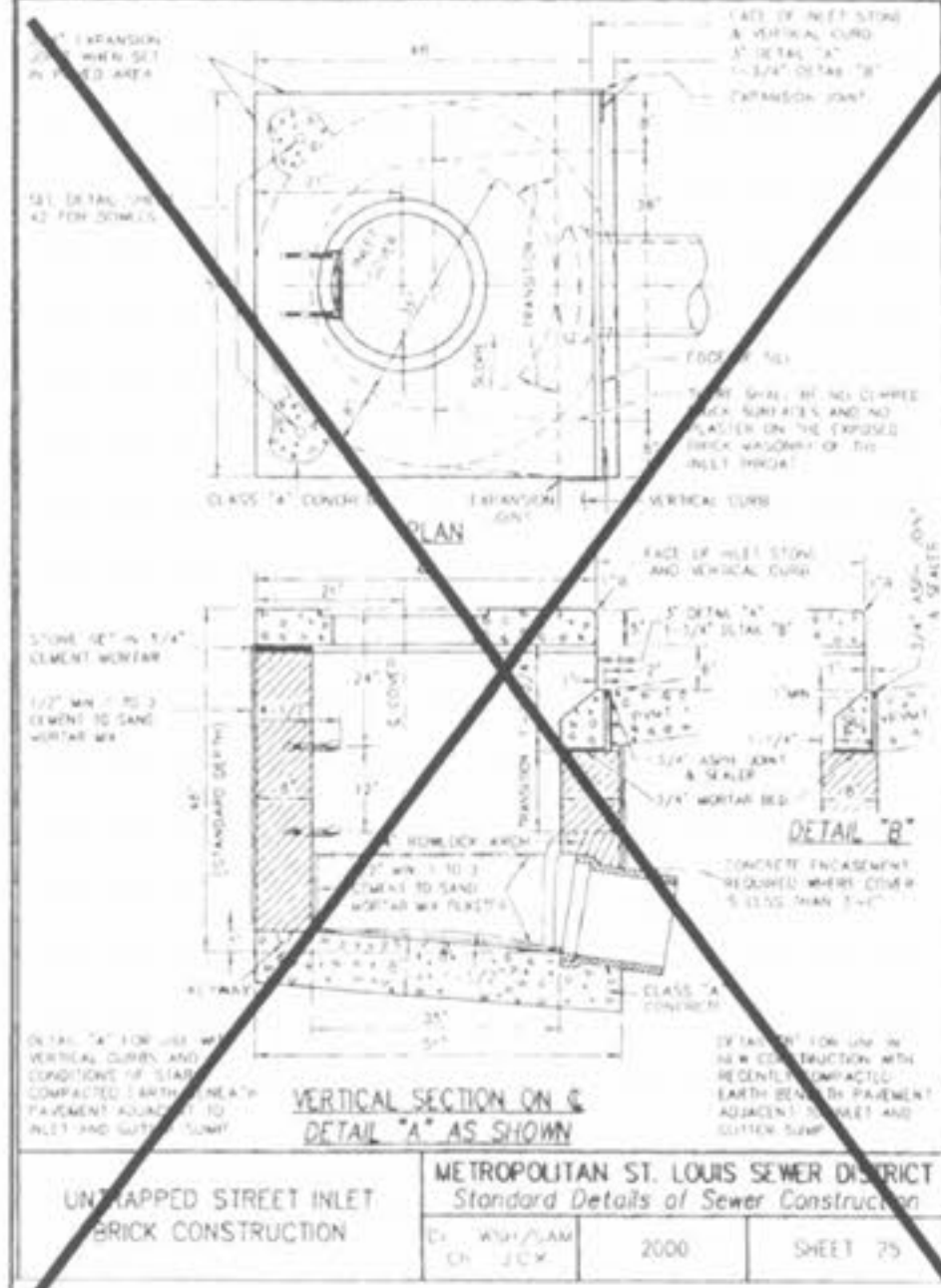

UNTRAPPED STREET INLET BRICK CONSTRUCTION METROPOLITAN ST. LOUIS SEWER DISTRICT Standard Details of Sewer Construction SHEET 25

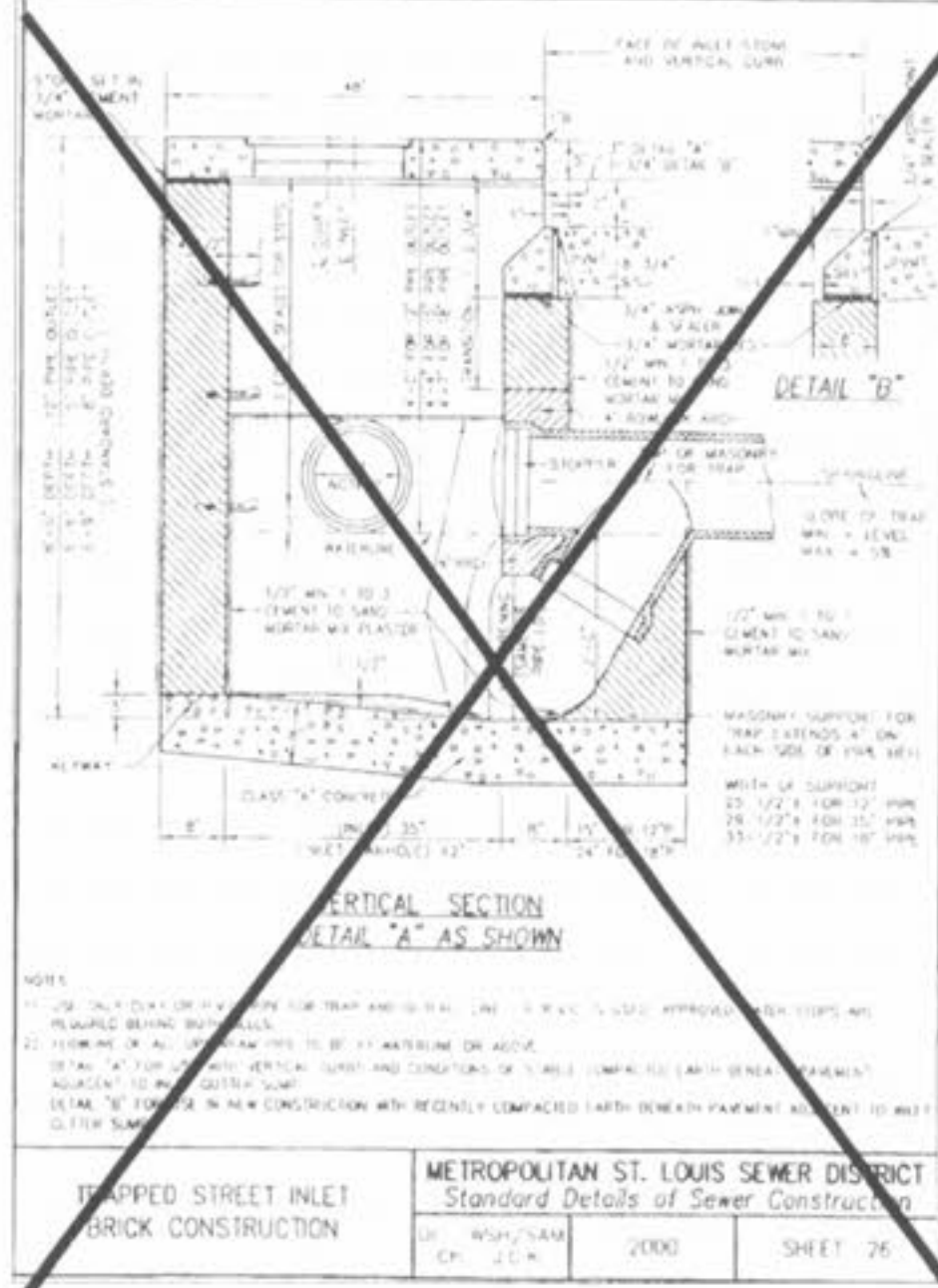

TRAPPED STREET INLET BRICK CONSTRUCTION METROPOLITAN ST. LOUIS SEWER DISTRICT Standard Details of Sewer Construction SHEET 26

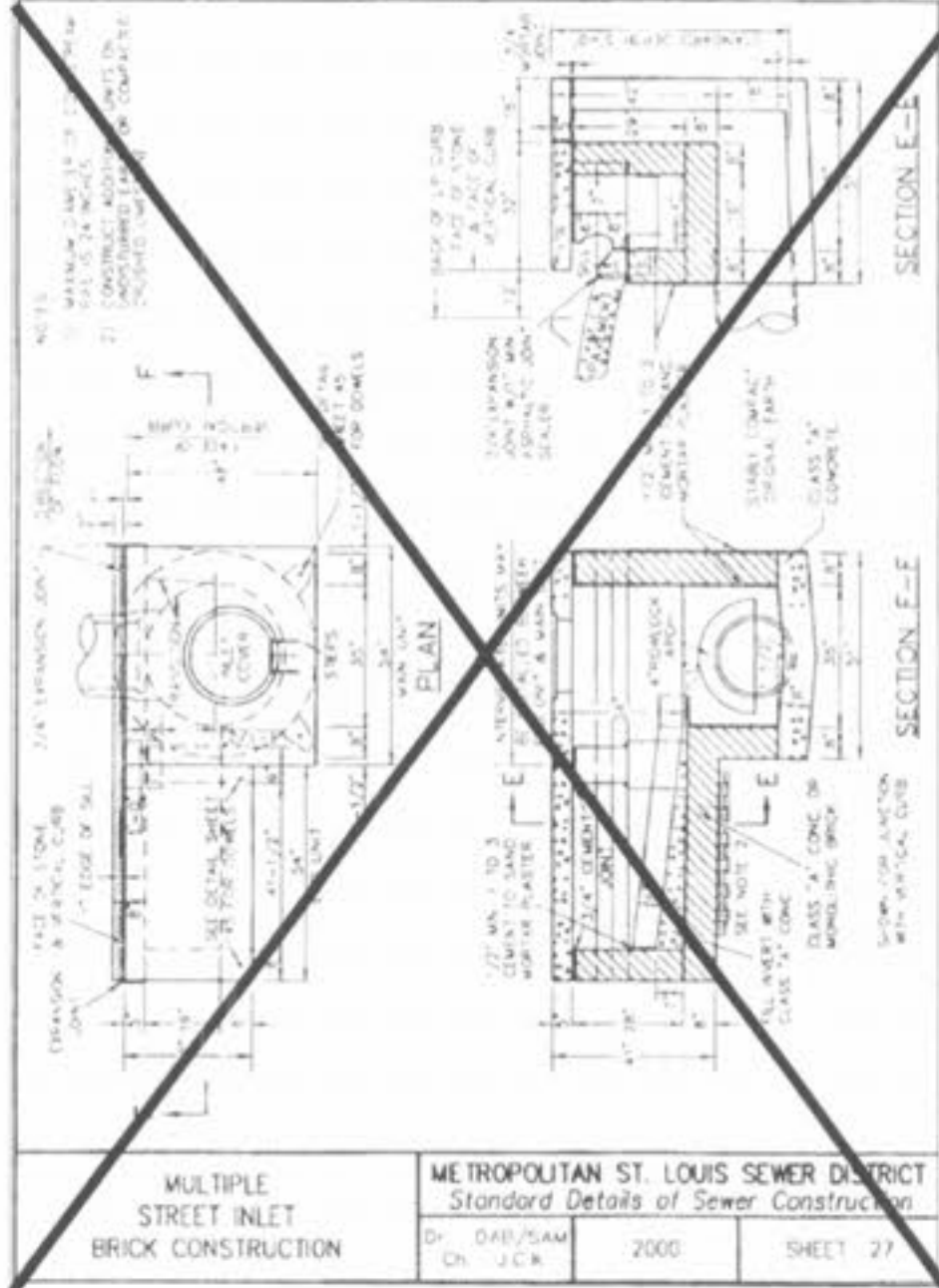

MULTIPLE STREET INLET BRICK CONSTRUCTION METROPOLITAN ST. LOUIS SEWER DISTRICT Standard Details of Sewer Construction SHEET 27

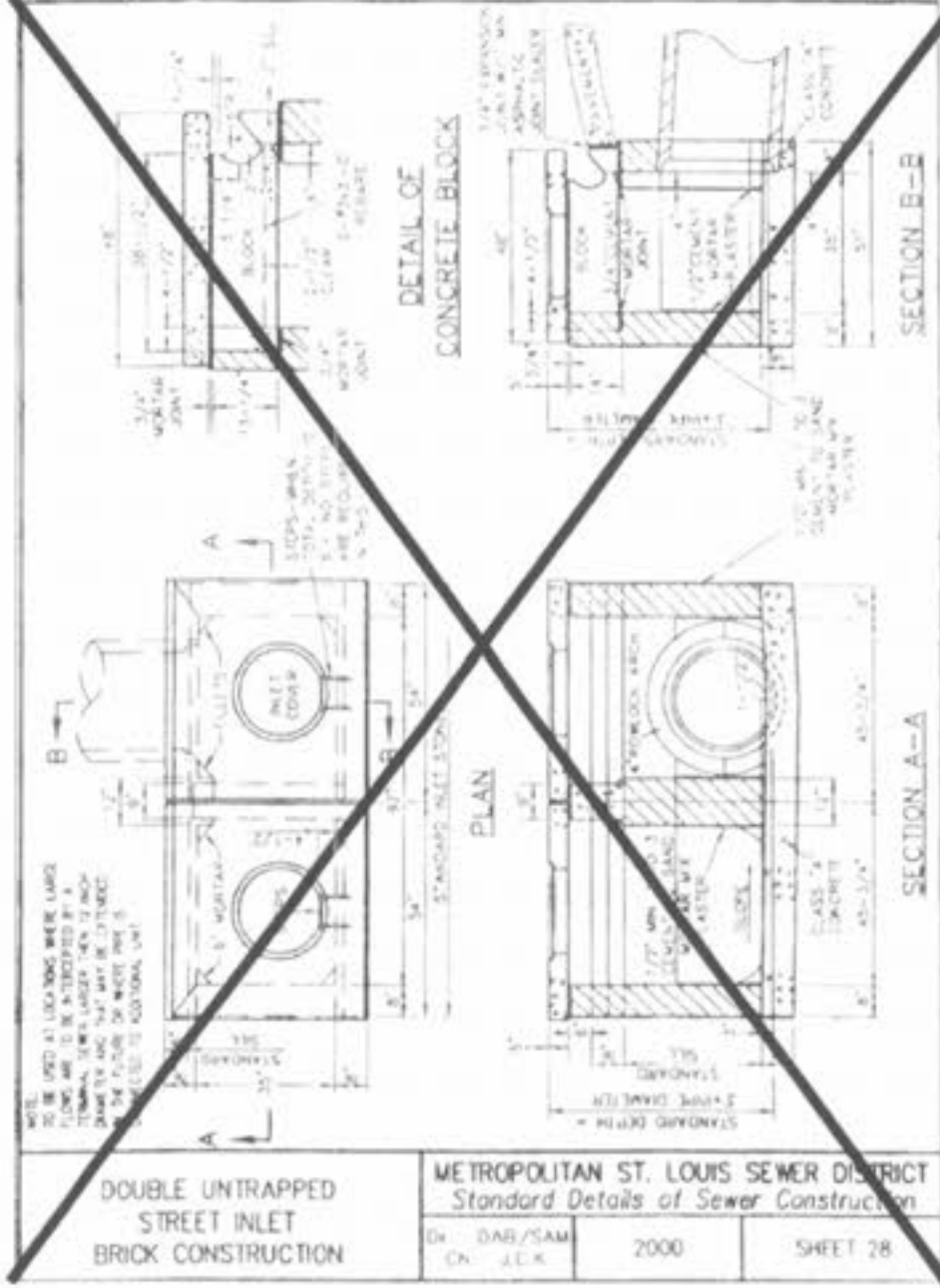

DOUBLE UNTRAPPED STREET INLET BRICK CONSTRUCTION METROPOLITAN ST. LOUIS SEWER DISTRICT Standard Details of Sewer Construction SHEET 28

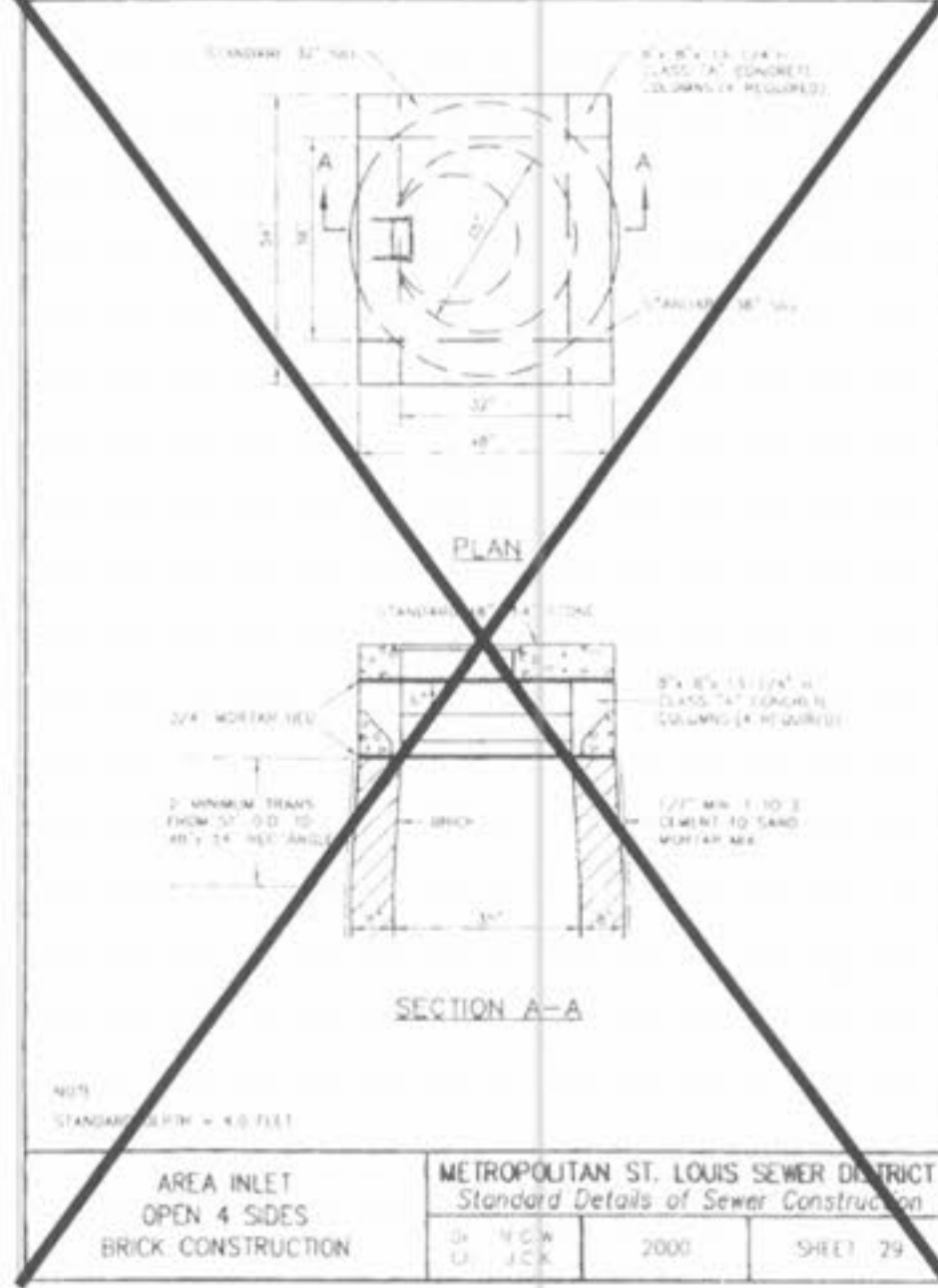

AREA INLET OPEN 4 SIDES BRICK CONSTRUCTION METROPOLITAN ST. LOUIS SEWER DISTRICT Standard Details of Sewer Construction SHEET 29

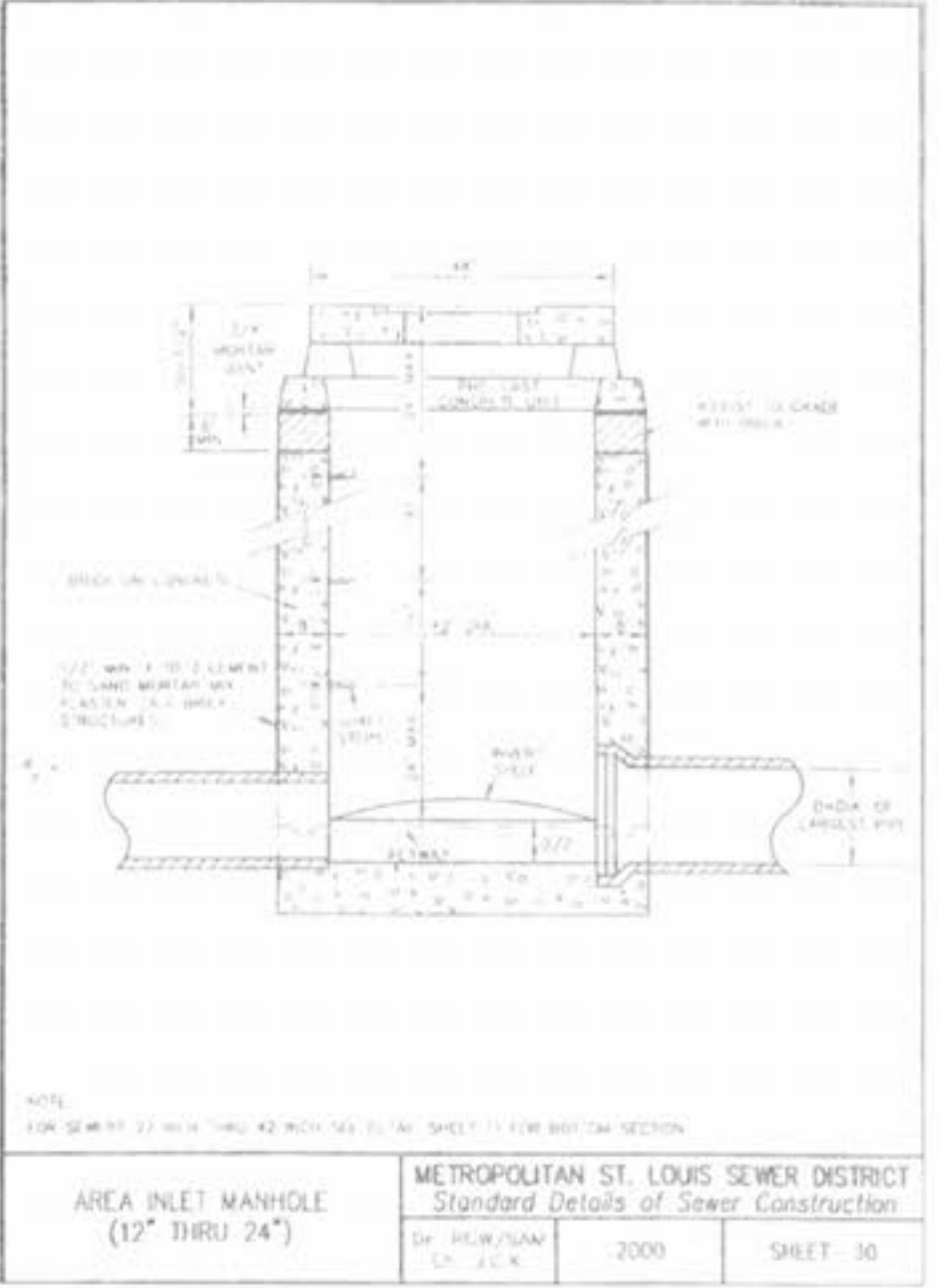

AREA INLET MANHOLE (12\"/>

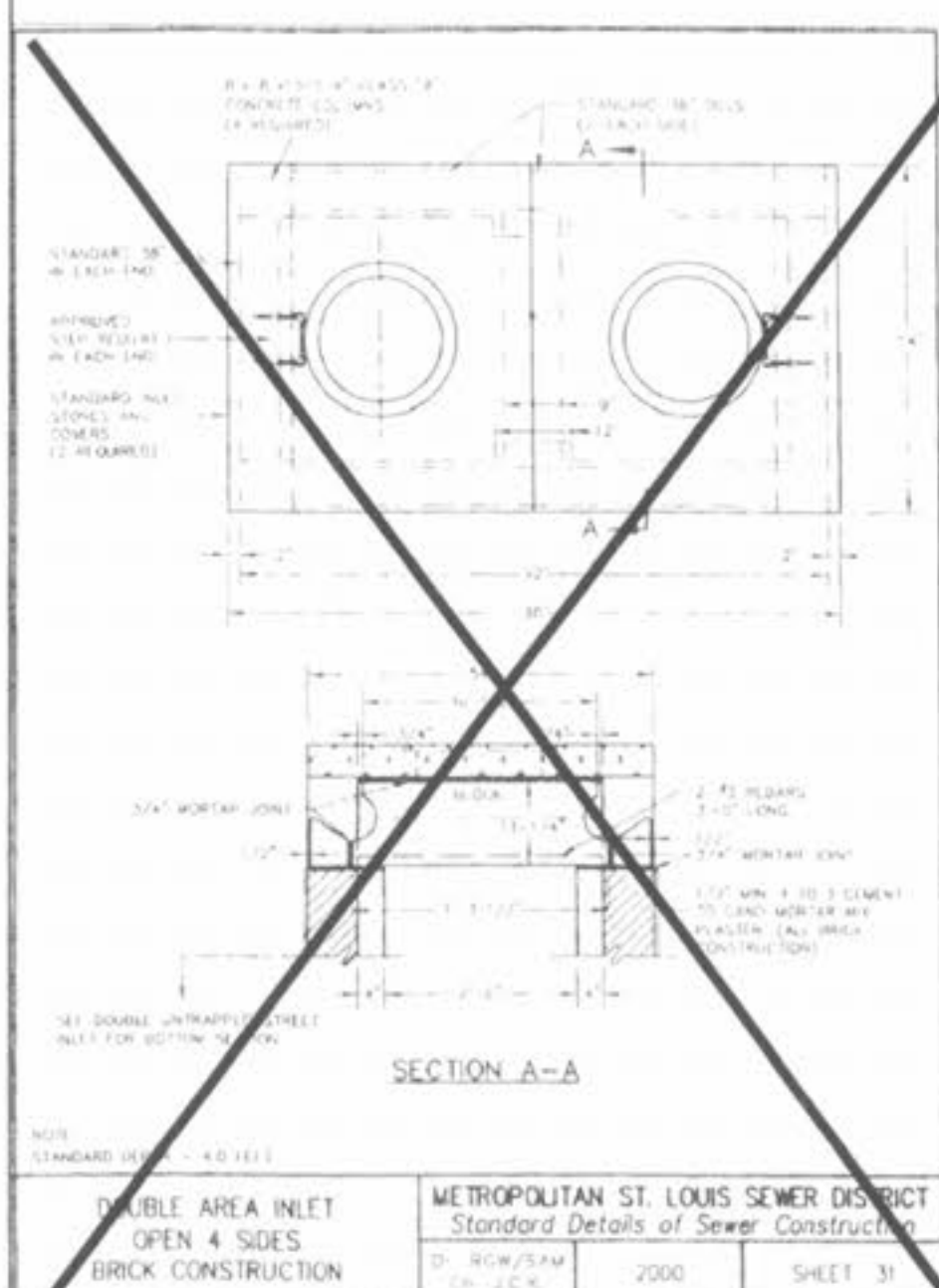

DOUBLE AREA INLET OPEN 4 SIDES BRICK CONSTRUCTION METROPOLITAN ST. LOUIS SEWER DISTRICT Standard Details of Sewer Construction SHEET 31

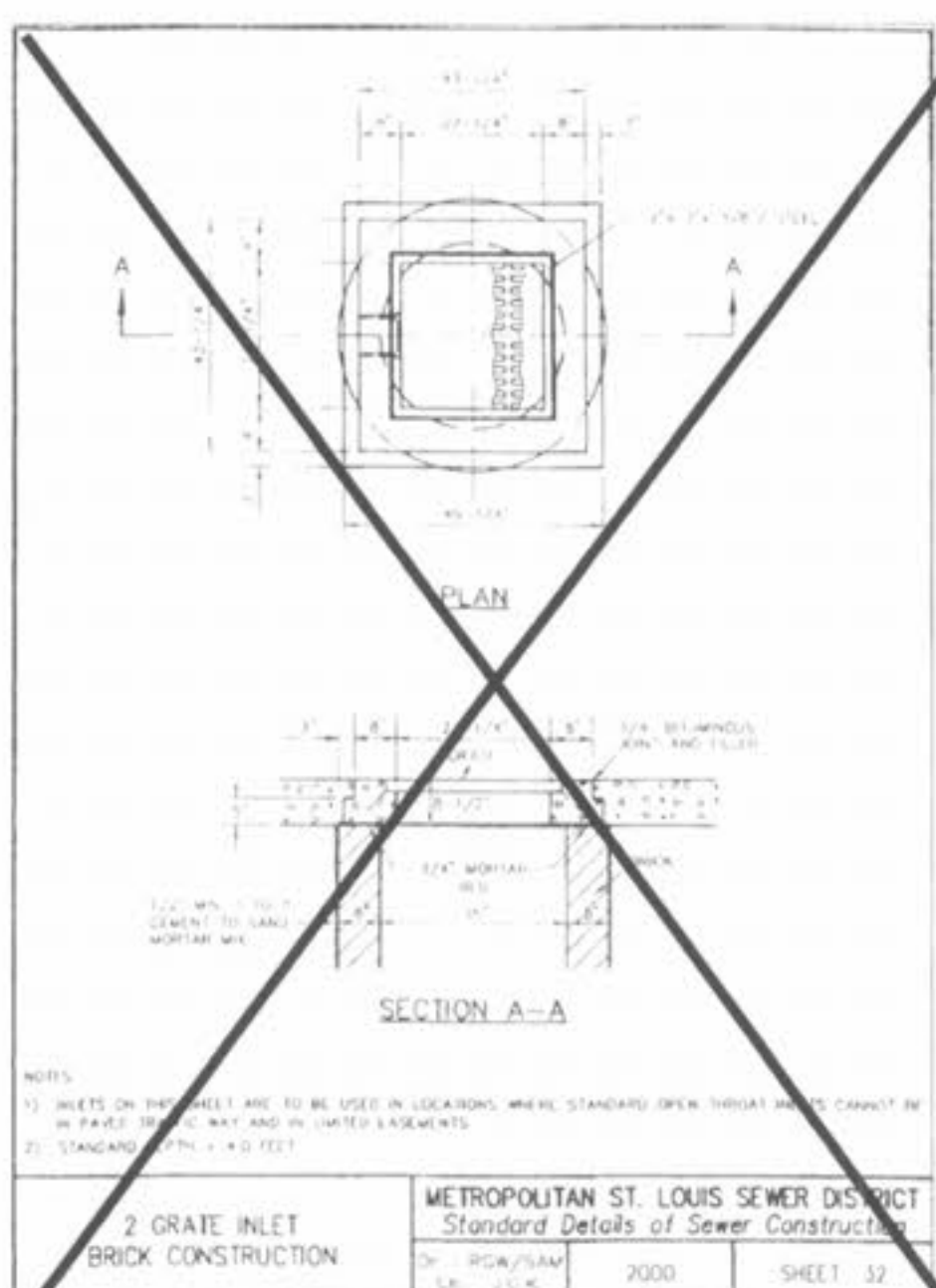

2 GRATE INLET BRICK CONSTRUCTION METROPOLITAN ST. LOUIS SEWER DISTRICT Standard Details of Sewer Construction SHEET 32

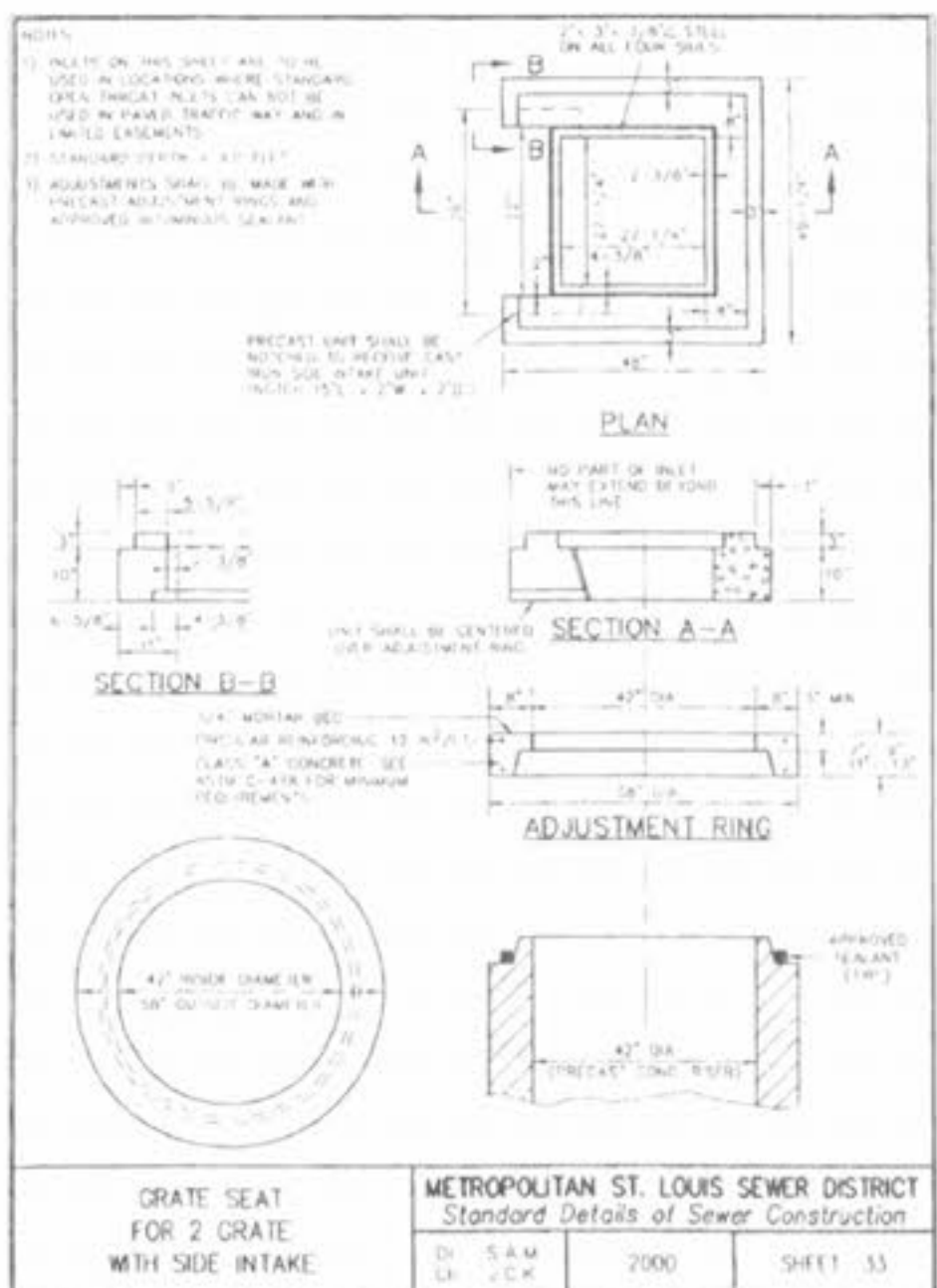

GRATE SEAT FOR 2 GRATES WITH SIDE INTAKE METROPOLITAN ST. LOUIS SEWER DISTRICT Standard Details of Sewer Construction SHEET 33

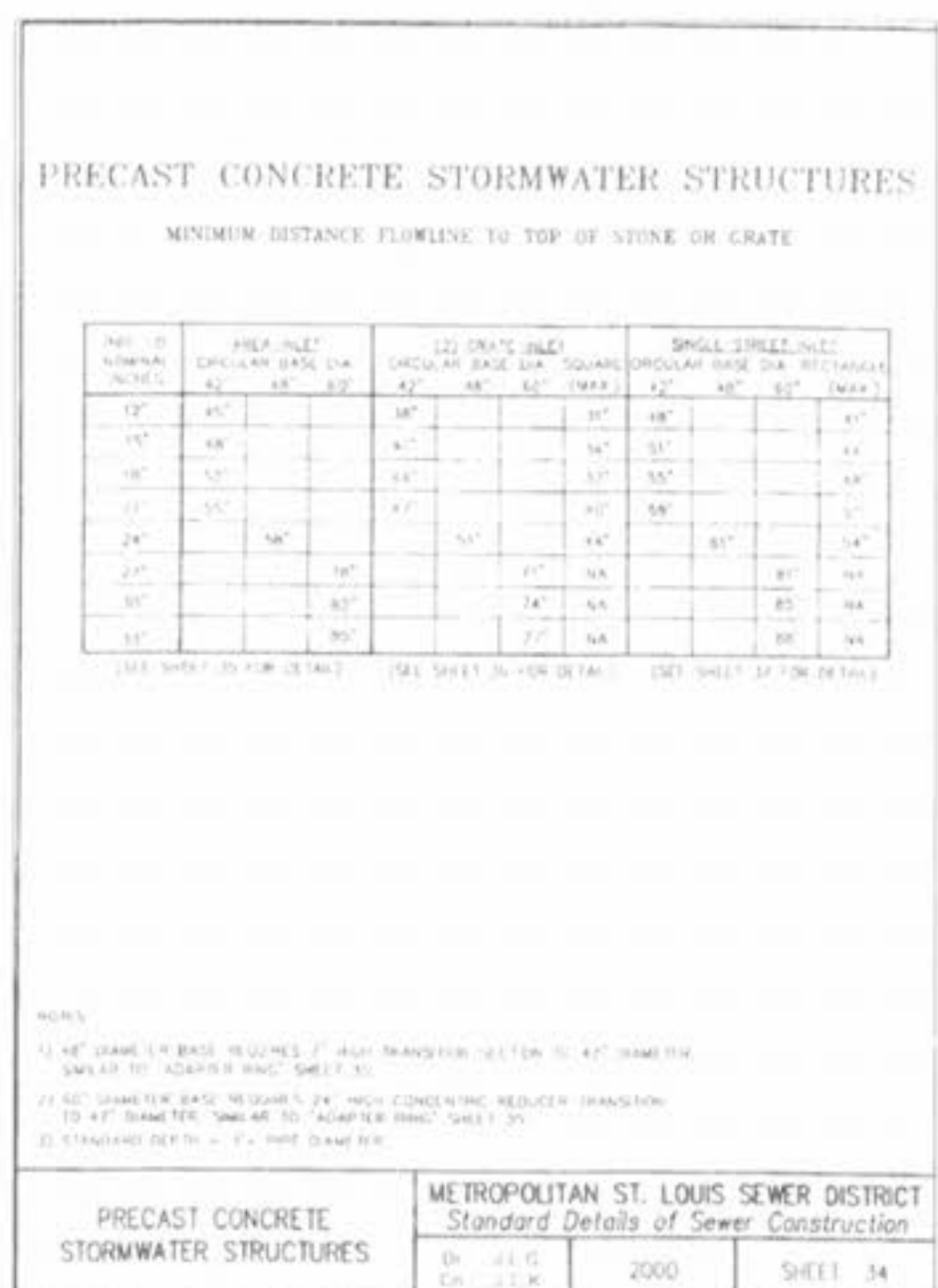

PRECAST CONCRETE STORMWATER STRUCTURES METROPOLITAN ST. LOUIS SEWER DISTRICT Standard Details of Sewer Construction SHEET 34

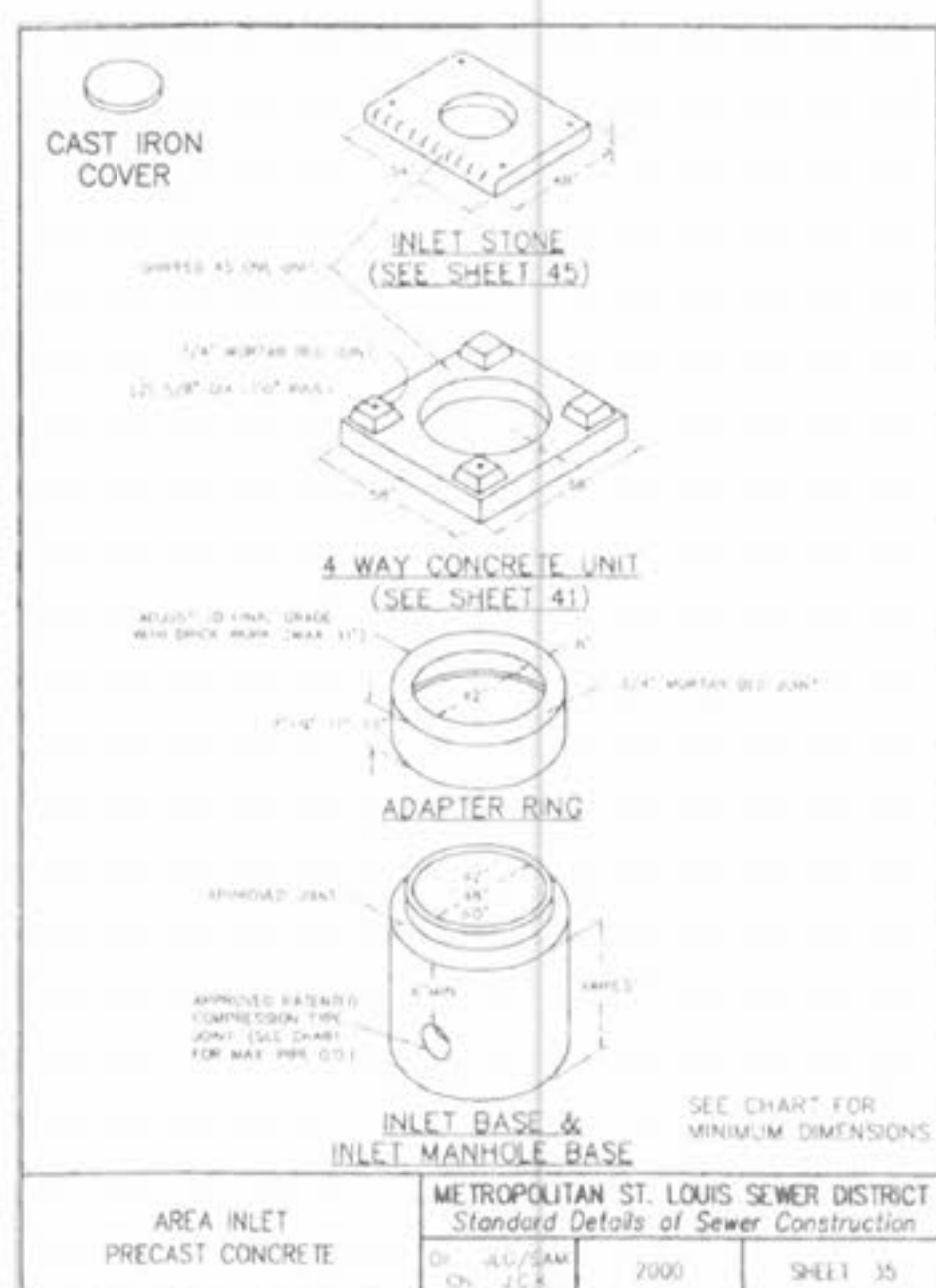

AREA INLET PRECAST CONCRETE METROPOLITAN ST. LOUIS SEWER DISTRICT Standard Details of Sewer Construction SHEET 35

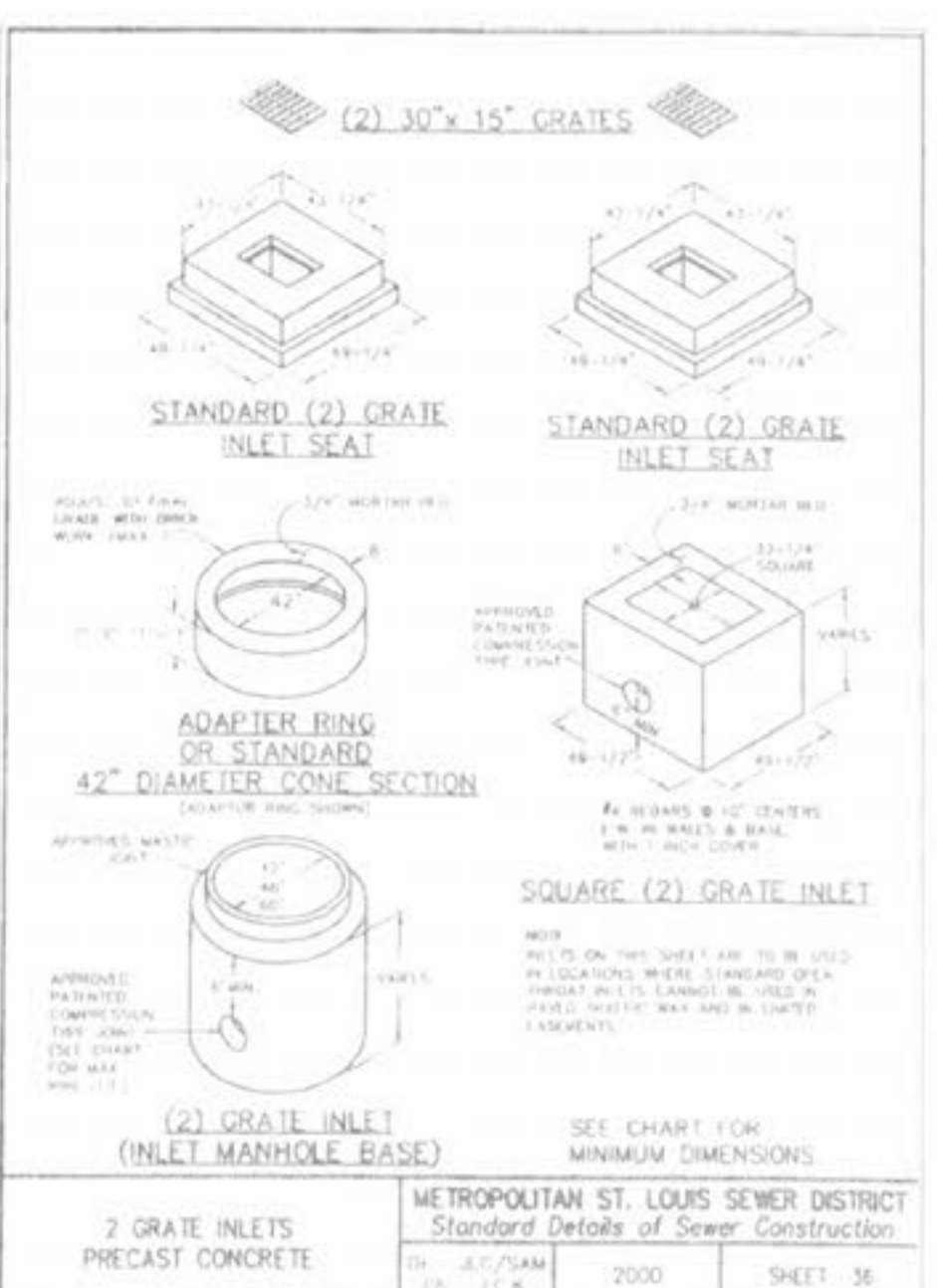

2 GRATE INLETS PRECAST CONCRETE METROPOLITAN ST. LOUIS SEWER DISTRICT Standard Details of Sewer Construction SHEET 36

ISSUE	REMARKS/DATE
1	03-01-04 FIRST SUBMITTAL
2	06-15-04 REVISED PER CITY COMMENTS
3	07-20-04 REVISED PER CITY COMMENTS
4	08-04-04 REVISED PER CITY COMMENTS
5	08-12-04 REVISED PER PWS&Z COMMENTS

PREPARED FOR:
McBride & Son Homes
 Land Development, Inc.
 #1 McBride & Son Center Drive
 Chesterfield, Missouri 63005
 (636) 537-2000



PREPARED BY:
THE STERLING CO.
 ENGINEERS & SURVEYORS
 5055 NEW BAUMGARTNER ROAD
 ST. LOUIS, MISSOURI 63129
 (314) 487-0440 FAX 487-8844
 E-Mail: Sterling@sterling-eng-sur.com

PROJECT:	NO. 03 06 147
DRAWN:	M.S.D. SHEET
DESIGNED:	CD4
CHECKED:	MSD CONSTRUCTION DETAILS
SHEET TITLE:	MSD CONSTRUCTION DETAILS