

Drawing name: K:\D\0306147 Fox Haven\IMPROVEMENTS\6147DETAILS.dwg Plotted on: Aug 24, 2005 - 8:31am Plotted by: Juetkenhaus

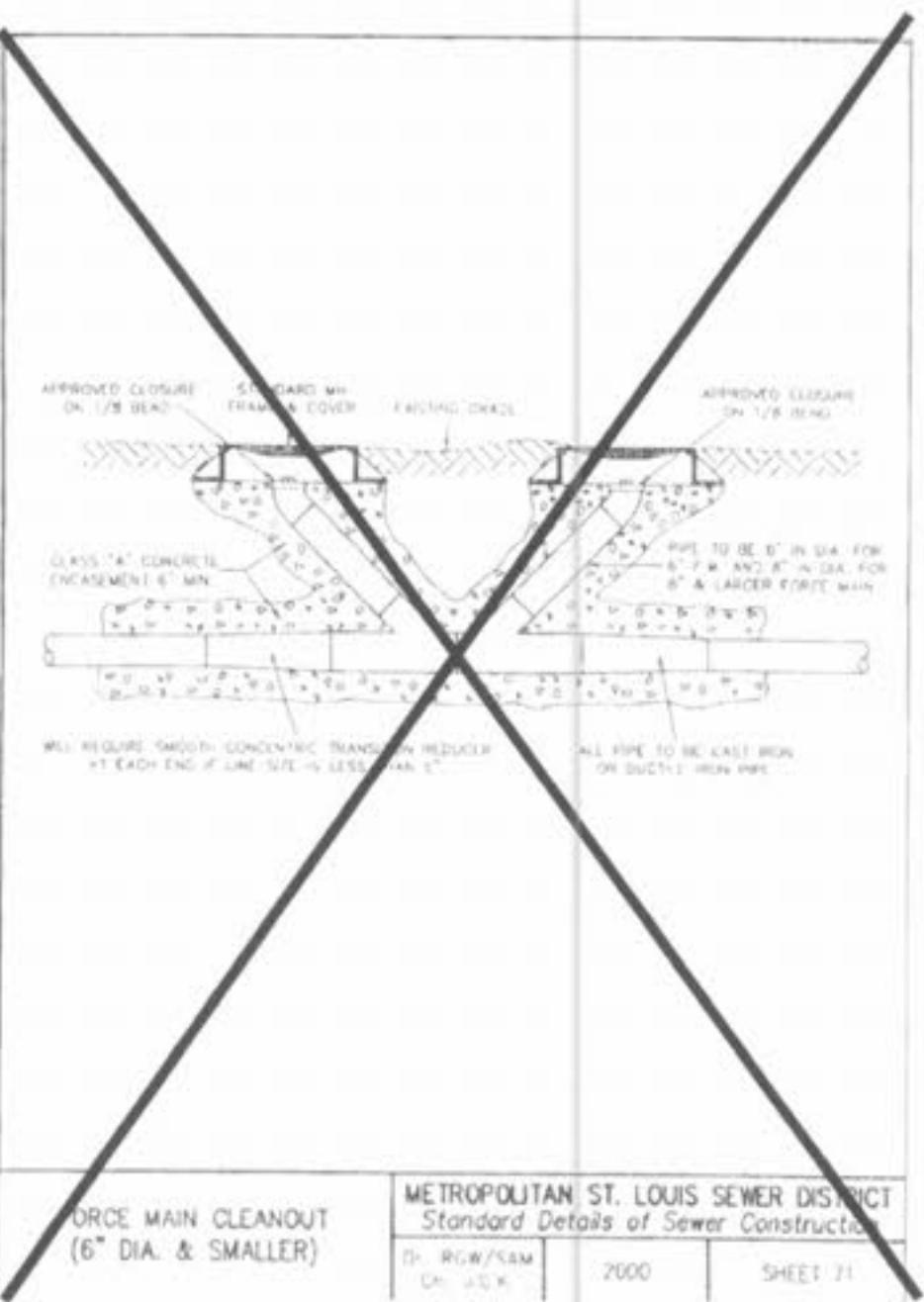

ISSUE	REMARKS/DATE
1	03-01-04 FIRST SUBMITTAL
2	06-15-04 REVISED PER CITY & DCSD COMMENTS
3	07-20-04 REVISED PER CITY COMMENTS
4	08-04-04 REVISED PER CITY COMMENTS
5	08-12-04 REVISED PER PWS&P COMMENTS

PREPARED FOR:
**McBride & Son Homes
Land Development, Inc.**
#1 McBride & Son Center Drive
Chesterfield, Missouri 63005
(636) 537-2000

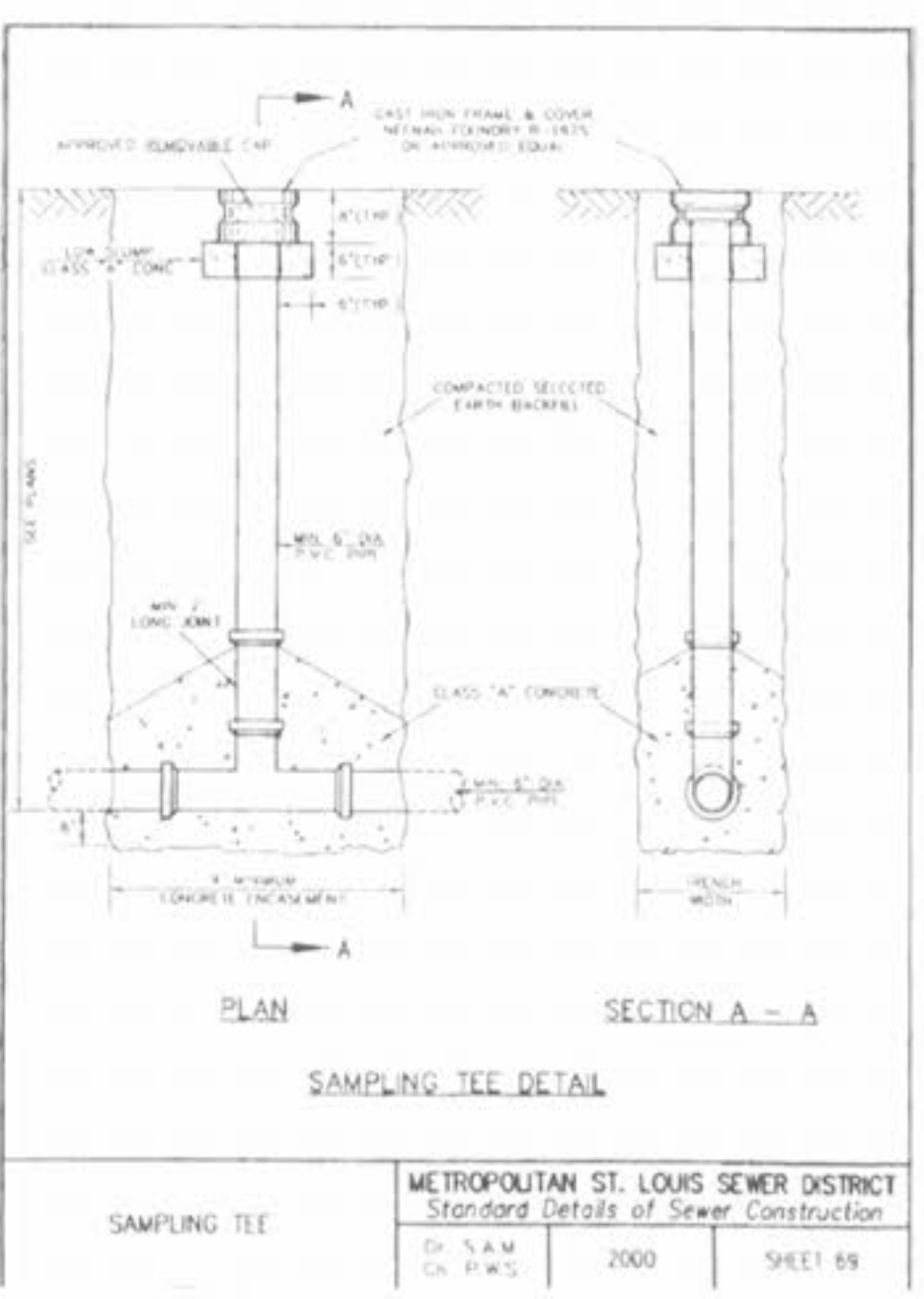
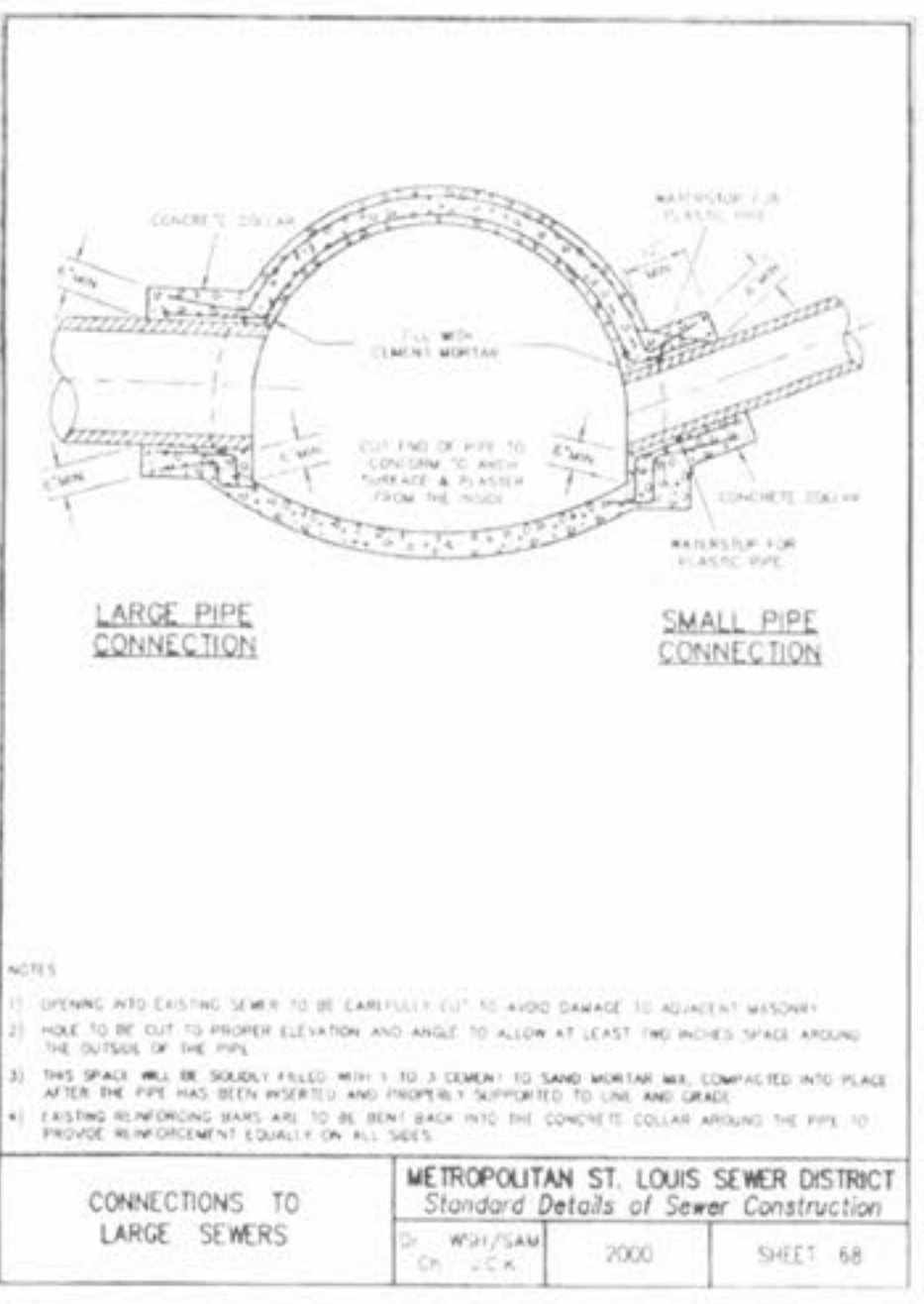
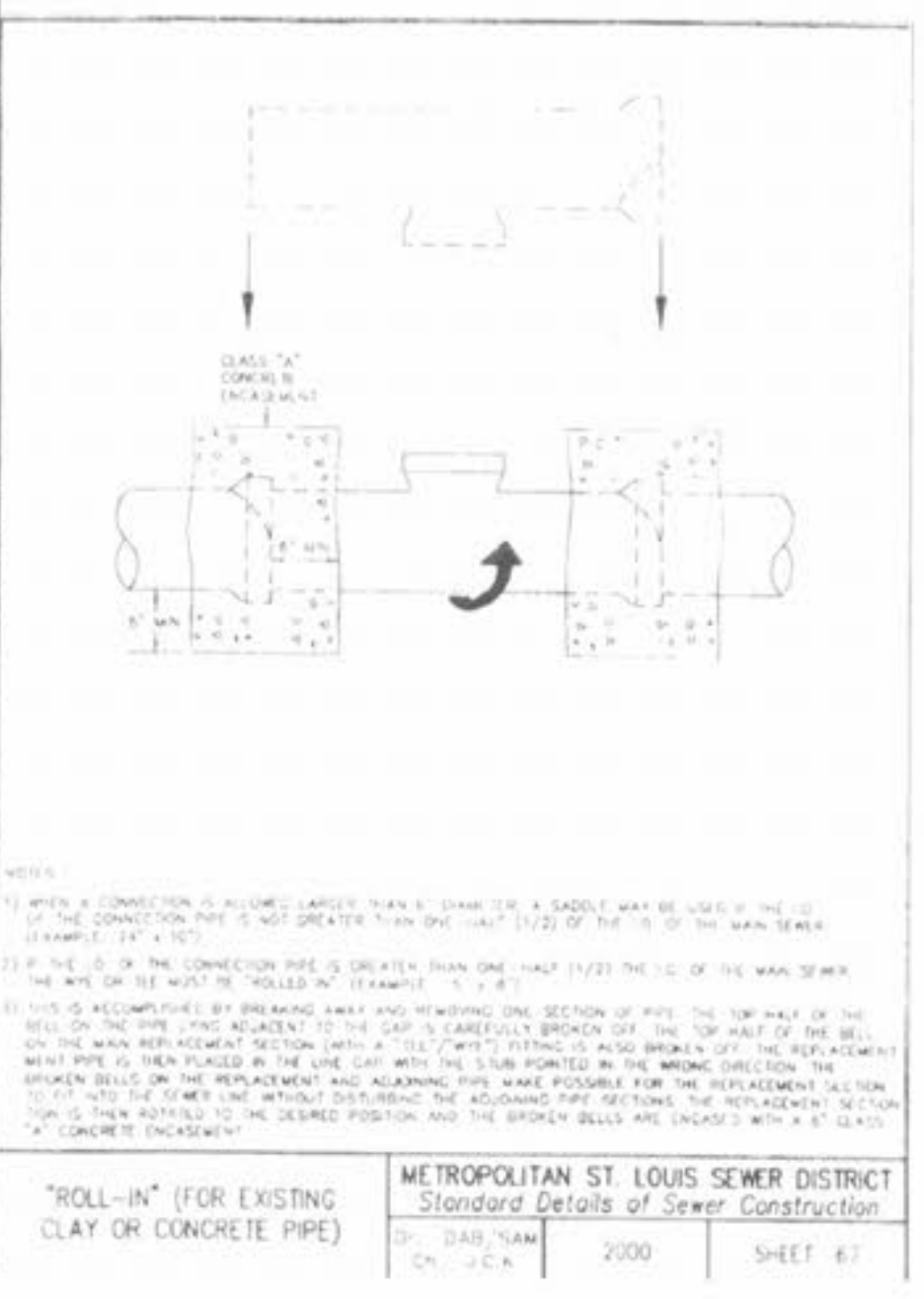
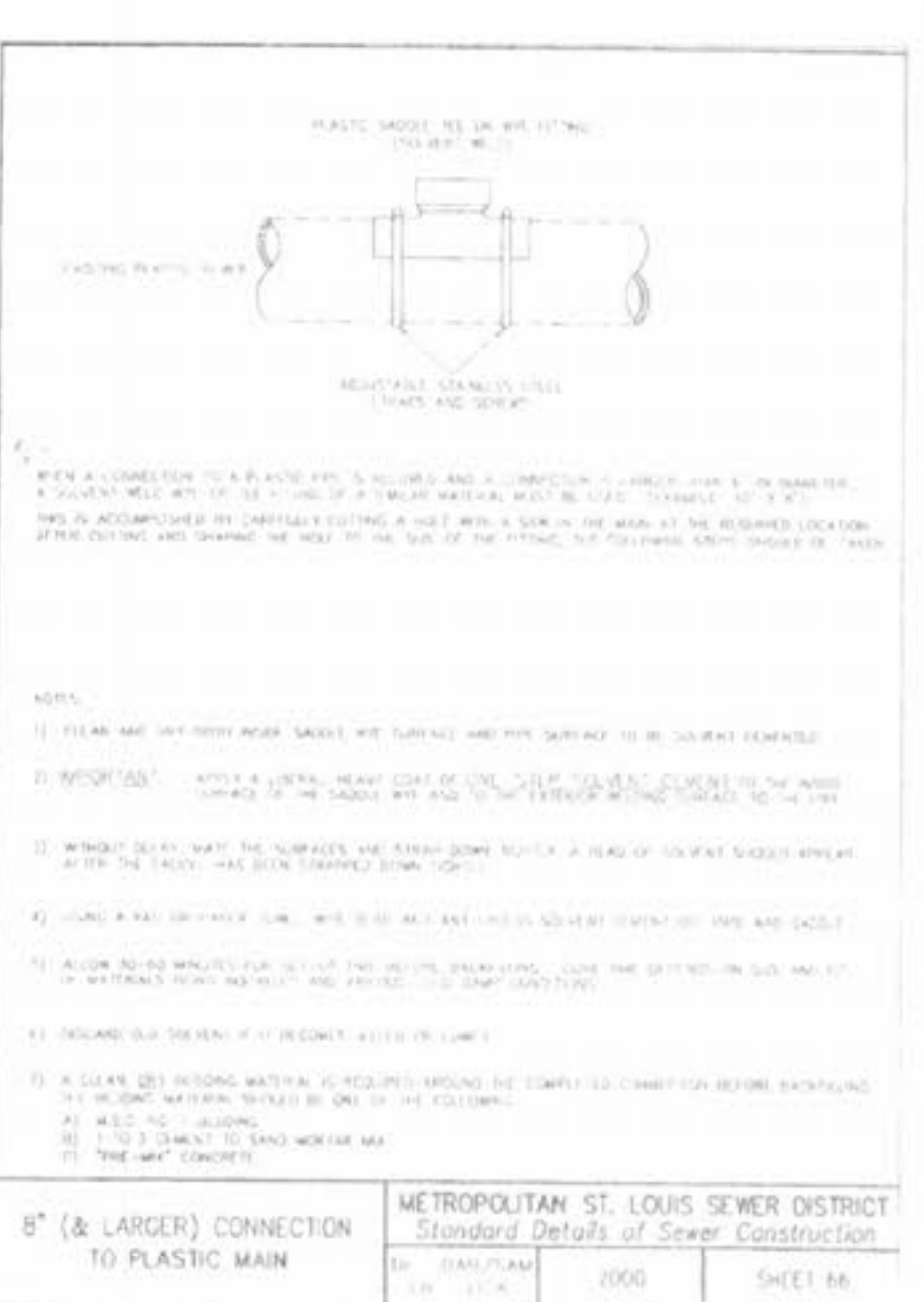
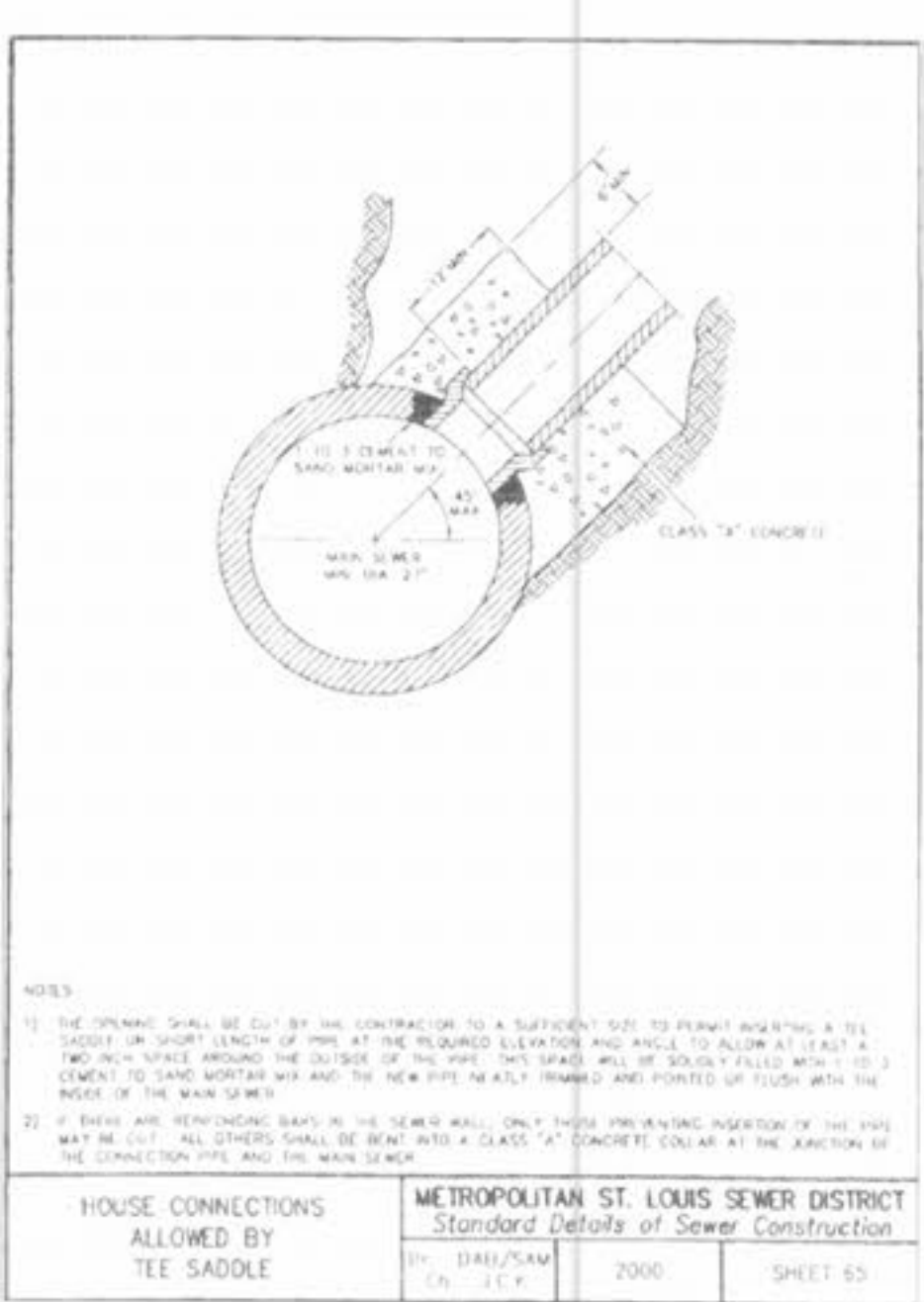
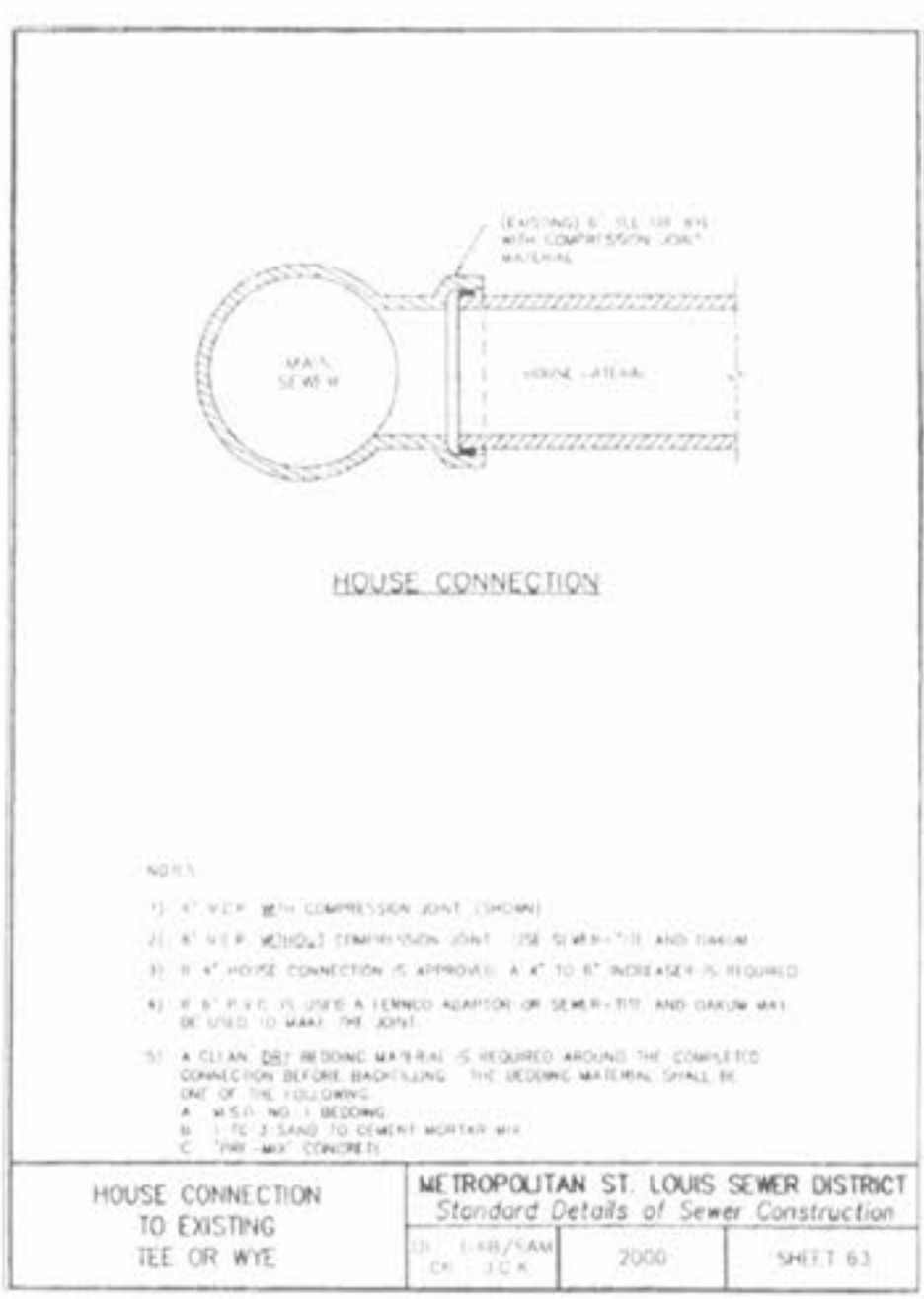
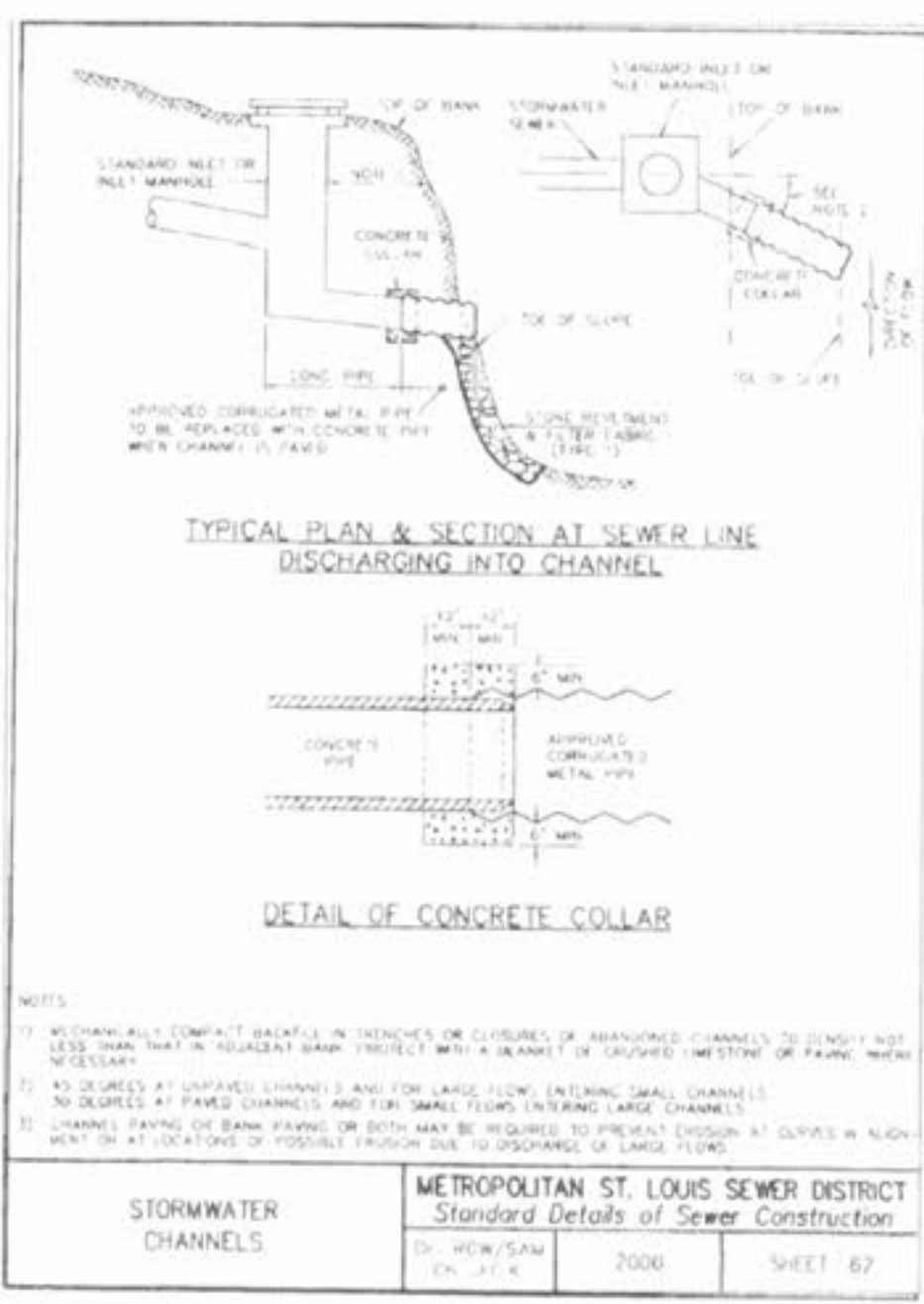
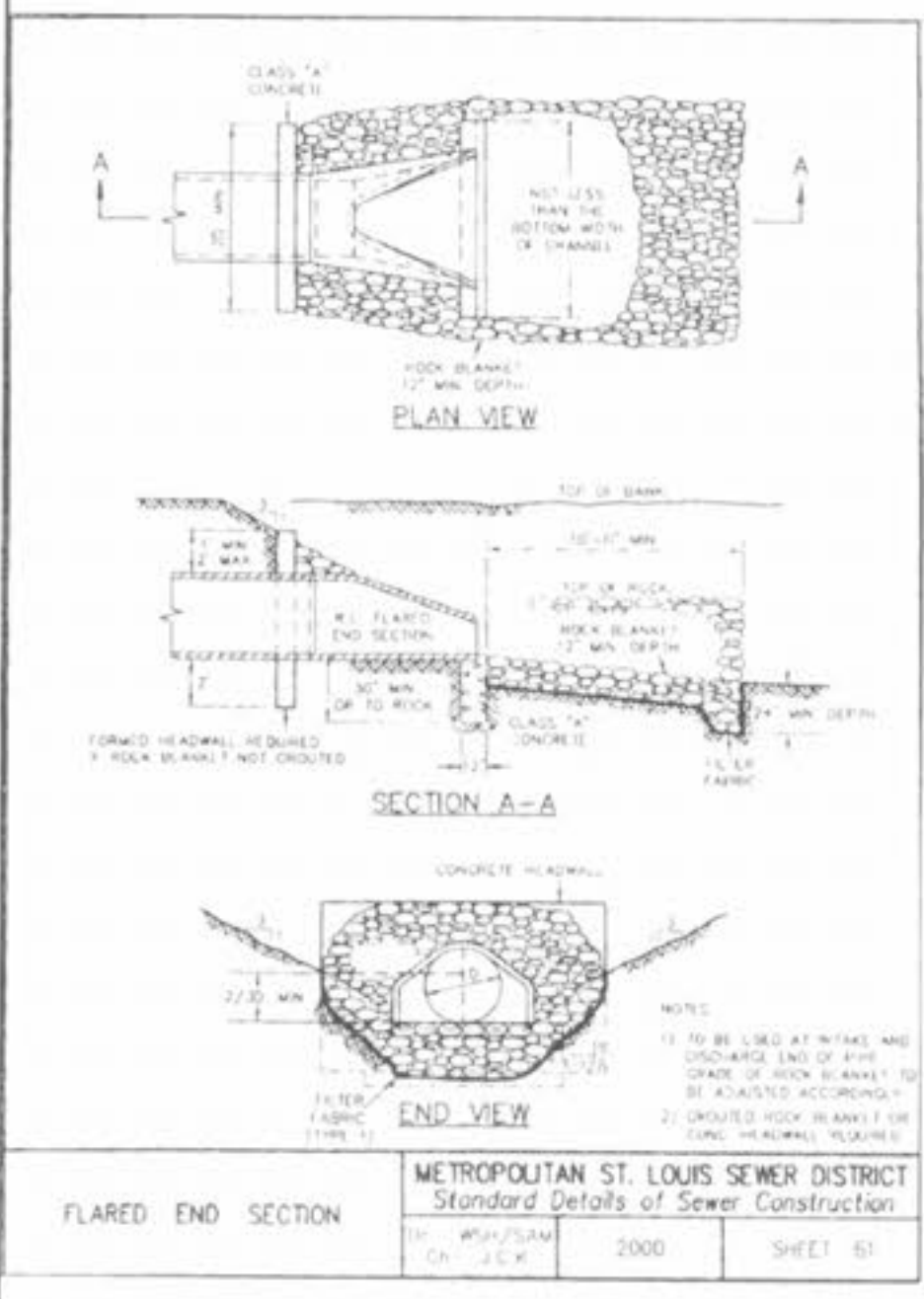
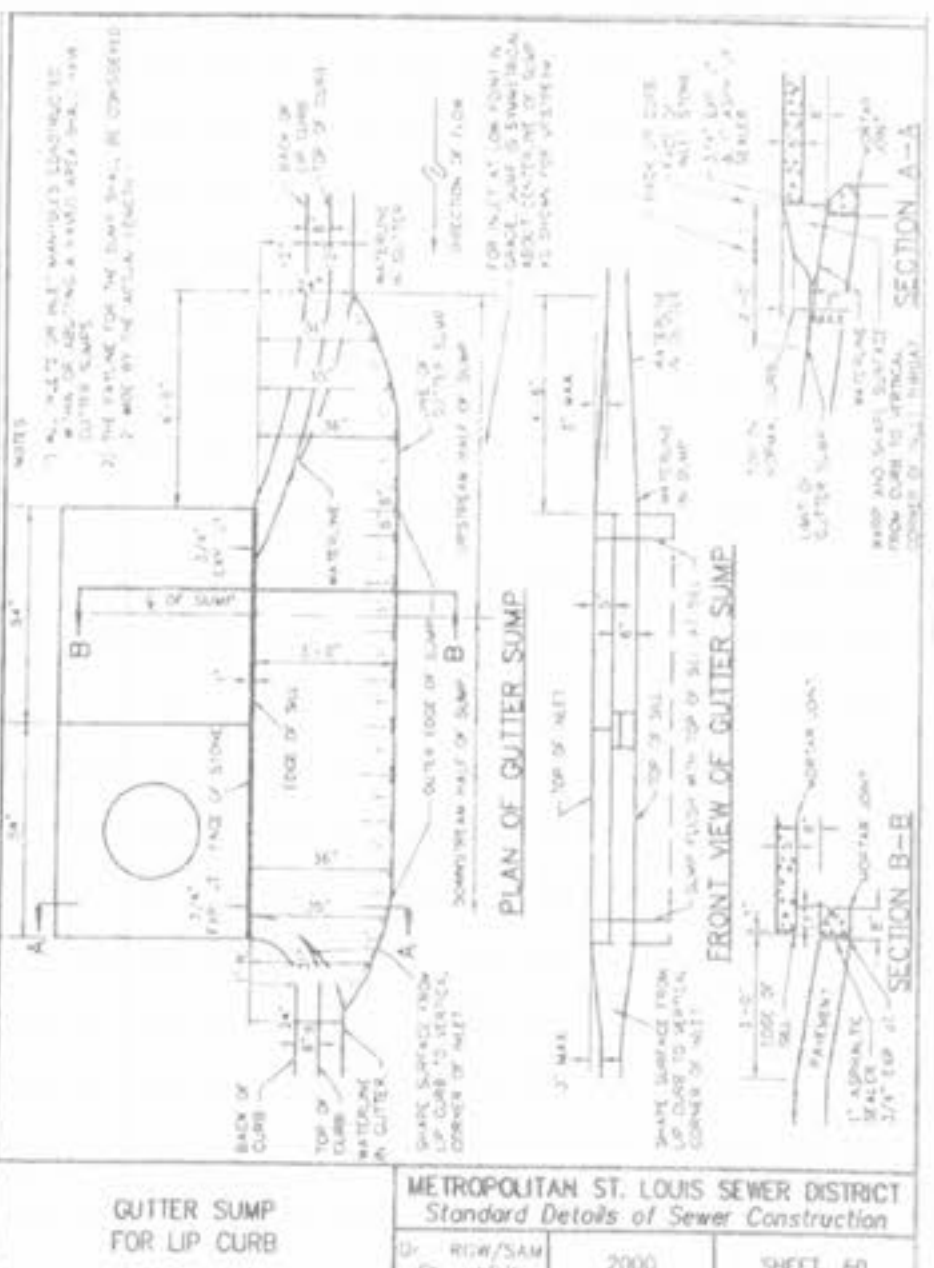
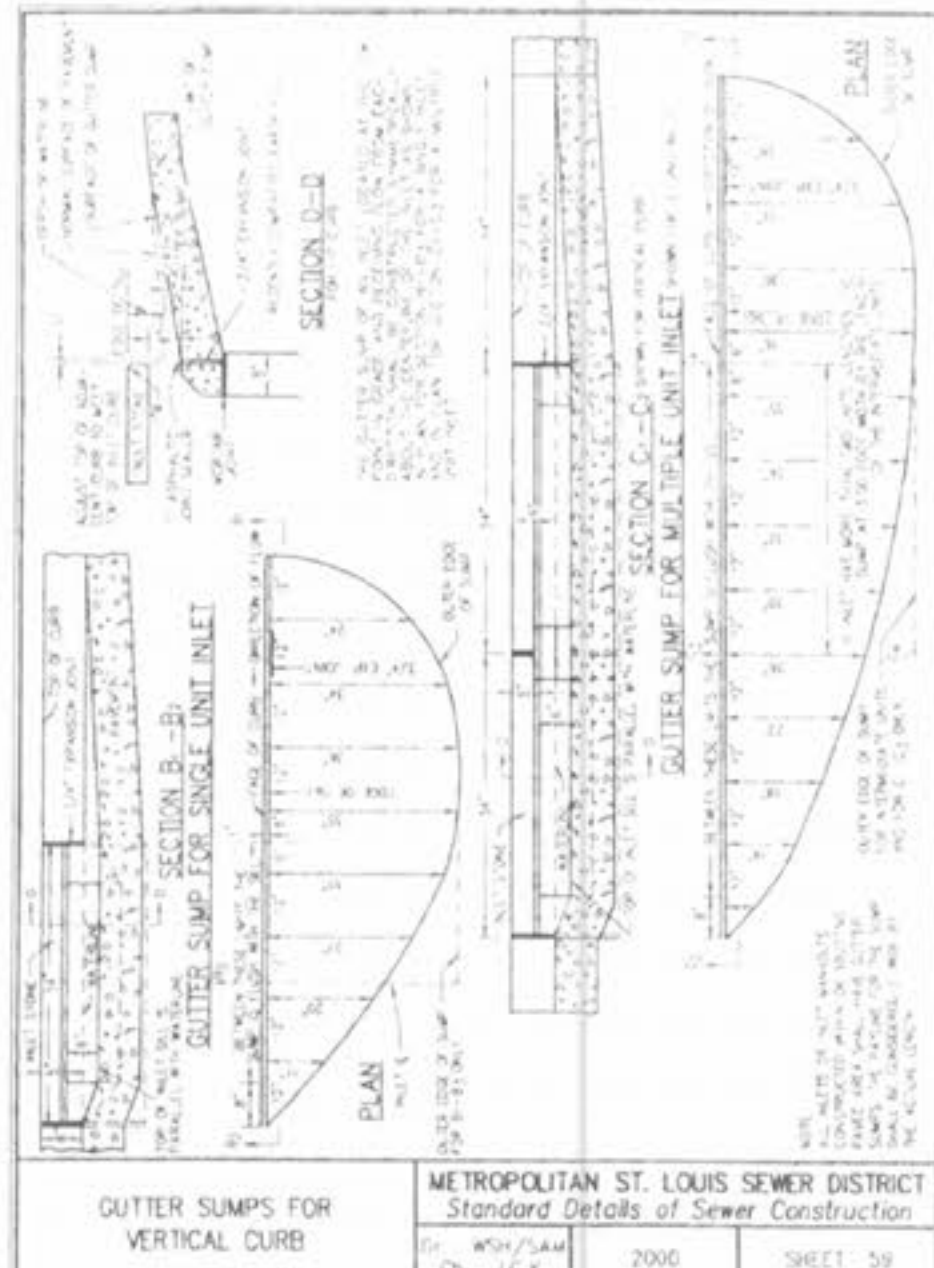
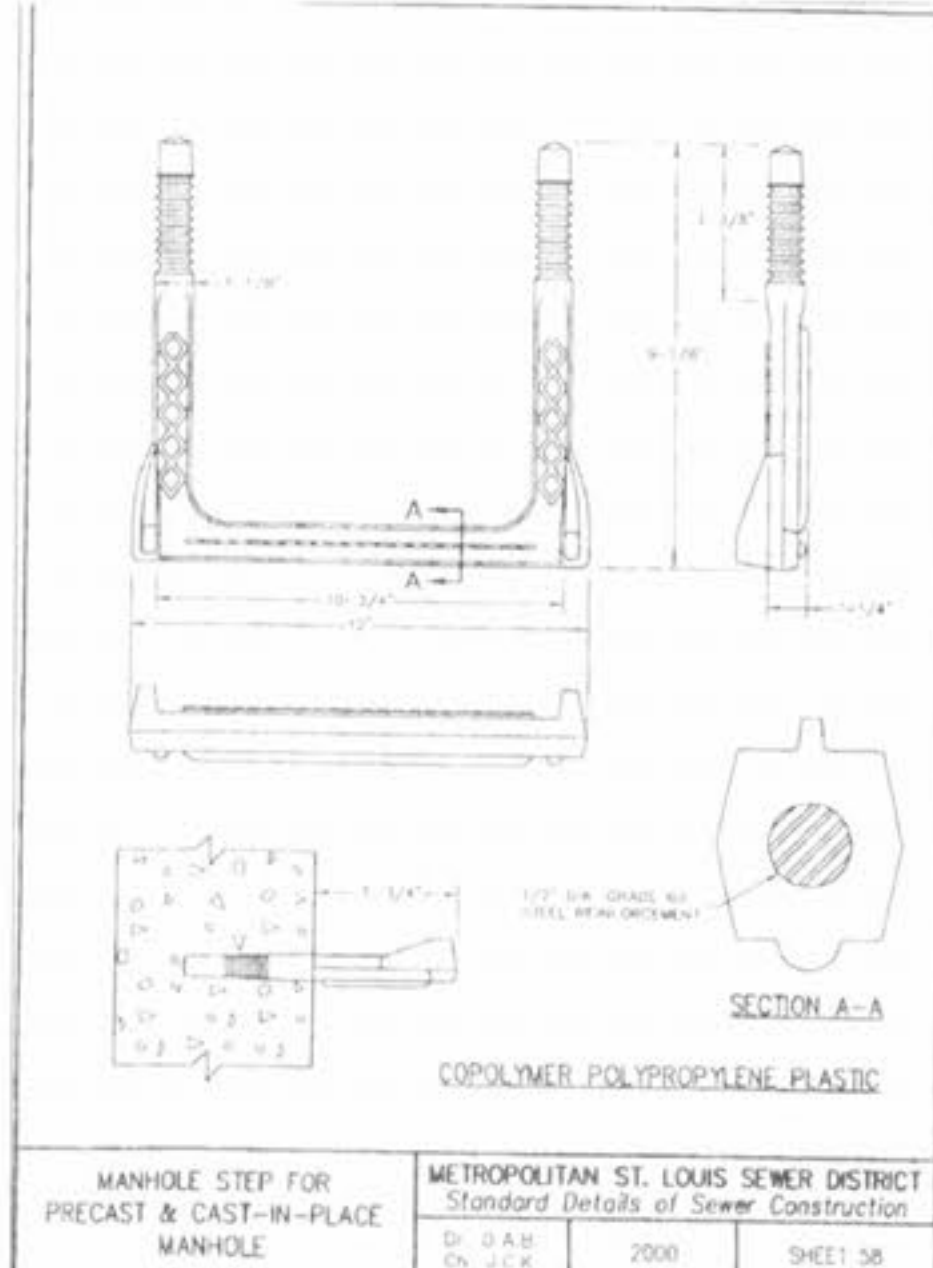
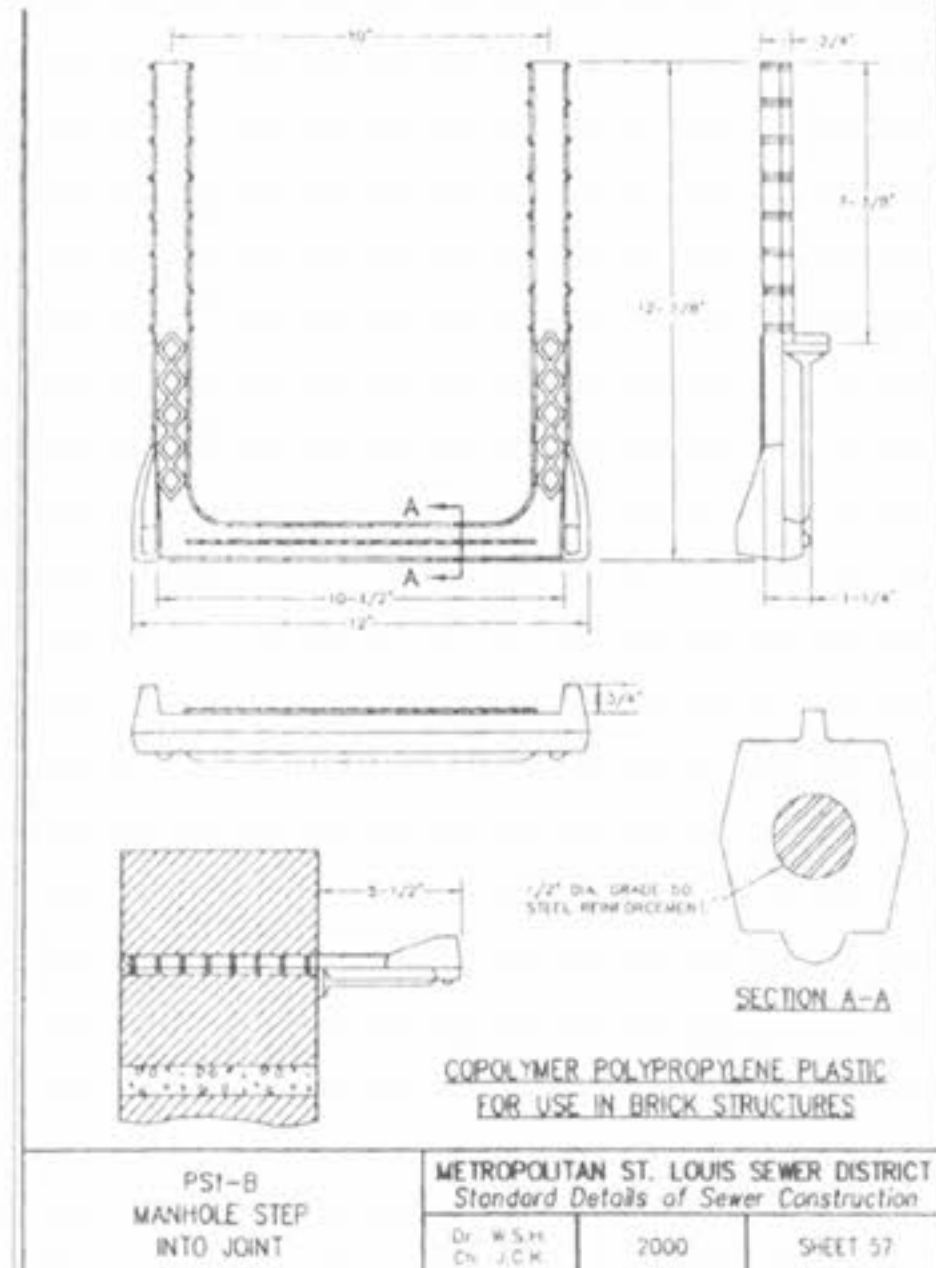
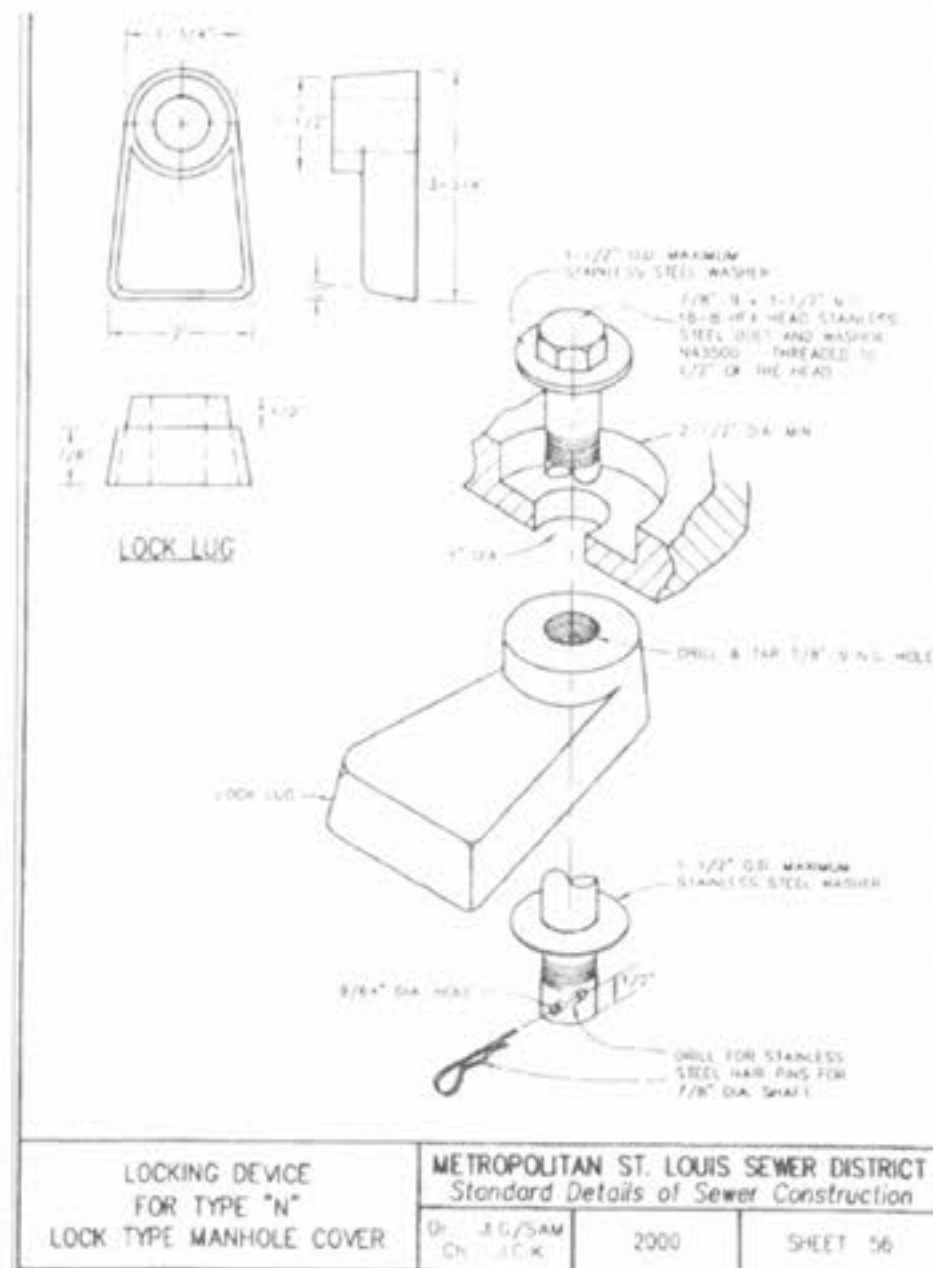
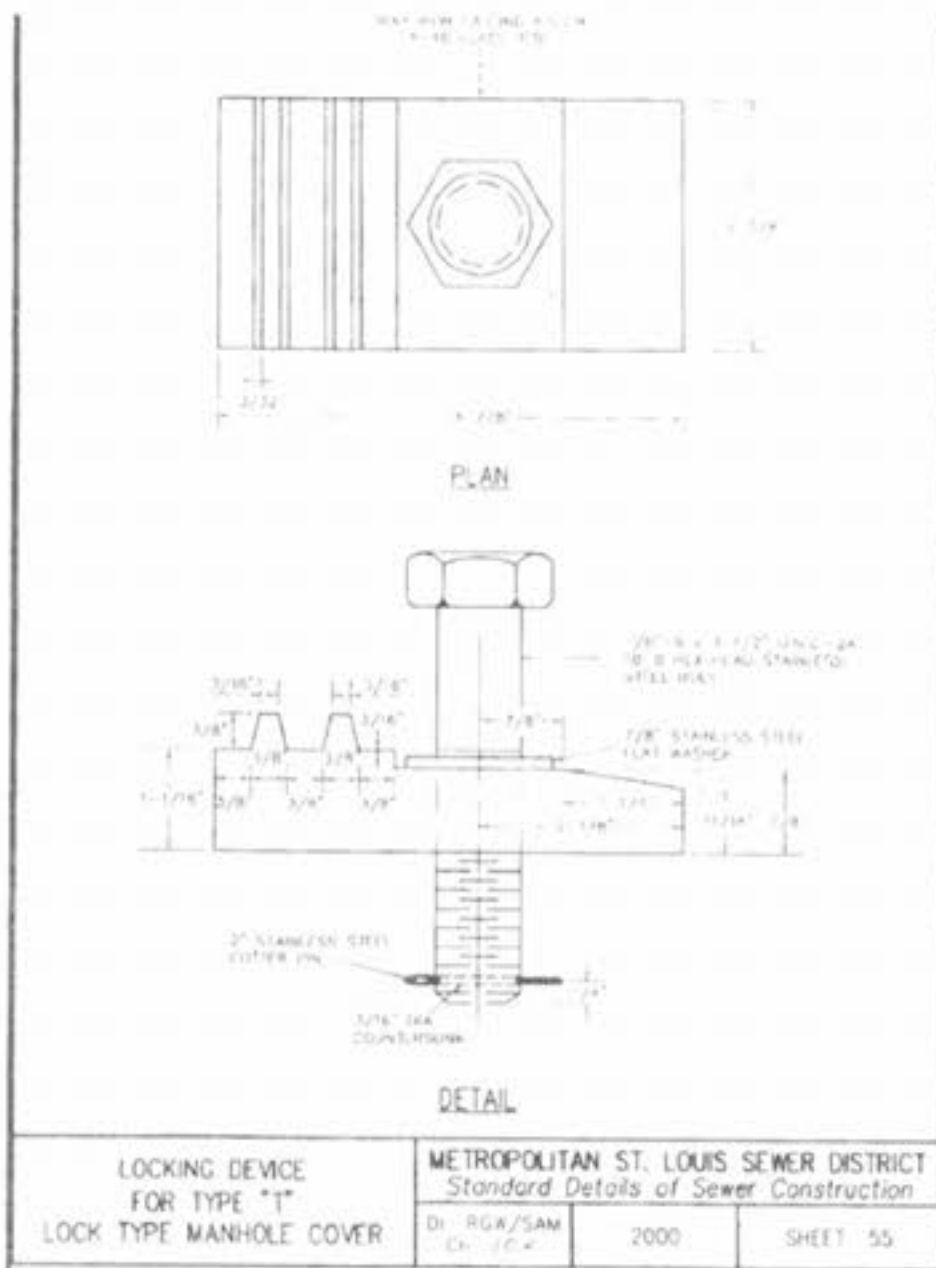

PREPARED BY:
THE STERLING CO.
ENGINEERS & SURVEYORS
5055 NEW BRUNSWICK BOULEVARD
ST. LOUIS, MISSOURI 63112
(314) 487-0440 FAX: 487-8844
E-Mail: Sterling@sterling-eng-sur.com

DRAWN:	DESIGNED:	CHECKED:
PROJECT:	NO. 03 06 147	M.S.D. SHEET
PROJECT:	FOX HAVEN	P# CD6
SHEET TITLE:	MSD CONSTRUCTION DETAILS	DIGITAL FILE LOCATION: SEWER-STERLING-2