

SUNVIEW DRIVE ENTRANCE DETAIL
 SCALE: 1"=10'

- ALL SPOTS ARE TO TOP OF PAVEMENT UNLESS OTHERWISE NOTED
- ALL ROADWAYS SHALL BE KEPT CLEAR OF MUD AND DEBRIS AT ALL TIMES
- ALL PAVEMENT REMOVAL IS TO BE TO NEAREST JOINT
- ALL TRAFFIC CONTROL TO BE PER MUTCD.

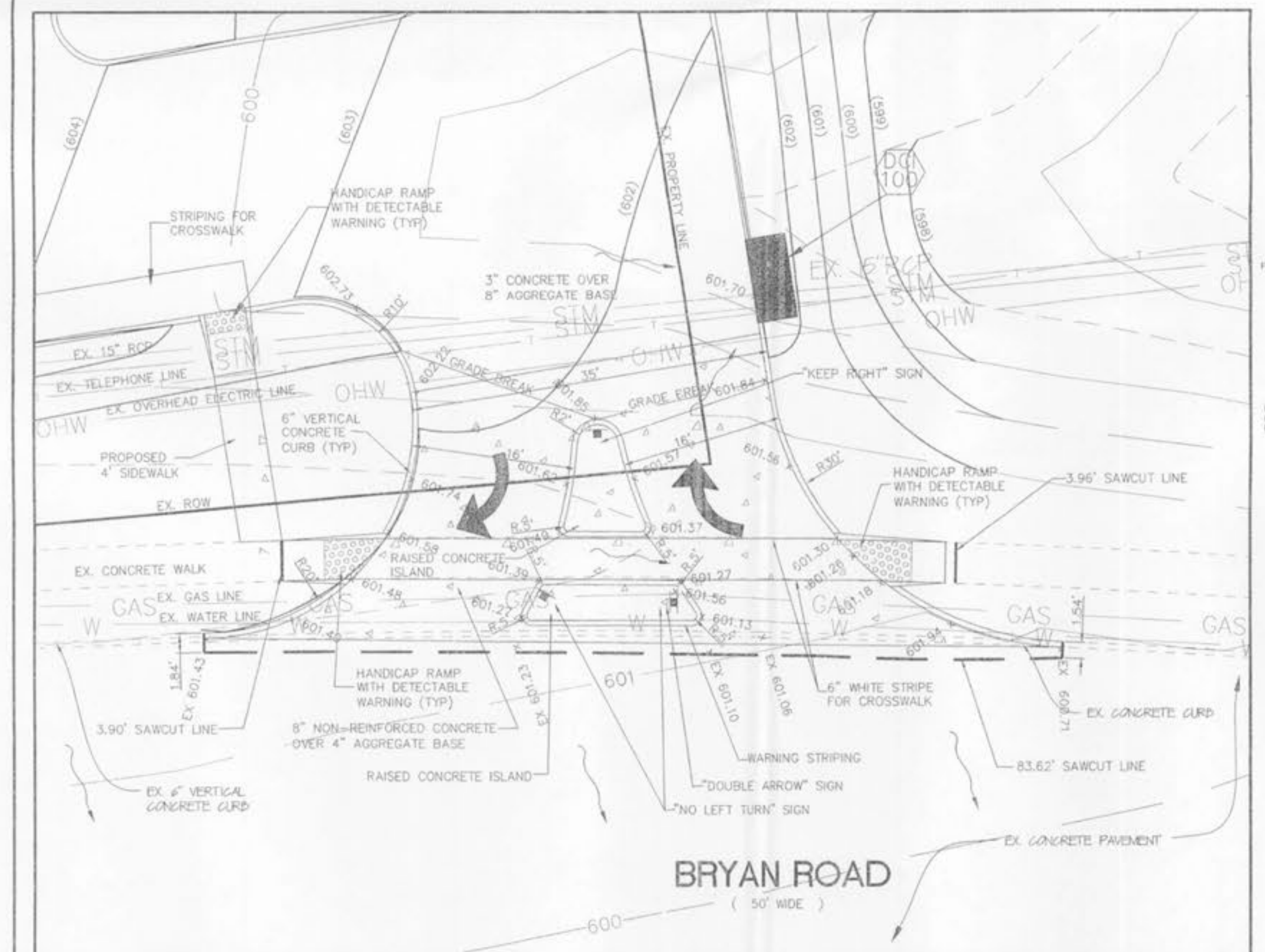

BRYAN ROAD ENTRANCE DETAIL
 SCALE: 1"=10'

- ALL SPOTS ARE TO TOP OF PAVEMENT UNLESS OTHERWISE NOTED
- ALL ROADWAYS SHALL BE KEPT CLEAR OF MUD AND DEBRIS AT ALL TIMES
- ALL PAVEMENT REMOVAL IS TO BE TO NEAREST JOINT
- ALL TRAFFIC CONTROL TO BE PER MUTCD.

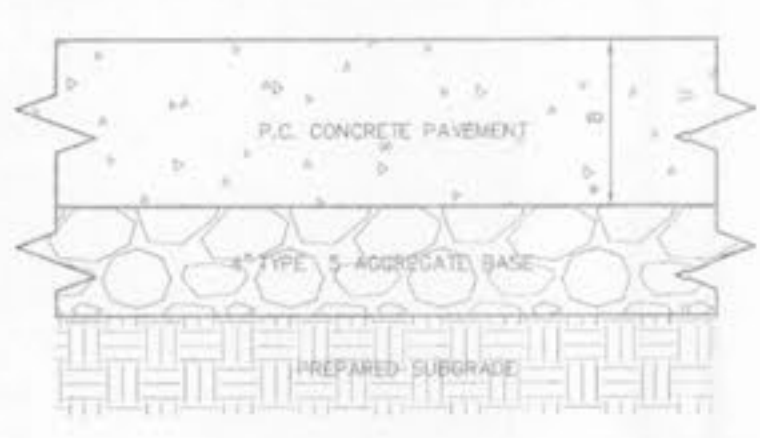

ENTRANCE PAVEMENT DETAIL
 NOT TO SCALE

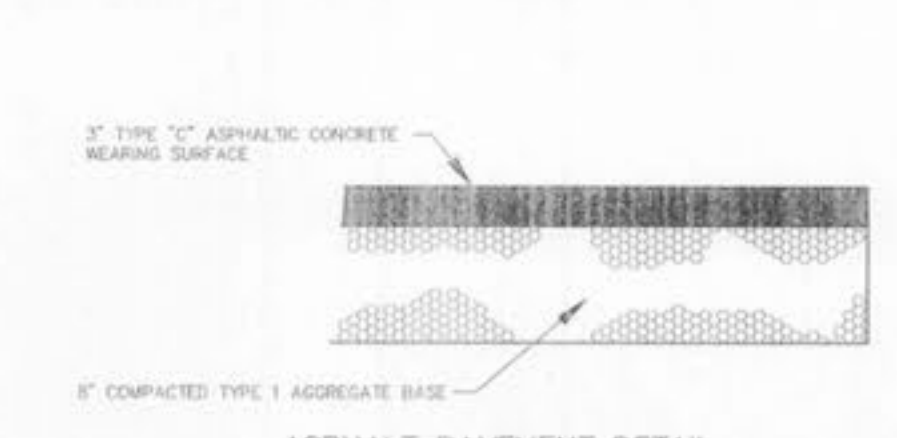

ASPHALT PAVEMENT DETAIL
 NOT TO SCALE

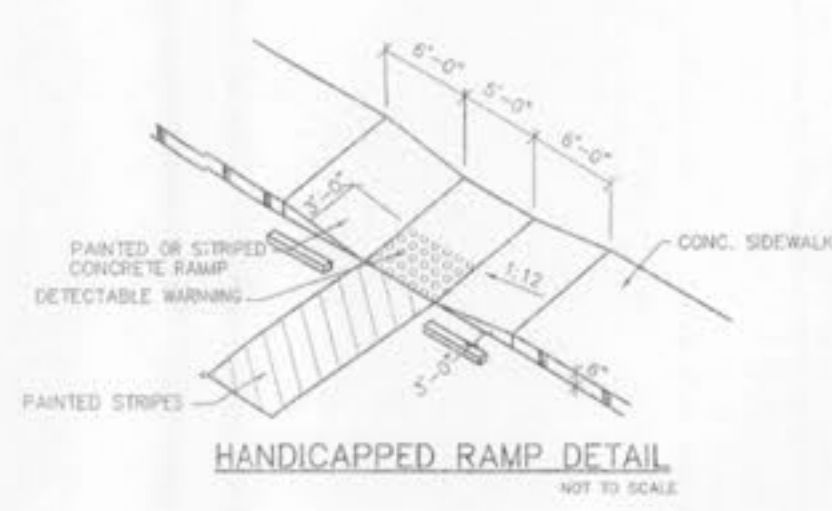

HANDICAPPED RAMP DETAIL
 NOT TO SCALE

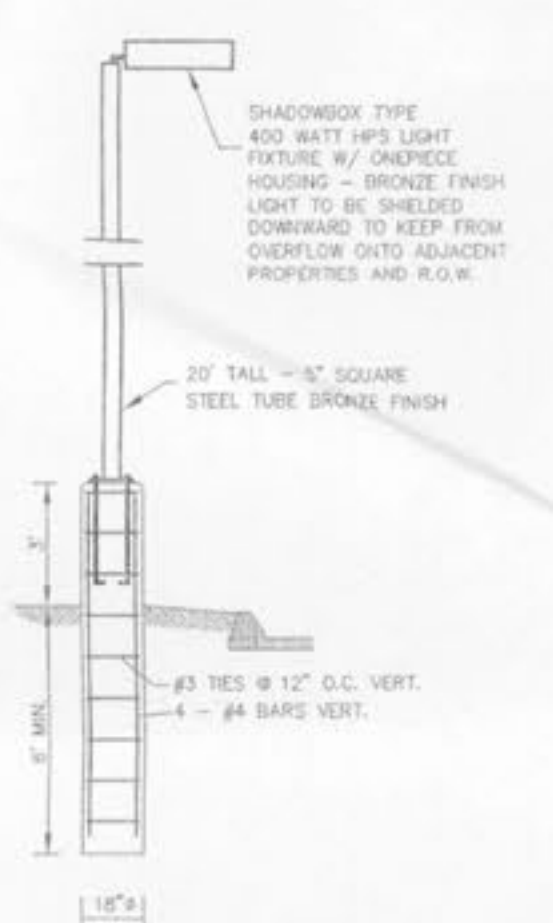

LIGHT POLE & BASE
 NOT TO SCALE

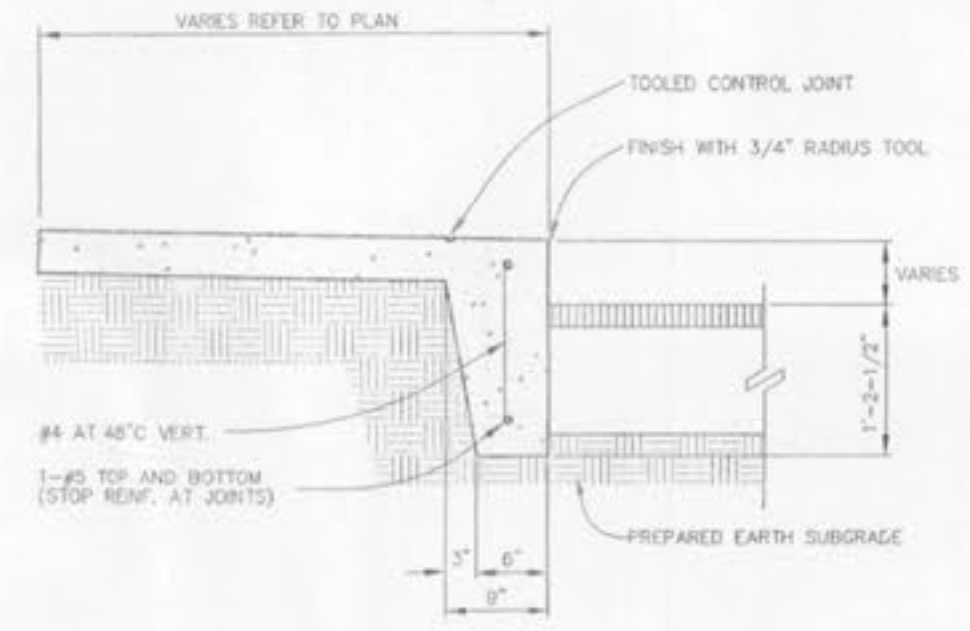

TURNED DOWN CONCRETE WALK
 NOT TO SCALE

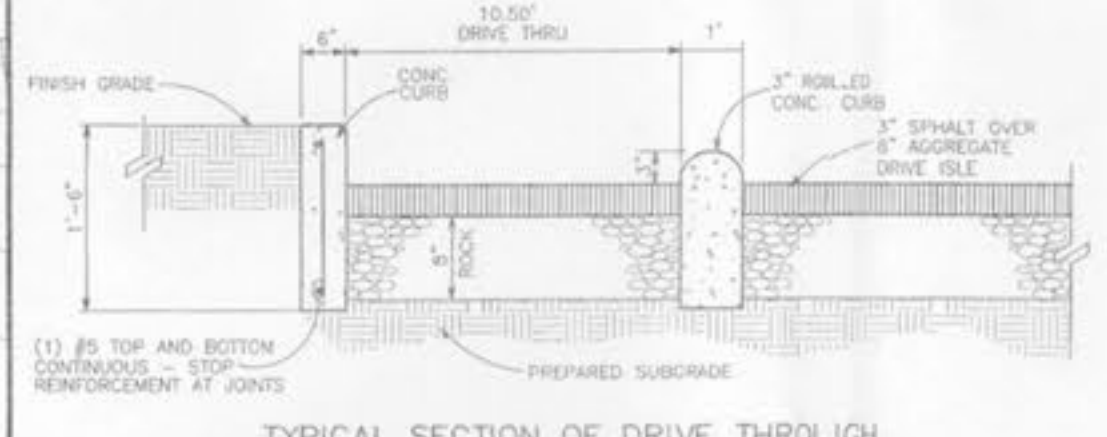

TYPICAL SECTION OF DRIVE THROUGH
 NOT TO SCALE

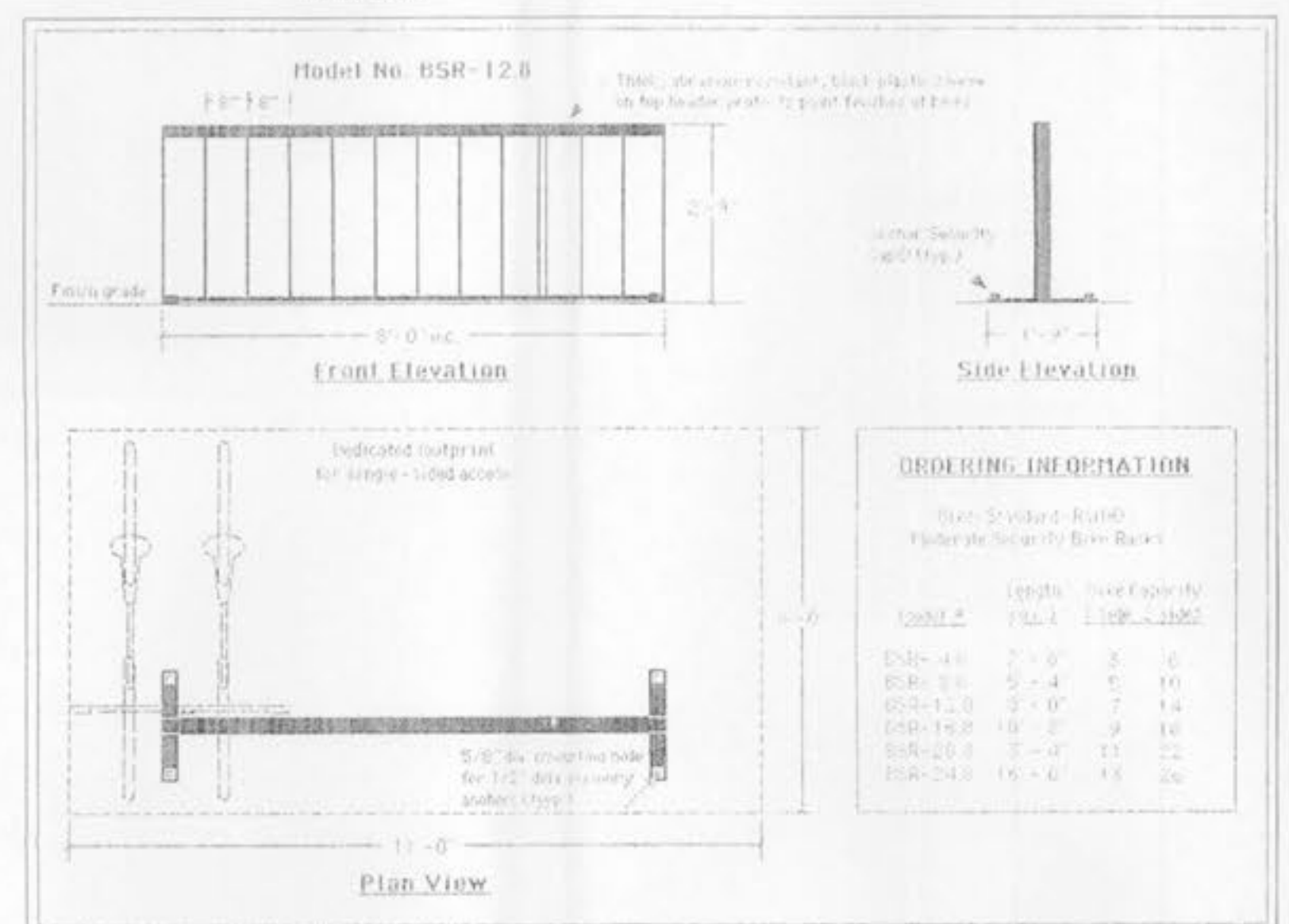

BIKE RACK DETAIL
 NOT TO SCALE

ORDERING INFORMATION

Item: Standard Round
 Material: Galvalume Steel

Code #	Length	Height	Capacity
BSR-12.8	7'-0"	5'-4"	5-10
BSR-12.10	9'-0"	5'-4"	7-14
BSR-12.12	11'-0"	5'-4"	9-16
BSR-12.15	13'-0"	5'-4"	11-22
BSR-12.18	15'-0"	5'-4"	13-26

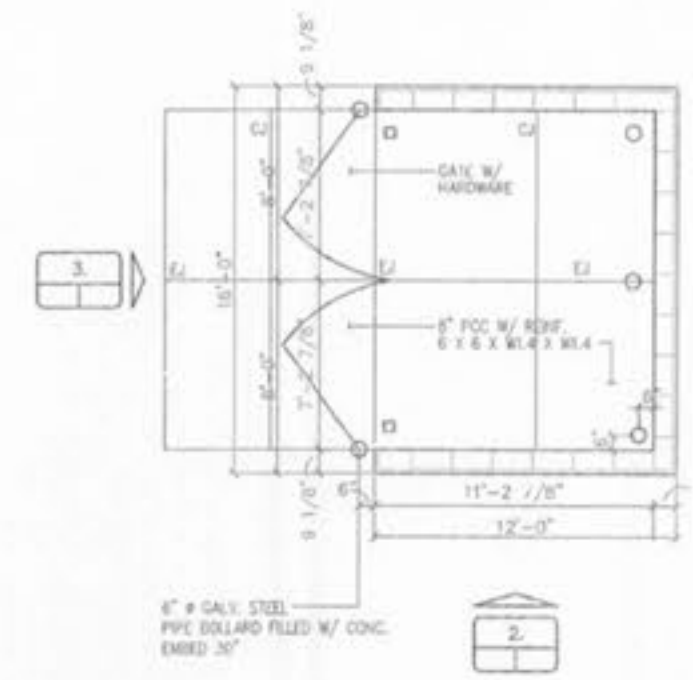

1. TRASH ENCLOSURE PLAN
 NOT TO SCALE

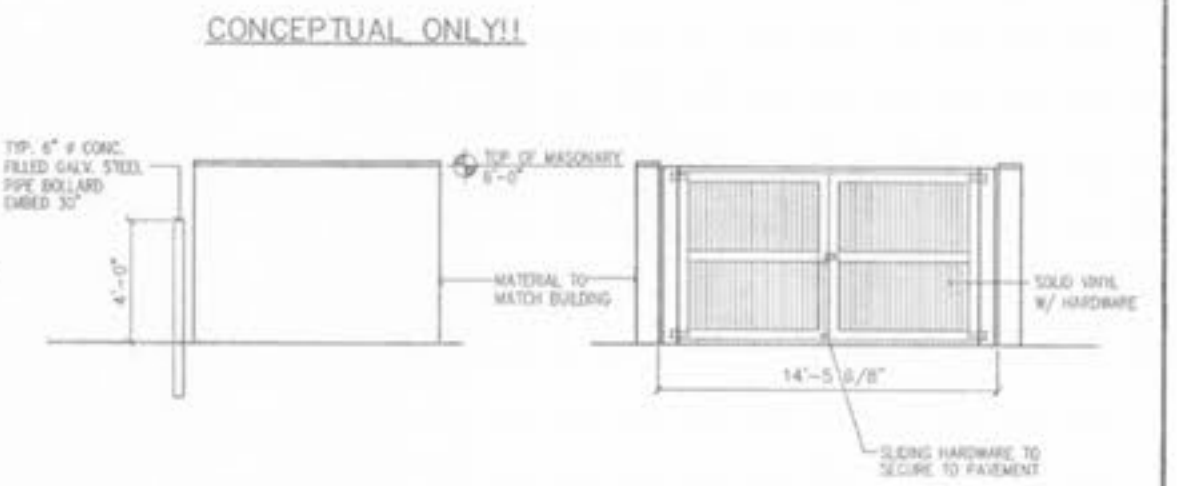

2. ELEVATION
 NOT TO SCALE

3. ELEVATION
 NOT TO SCALE

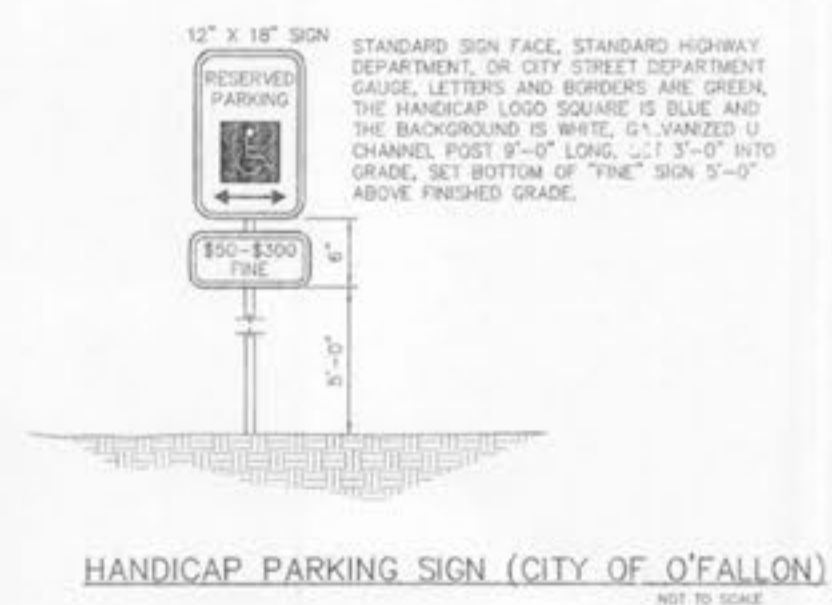

HANDICAP PARKING SIGN (CITY OF O'FALLON)
 NOT TO SCALE

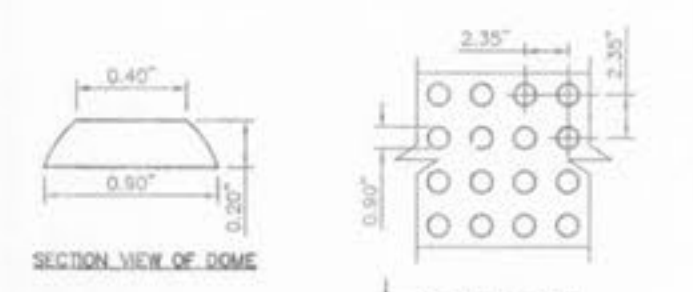

SECTION VIEW OF DOME
 NOT TO SCALE

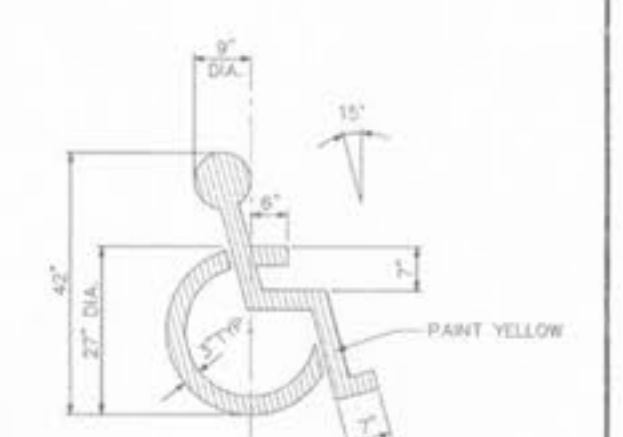

PAINTED HANDICAPPED PARKING SYMBOL
 NOT TO SCALE



PLAN VIEW OF A DETECTABLE WARNING SURFACE
 SHOWING DOMES ALIGNED IN ROWS, NOT SKIPPED CASUALLY.

TYPICAL DETAIL OF DETECTABLE WARNING SURFACE
 NOT TO SCALE

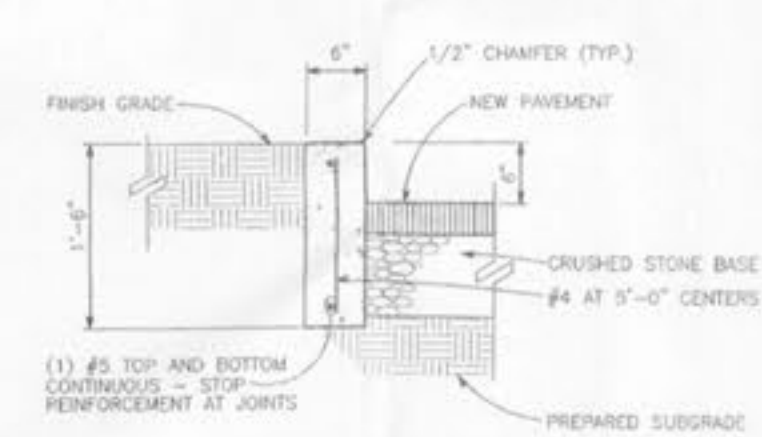

CONCRETE CURB DETAIL
 NOT TO SCALE

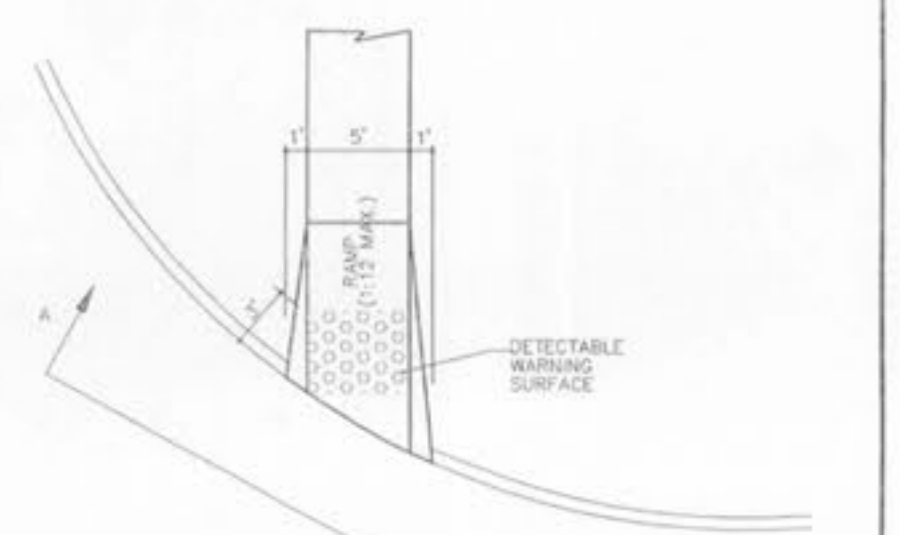

HANDICAPPED RAMP WITH DETECTABLE WARNING DETAIL
 NOT TO SCALE

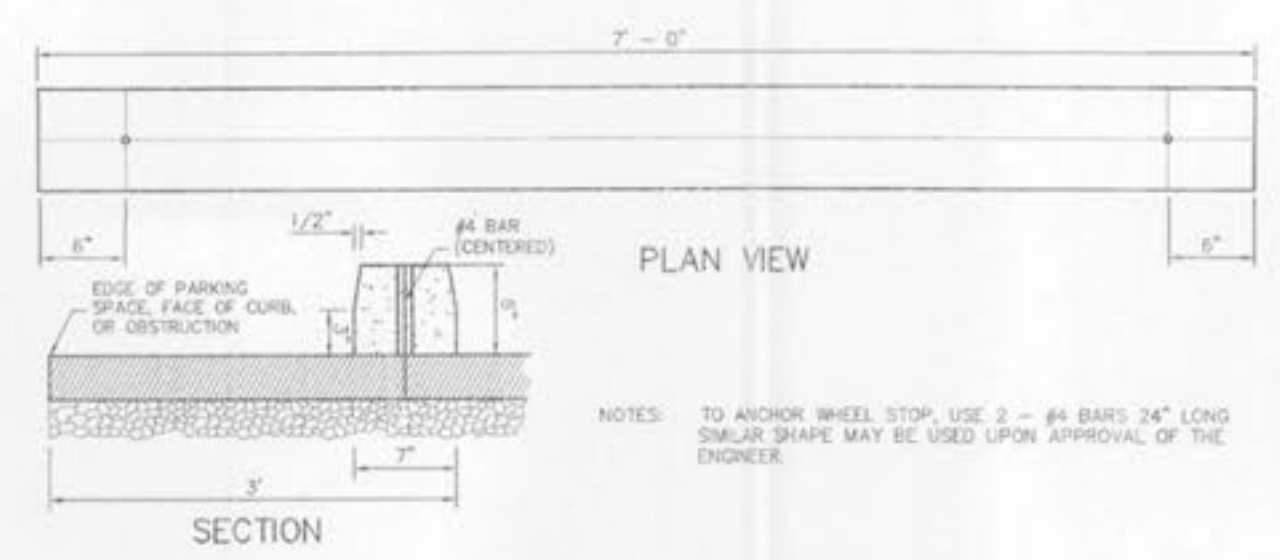

PRECAST CONCRETE WHEELSTOP

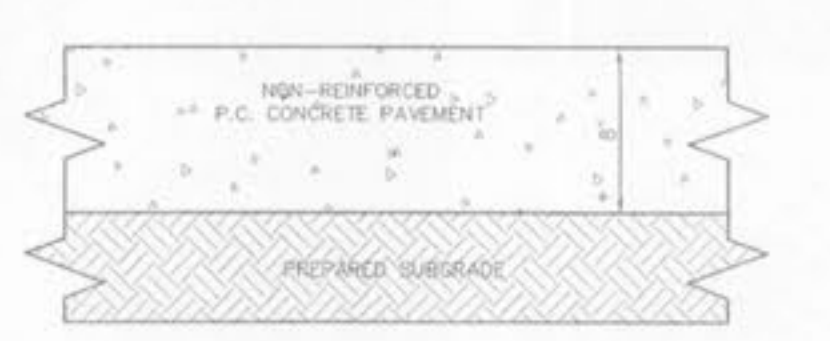

TRASH ENCLOSURE PAVEMENT DETAIL
 NOT TO SCALE

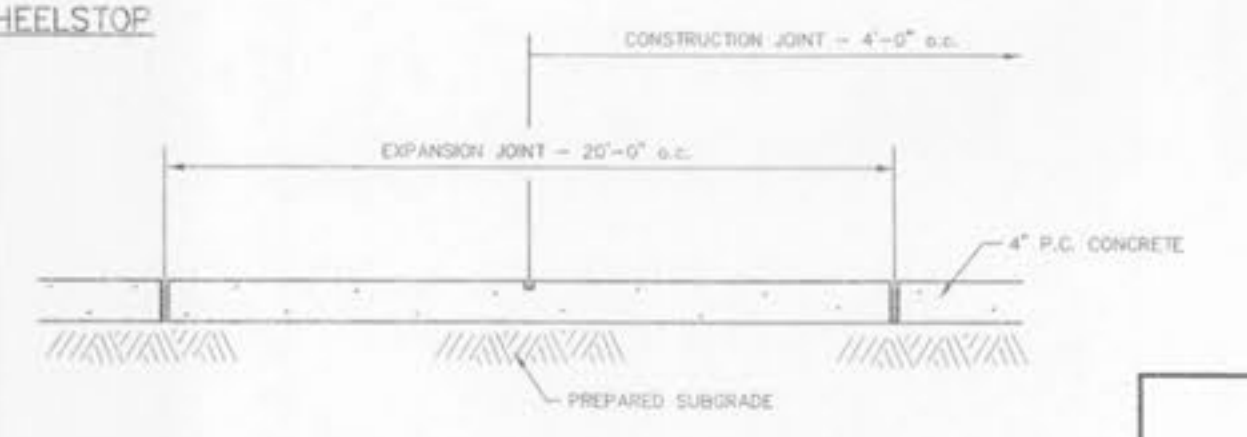

CONCRETE SIDEWALK DETAIL
 NOT TO SCALE

C:\125188\con.dwg, DETAILS(7), 8/10/2007 1:47:03 PM, Station 41 CF