

CALL	USE	Ø	STRAIGHT BARS
G-1	2, 3, OR 4 GRATE	3'-4"	
G-2	6 & 8 GRATE	5'-10"	
H-2	2 GRATE	3'-6"	
H-3	3 & 6 GRATE	4'-9"	
H-4	4 & 8 GRATE	6'-0"	

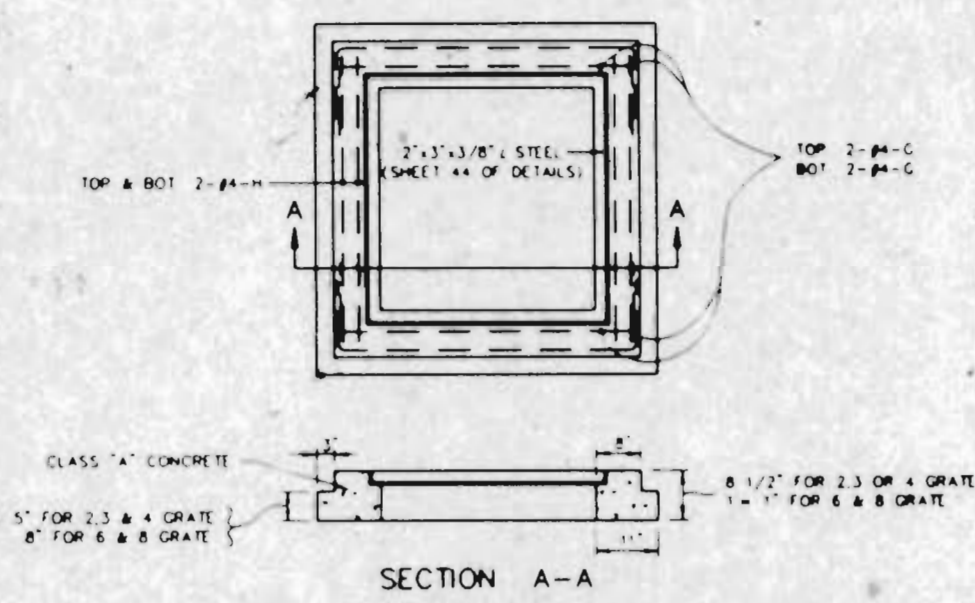

STEEL REQUIREMENTS FOR GRATE INLET SEAT  
METROPOLITAN ST. LOUIS SEWER DISTRICT  
Standard Details of Sewer Construction  
Dr. W.S.H. / Ch. J.C.K. / 1992 / SHEET 46

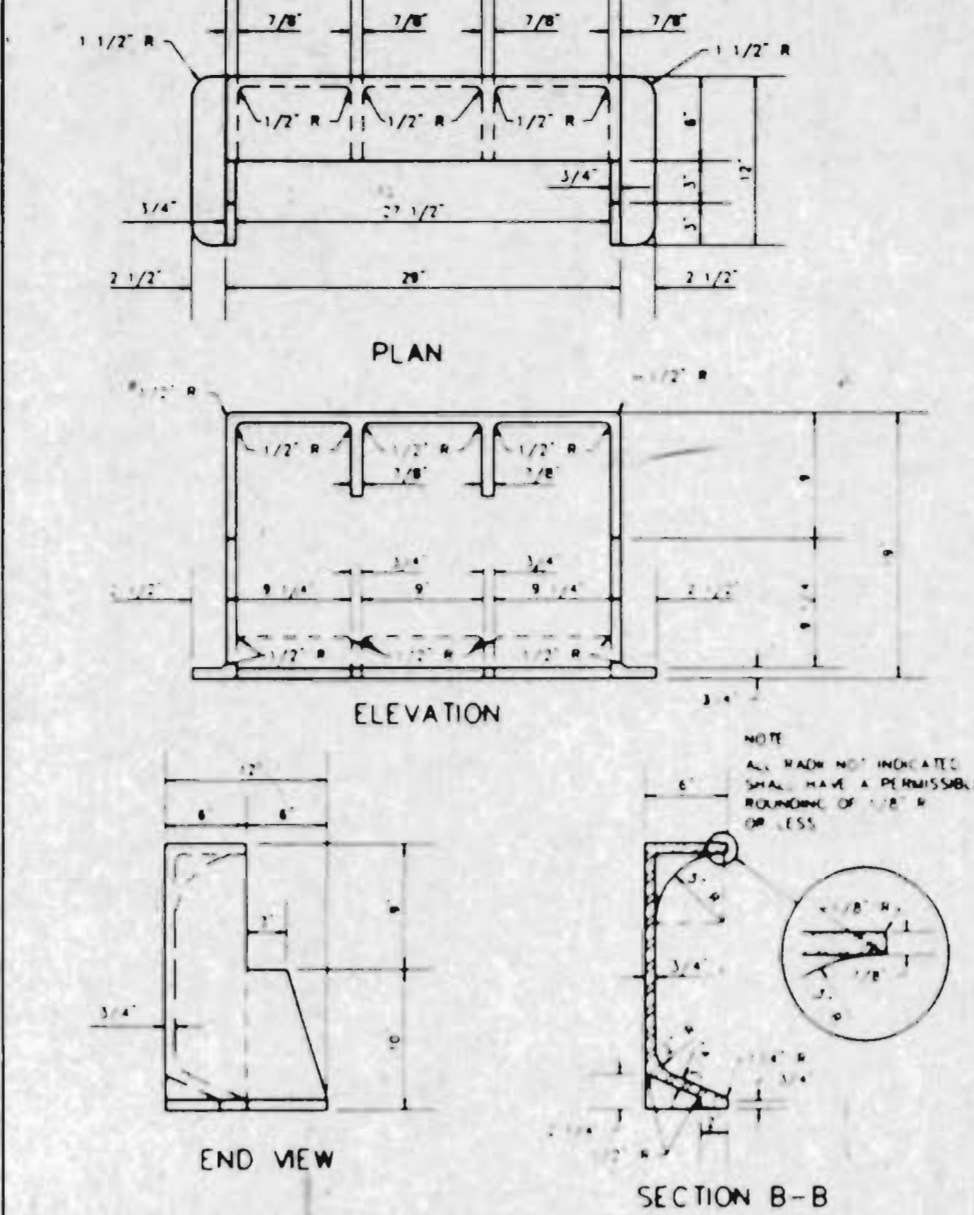

CAST IRON SIDE INTAKE UNIT FOR GRATED INLETS  
249 LBS  
METROPOLITAN ST. LOUIS SEWER DISTRICT  
Standard Details of Sewer Construction  
Dr. R.G.W. / Ch. J.C.K. / 1992 / SHEET 47

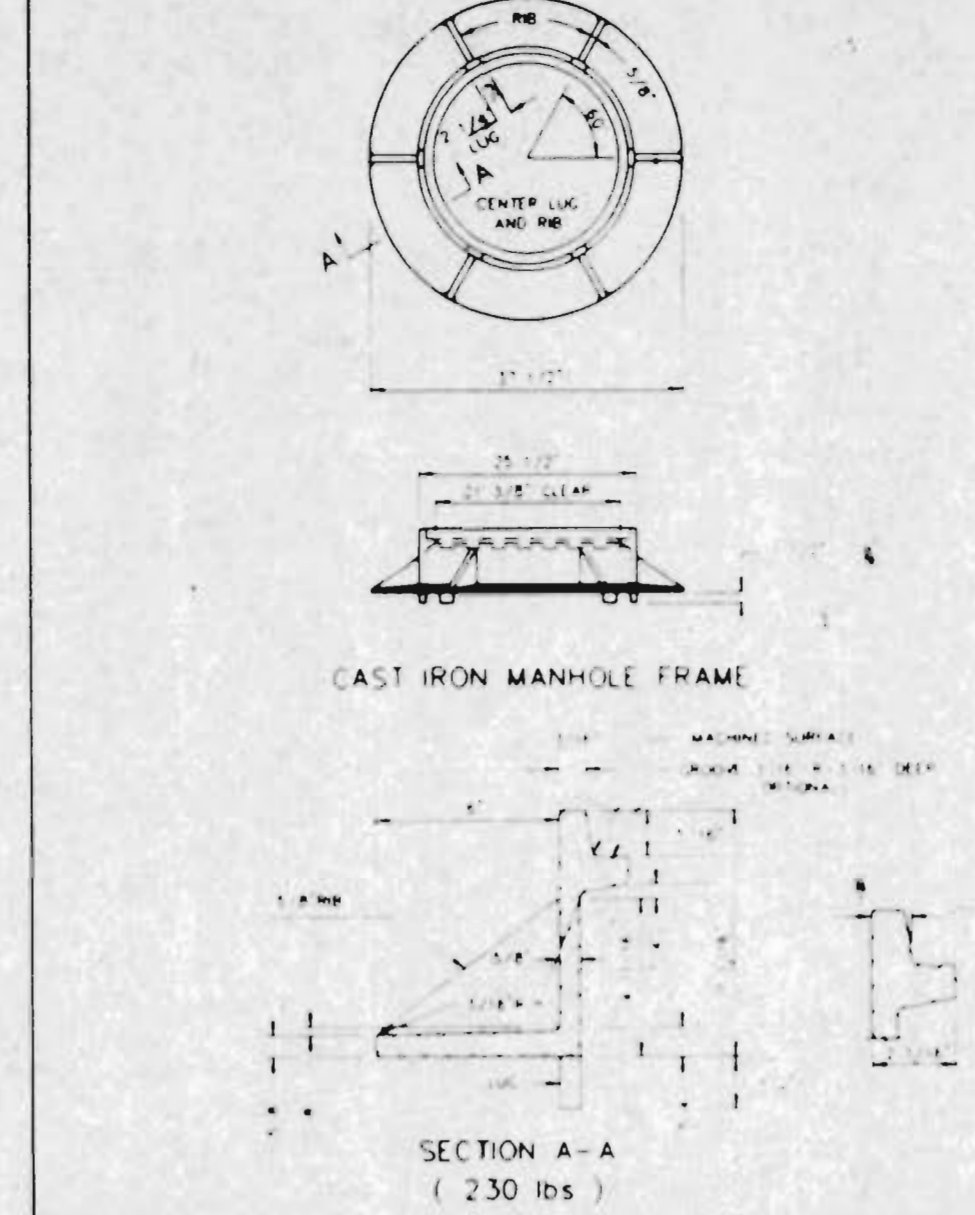

CAST IRON MANHOLE FRAME  
METROPOLITAN ST. LOUIS SEWER DISTRICT  
Standard Details of Sewer Construction  
Dr. G.A.P. / Ch. J.C.K. / 1992 / SHEET 48

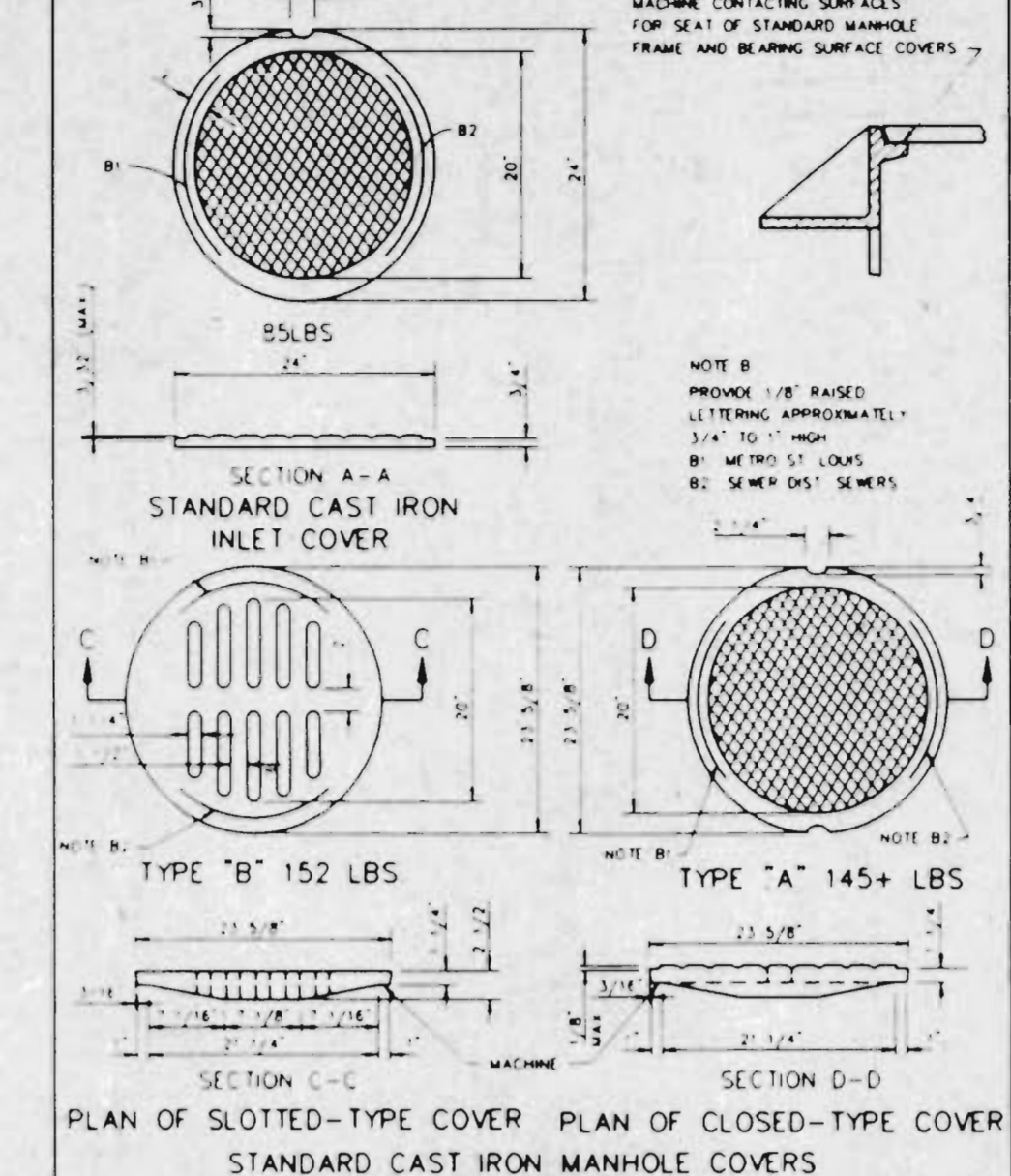

CAST IRON COVERS MANHOLES AND INLETS  
METROPOLITAN ST. LOUIS SEWER DISTRICT  
Standard Details of Sewer Construction  
Dr. R.G.W. / Ch. J.C.K. / 1992 / SHEET 49

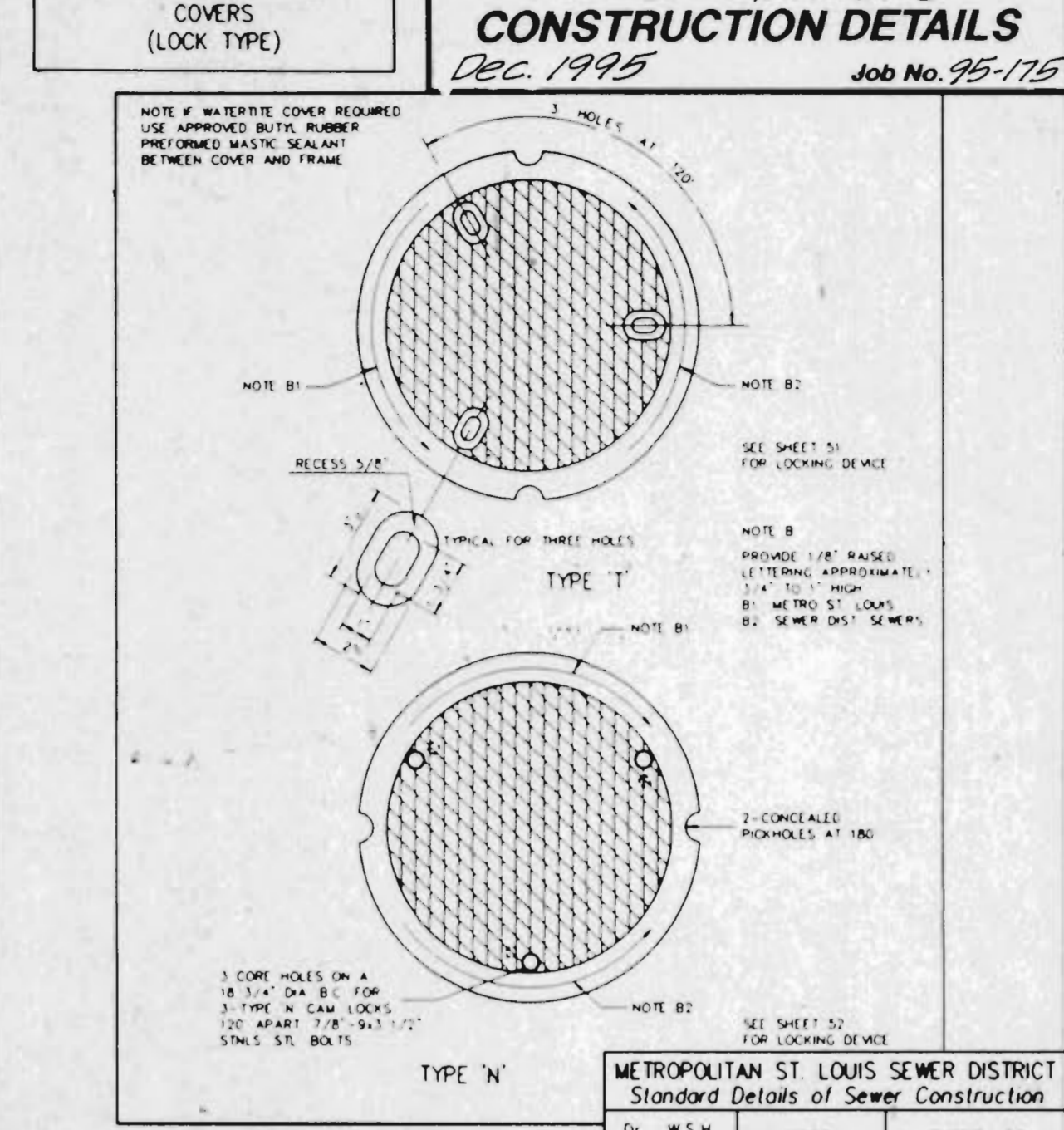

CAST IRON MANHOLE COVERS (LOCK TYPE)  
HIDDEN MEADOWS CONSTRUCTION DETAILS  
Dec. 1995 Job No. 95-175  
METROPOLITAN ST. LOUIS SEWER DISTRICT  
Standard Details of Sewer Construction  
Dr. W.S.H. / Ch. J.C.K. / 1992 / SHEET 50

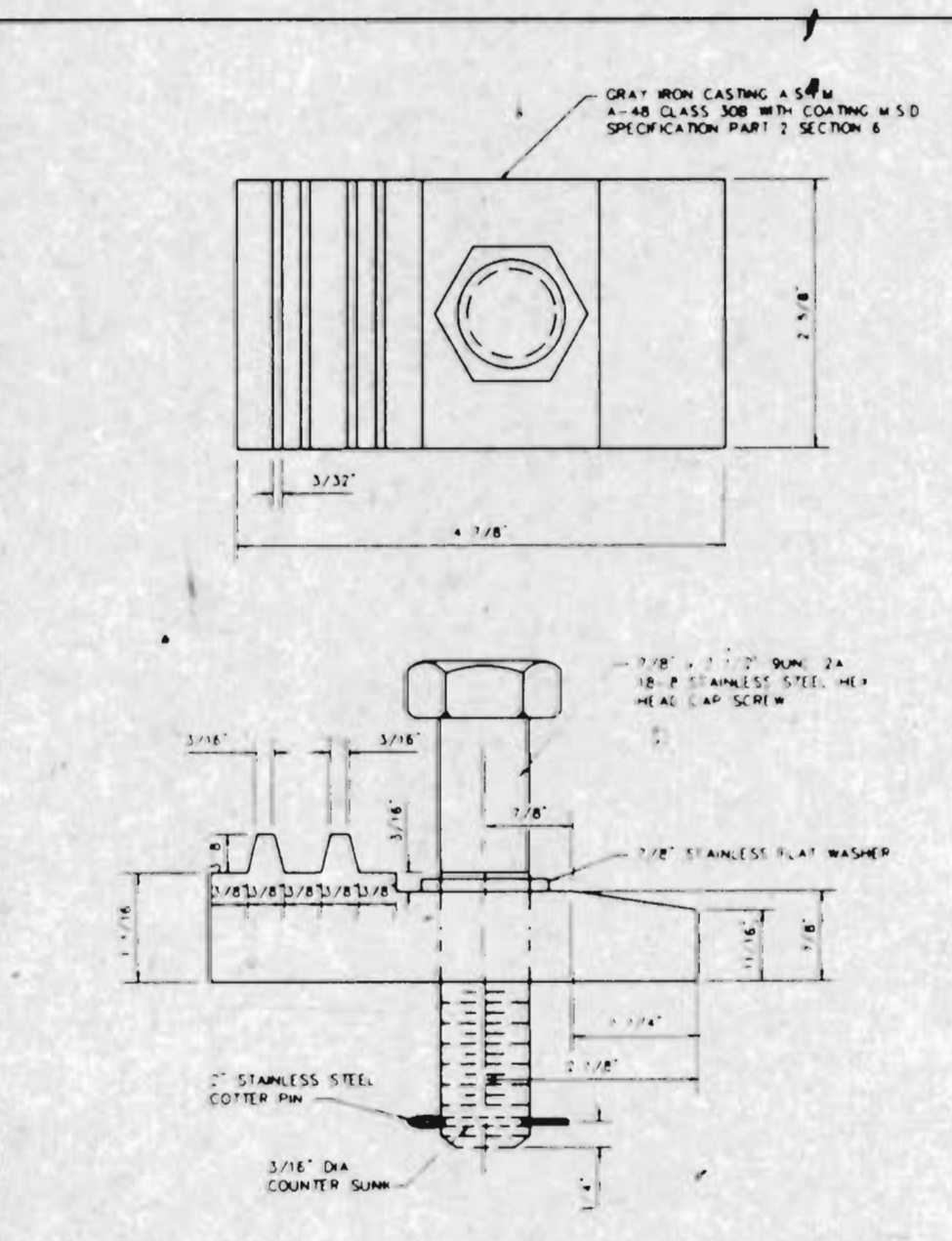

LOCKING DEVICE FOR TYPE 'T' LOCK TYPE MANHOLE COVER  
METROPOLITAN ST. LOUIS SEWER DISTRICT  
Standard Details of Sewer Construction  
Dr. R.G.W. / Ch. J.C.K. / 1992 / SHEET 51

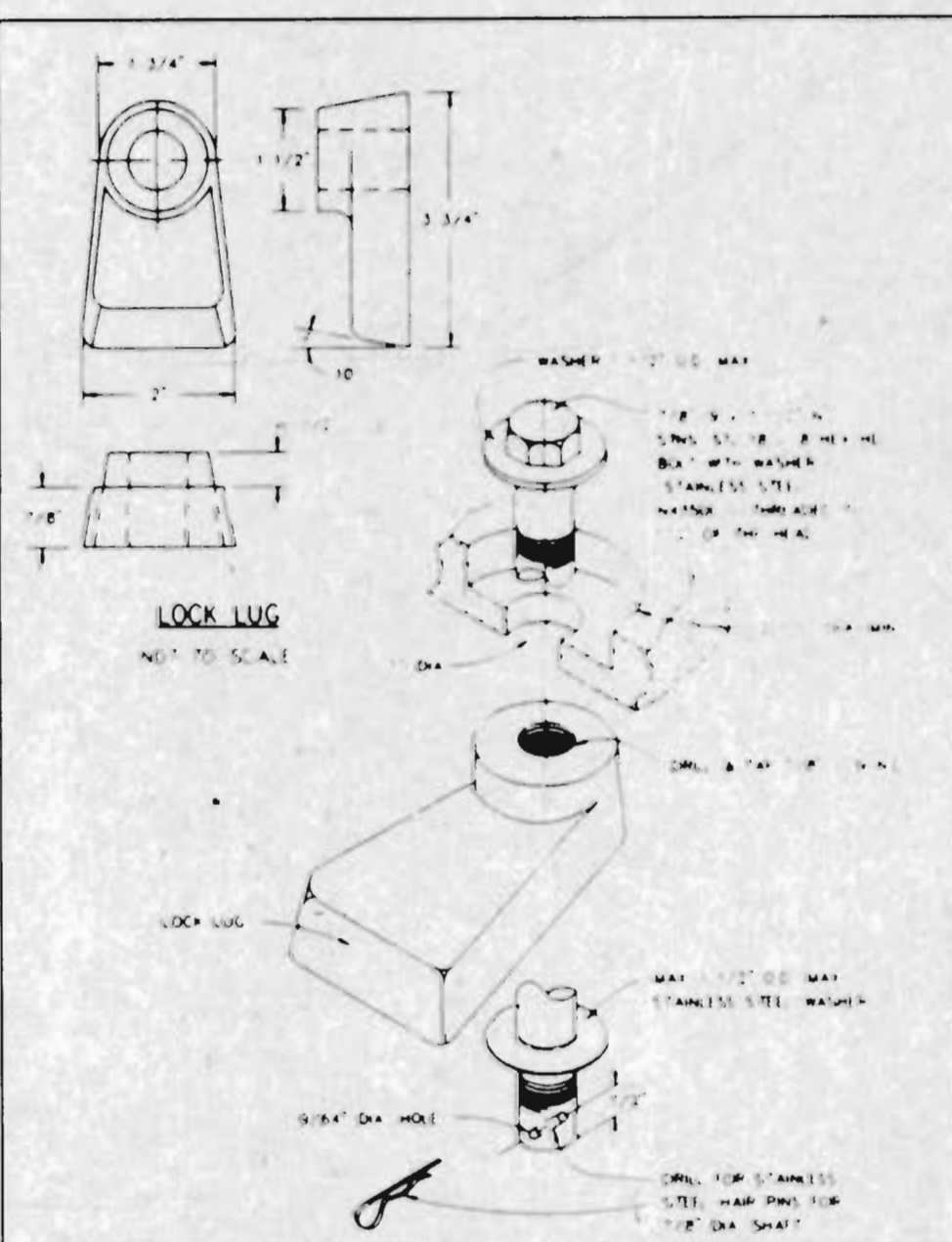

LOCKING DEVICE FOR TYPE 'N' LOCK TYPE MANHOLE COVER  
METROPOLITAN ST. LOUIS SEWER DISTRICT  
Standard Details of Sewer Construction  
Dr. J.L.G. / Ch. J.C.K. / 1992 / SHEET 52

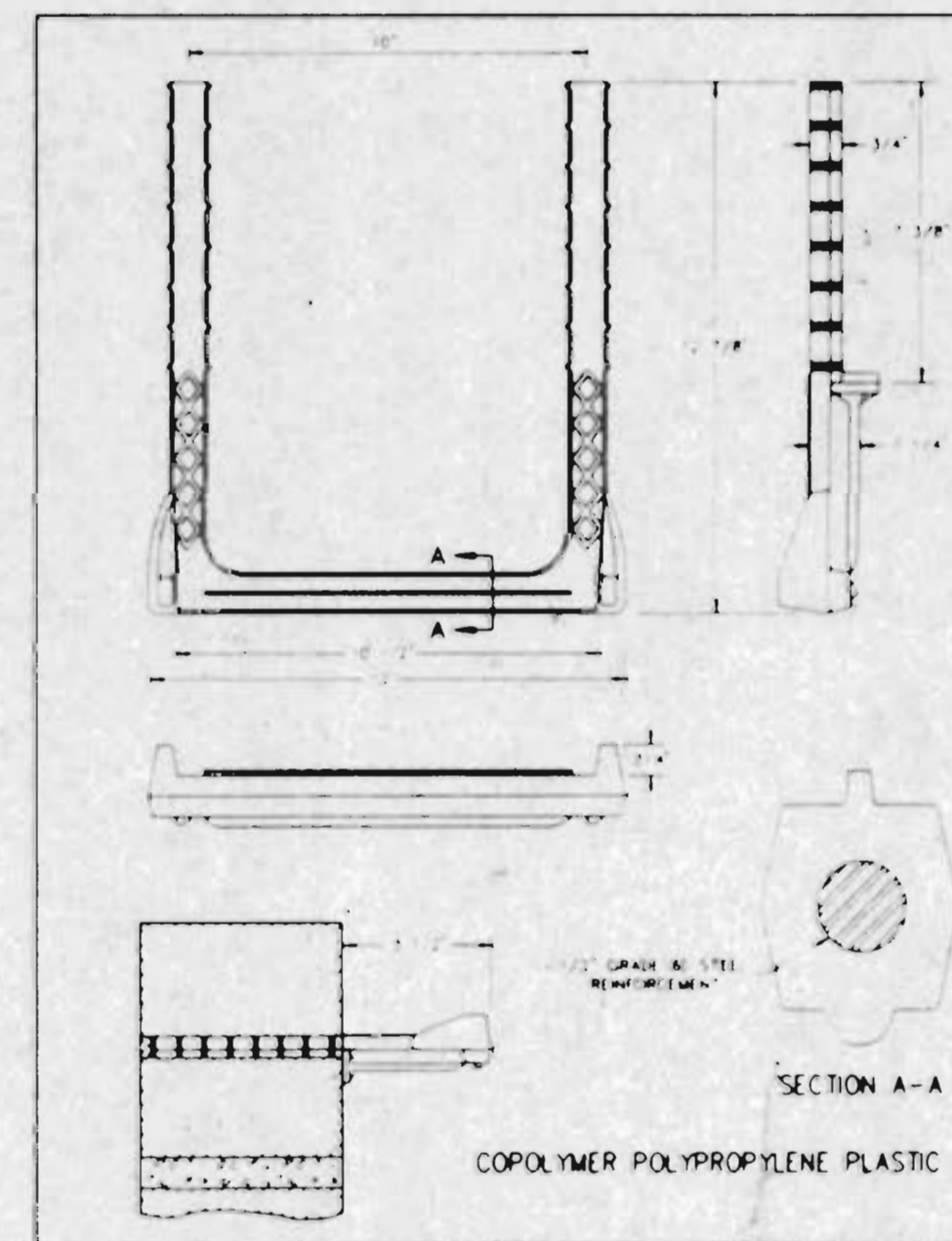

PSI-B MANHOLE STEP INTO JOINT  
METROPOLITAN ST. LOUIS SEWER DISTRICT  
Standard Details of Sewer Construction  
Dr. W.S.H. / Ch. J.C.K. / 1992 / SHEET 53

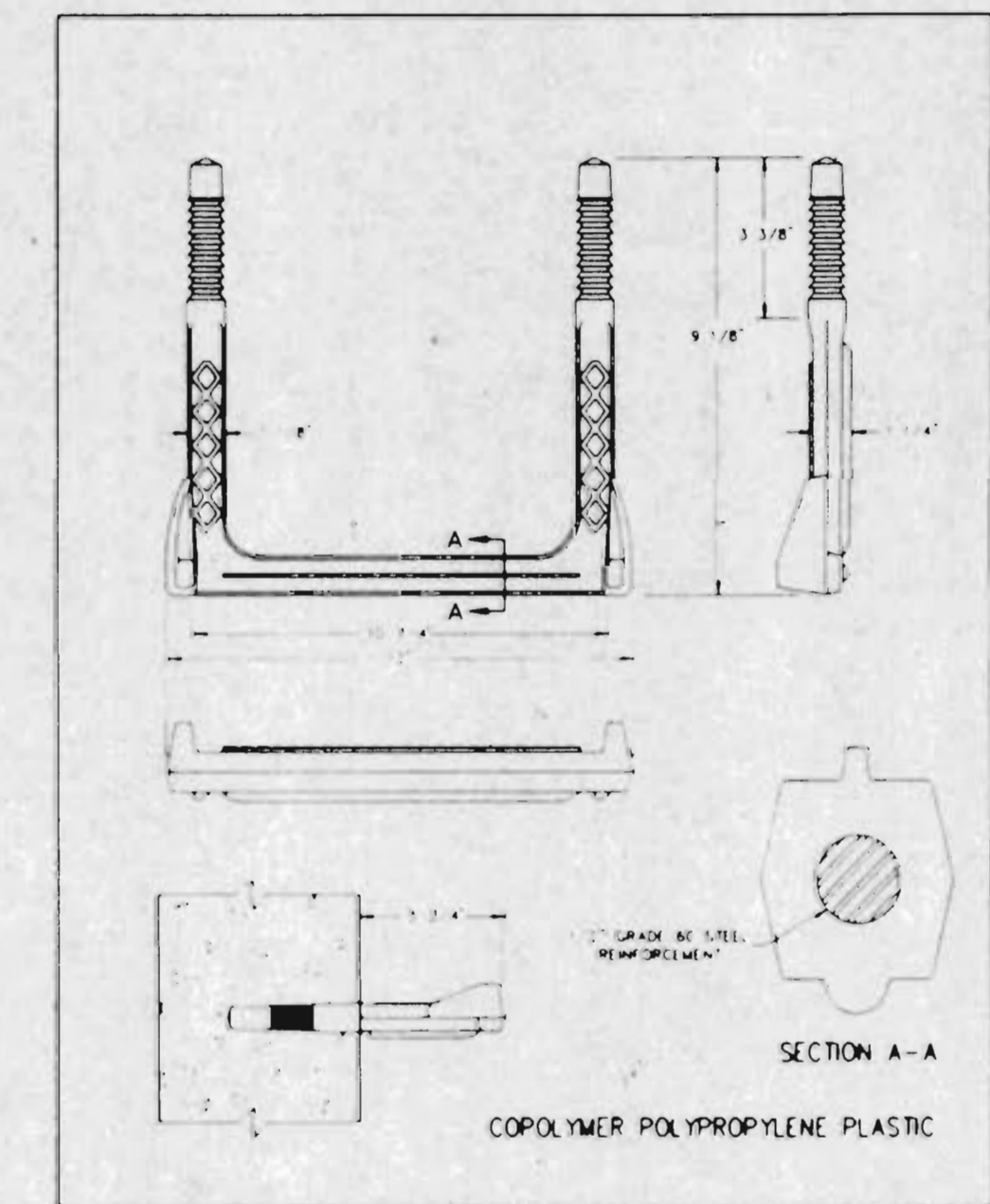

MANHOLE STEP FOR PRECAST MANHOLE  
METROPOLITAN ST. LOUIS SEWER DISTRICT  
Standard Details of Sewer Construction  
Dr. D.A.B. / Ch. J.C.K. / 1992 / SHEET 54

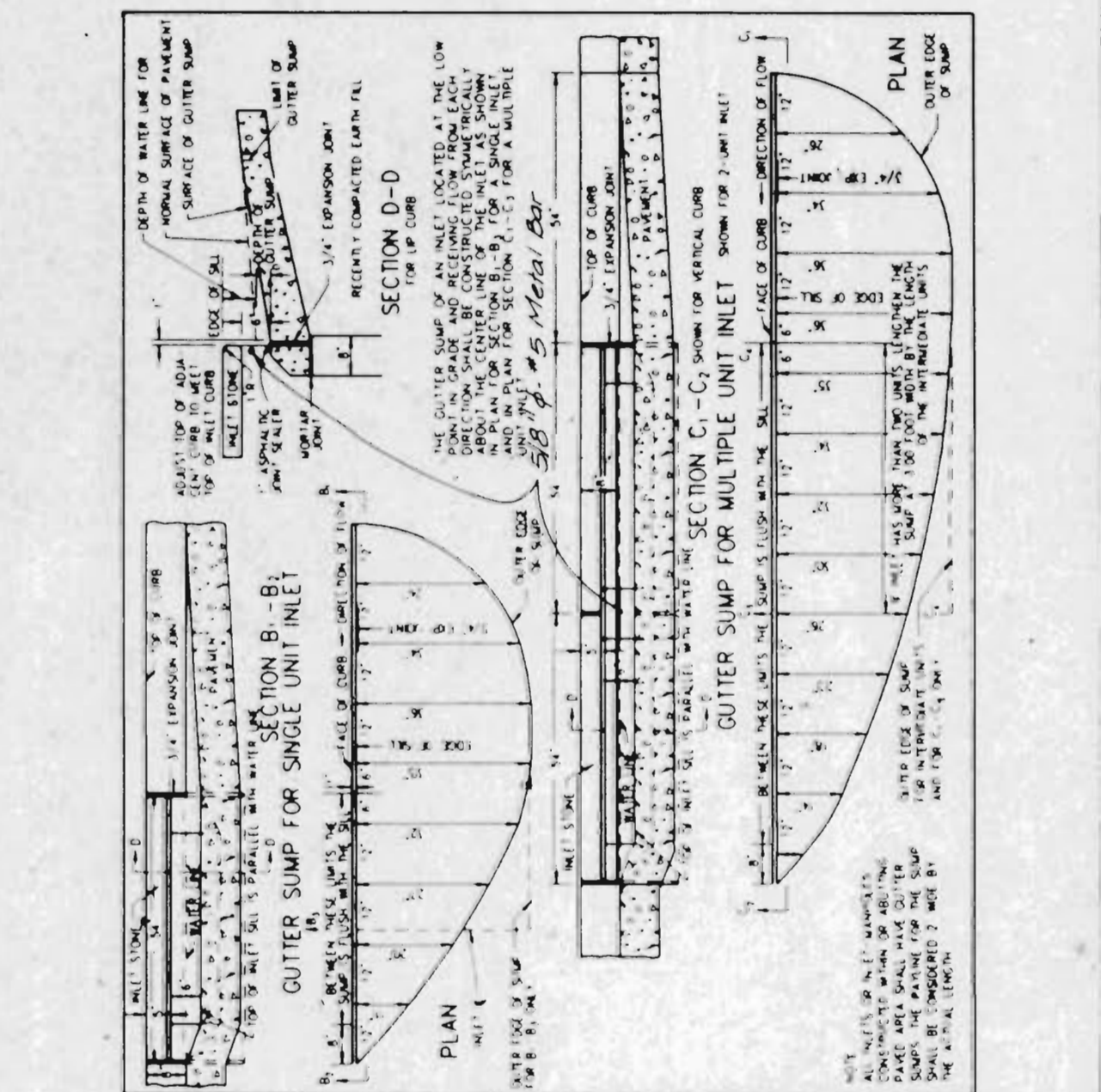

GUTTER SUMPS FOR VERTICAL CURB  
METROPOLITAN ST. LOUIS SEWER DISTRICT  
Standard Details of Sewer Construction  
Dr. W.S.H. / Ch. J.C.K. / 1992 / SHEET 55

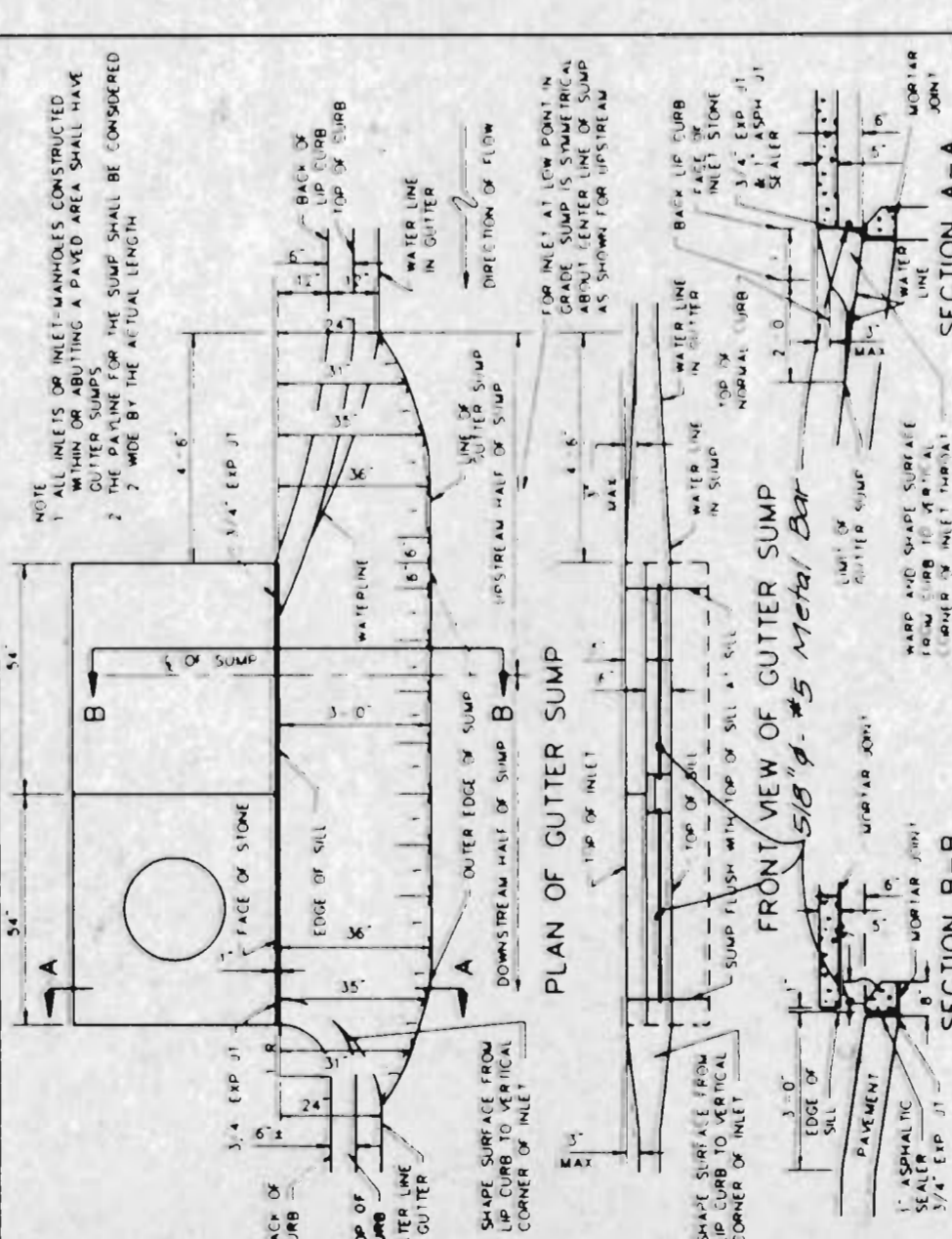

GUTTER SUMP FOR LIP CURB  
METROPOLITAN ST. LOUIS SEWER DISTRICT  
Standard Details of Sewer Construction  
Dr. R.G.W. / Ch. J.C.K. / 1992 / SHEET 56

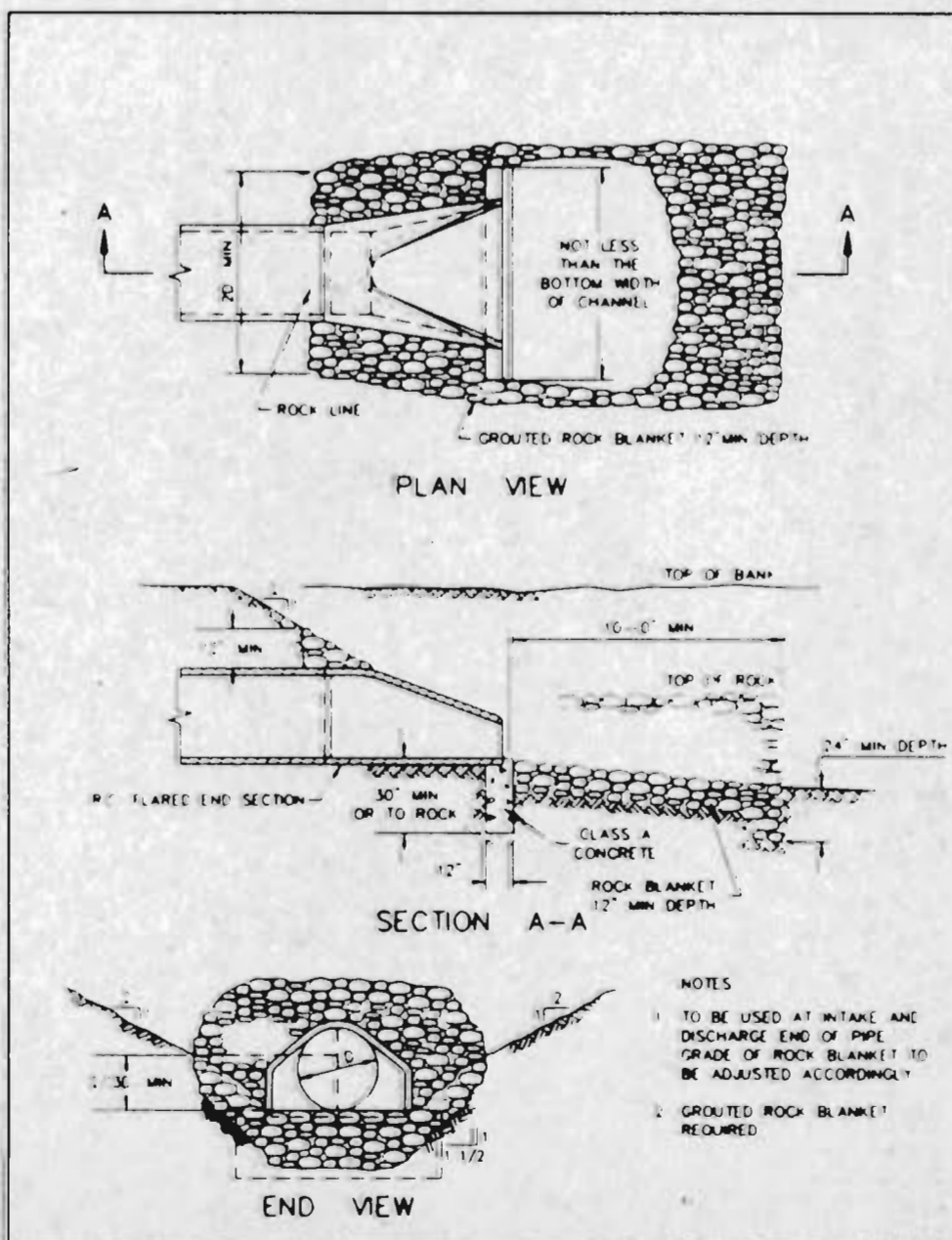

FLARED END SECTION  
METROPOLITAN ST. LOUIS SEWER DISTRICT  
Standard Details of Sewer Construction  
Dr. W.S.H. / Ch. J.C.K. / 1992 / SHEET 57

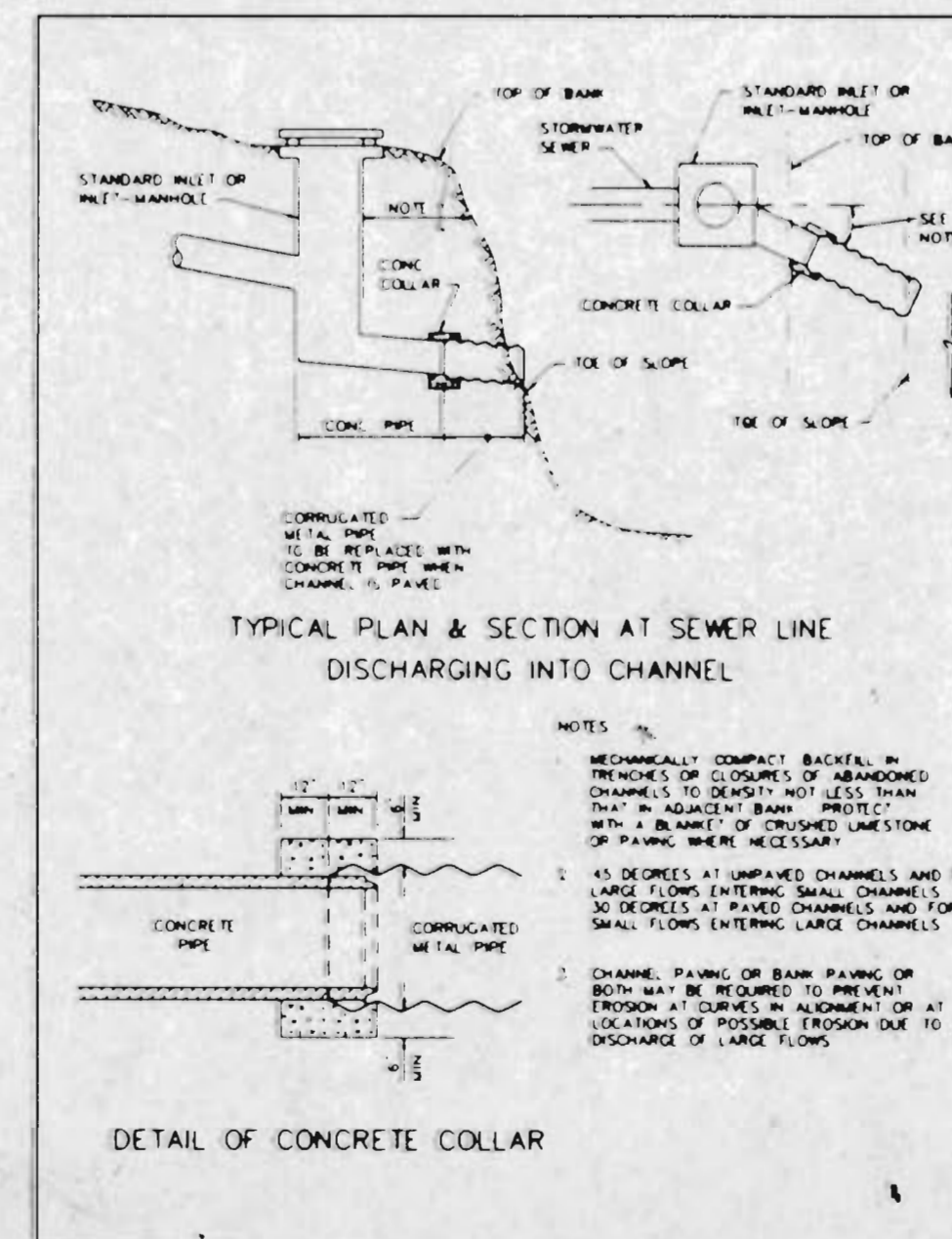

STORMWATER CHANNELS  
METROPOLITAN ST. LOUIS SEWER DISTRICT  
Standard Details of Sewer Construction  
Dr. R.G.W. / Ch. J.C.K. / 1992 / SHEET 58

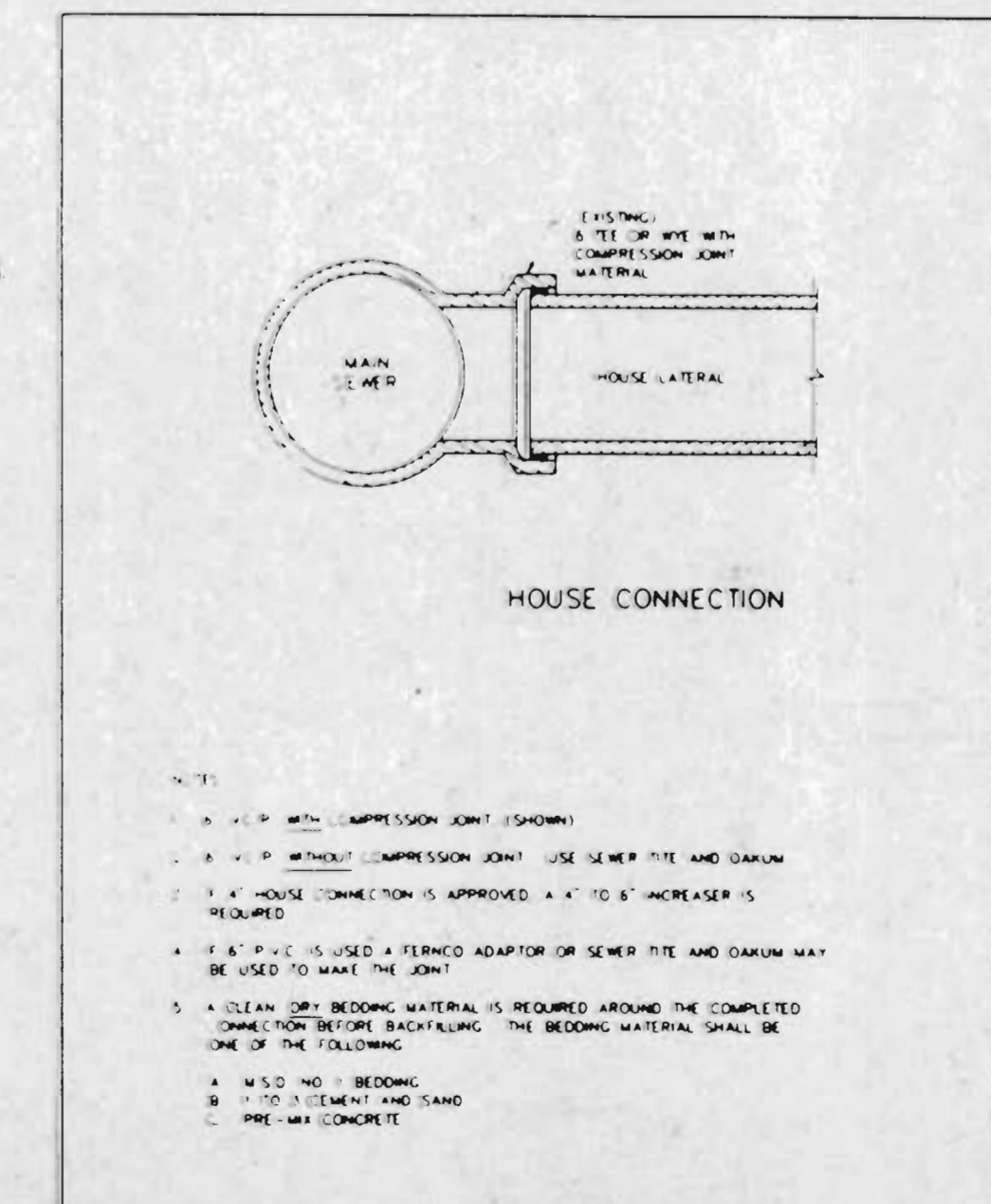

HOUSE CONNECTION TO EXISTING TEE OR WYE  
METROPOLITAN ST. LOUIS SEWER DISTRICT  
Standard Details of Sewer Construction  
Dr. D.A.B. / Ch. J.C.K. / 1992 / SHEET 59

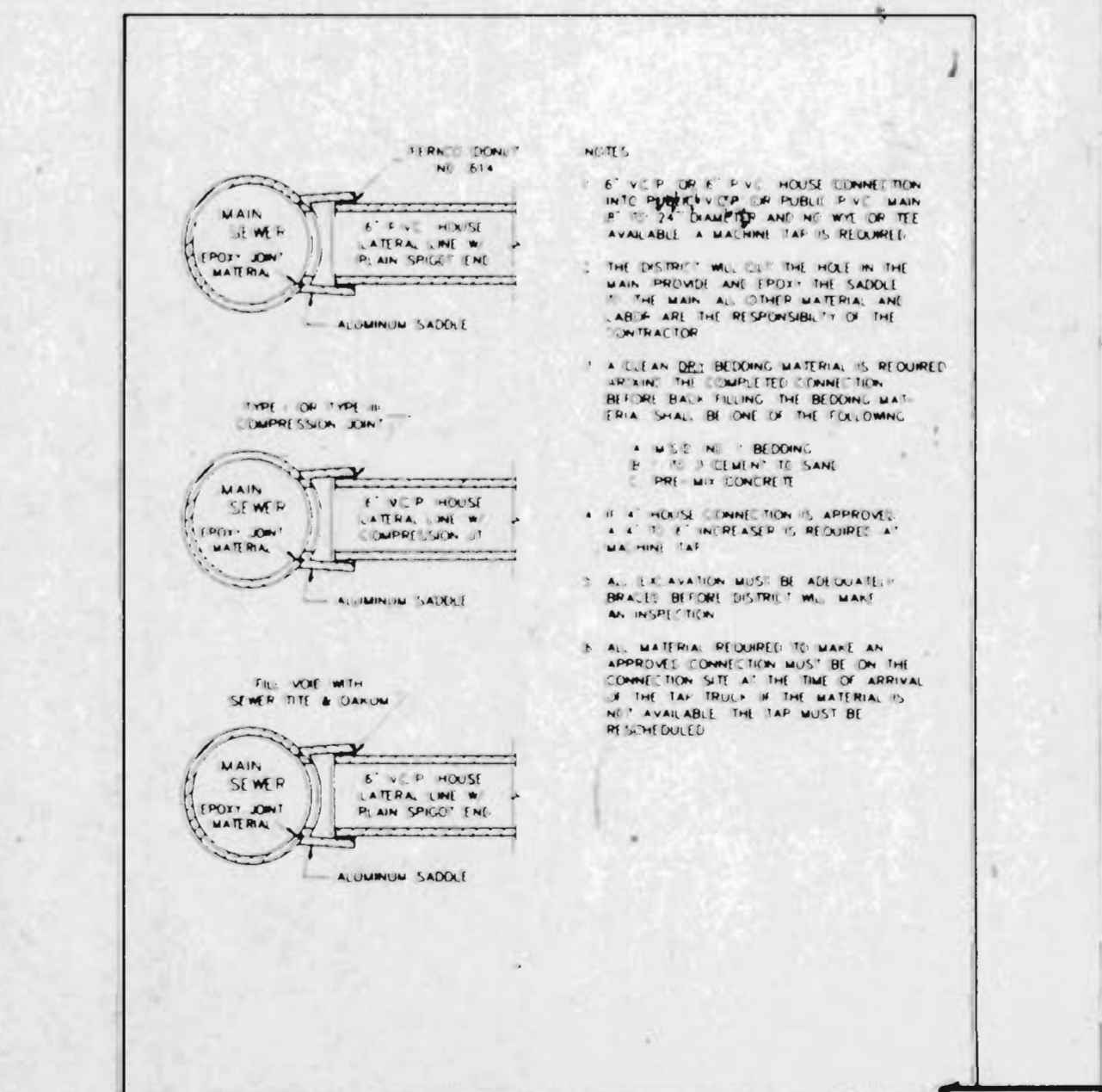

MACHINE TAP  
METROPOLITAN ST. LOUIS SEWER DISTRICT  
Standard Details of Sewer Construction  
Dr. W.S.H. / Ch. J.C.K. / 1992 / SHEET 60