

DETAIL "A" AT CONCRETE WALK AND CURB
NO SCALE

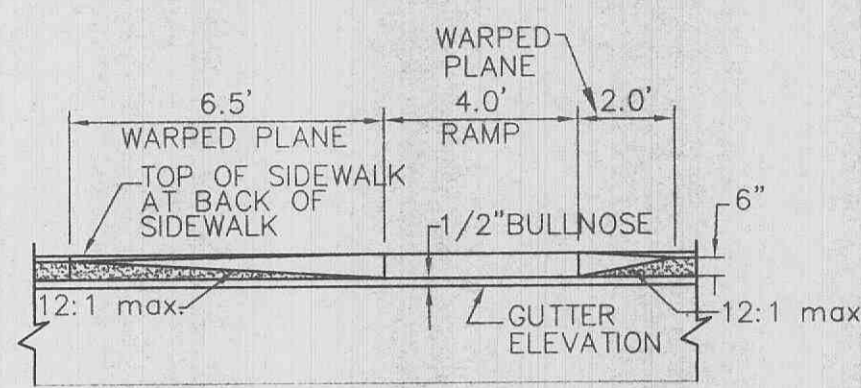

SECTION "B"-"B" AT HANDICAP RAMP
NO SCALE

SECTION "B"-"B" AT HANDICAP RAMP (OPPOSITE HAND)
NO SCALE

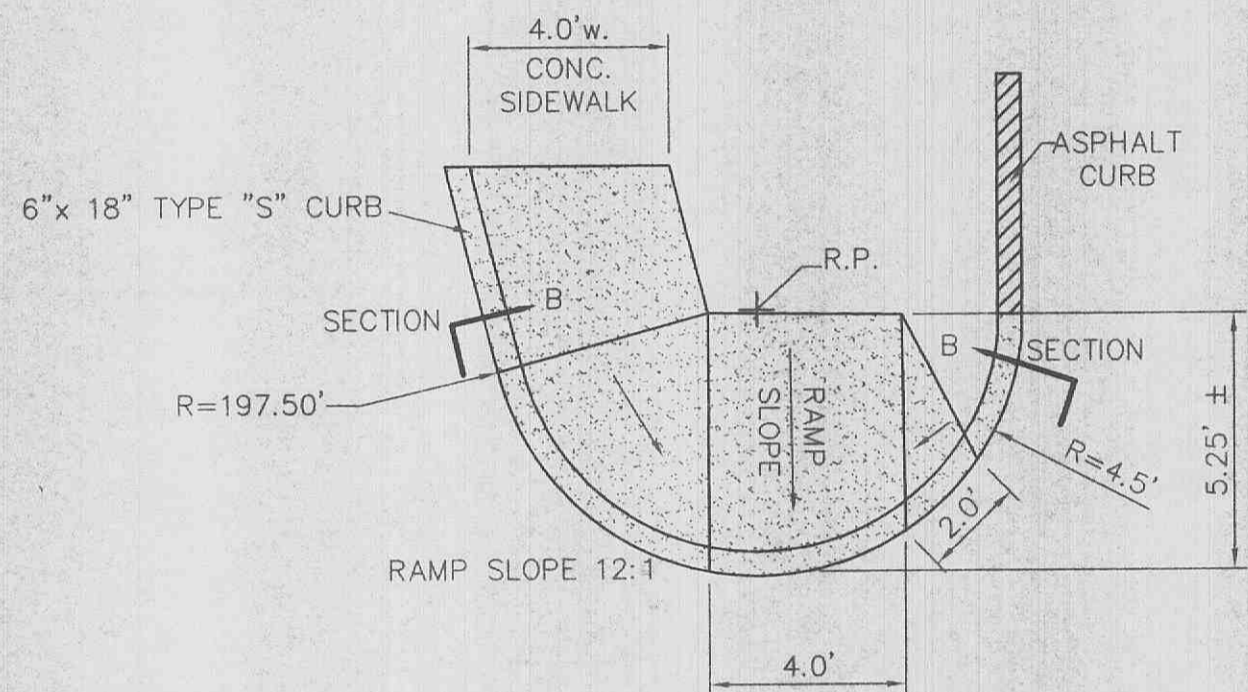

DETAIL "B" AT HANDICAP RAMP
NO SCALE

DETAIL "B" AT HANDICAP RAMP (OPPOSITE HAND)
NO SCALE

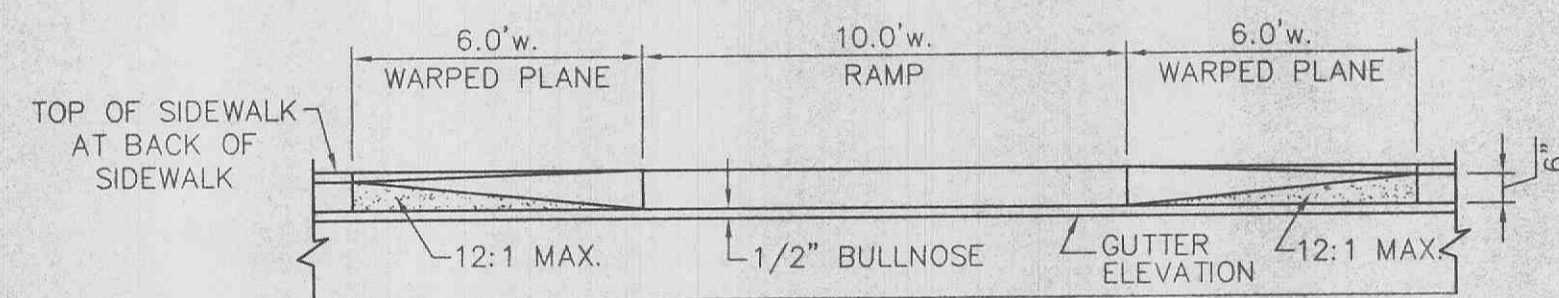

SECTION "C"-"C" AT HANDICAP RAMP
NO SCALE



DETAIL "C" AT HANDICAP RAMP
NO SCALE

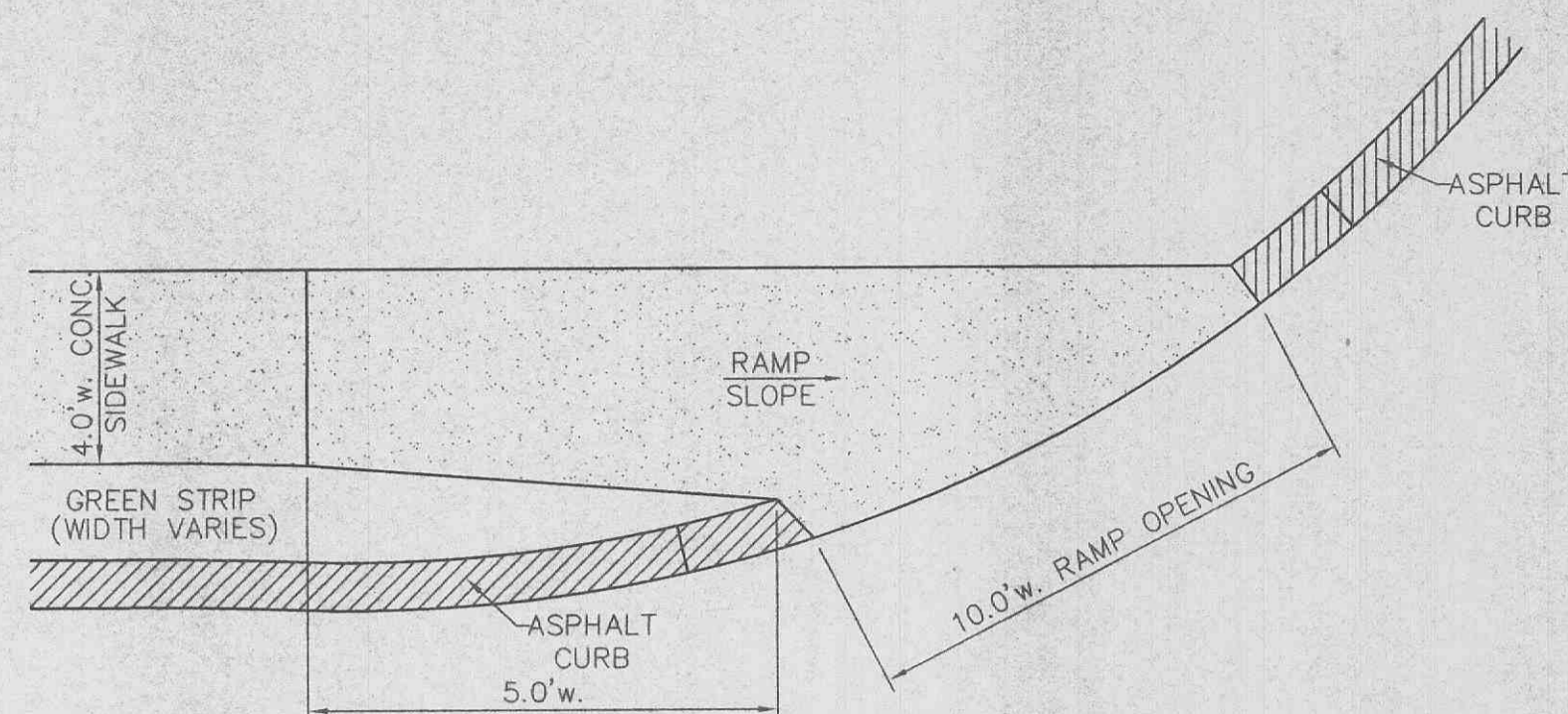

DETAIL "D" AT HANDICAP RAMP
NO SCALE

DETAIL "D" AT HANDICAP RAMP (OPPOSITE HAND)
NO SCALE

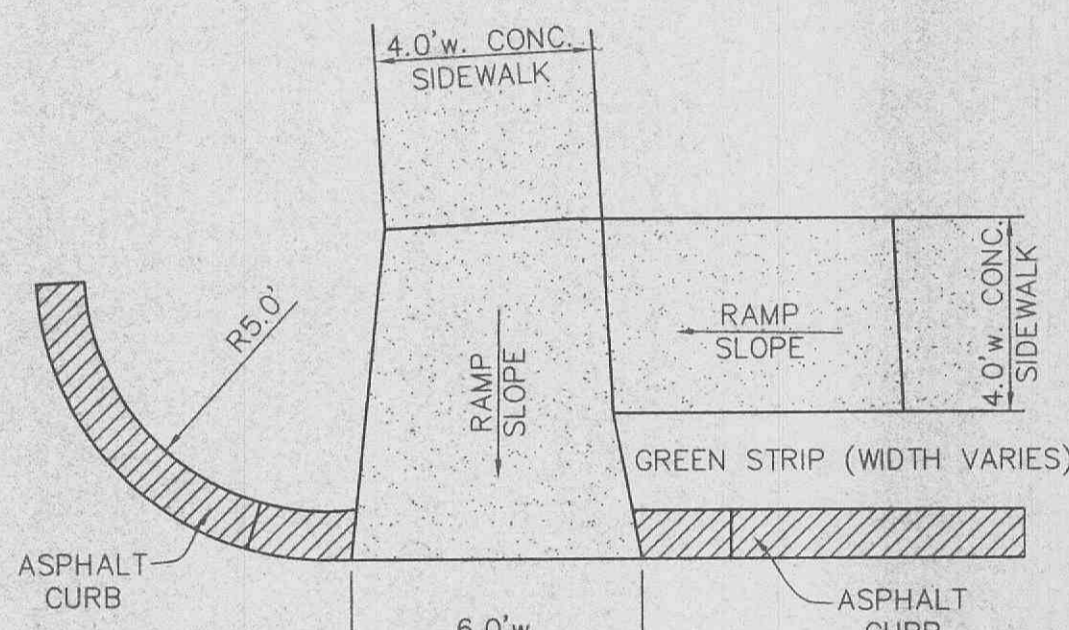

DETAIL "E" AT HANDICAP RAMP
NO SCALE

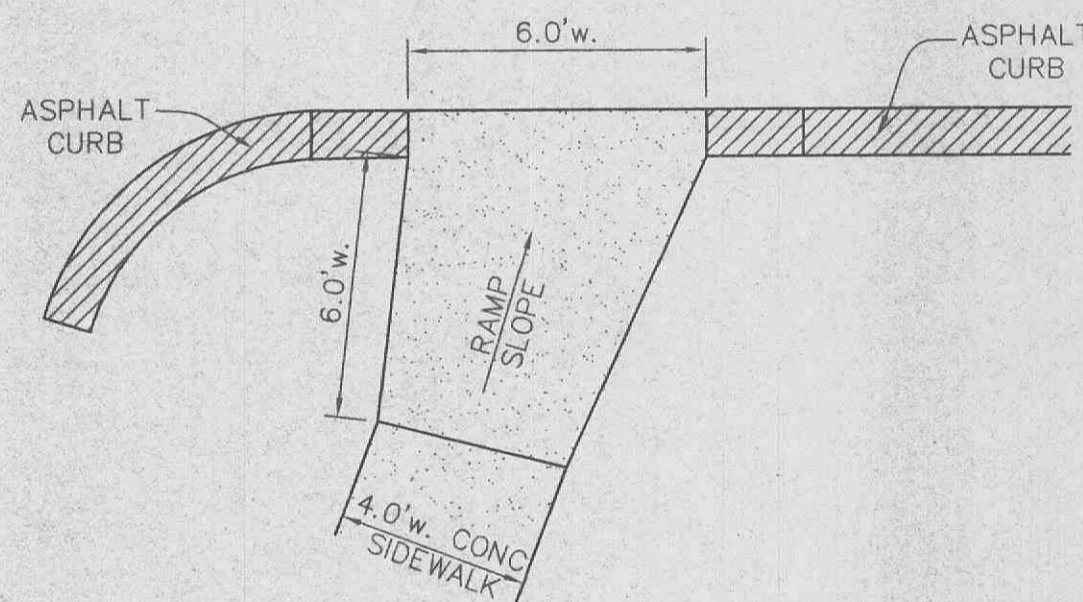

DETAIL "F" AT HANDICAP RAMP
NO SCALE

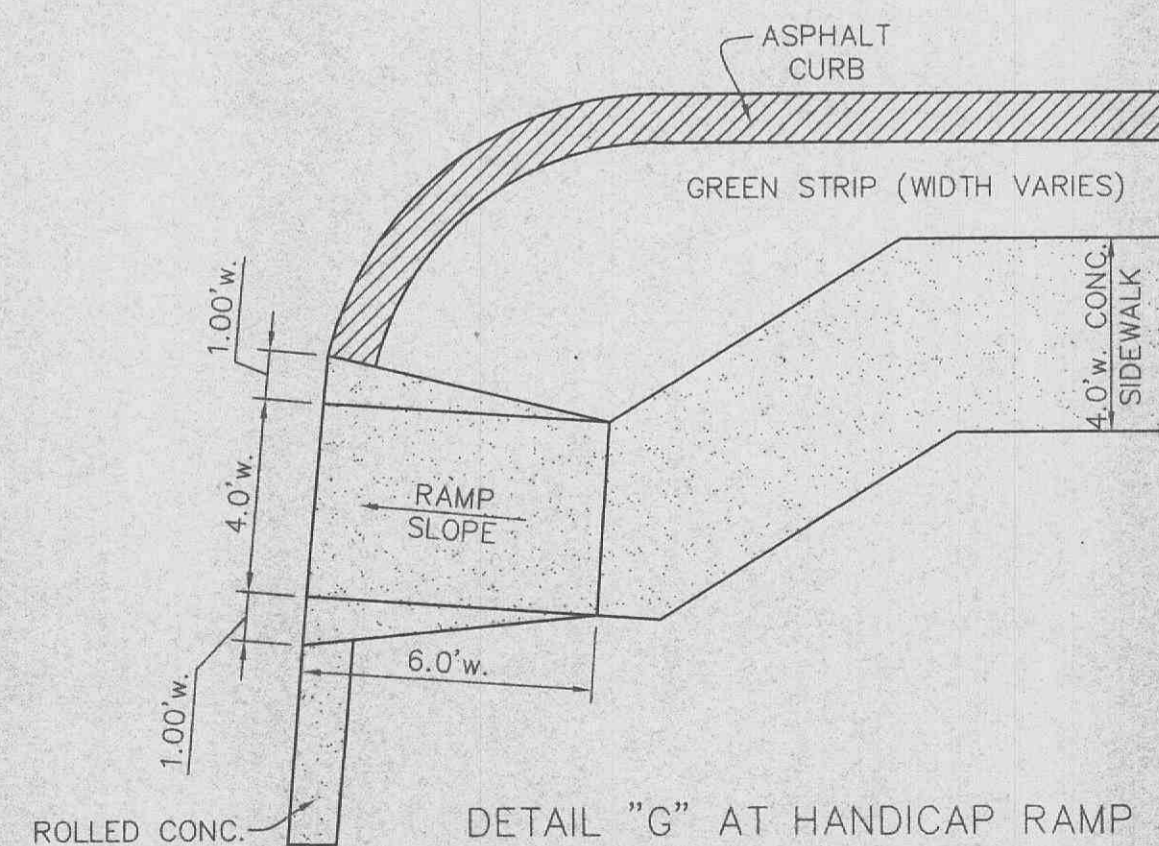

DETAIL "G" AT HANDICAP RAMP
NO SCALE

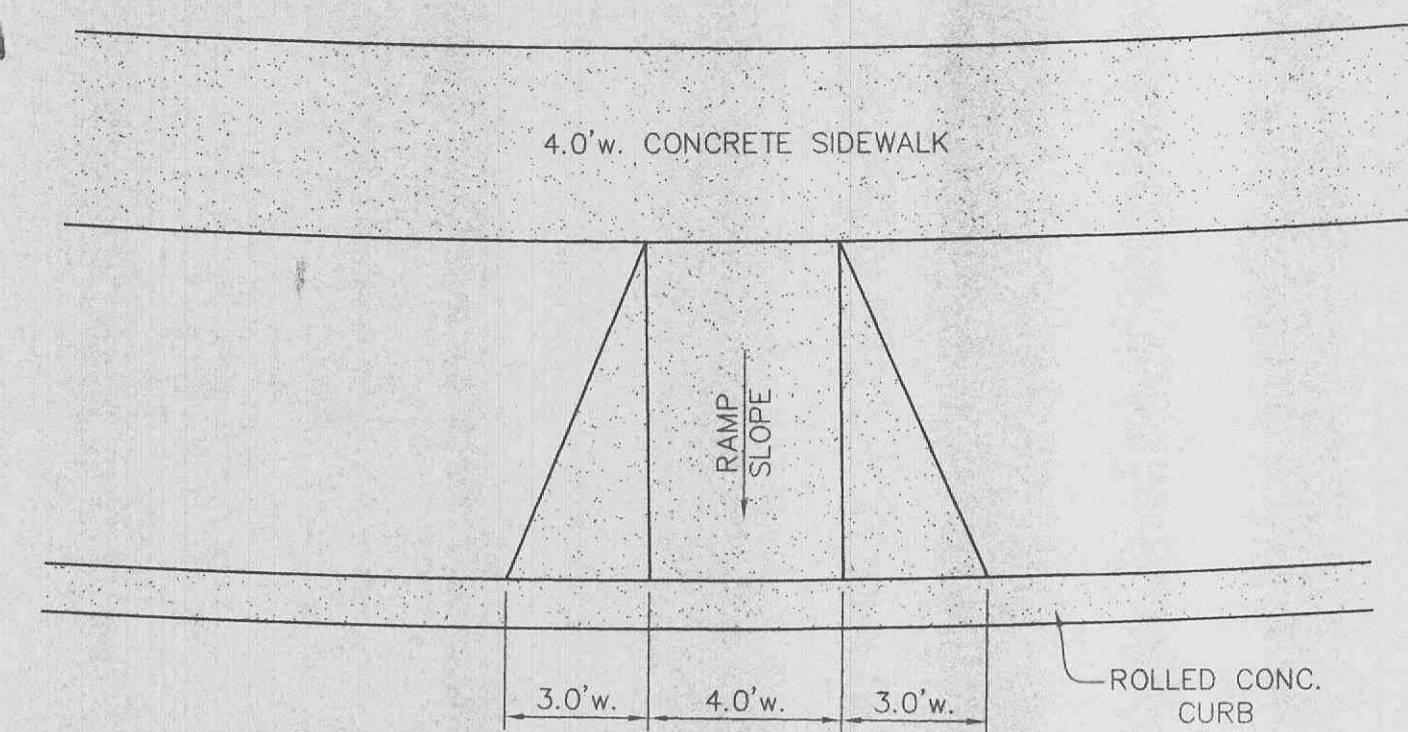

DETAIL "H" AT HANDICAP RAMP
NO SCALE

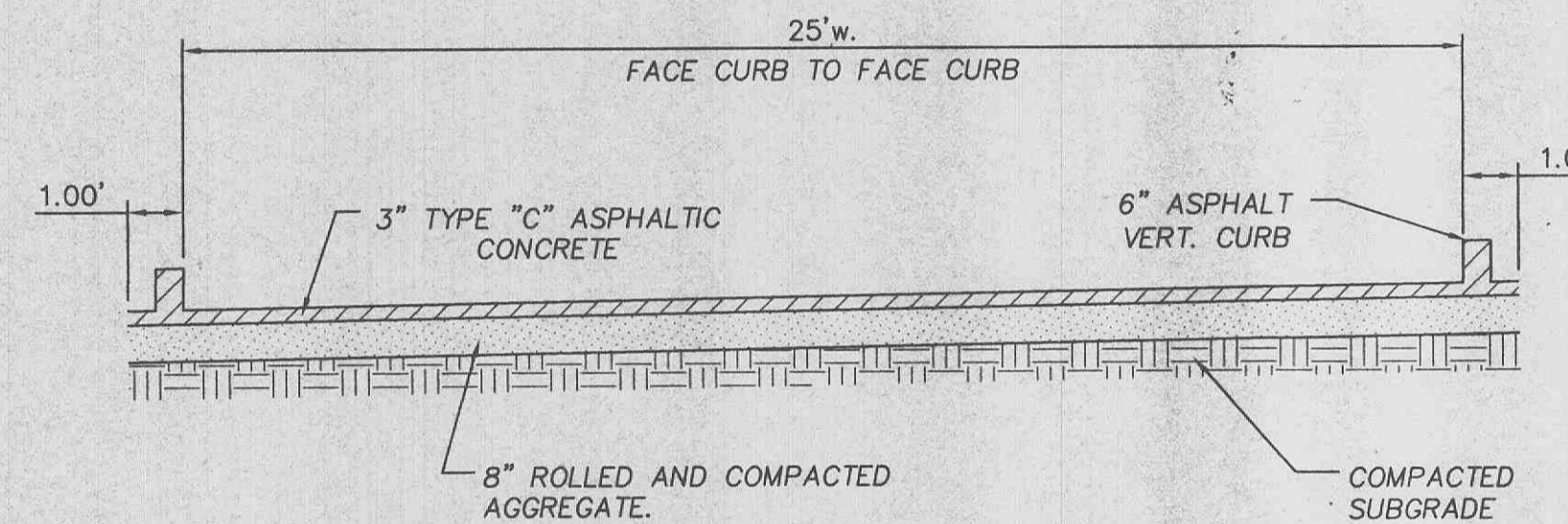

TYPICAL ROAD SECTION
N.T.S.

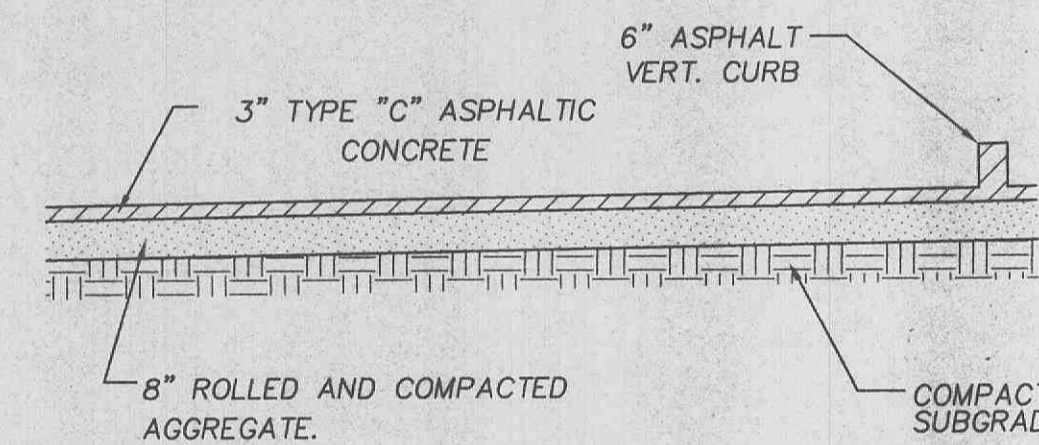

TYPICAL PARKING AREA SECTION
N.T.S.

NOTE: NO STEP AT ACCESSIBLE ENTRANCE DOORS.



HANDICAPPED IDENTIFICATION SIGN

THE UNDERGROUND UTILITIES SHOWN HEREON WERE PLOTTED FROM AVAILABLE INFORMATION AND DO NOT NECESSARILY REFLECT THE ACTUAL EXISTENCE, NONEXISTENCE, SIZE, TYPE, NUMBER OR LOCATION OF THESE OR OTHER UTILITIES. THE GENERAL CONTRACTOR SHALL BE RESPONSIBLE FOR VERIFYING THE ACTUAL LOCATION OF ALL UNDERGROUND UTILITIES, SHOWN OR NOT SHOWN, AND SAID UTILITIES SHALL BE LOCATED IN THE FIELD PRIOR TO ANY GRADING, EXCAVATION OR CONSTRUCTION OF IMPROVEMENTS. THESE PROVISIONS SHALL IN NO WAY ABSOLVE ANY PARTY FROM COMPLYING WITH THE UNDERGROUND FACILITY SAFETY AND DAMAGE PREVENTION ACT, CHAPTER 319, RSMo.

ISSUE/REMARKS/DATE
1 04/12/99 SUBMITTAL
2 05/04/99 REVISIONS PER CITY OF FALLON

PREPARED FOR:

J.M.B. MILL CREEK L.L.C.
5091 NEW BAUMGARTNER ROAD
ST. LOUIS, MISSOURI 63129
PHONE: (314) 487-6717

PREPARED BY:

5055 NEW BAUMGARTNER ROAD
ST. LOUIS, MISSOURI 63129
STERLING
ENGINEERS, SURVEYORS AND PLANNERS
(314) 487-0440, FAX 487-8844

DRAWN:

DESIGNED:

CHECKED:

PROJECT:

ESTATES/VILLAS
AT HIGHGROVE

NO. 98 02 036

M.S.D. SHEET 5 OF 6

P#

DIGITAL FILE LOCATION

REGION 2008R-DET

OF 6

SHEET TITLE: REC.-DETAIL SHEET

BASE MAP