

DUCKETT CREEK SANITARY DISTRICT
CREEK CROSSING
DETAIL
30A

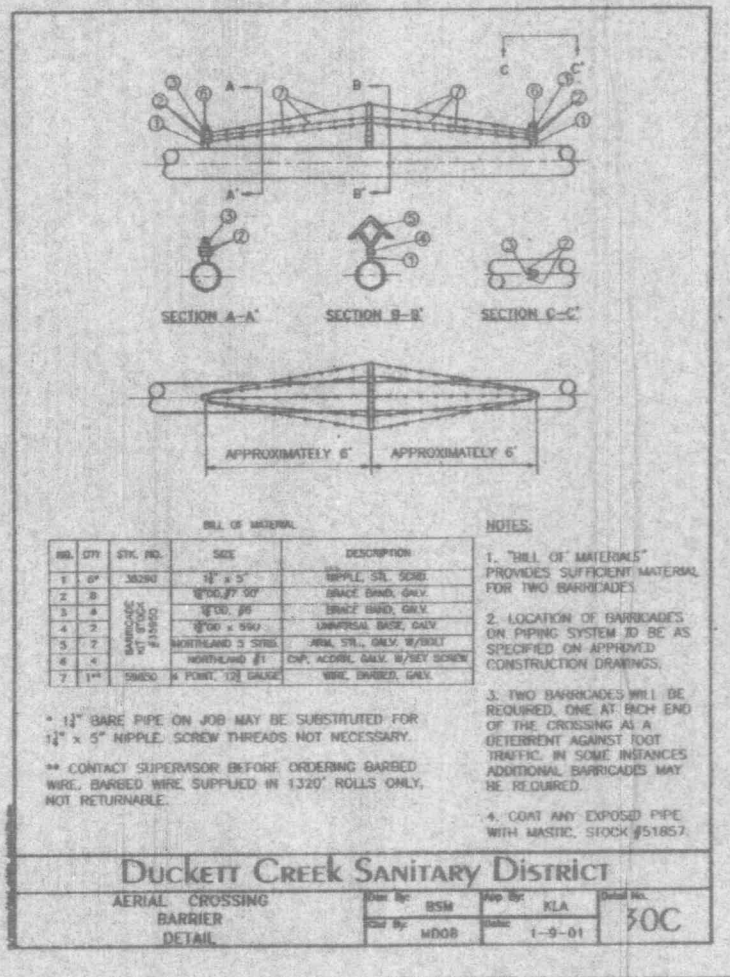

DUCKETT CREEK SANITARY DISTRICT
CREEK CROSSING
DETAIL
30C

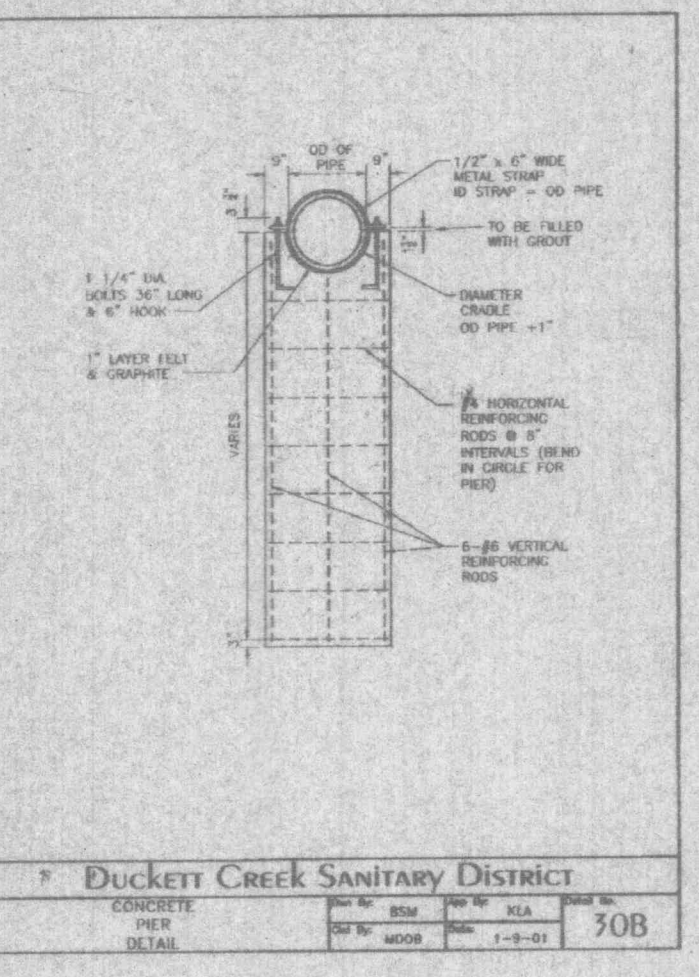
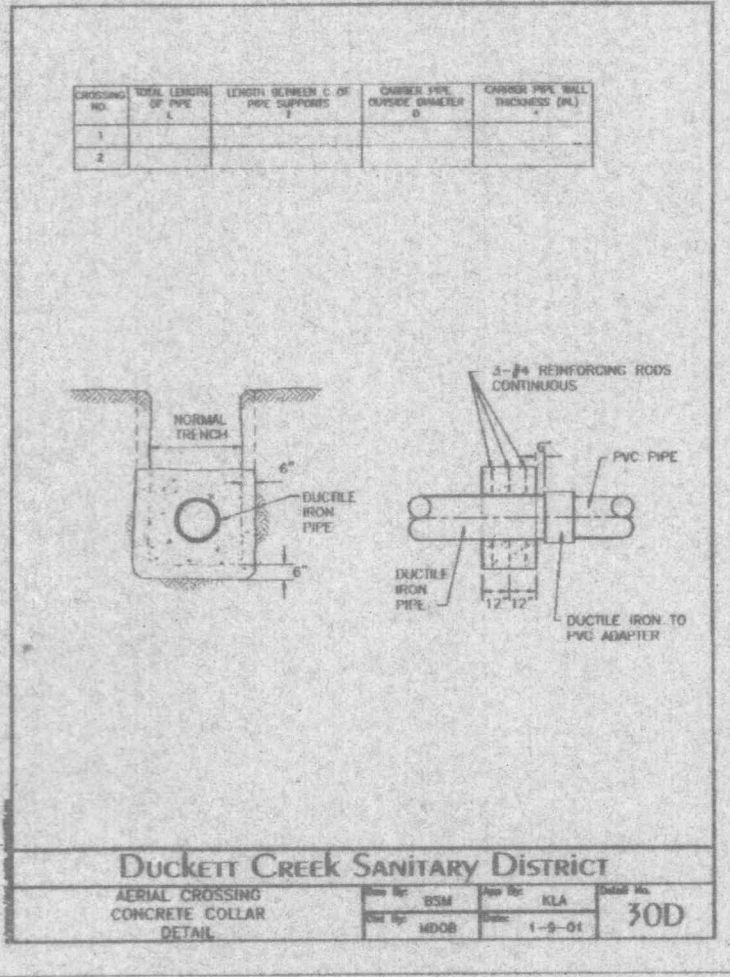

DUCKETT CREEK SANITARY DISTRICT
CREEK CROSSING
DETAIL
30D

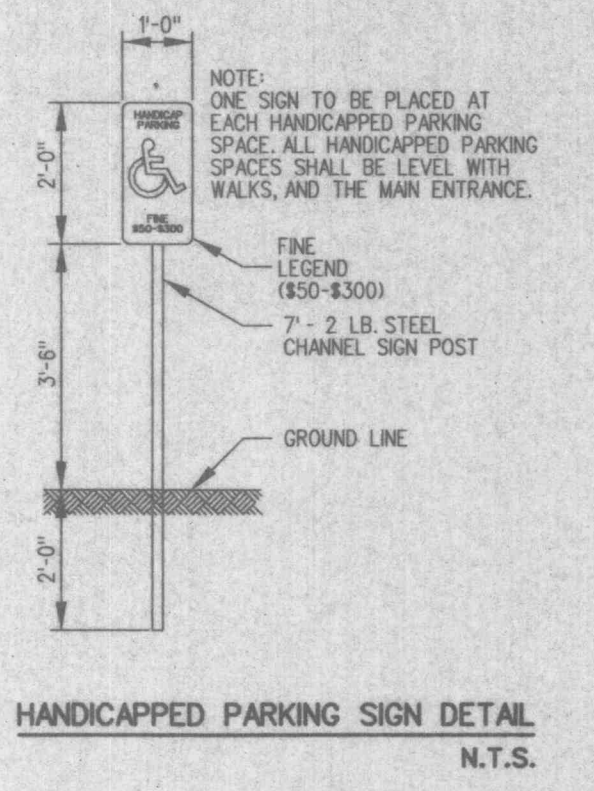

HANDICAPPED PARKING SIGN DETAIL
N.T.S.

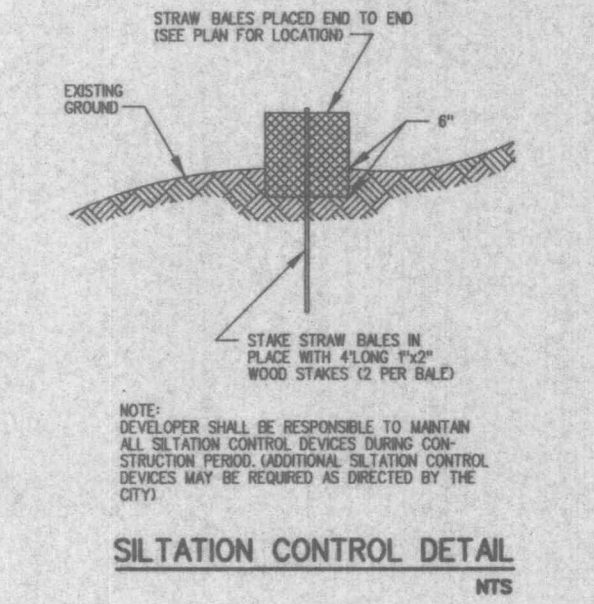

SILTATION CONTROL DETAIL
NTS

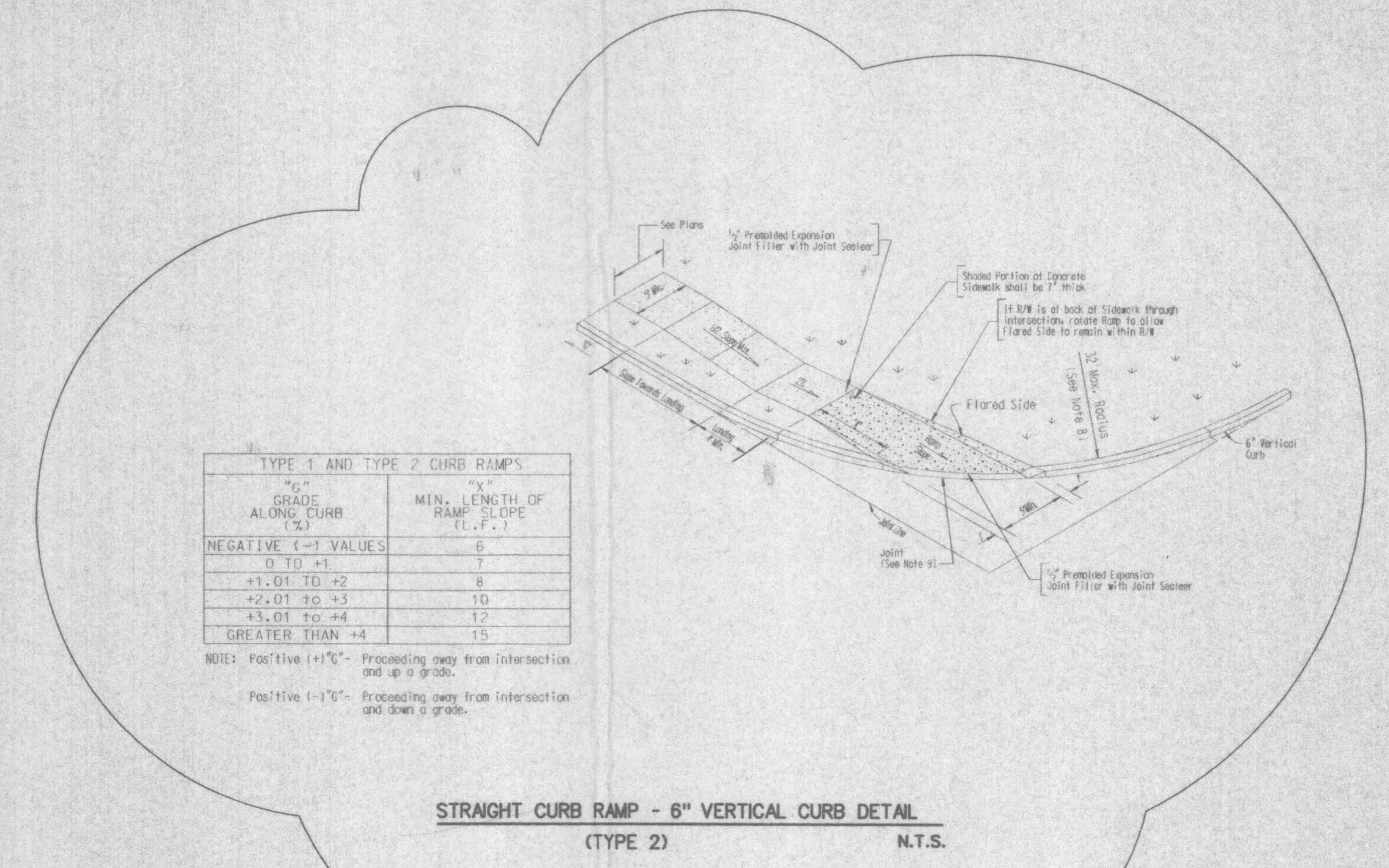

STRAIGHT CURB RAMP - 6" VERTICAL CURB DETAIL
(TYPE 2)
N.T.S.

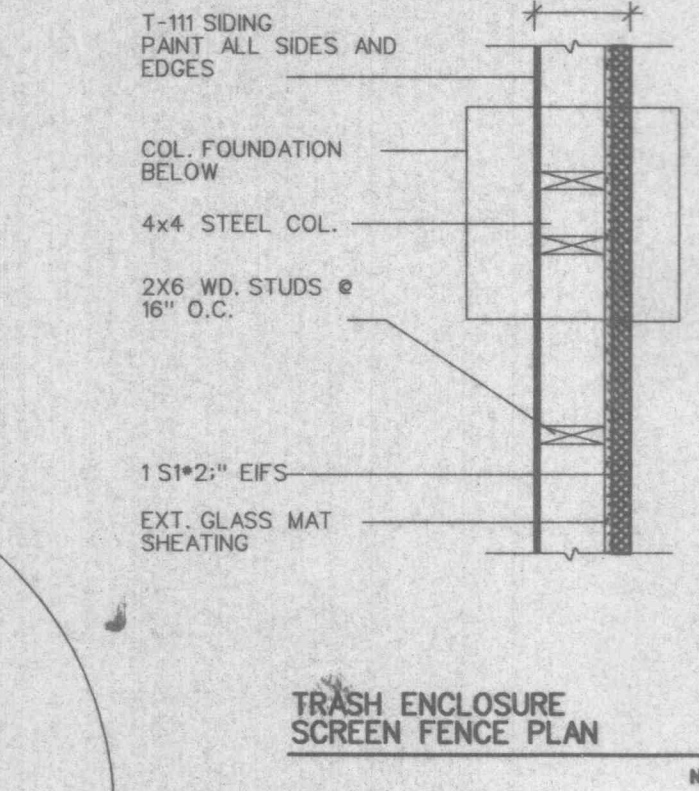

TRASH ENCLOSURE SCREEN FENCE PLAN
NTS

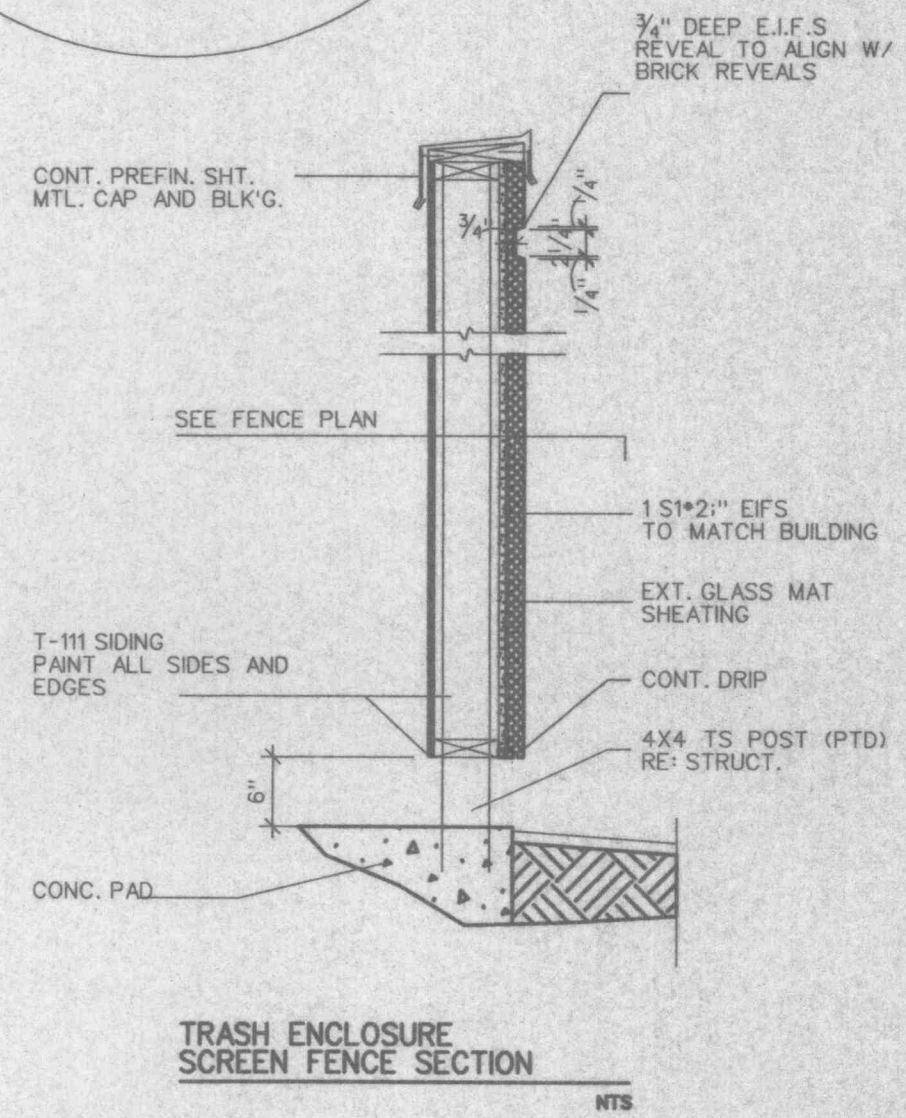

TRASH ENCLOSURE SCREEN FENCE SECTION
NTS

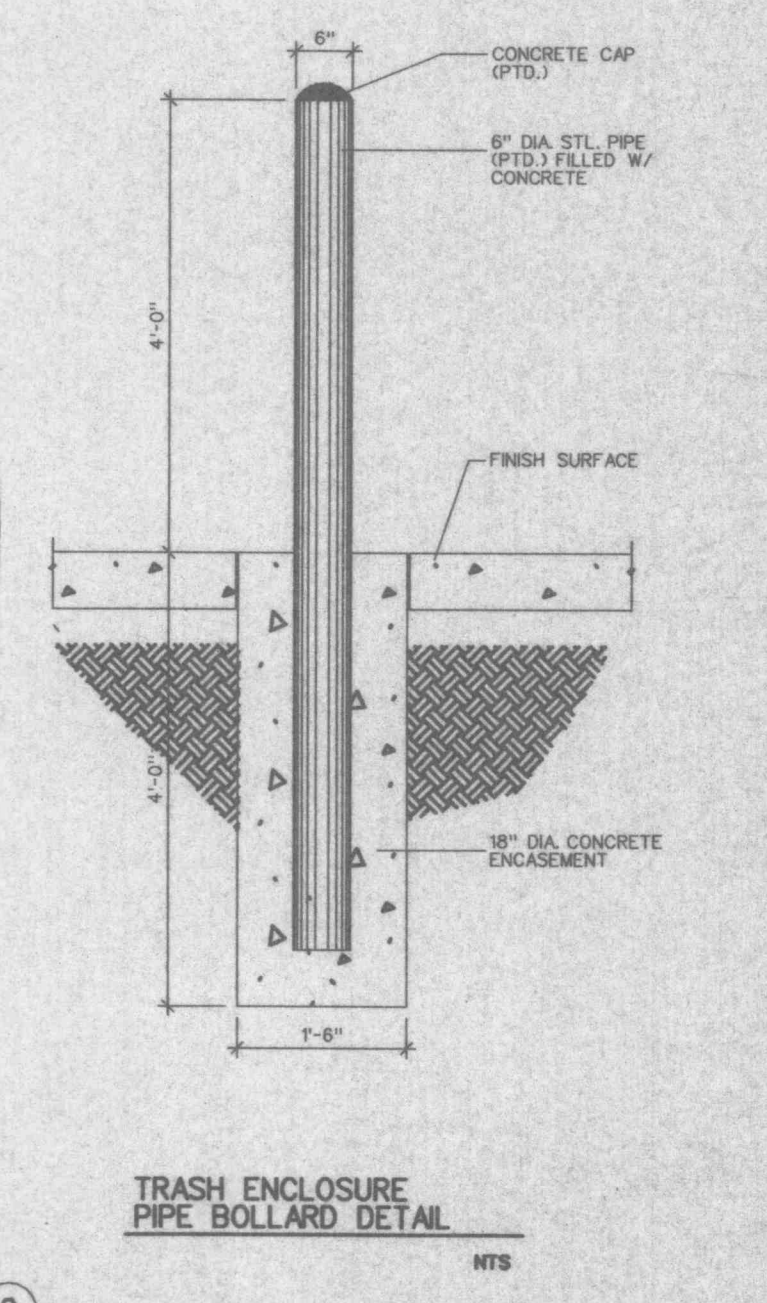

TRASH ENCLOSURE PIPE BOLLARD DETAIL
NTS

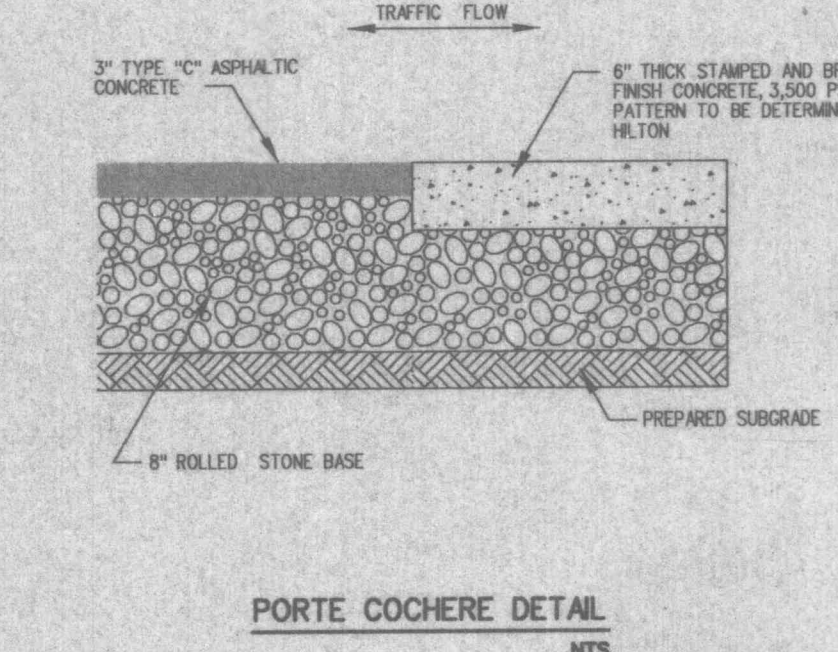

PORTE COCHERE DETAIL
NTS

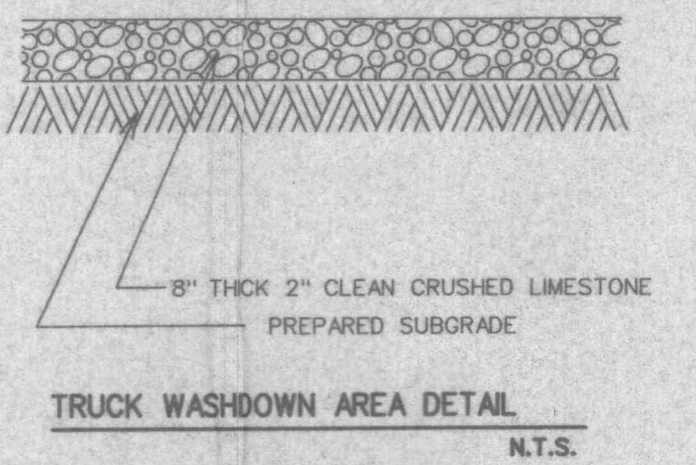

TRUCK WASHDOWN AREA DETAIL
N.T.S.

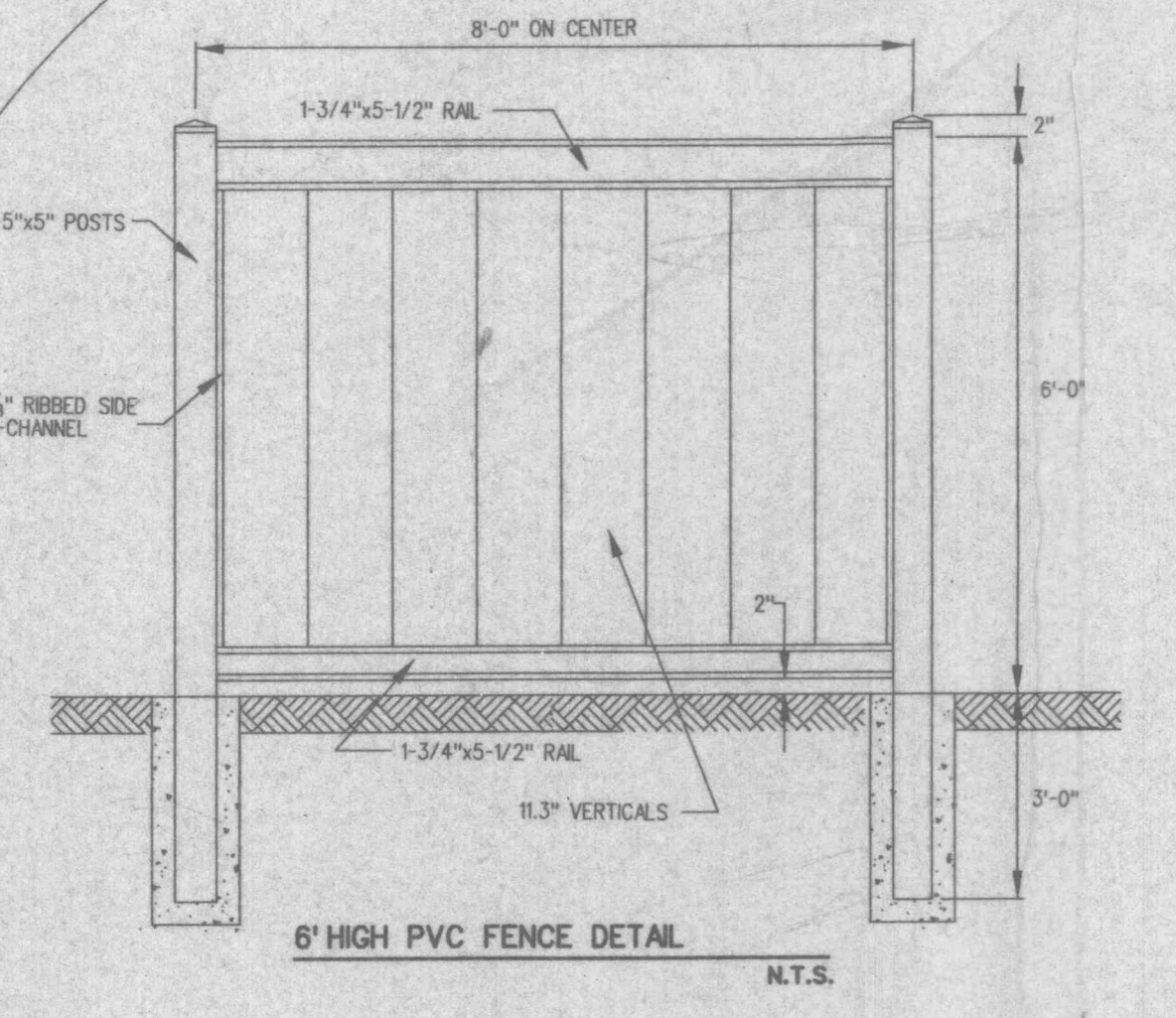

6" HIGH PVC FENCE DETAIL
N.T.S.

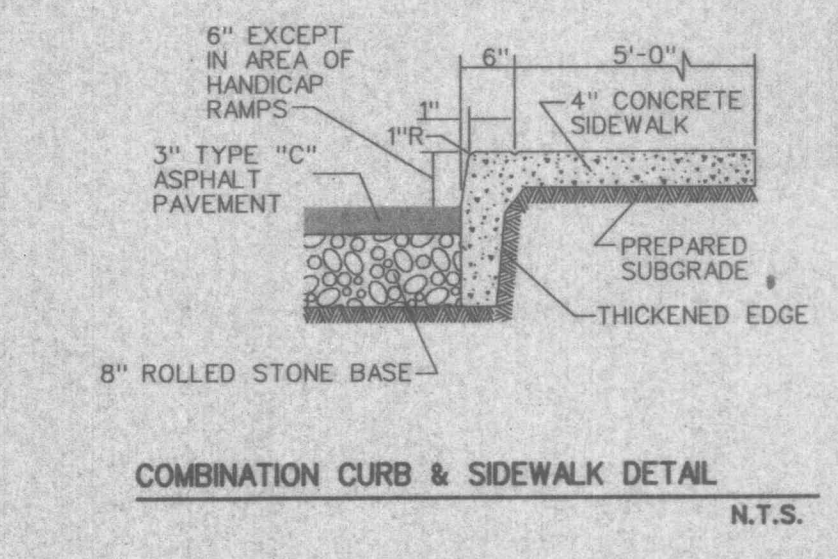

COMBINATION CURB & SIDEWALK DETAIL
N.T.S.

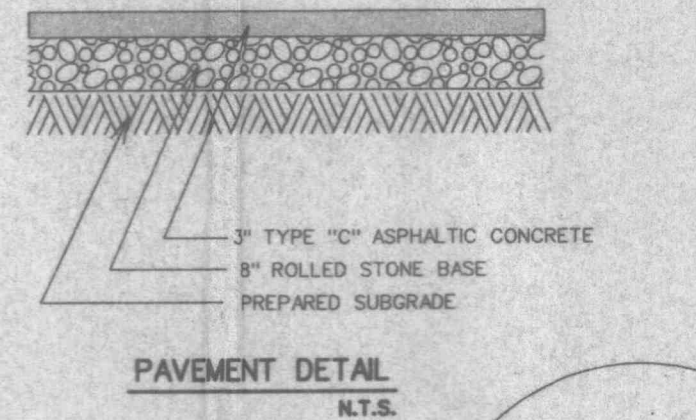

PAVEMENT DETAIL
N.T.S.

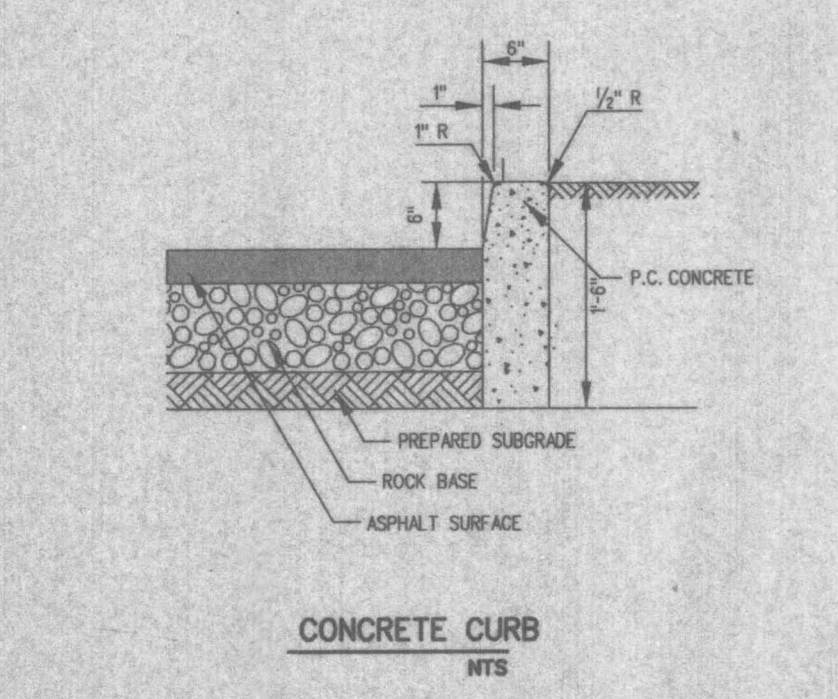

CONCRETE CURB
NTS

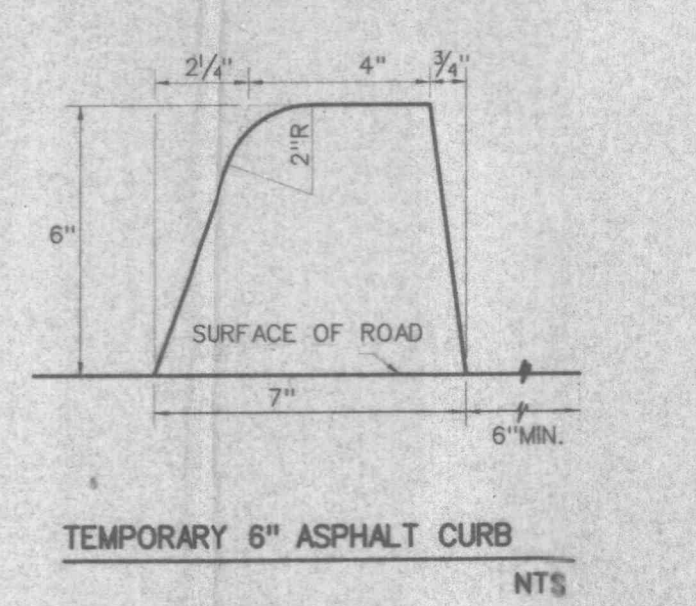

TEMPORARY 6" ASPHALT CURB
NTS

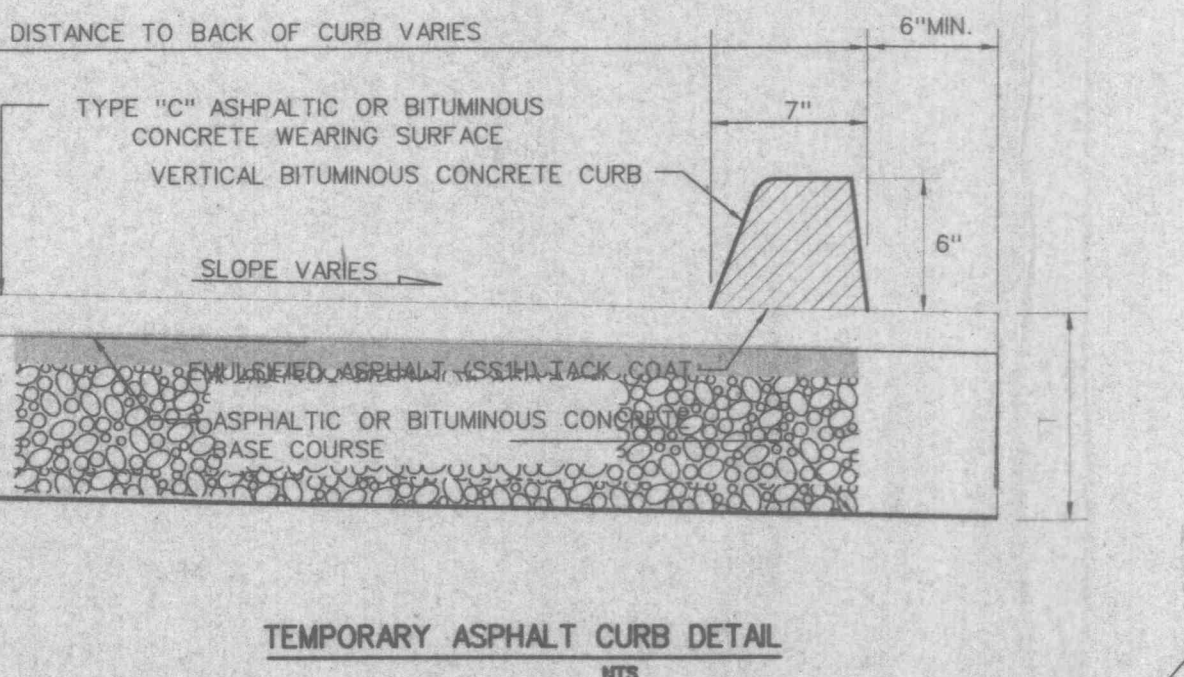

TEMPORARY ASPHALT CURB DETAIL
NTS

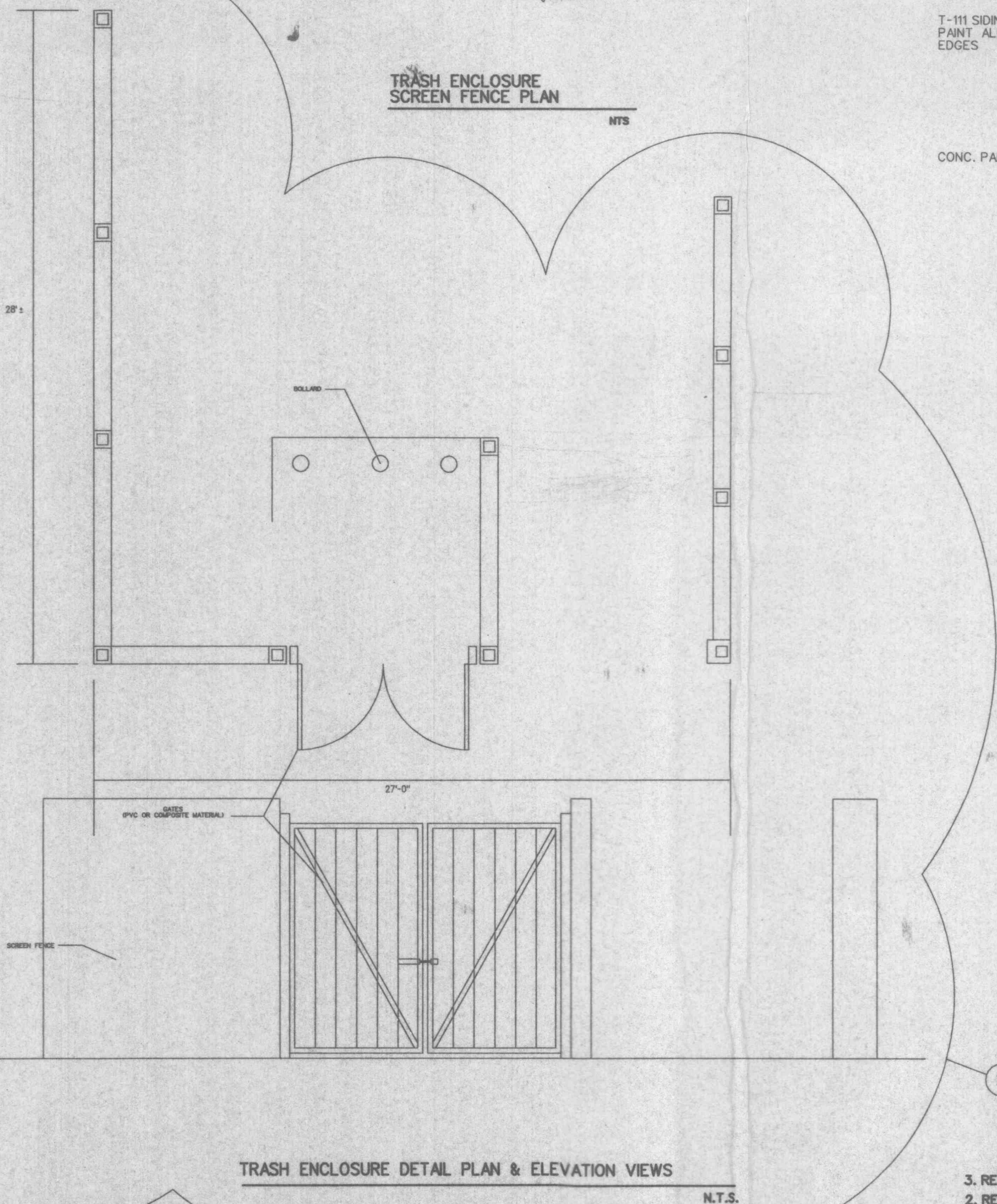

TRASH ENCLOSURE DETAIL PLAN & ELEVATION VIEWS
N.T.S.

3. REVISED: 05-29-02 City Ramp Detail, Relocated Details
2. REVISED: 05-13-02 City Temporary Curb Detail, Trash Enclosure Plan & Elevation, 6" PVC Privacy Fence Detail
1. REVISED: 03-13-02 Relocated Details, City Comments (JAF)

McEagle Development
688 CRAIG ROAD
ST. LOUIS, MISSOURI 63101
TEL: (314) 433-4300
FAX: (314) 433-4601

WOLZ
JOHN A. FERRELL
REGISTERED PROFESSIONAL ENGINEER
STATE OF MISSOURI
NUMBER E-1030
EXPIRES 12/31/02

HILTON AT WINGHAVEN

CONSTRUCTION DETAILS
Design By: JAF
Drawn By: JMS/JAF
Checked By: JAF
BS930-22
03/13/02
07