

ROUND PIPE		HORIZONTAL ELLIPTICAL PIPE	
PIPE DIAMETER (INCHES)	PAVING WIDTH (FEET)	PAVING WIDTH (FEET)	PAVING WIDTH (FEET)
4	3.50	3.50	3.50
6	3.50	3.50	3.50
8	3.50	3.50	3.50
10	3.50	3.50	3.50
12	3.50	3.50	3.50
15	3.50	3.50	3.50
18	3.50	3.50	3.50
21	3.50	3.50	3.50
24	3.50	3.50	3.50
27	3.50	3.50	3.50
30	3.50	3.50	3.50
33	3.50	3.50	3.50
36	3.50	3.50	3.50
39	3.50	3.50	3.50
42	3.50	3.50	3.50
45	3.50	3.50	3.50
48	3.50	3.50	3.50
51	3.50	3.50	3.50
54	3.50	3.50	3.50
57	3.50	3.50	3.50
60	3.50	3.50	3.50
63	3.50	3.50	3.50
66	3.50	3.50	3.50
69	3.50	3.50	3.50
72	3.50	3.50	3.50
75	3.50	3.50	3.50
78	3.50	3.50	3.50
81	3.50	3.50	3.50
84	3.50	3.50	3.50
87	3.50	3.50	3.50
90	3.50	3.50	3.50
93	3.50	3.50	3.50
96	3.50	3.50	3.50
99	3.50	3.50	3.50
102	3.50	3.50	3.50
105	3.50	3.50	3.50
108	3.50	3.50	3.50
111	3.50	3.50	3.50
114	3.50	3.50	3.50
117	3.50	3.50	3.50
120	3.50	3.50	3.50
123	3.50	3.50	3.50
126	3.50	3.50	3.50
129	3.50	3.50	3.50
132	3.50	3.50	3.50
135	3.50	3.50	3.50
138	3.50	3.50	3.50
141	3.50	3.50	3.50
144	3.50	3.50	3.50
147	3.50	3.50	3.50
150	3.50	3.50	3.50

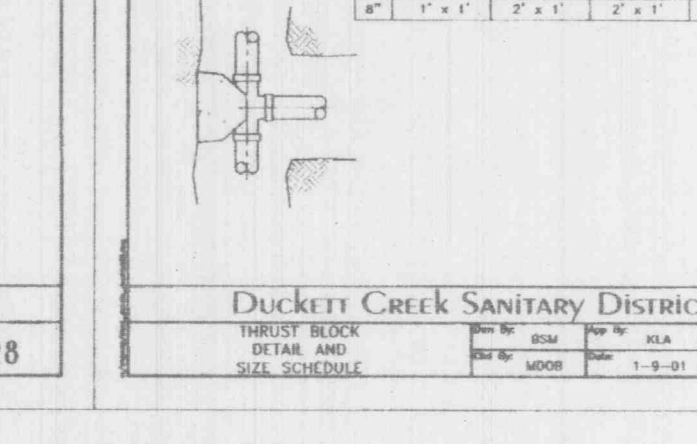
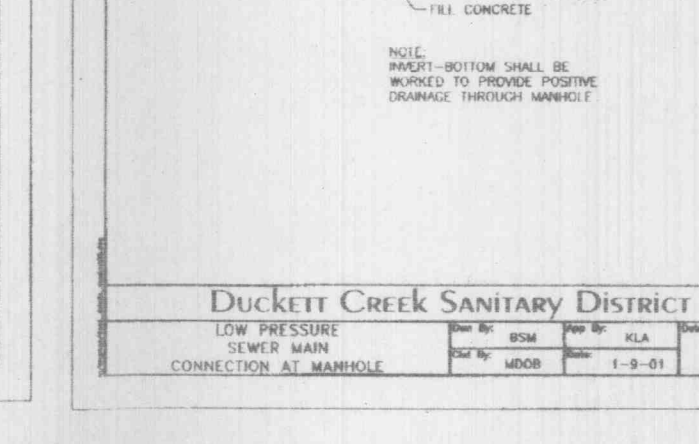
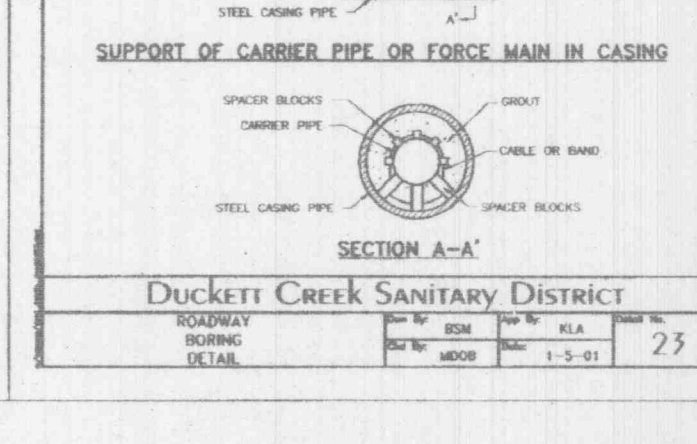
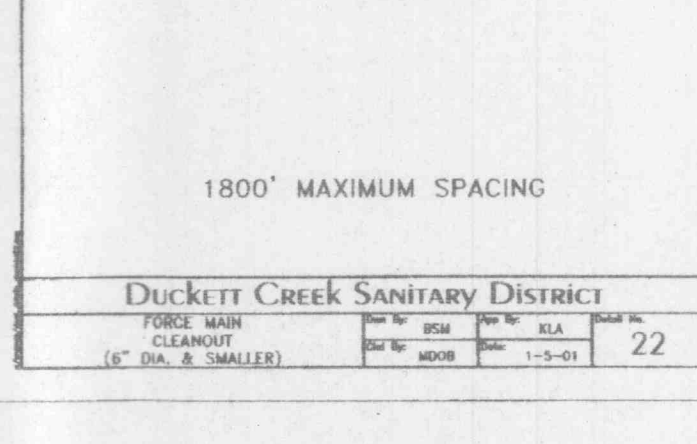
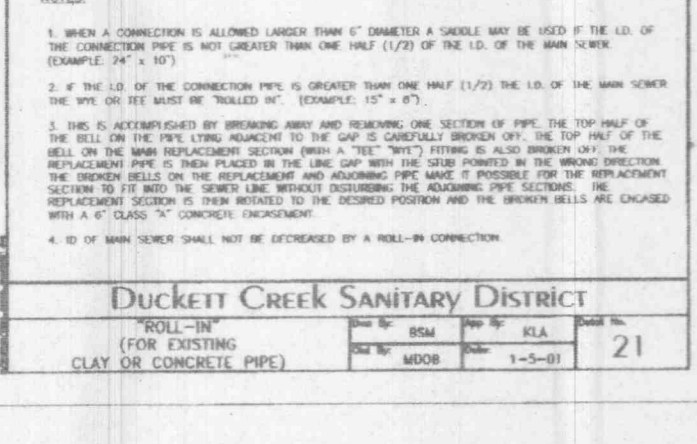
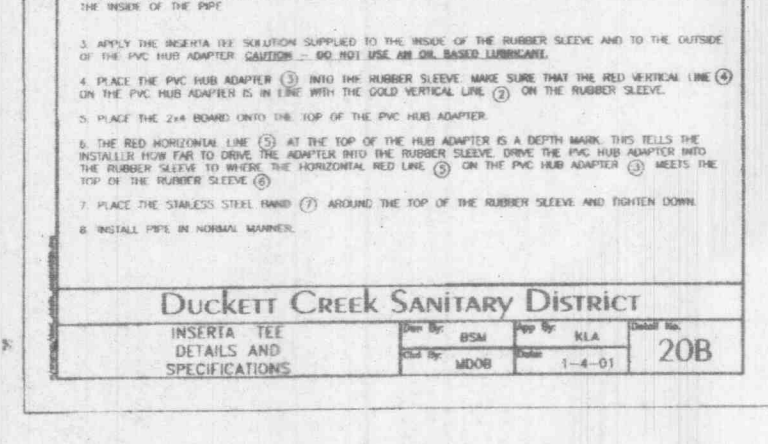
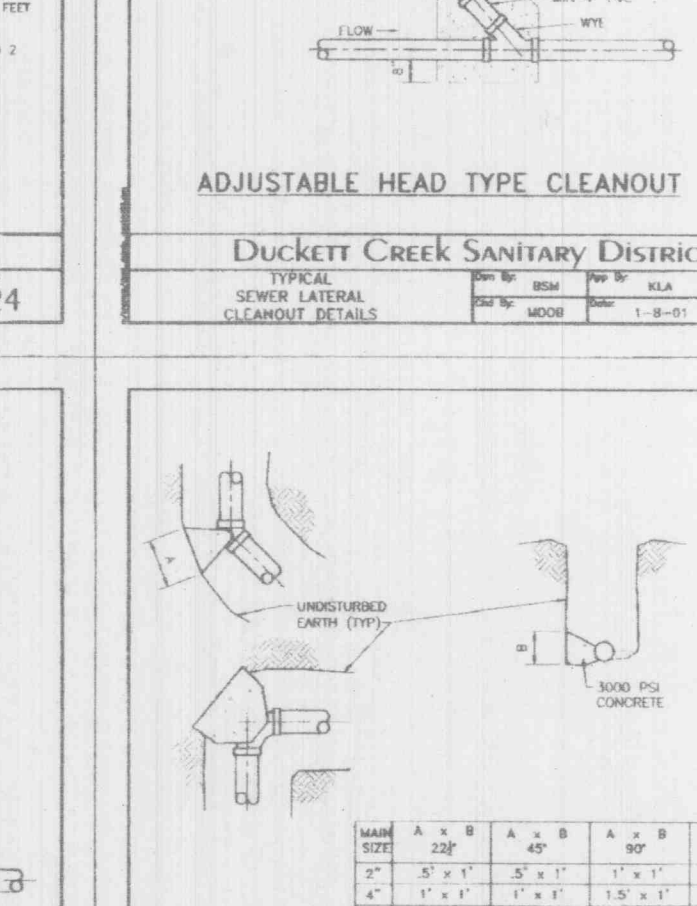
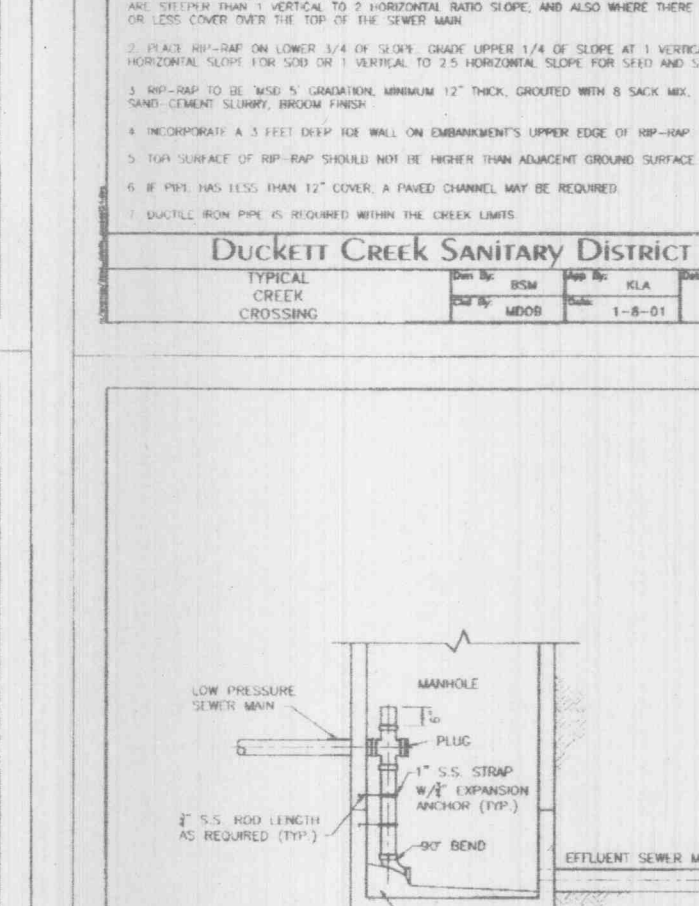
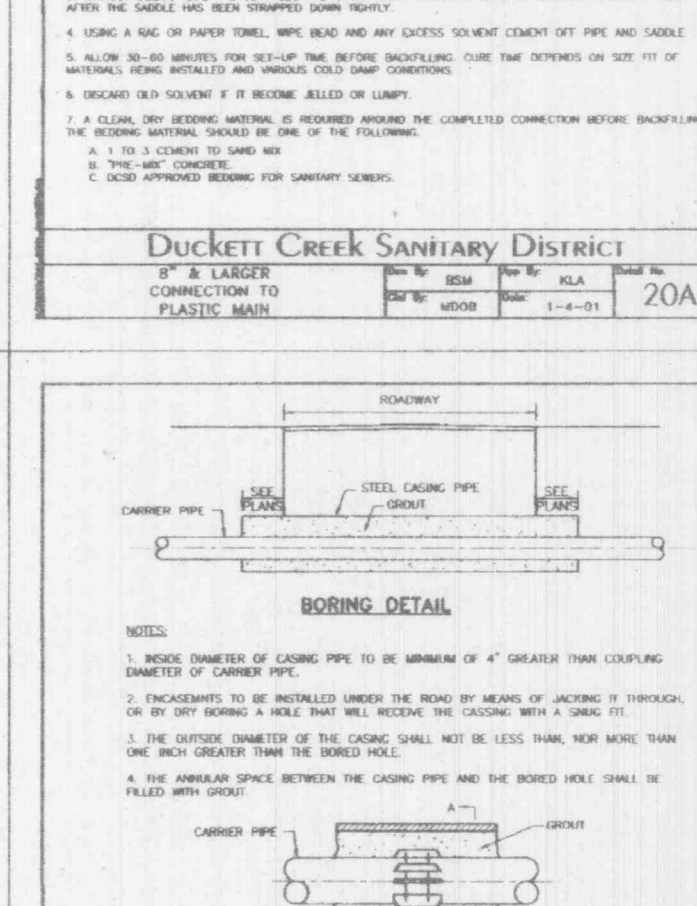
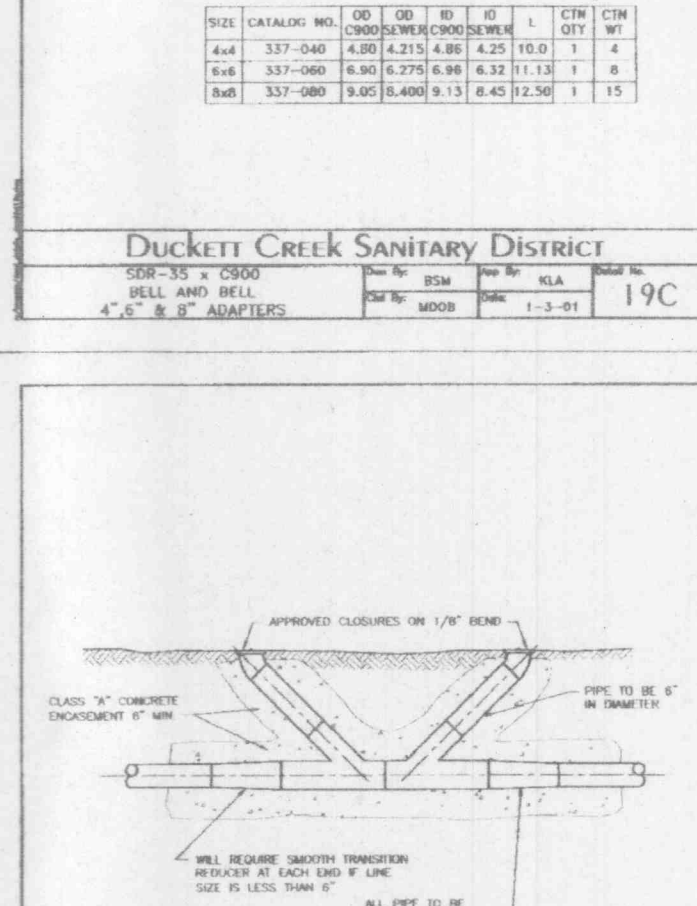
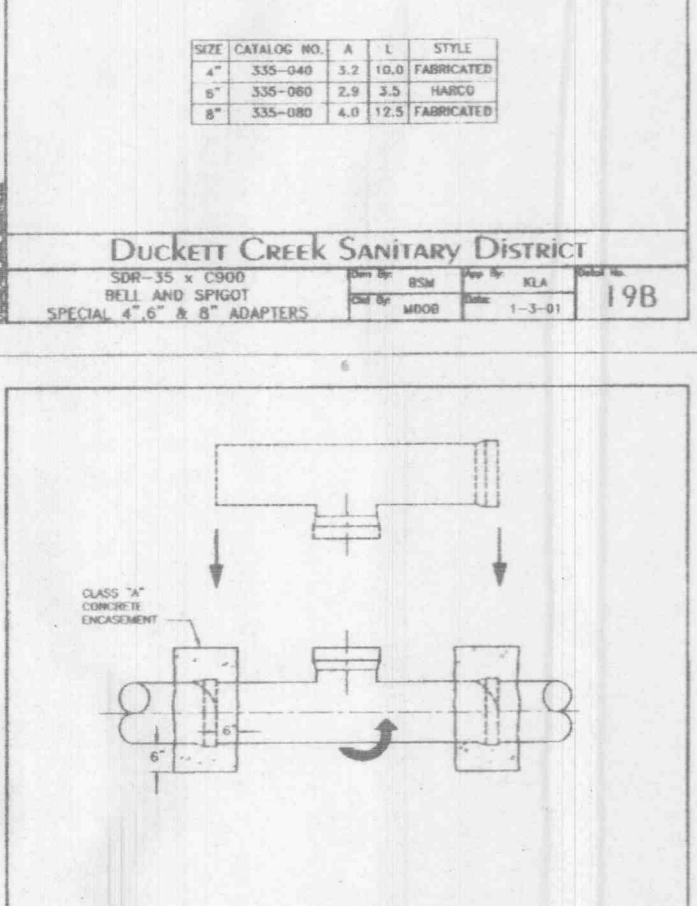
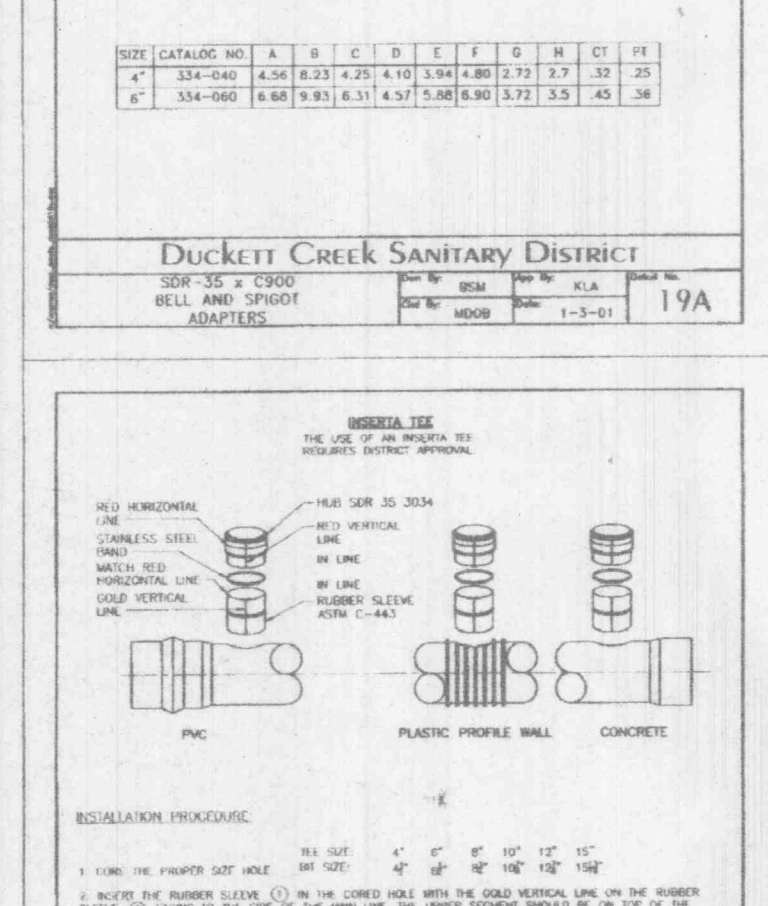
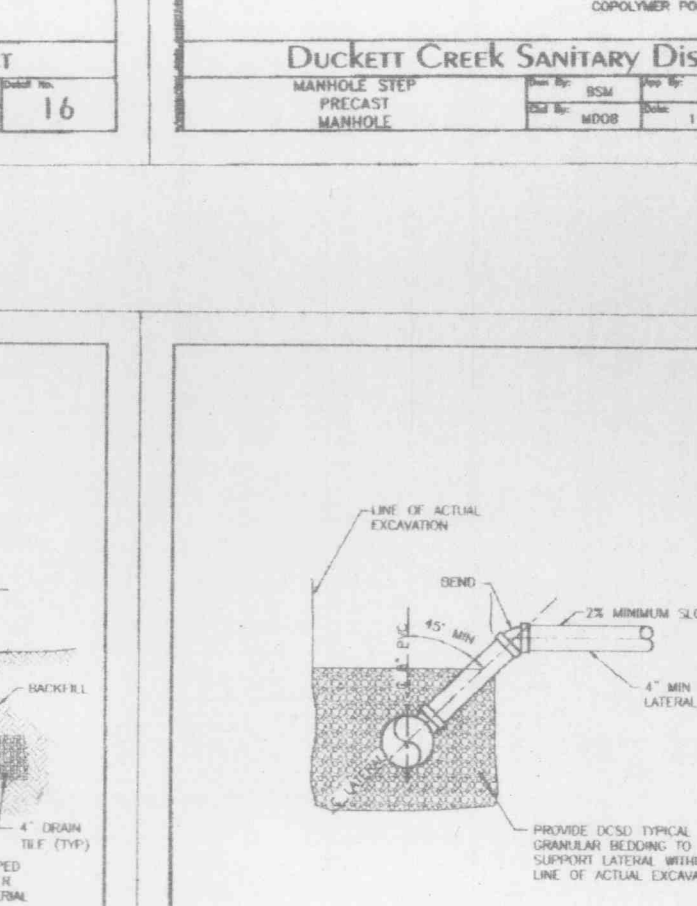
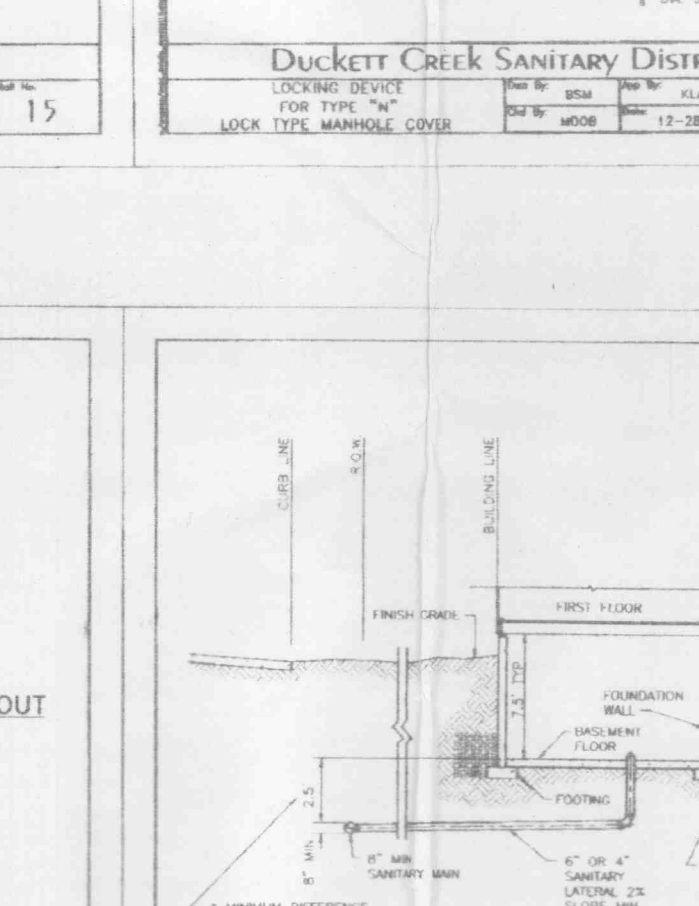
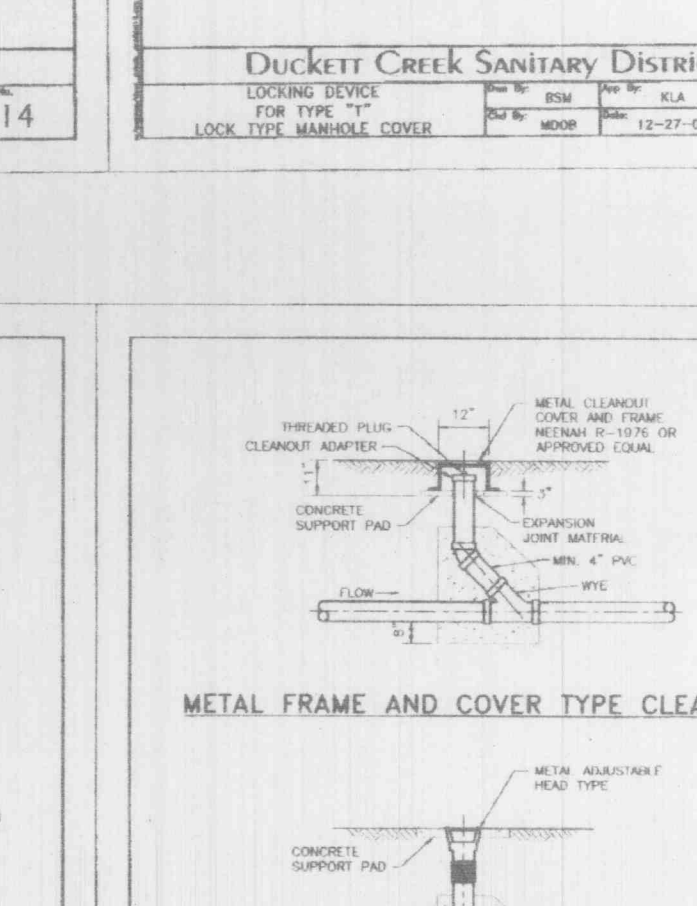
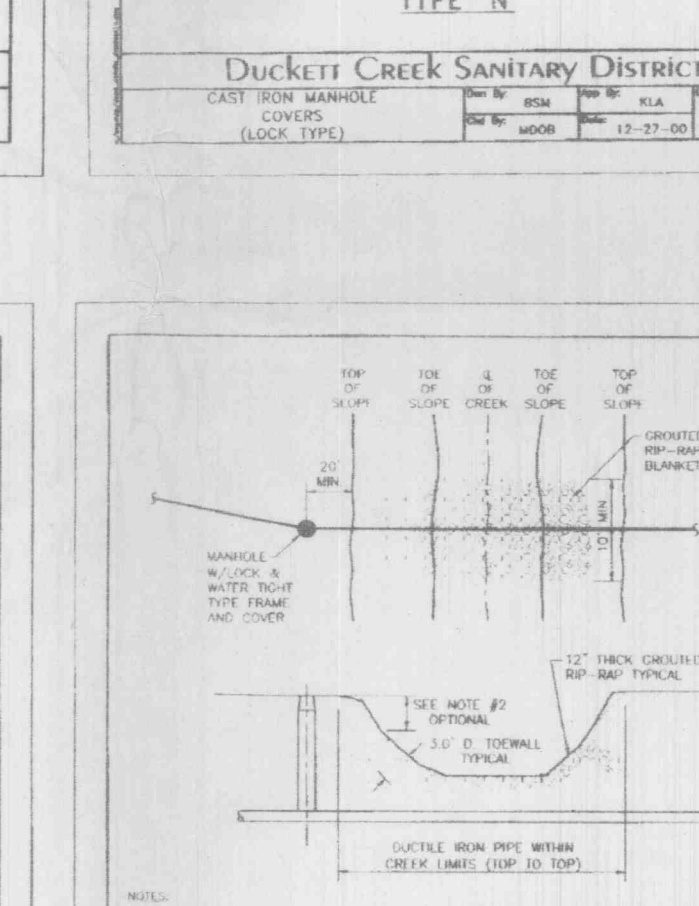
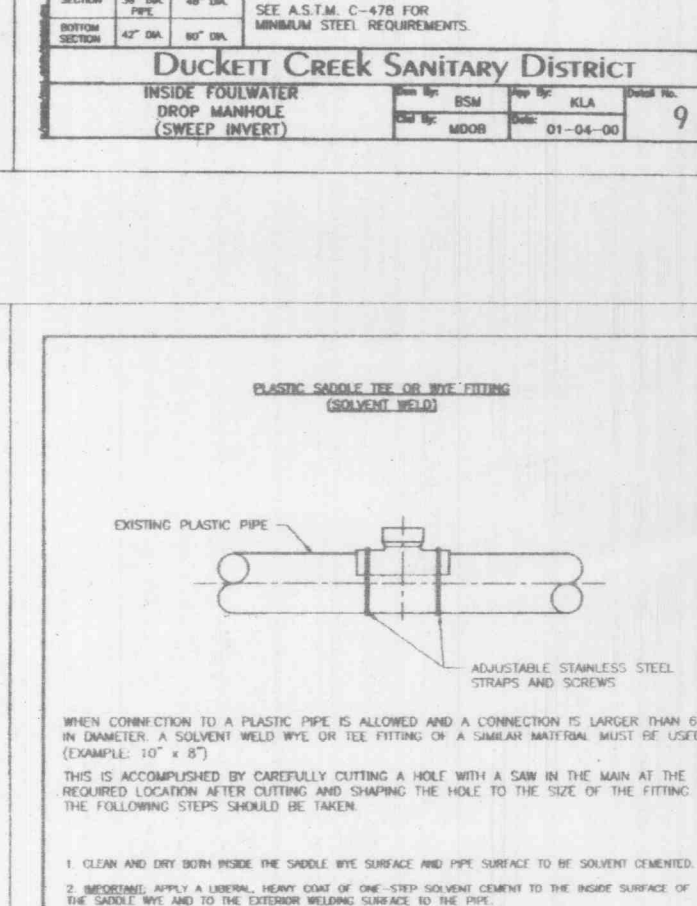
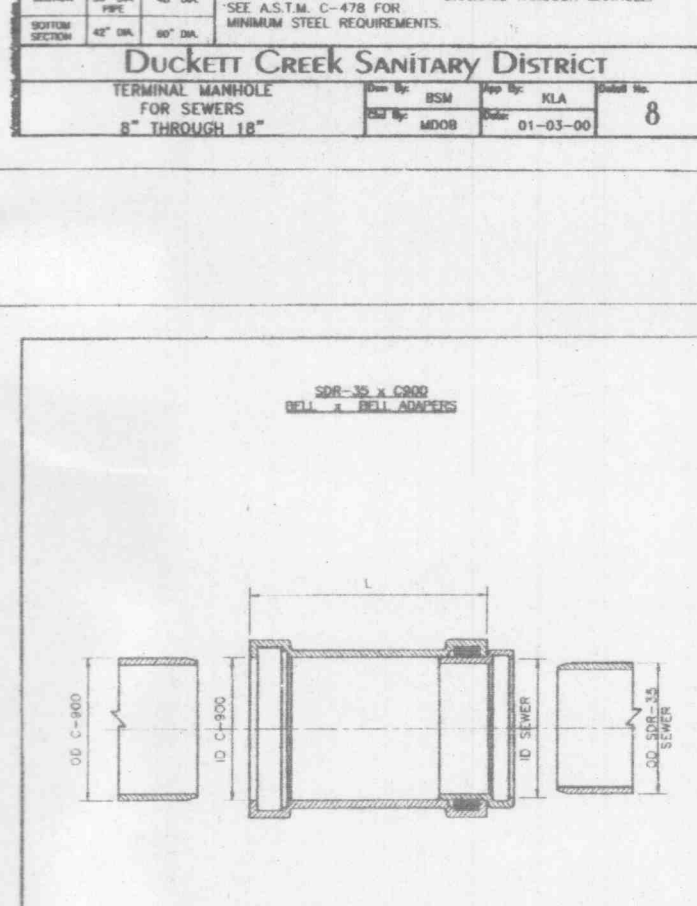
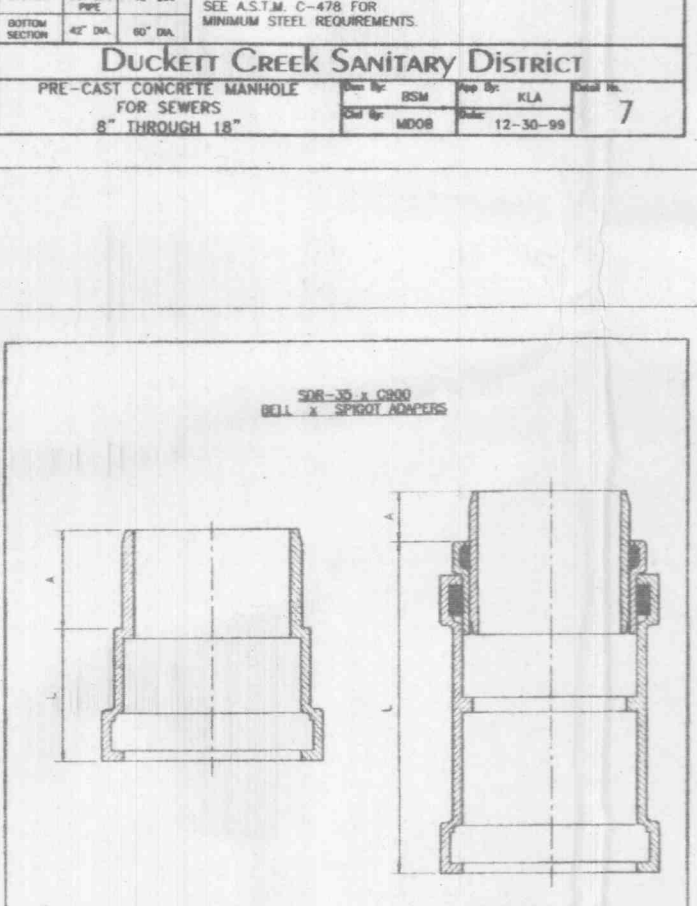
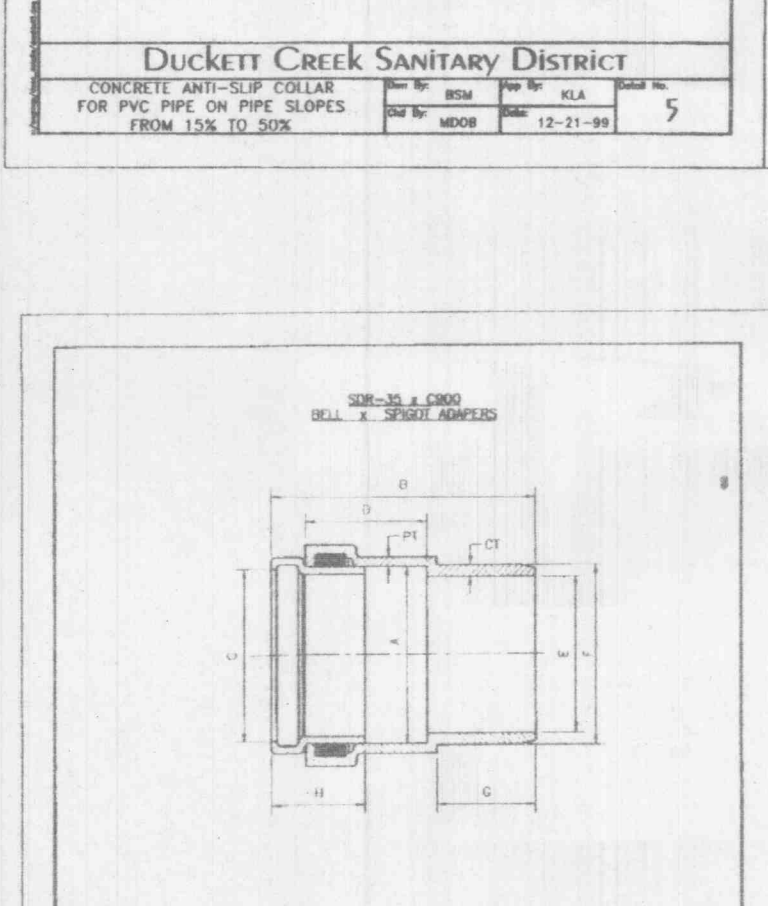
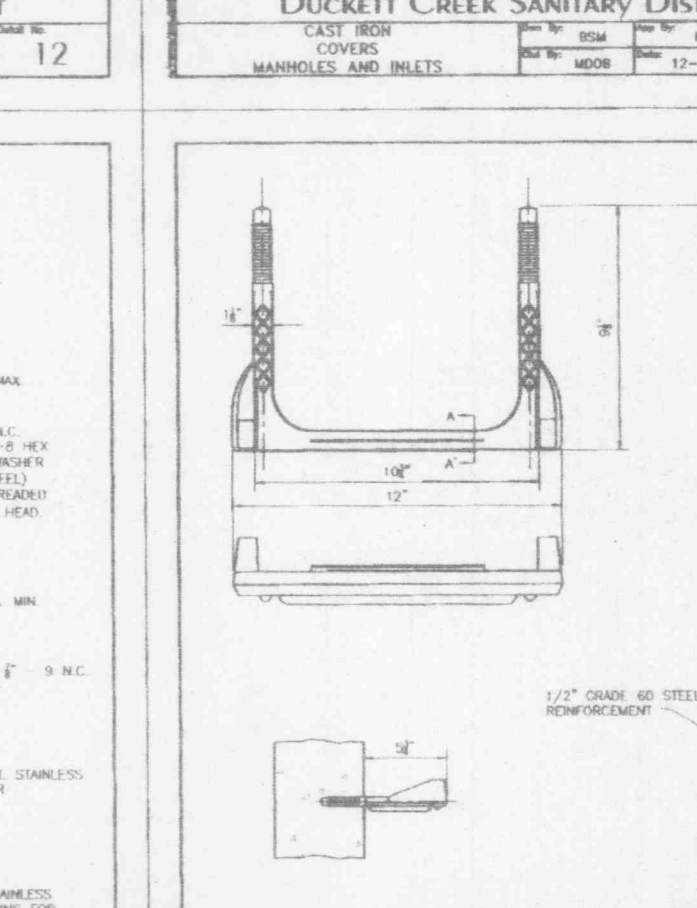
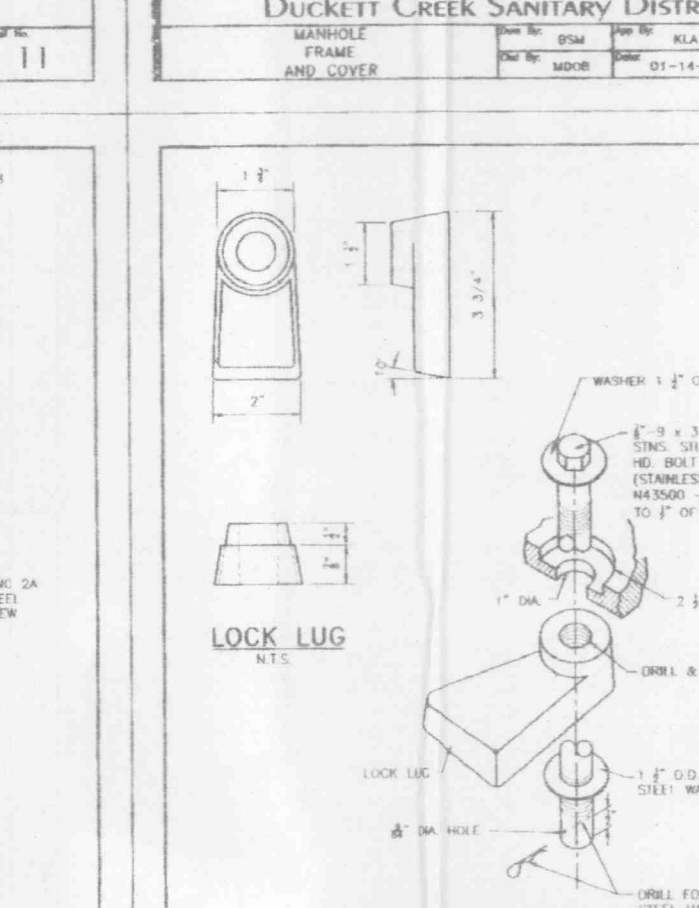
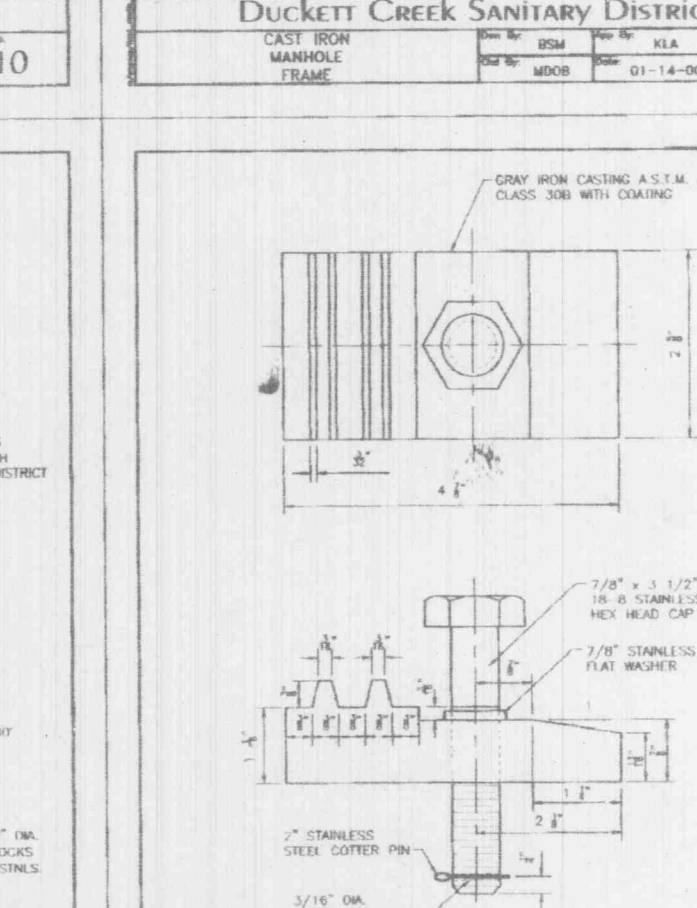
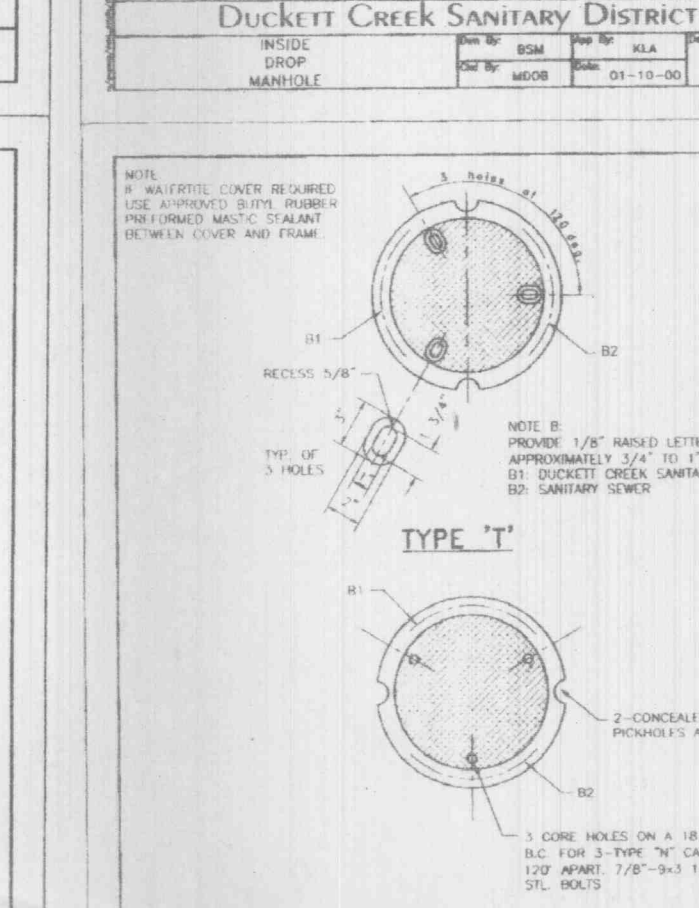
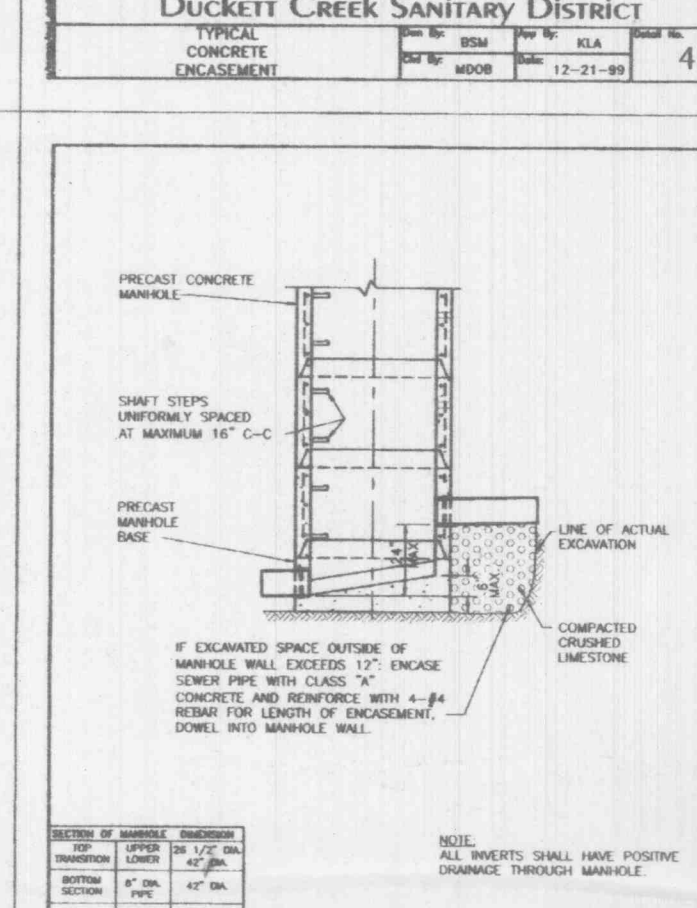
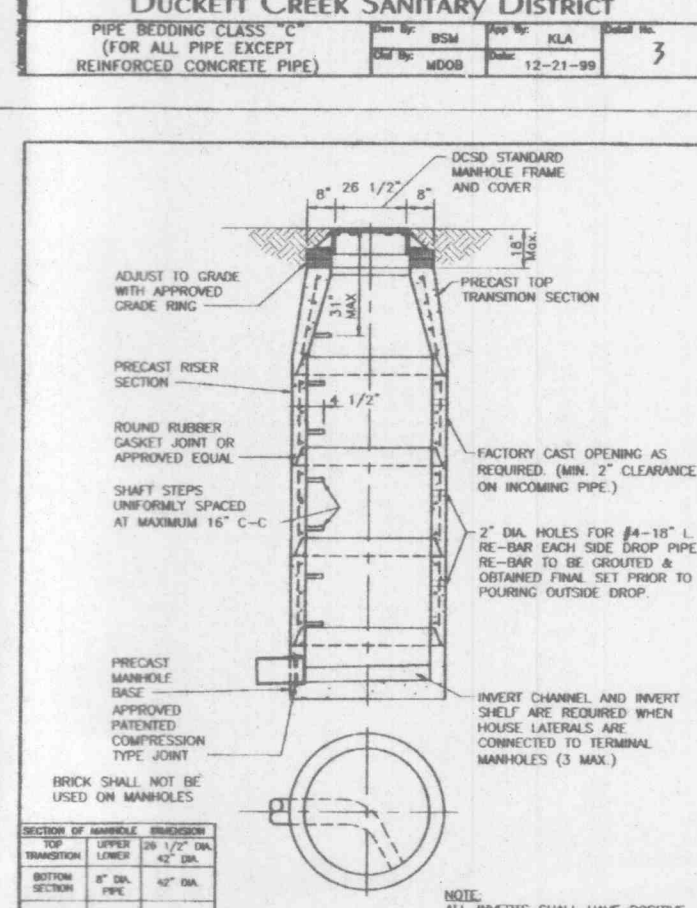
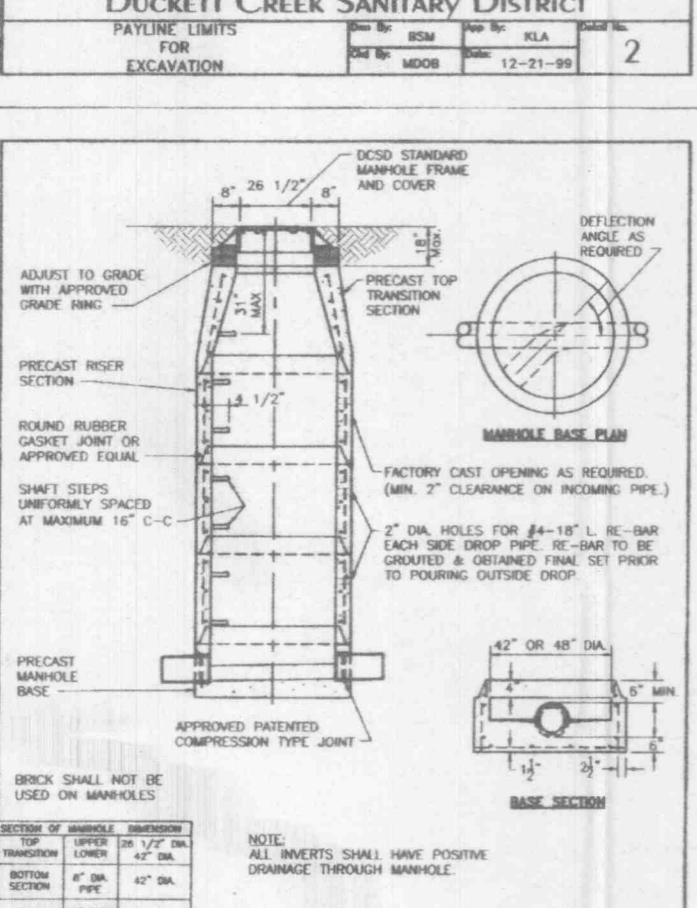
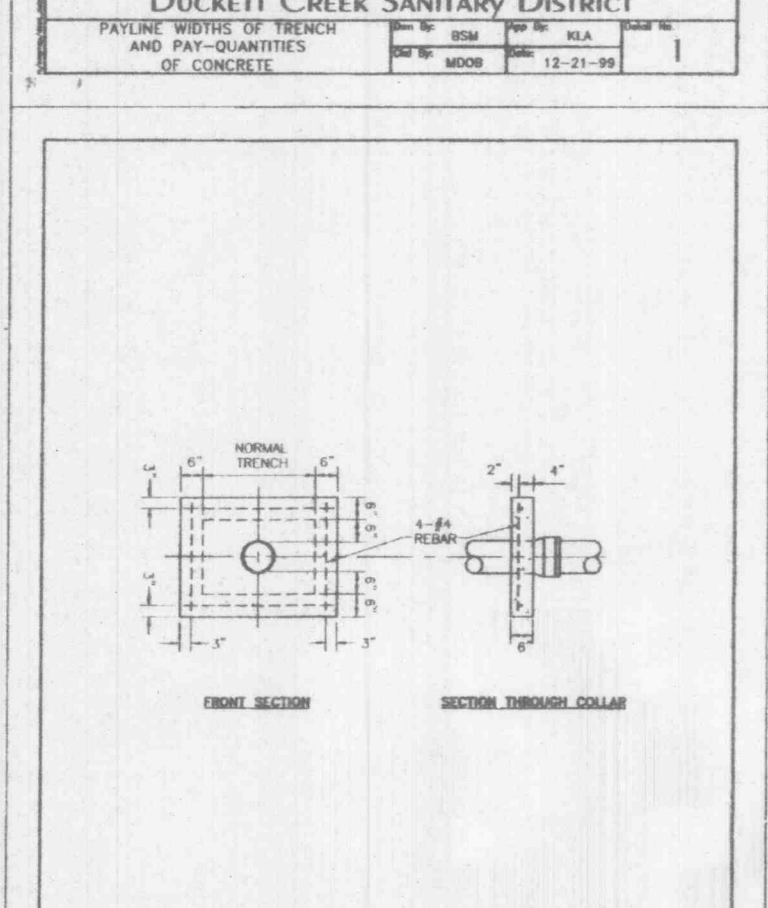
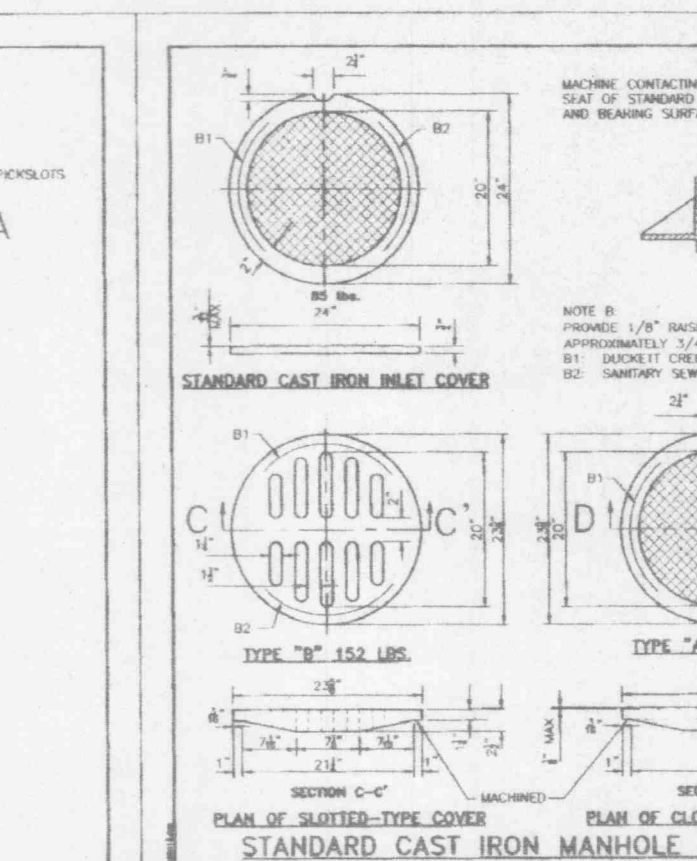
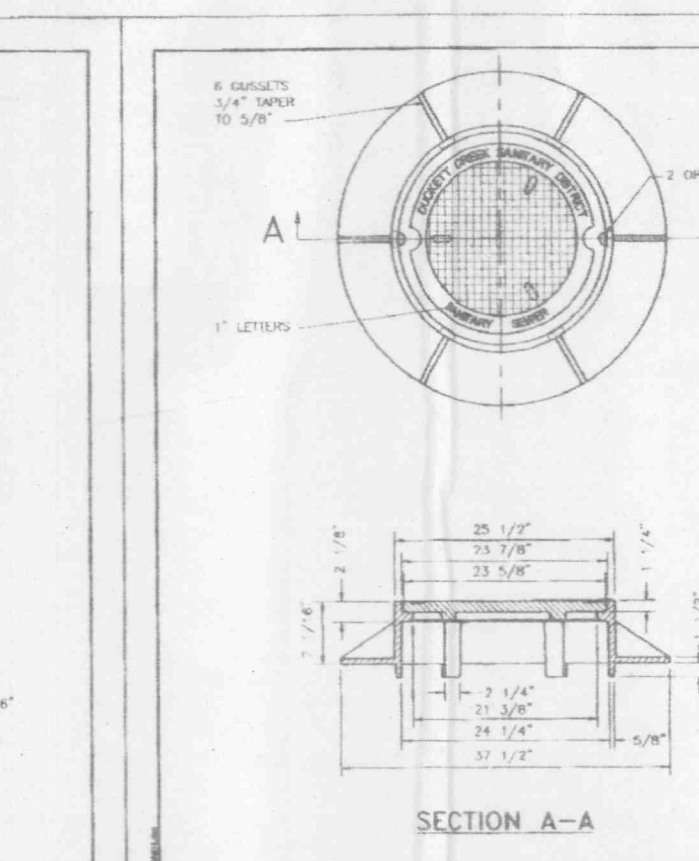
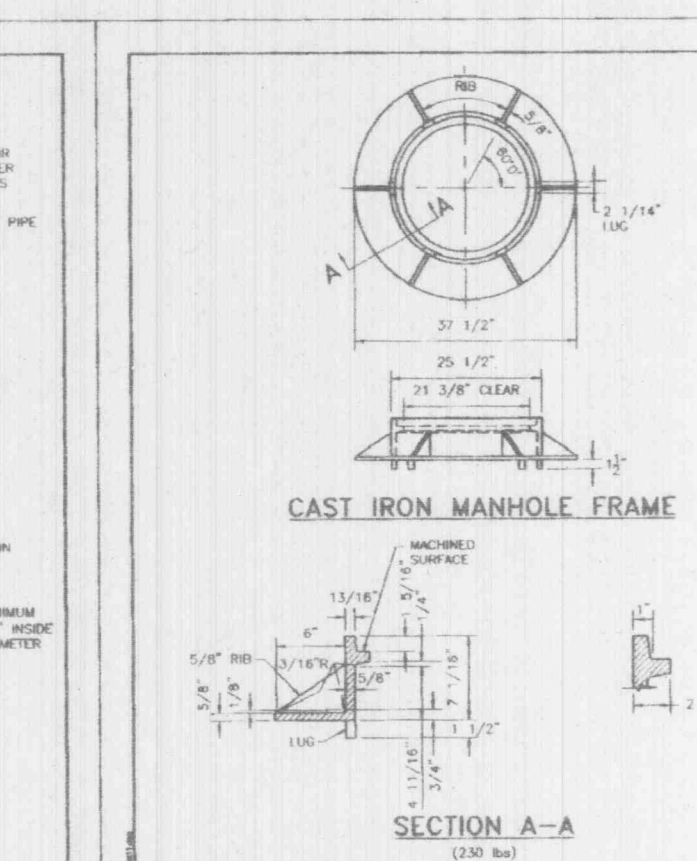
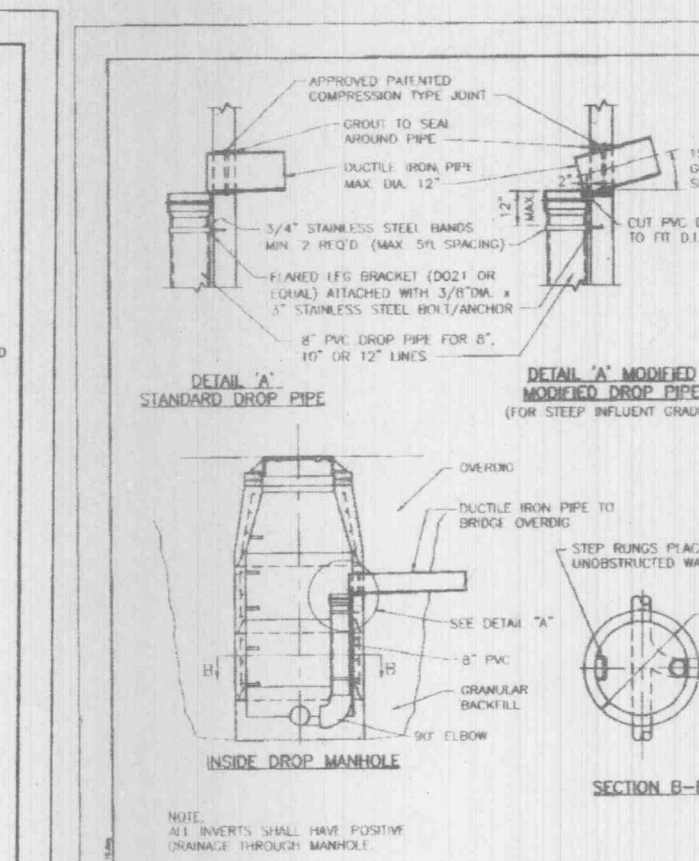
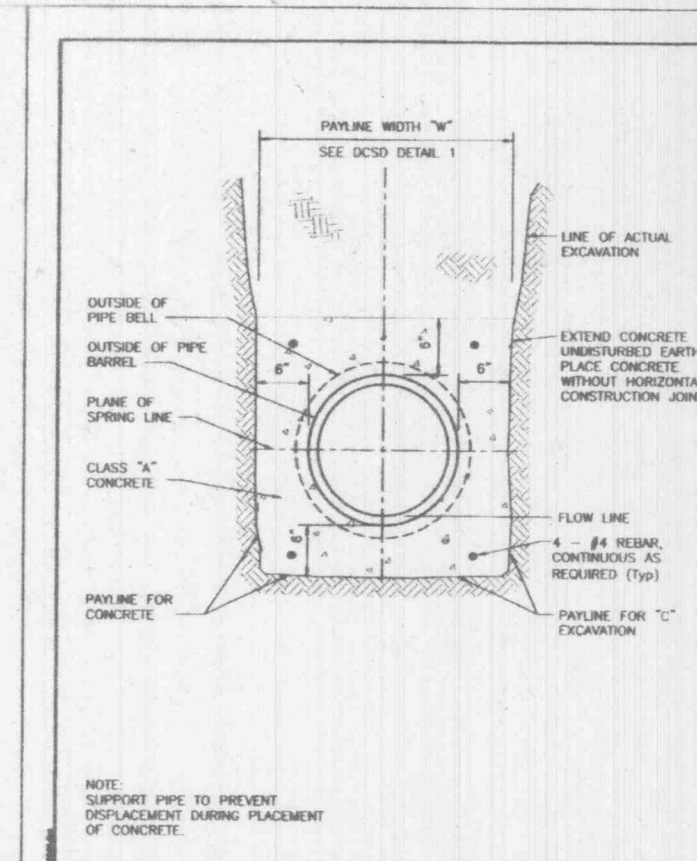
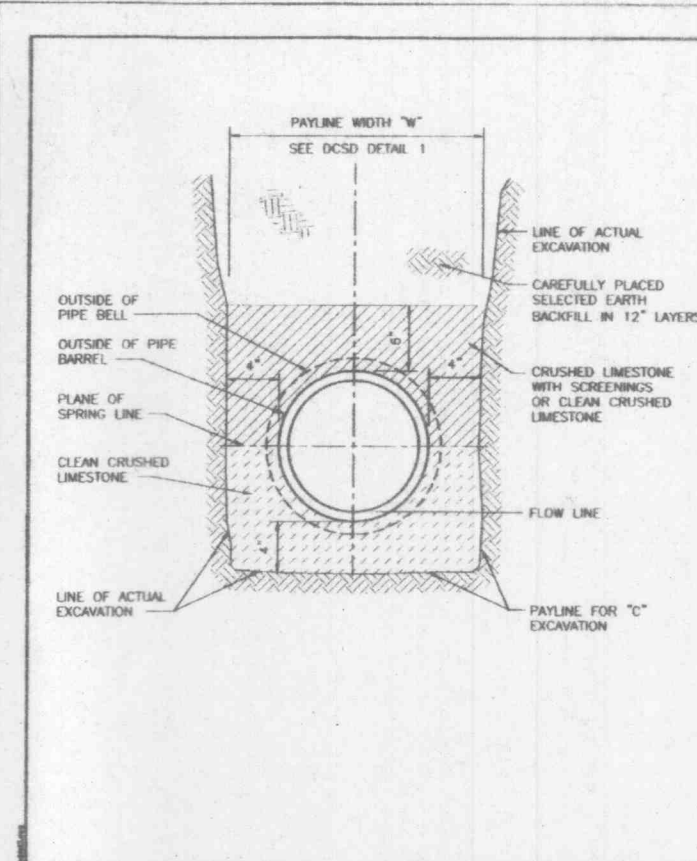
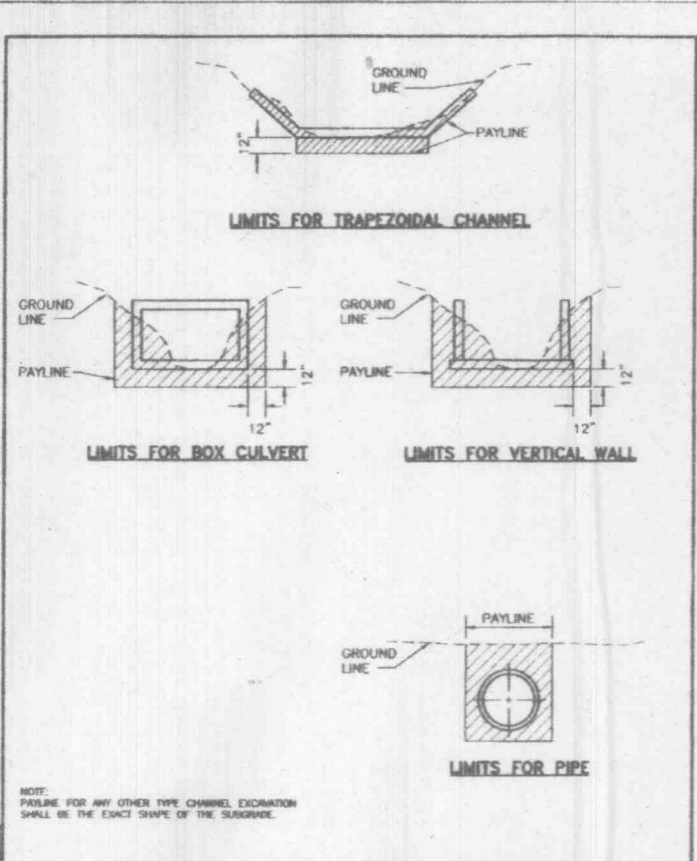

McEagle Development
689 CUBAG ROAD
ST. LOUIS, MISSOURI 63141
TEL: 314-433-4320
FAX: 314-433-4320

VOLZ
REGISTERED PROFESSIONAL ENGINEER
STATE OF MISSOURI
NO. 10004
EXPIRES 12-31-06

HILTON AT WINGHAVEN

CONSTRUCTION DETAILS

Design By: JWF
Drawn By: JRS
Checked By: JWF

B5930-22
02-13-02
06