

ROUND PIPE				HORIZONTAL ELLIPTICAL PIPE			
INSIDE DIAMETER OF PIPE (INCHES)	"W" PAYLINE WIDTH OF TRENCH (INCHES)	"W" PAYLINE WIDTH OF TRENCH (FEET)	PAY-LIMITS CONCRETE ENCASUREMENT (FEET PER FT)	INSIDE DIMENSIONS OF PIPE (INCHES)	"W" PAYLINE WIDTH OF TRENCH (INCHES)	"W" PAYLINE WIDTH OF TRENCH (FEET)	PAY-LIMITS CONCRETE ENCASUREMENT (FEET PER FT)
4	30	2.50	3.28				
6	30	2.50	3.59				
8	30	2.50	3.87				
10	30	2.50	4.09				
12	30	2.50	4.25				
15	36	3.00	5.58				
18	36	3.00	5.77	14 x 23	41	3.42	5.94
20	36	3.00	6.41				
24	42	3.50	7.39	19 x 30	49	4.08	7.68
27	42	3.50	8.18	22 x 34	53	4.42	8.61
30	42	3.50	8.90	24 x 38	58	4.83	9.70
33	42	3.50	10.53	27 x 43	62	5.17	10.71
36	42	3.50	11.43	29 x 45	66	5.50	11.72
39	42	3.50	13.16	32 x 49	71	5.92	13.14
42	42	3.50	13.38	34 x 53	75	6.25	14.05
45	42	3.50	15.67	36 x 60	83	6.92	16.18
48	42	3.50	18.15	43 x 68	92	7.87	18.81
54	48	4.00	20.73	48 x 76	101	8.42	21.59
60	48	4.00	23.45	53 x 83	109	9.08	24.35
66	48	4.00	26.37	58 x 91	118	9.83	27.45
72	54	4.50	29.39	63 x 98	128	10.50	30.50
78	54	4.50	32.57	68 x 106	135	11.25	33.91
84	54	4.50	35.90	72 x 113	143	11.92	36.93
90	54	4.50	39.37	77 x 121	152	12.67	40.69
96	54	4.50	42.99	82 x 128	160	13.33	44.45
102	54	4.50	46.75	87 x 136	168	14.00	47.79
108	54	4.50	50.65	92 x 143	176	14.67	51.70
114	54	4.50	54.72	97 x 151	185	15.42	56.01
120	54	4.50	58.92				
126	54	4.50	63.27				
132	54	4.50	67.77				
138	54	4.50	72.42				

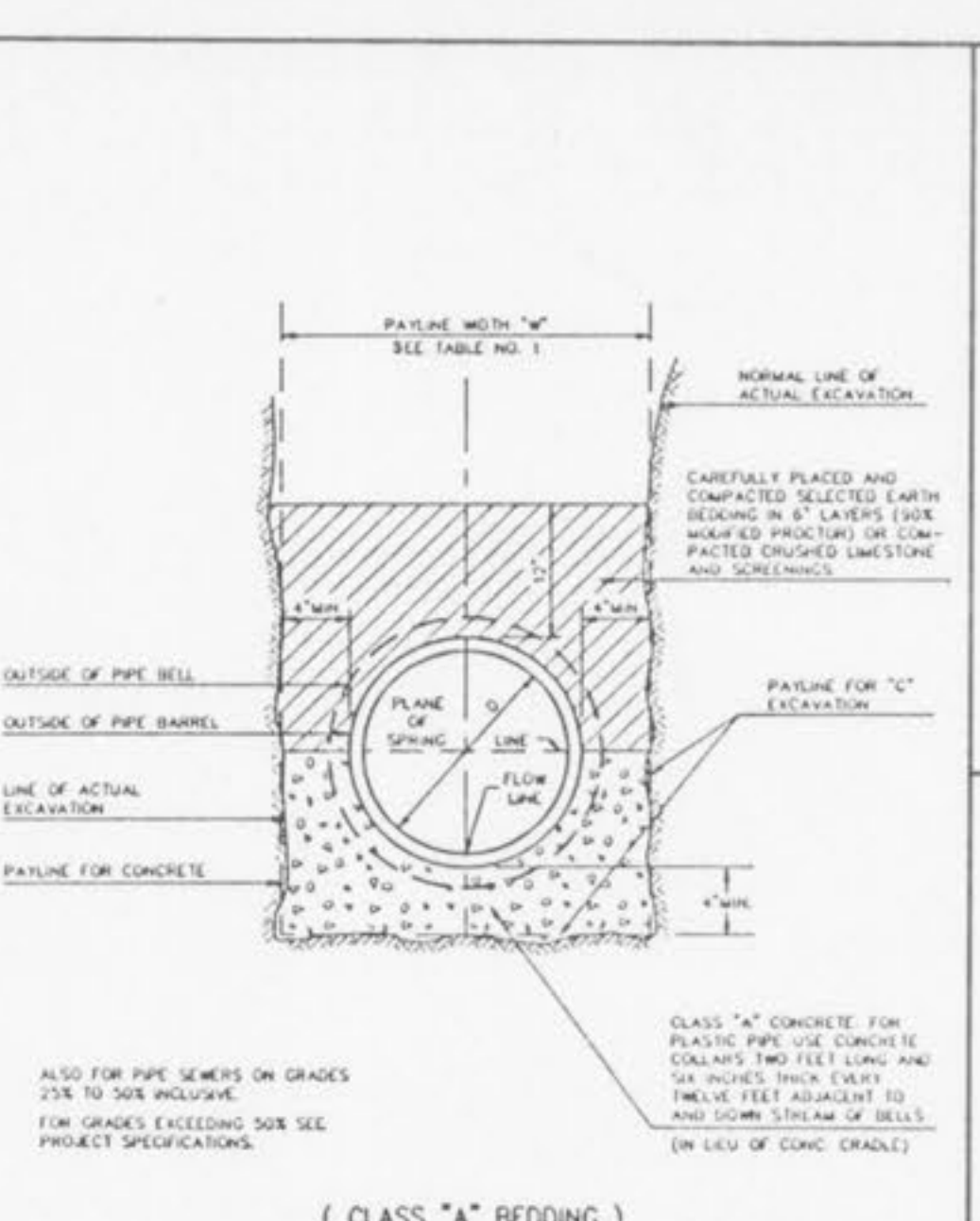
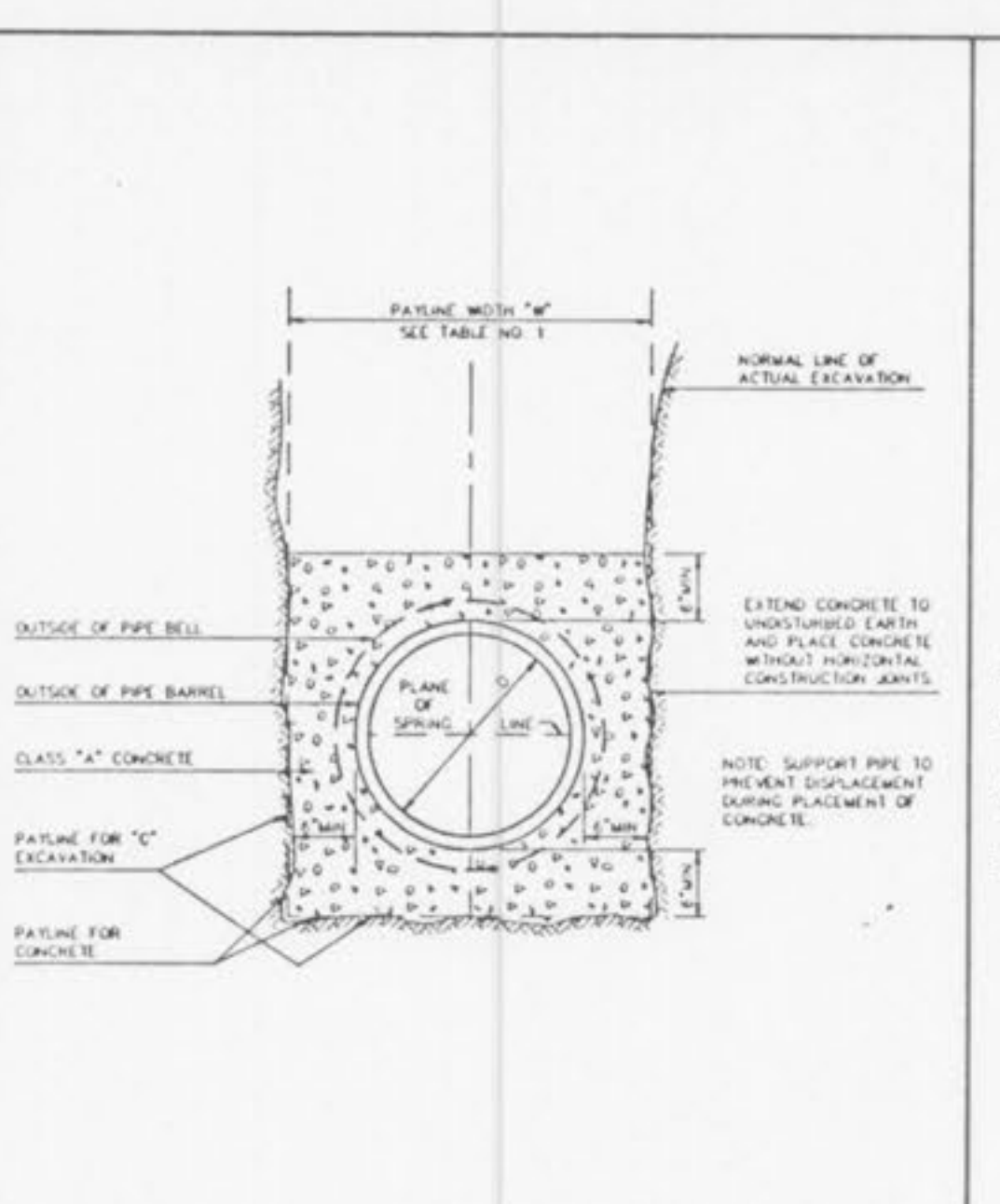
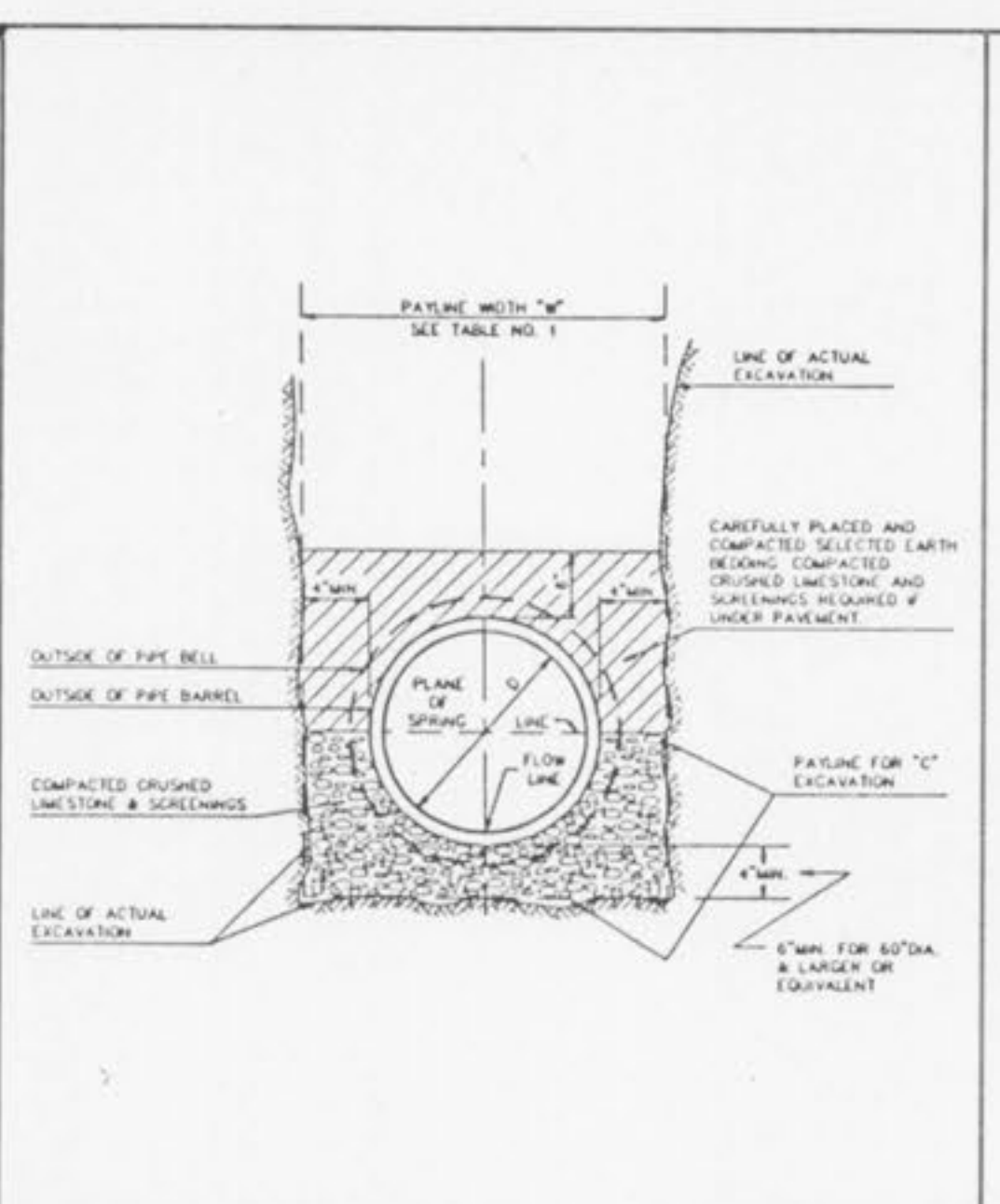
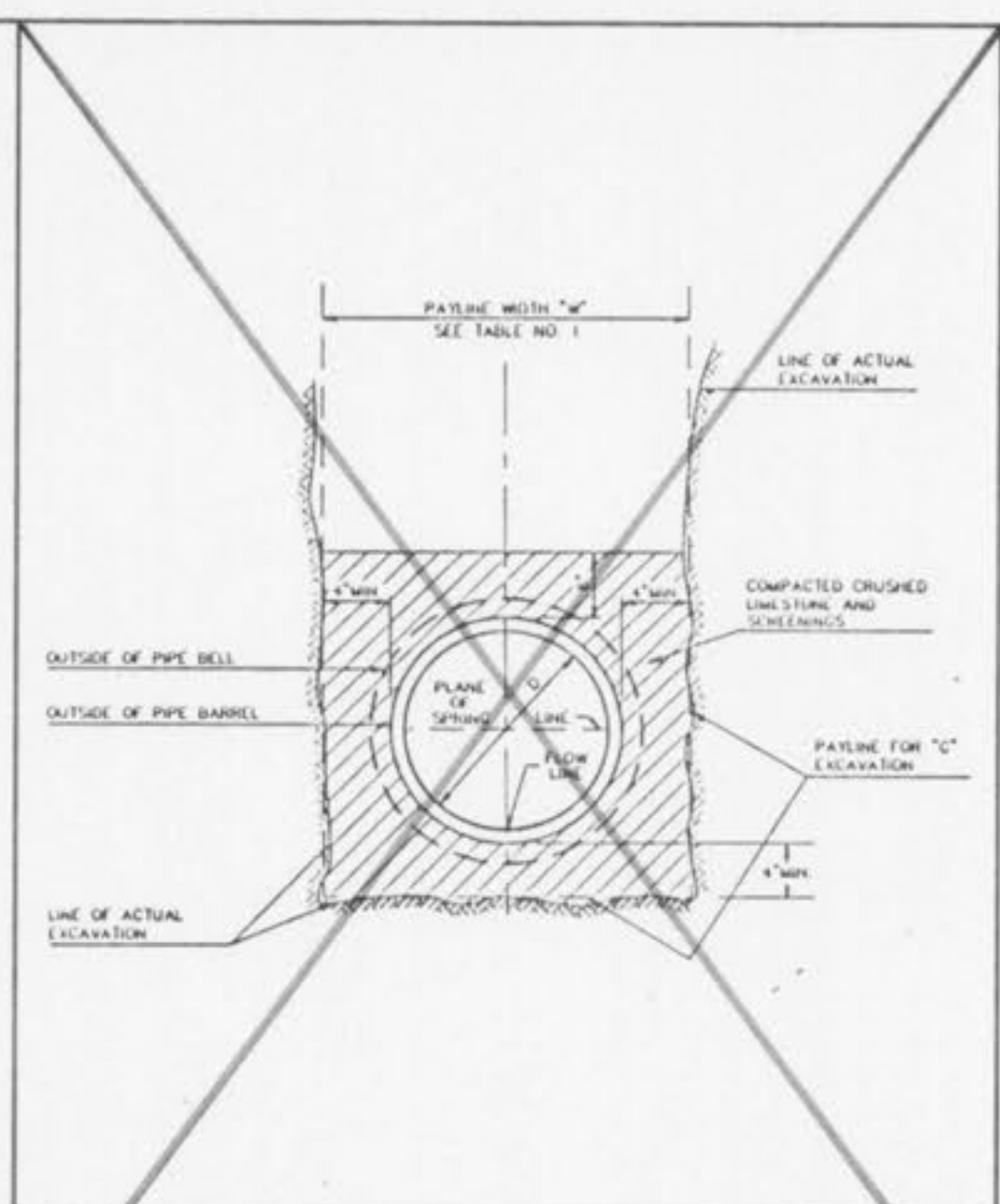
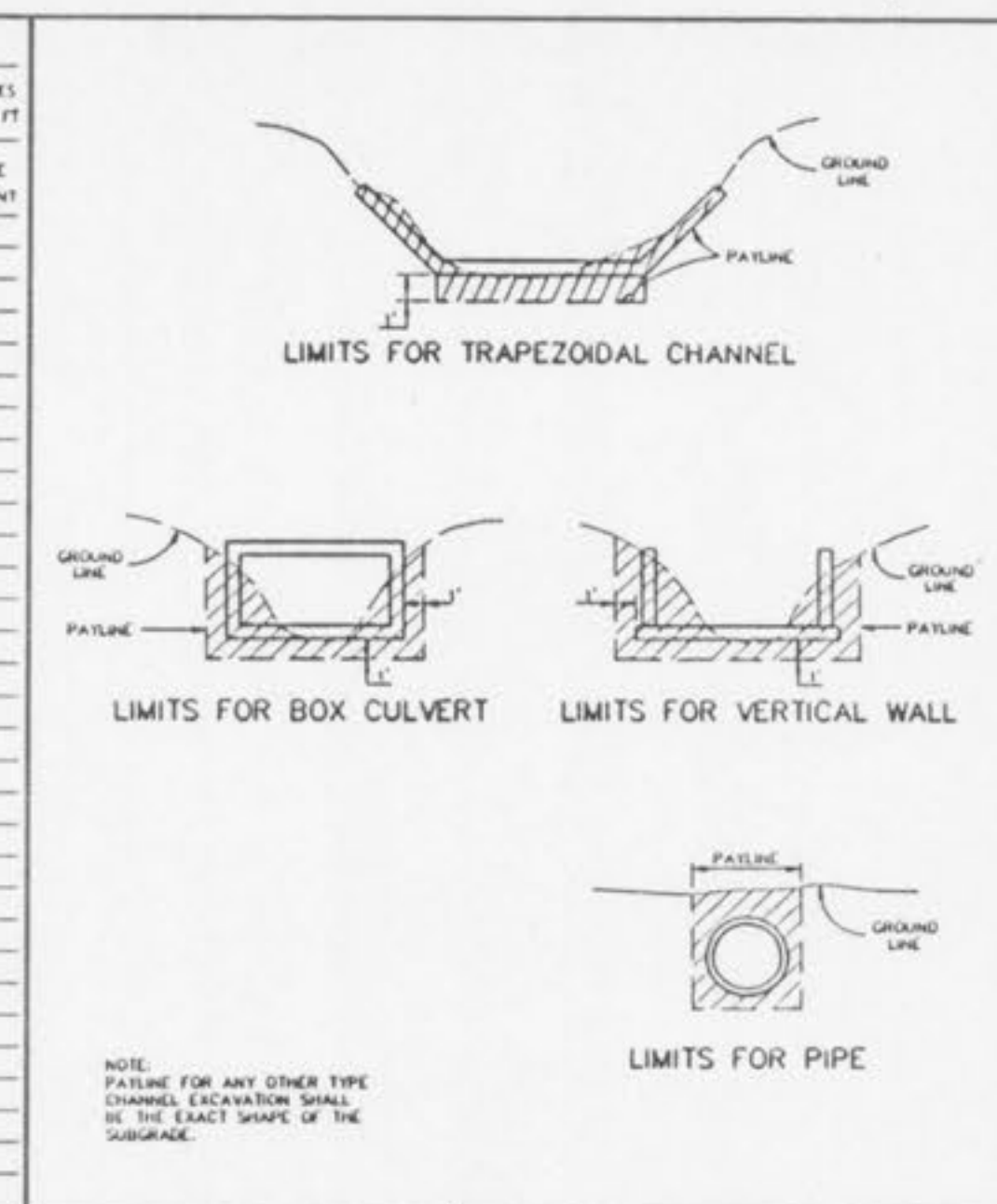

TABLE 1  
PAYLINE WIDTHS OF TRENCH AND PAY-QUANTITIES OF CONCRETE

METROPOLITAN ST. LOUIS SEWER DISTRICT  
Standard Details of Sewer Construction  
Dr. B.E.B. Ch. J.C.K. 1992 SHEET 1

METROPOLITAN ST. LOUIS SEWER DISTRICT  
Standard Details of Sewer Construction  
Dr. W.S.H. Ch. J.C.K. 1992 SHEET 2

METROPOLITAN ST. LOUIS SEWER DISTRICT  
Standard Details of Sewer Construction  
Dr. W.S.H. Ch. J.C.K. 1992 SHEET 3

METROPOLITAN ST. LOUIS SEWER DISTRICT  
Standard Details of Sewer Construction  
Dr. W.S.H. Ch. J.C.K. 1992 SHEET 4

METROPOLITAN ST. LOUIS SEWER DISTRICT  
Standard Details of Sewer Construction  
Dr. W.S.H. Ch. J.C.K. 1992 SHEET 5

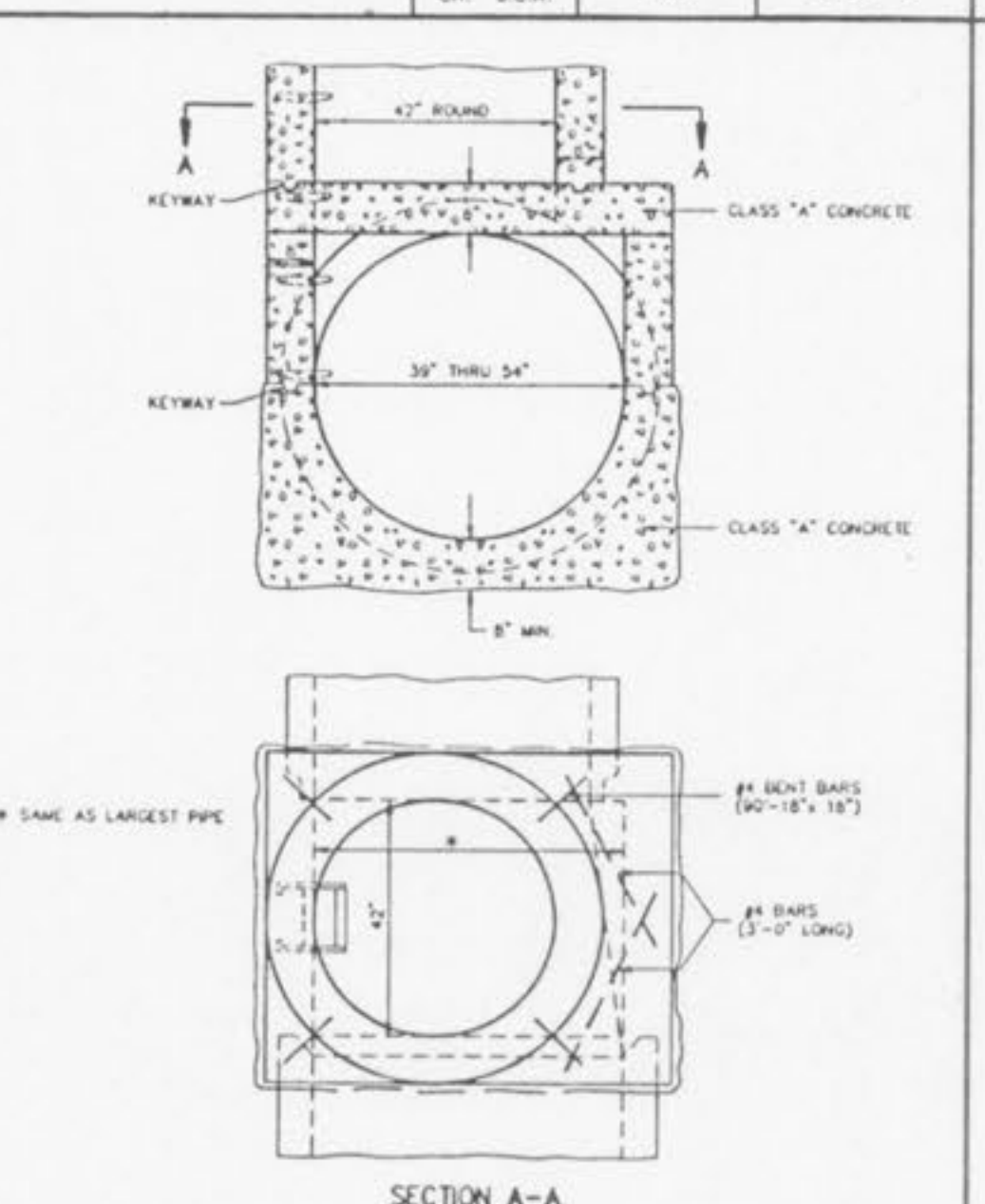
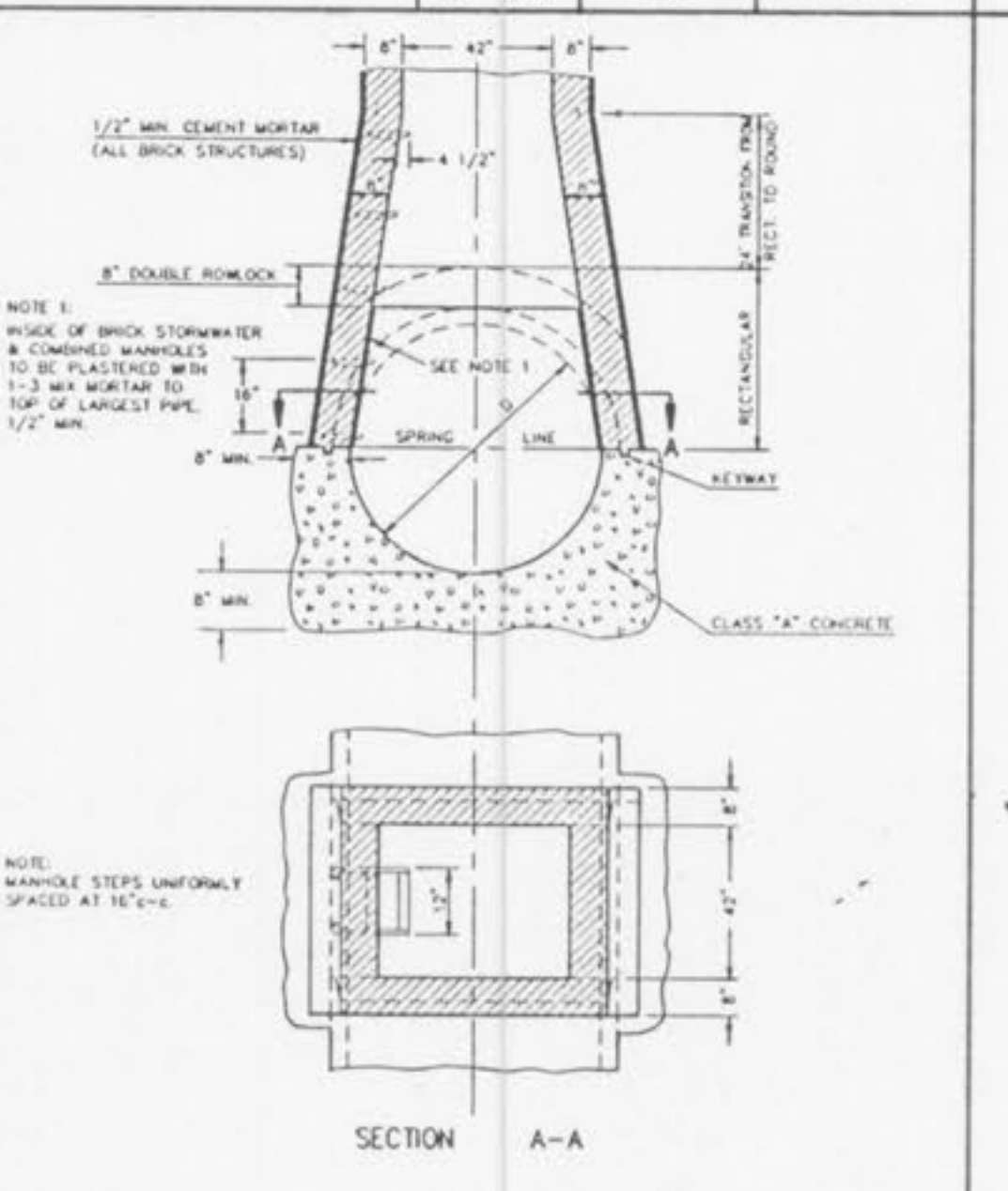
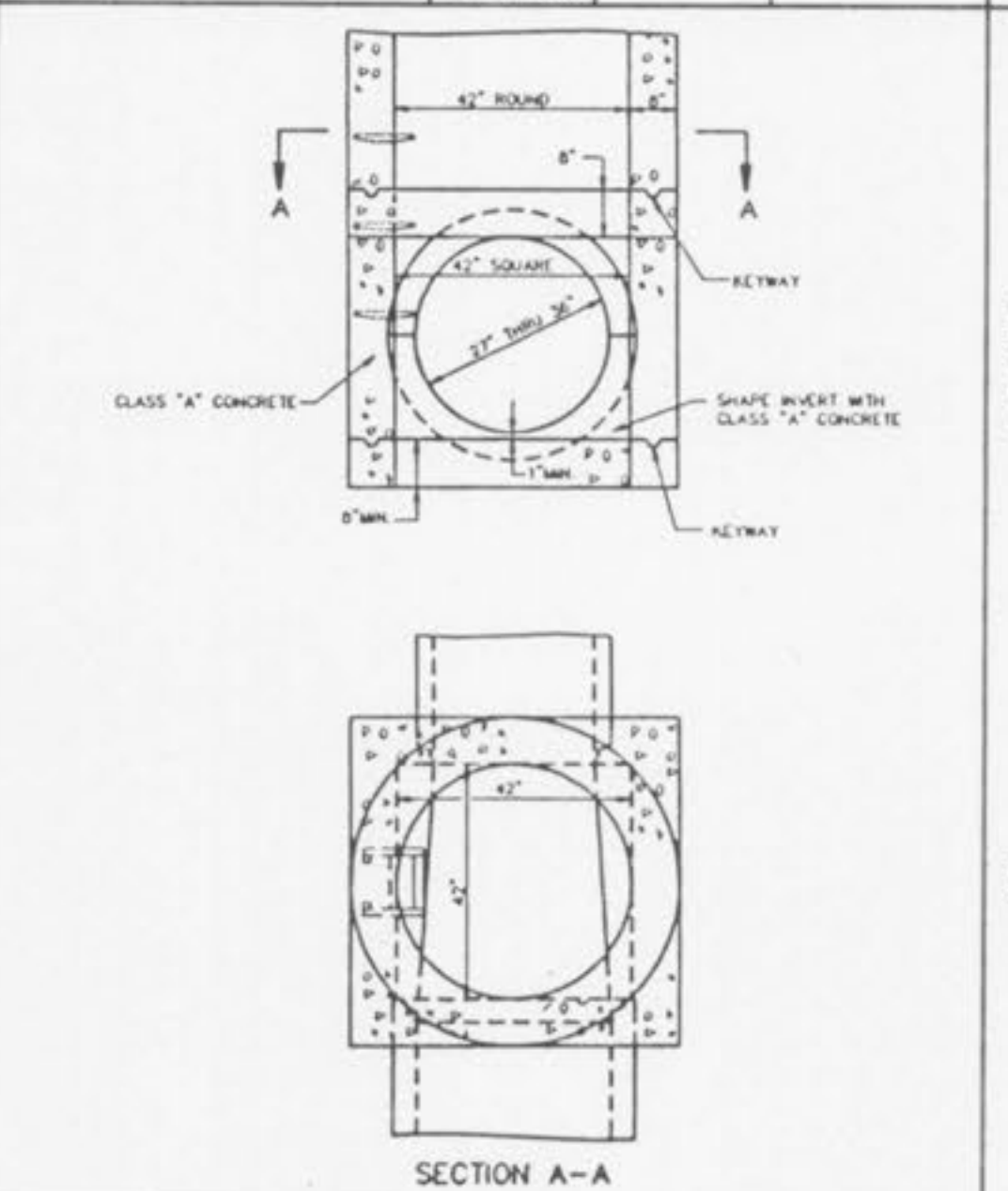
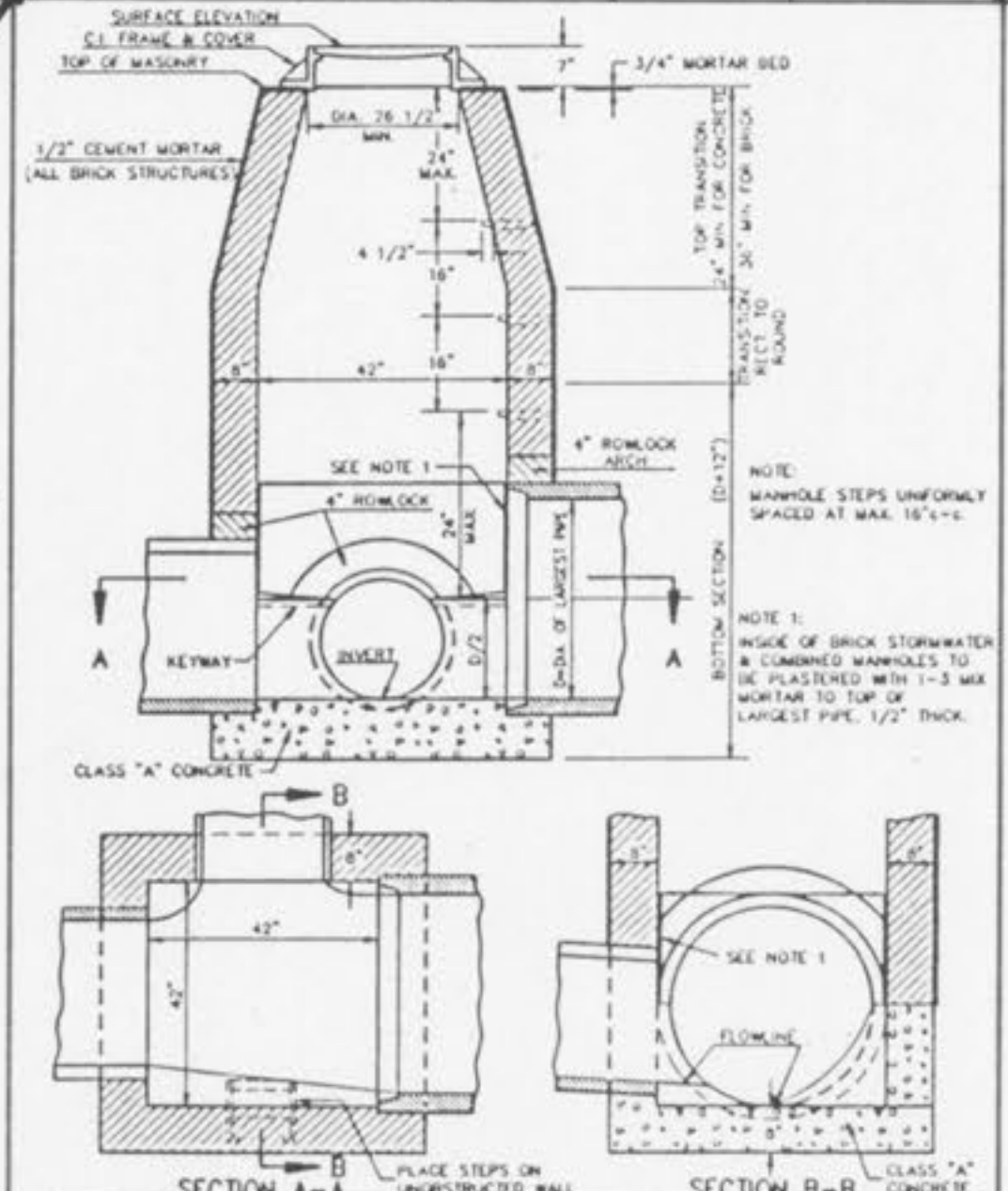
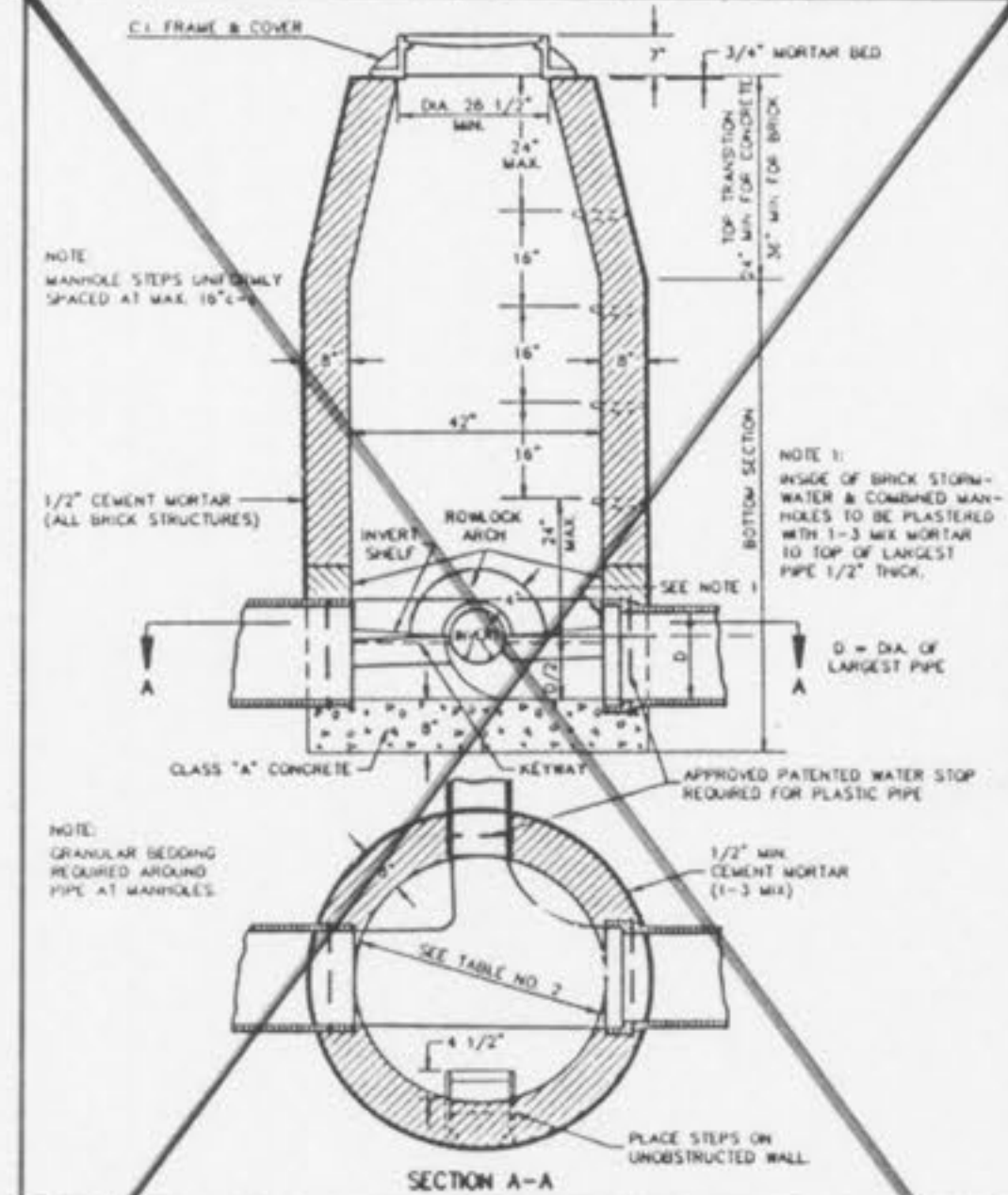
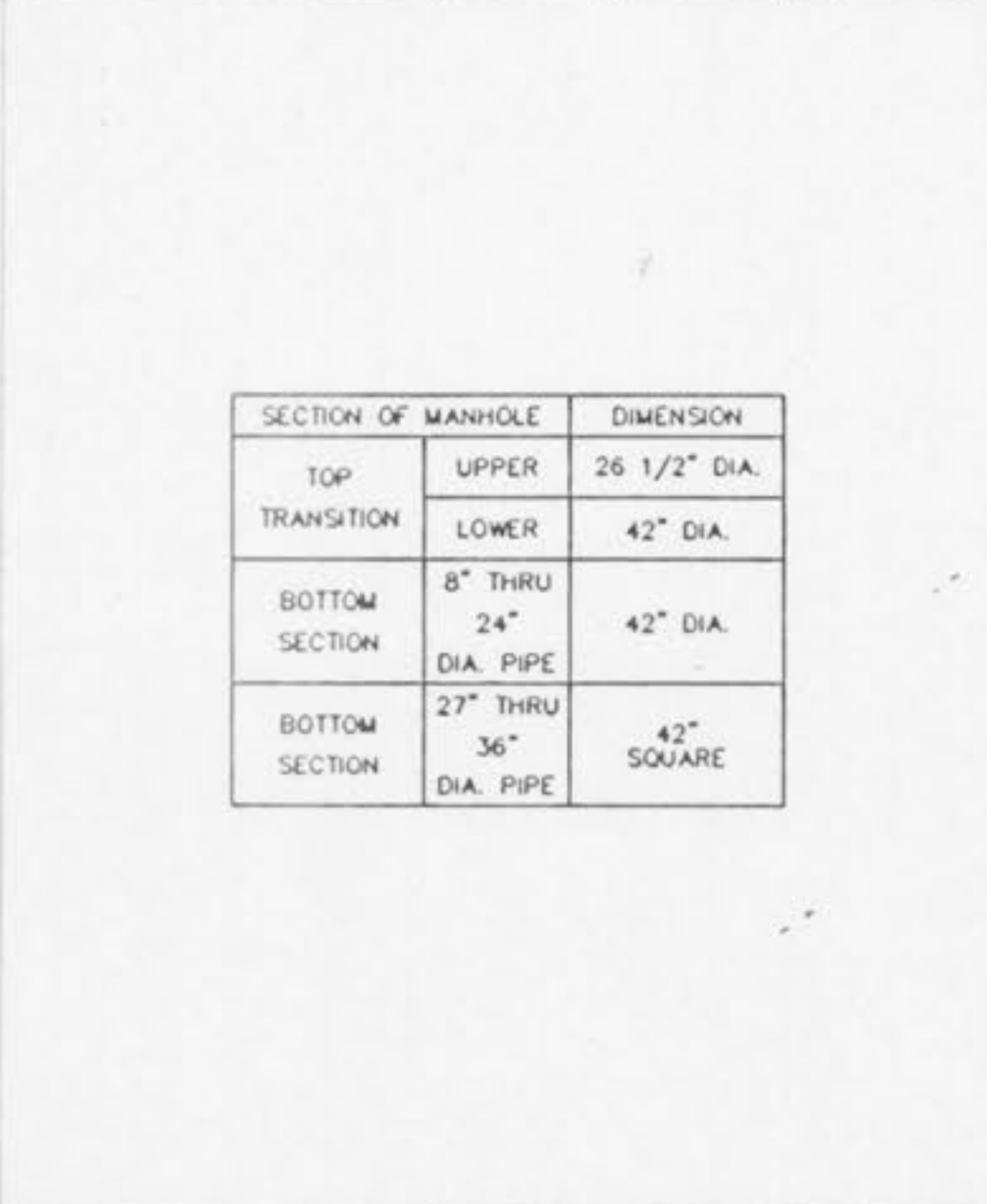

TABLE NO. 2  
STANDARD MANHOLE DIMENSIONS

METROPOLITAN ST. LOUIS SEWER DISTRICT  
Standard Details of Sewer Construction  
Dr. R.W.C. Ch. J.C.K. 1992 SHEET 7

METROPOLITAN ST. LOUIS SEWER DISTRICT  
Standard Details of Sewer Construction  
Dr. W.S.H. Ch. J.C.K. 1992 SHEET 8

METROPOLITAN ST. LOUIS SEWER DISTRICT  
Standard Details of Sewer Construction  
Dr. W.S.H. Ch. J.C.K. 1992 SHEET 9

METROPOLITAN ST. LOUIS SEWER DISTRICT  
Standard Details of Sewer Construction  
Dr. D.A.B. Ch. J.C.K. 1992 SHEET 10

METROPOLITAN ST. LOUIS SEWER DISTRICT  
Standard Details of Sewer Construction  
Dr. W.S.H. Ch. J.C.K. 1992 SHEET 11

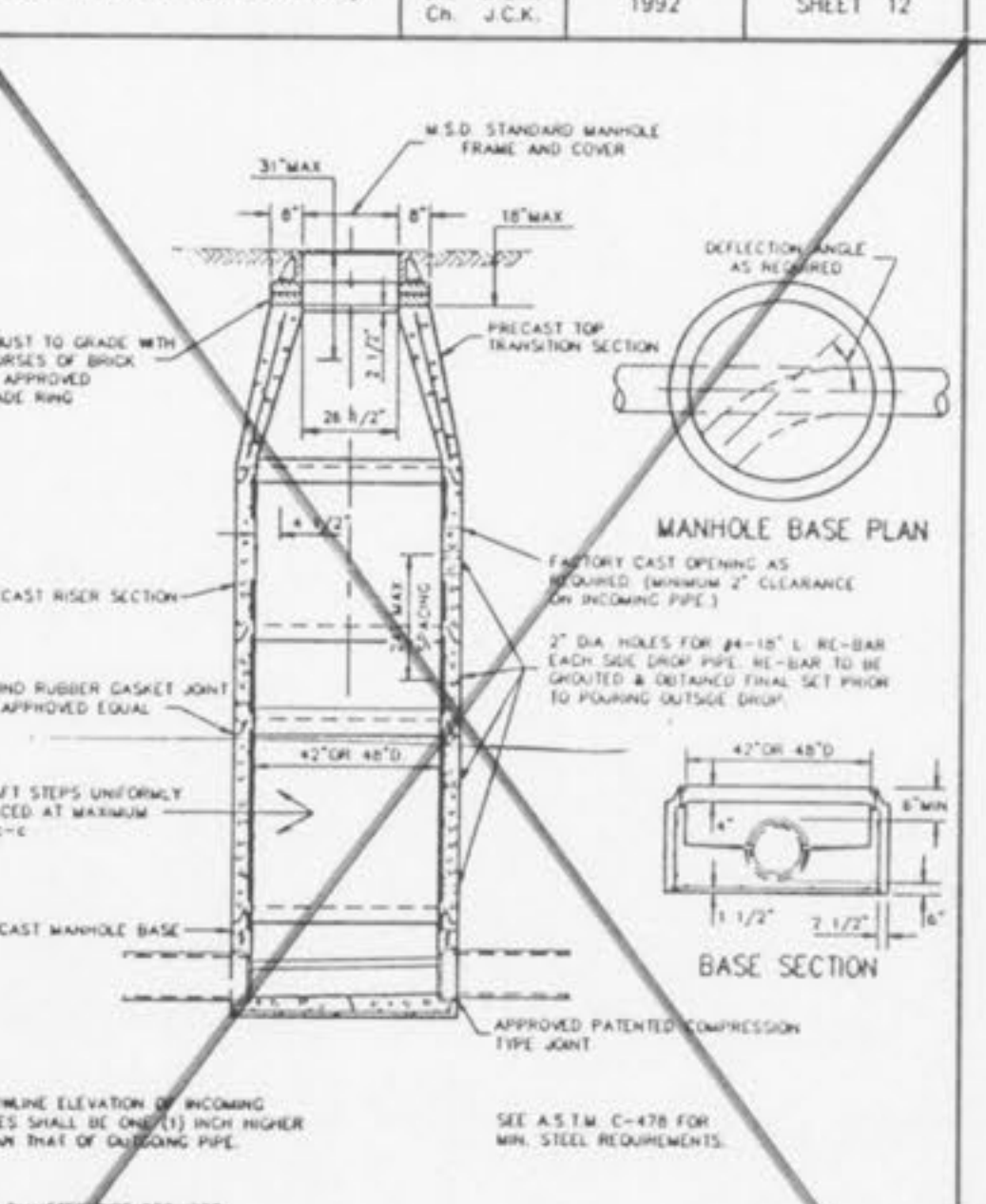
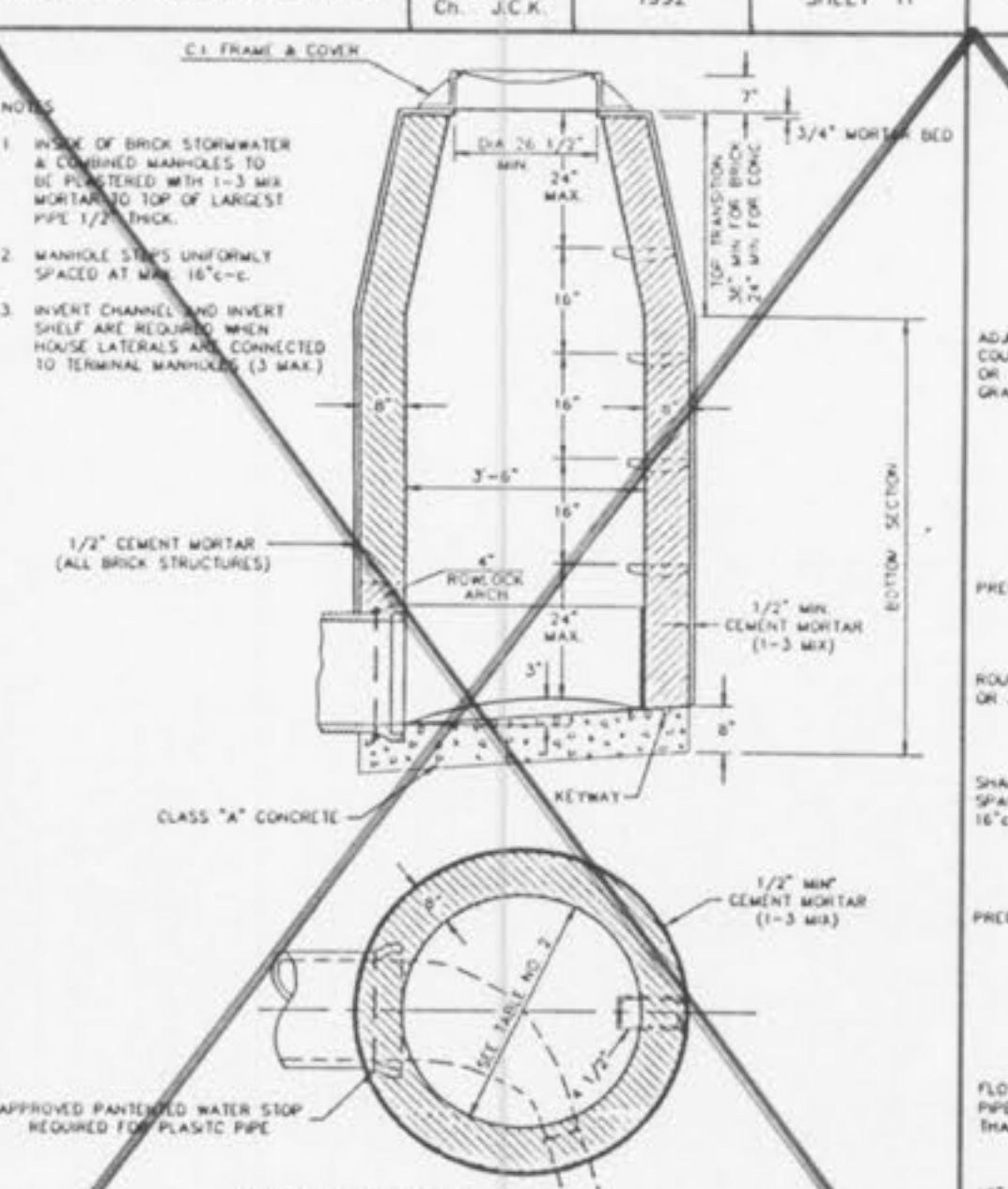
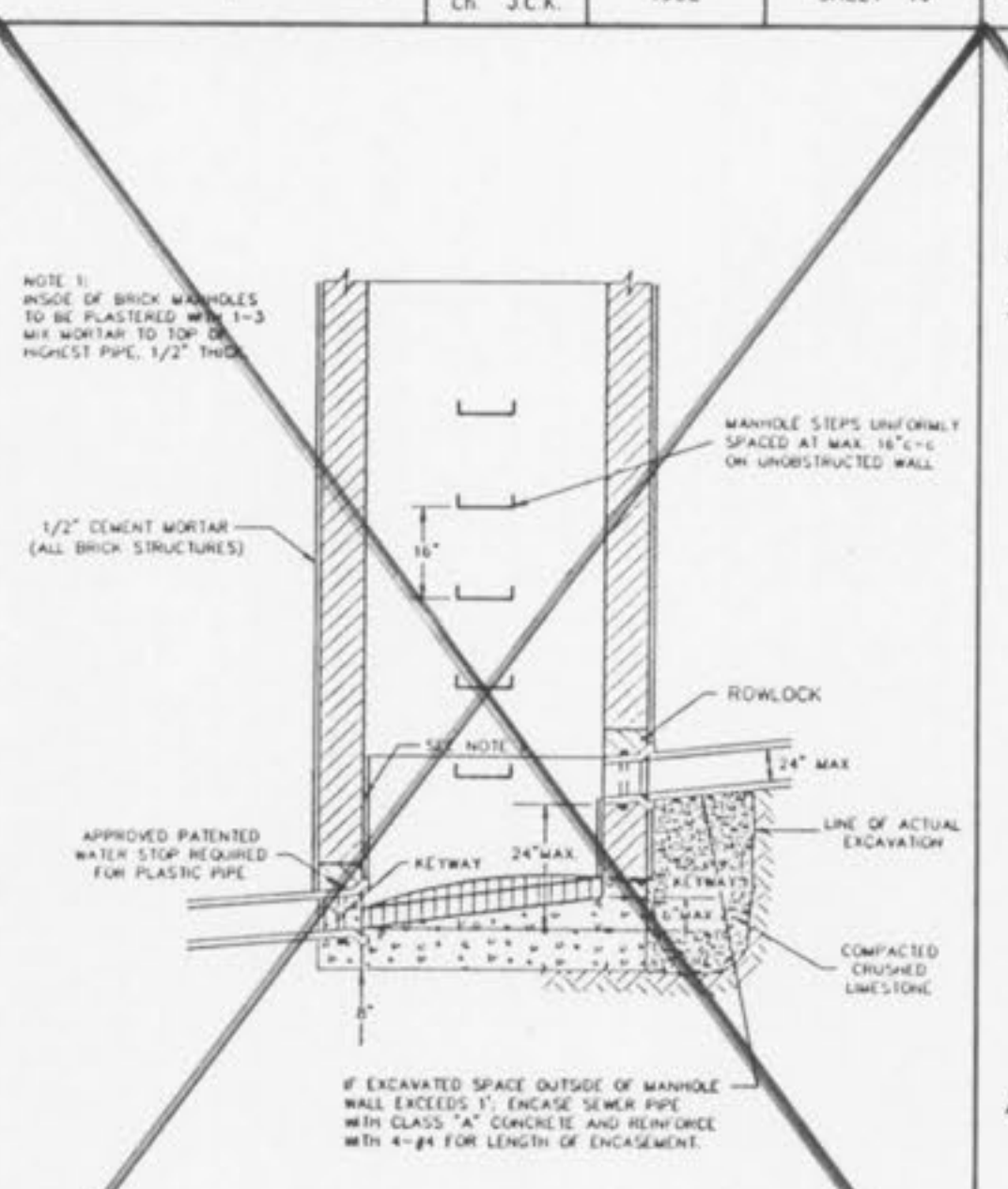
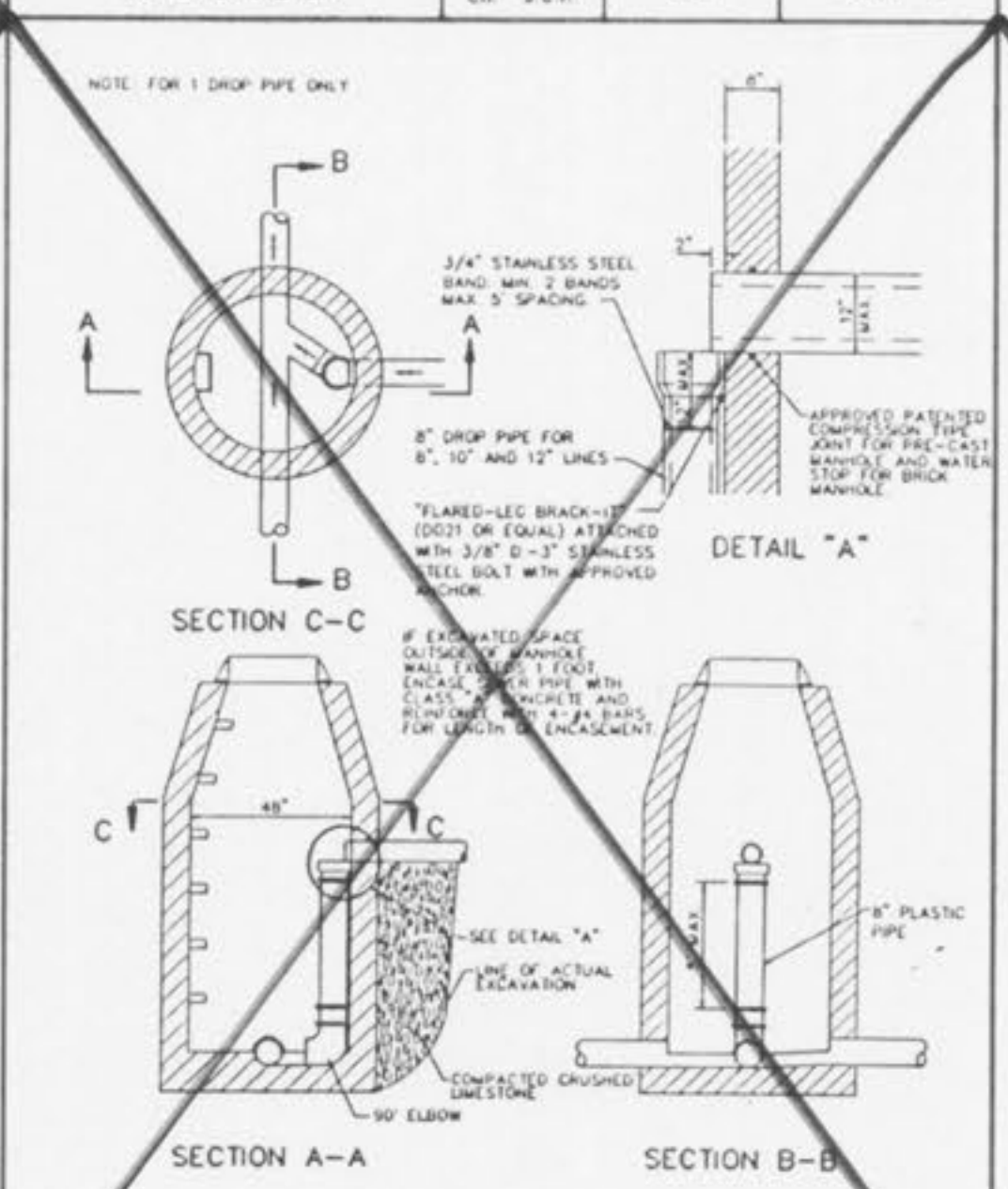
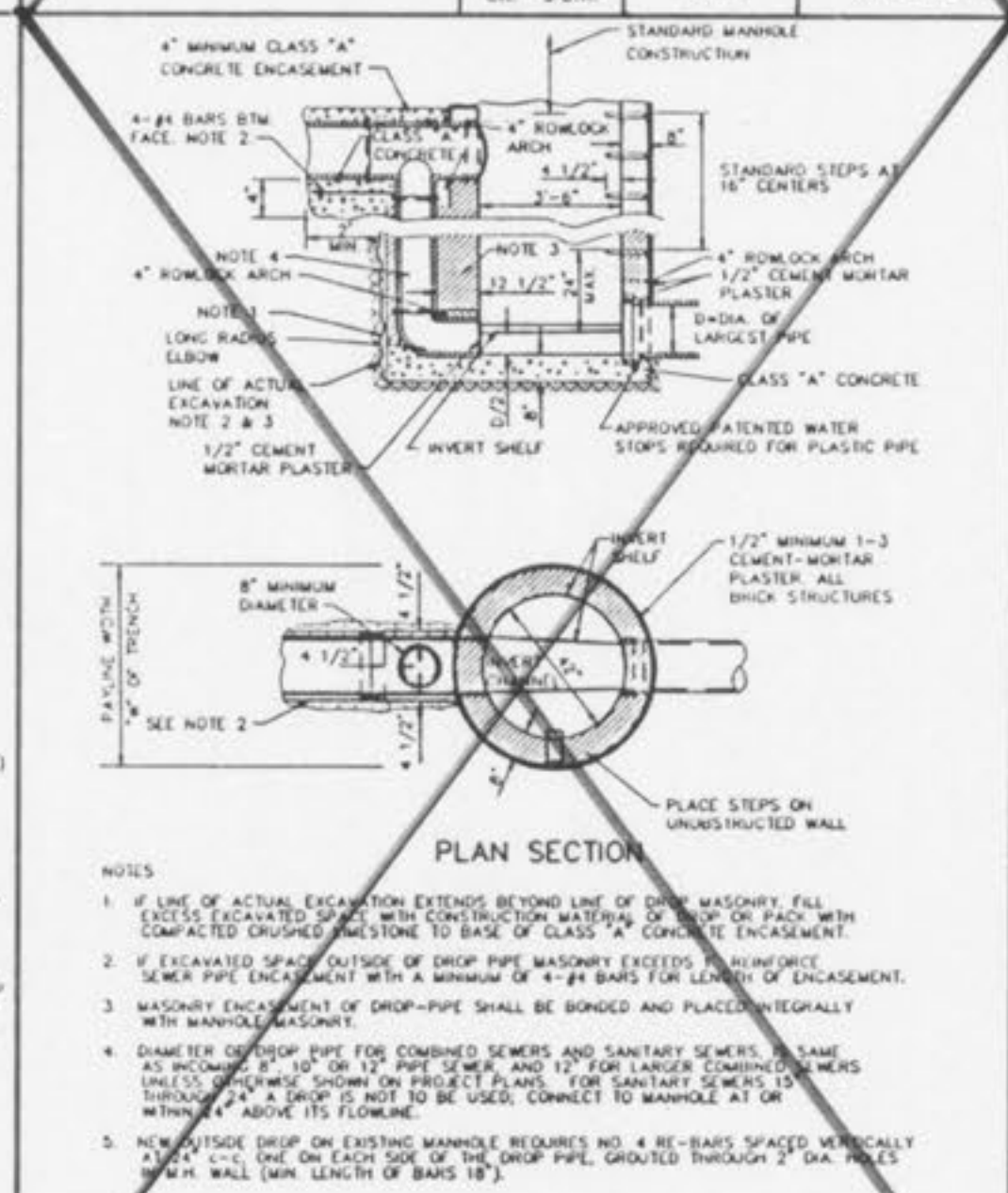
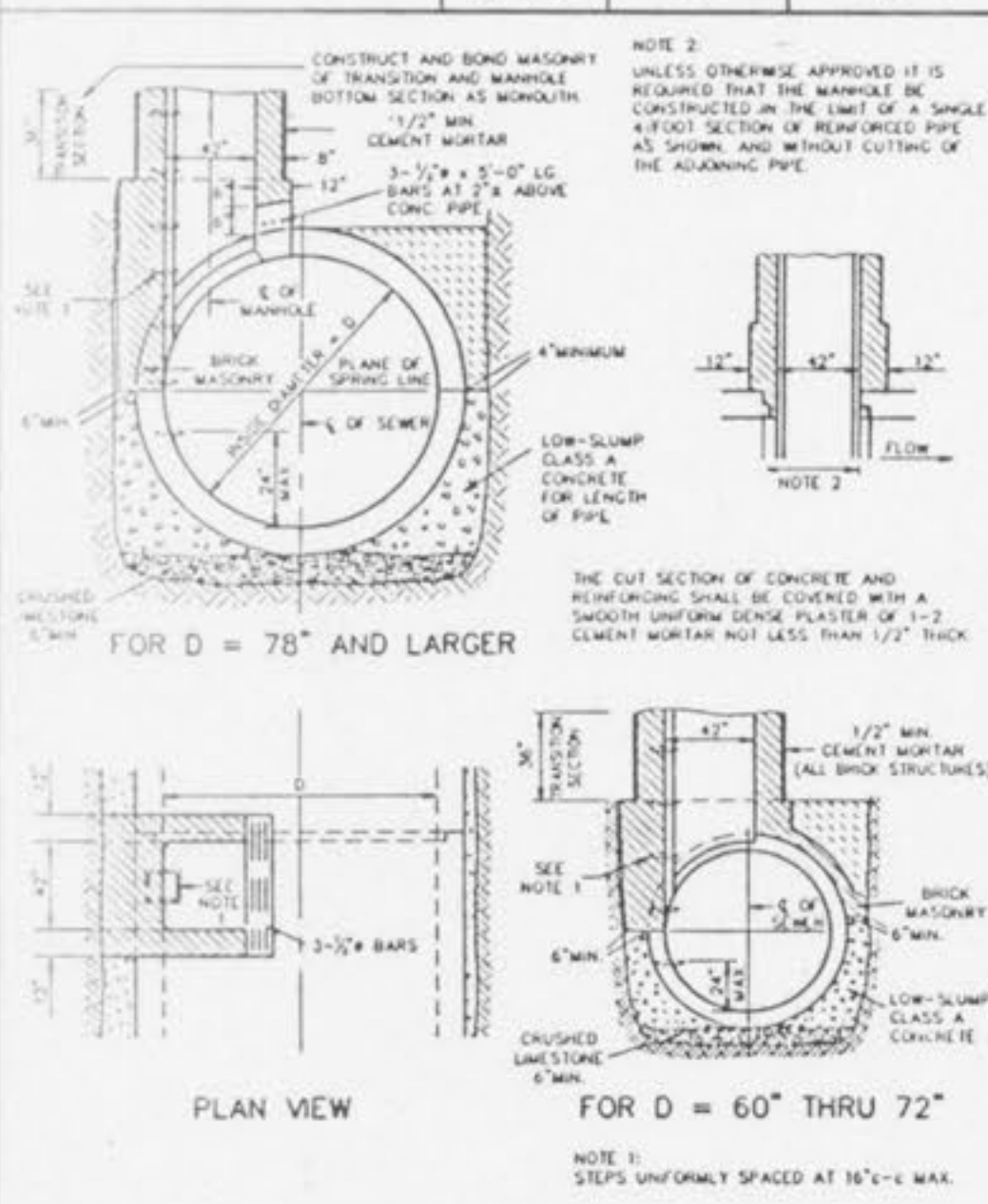

METROPOLITAN ST. LOUIS SEWER DISTRICT  
Standard Details of Sewer Construction  
Dr. W.S.H. Ch. J.C.K. 1992 SHEET 13

METROPOLITAN ST. LOUIS SEWER DISTRICT  
Standard Details of Sewer Construction  
Dr. R.W.C. Ch. J.C.K. 1992 SHEET 14

METROPOLITAN ST. LOUIS SEWER DISTRICT  
Standard Details of Sewer Construction  
Dr. R.W.C. Ch. J.C.K. 1992 SHEET 15

METROPOLITAN ST. LOUIS SEWER DISTRICT  
Standard Details of Sewer Construction  
Dr. W.S.H. Ch. J.C.K. 1992 SHEET 16

METROPOLITAN ST. LOUIS SEWER DISTRICT  
Standard Details of Sewer Construction  
Dr. W.S.H. Ch. J.C.K. 1992 SHEET 17

METROPOLITAN ST. LOUIS SEWER DISTRICT  
Standard Details of Sewer Construction  
Dr. W.S.H. Ch. J.C.K. 1992 SHEET 18