

PRE-CAST CONCRETE UNIT FOR SINGLE STREET INLET
 METROPOLITAN ST. LOUIS SEWER DISTRICT Standard Details of Sewer Construction
 Dr. W.S.H. Ch. J.C.K. 1992 SHEET 37

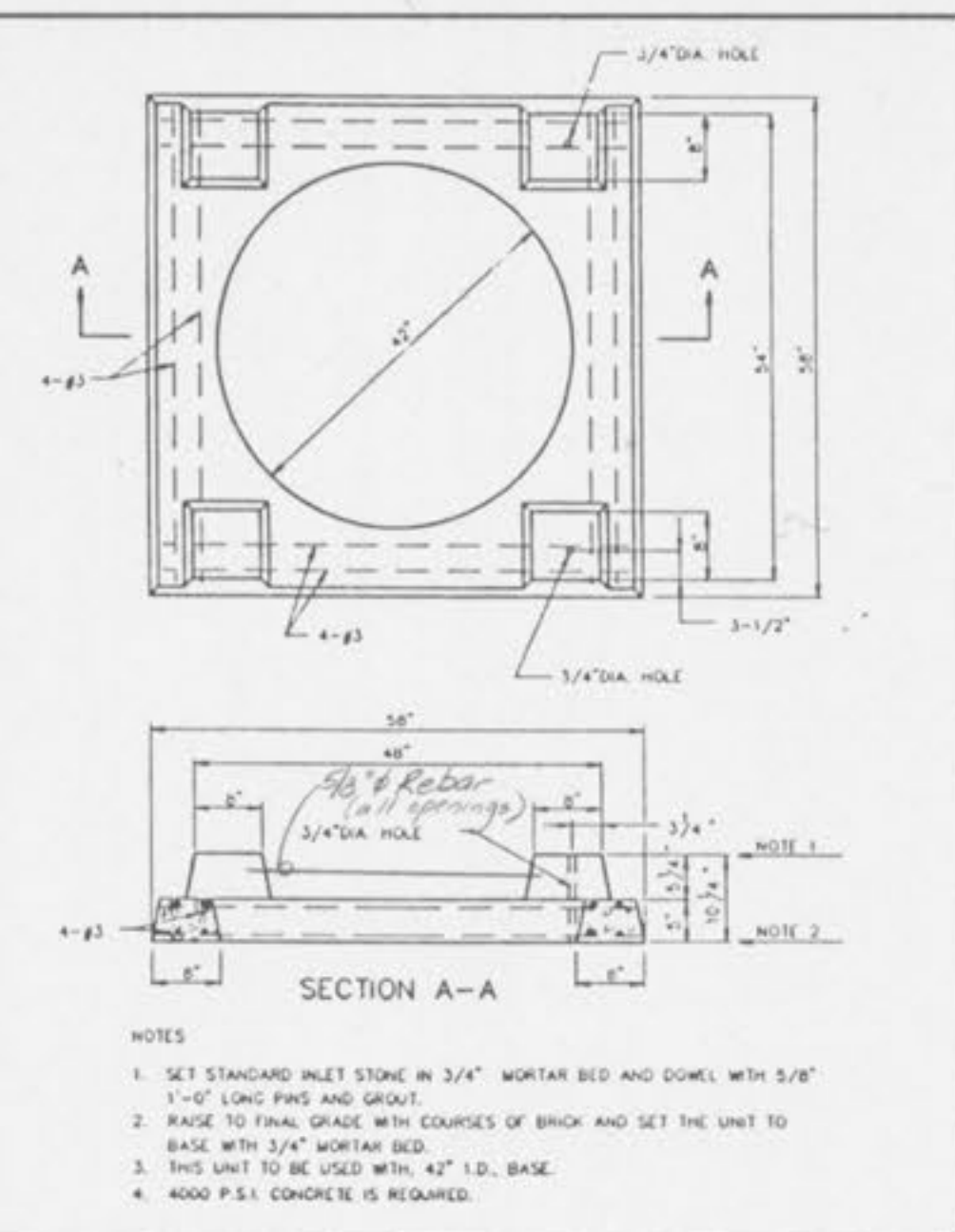

PRE-CAST CONCRETE UNIT FOR 4 WAY AREA INLET
 METROPOLITAN ST. LOUIS SEWER DISTRICT Standard Details of Sewer Construction
 Dr. D.A.B. Ch. J.C.K. 1992 SHEET 38

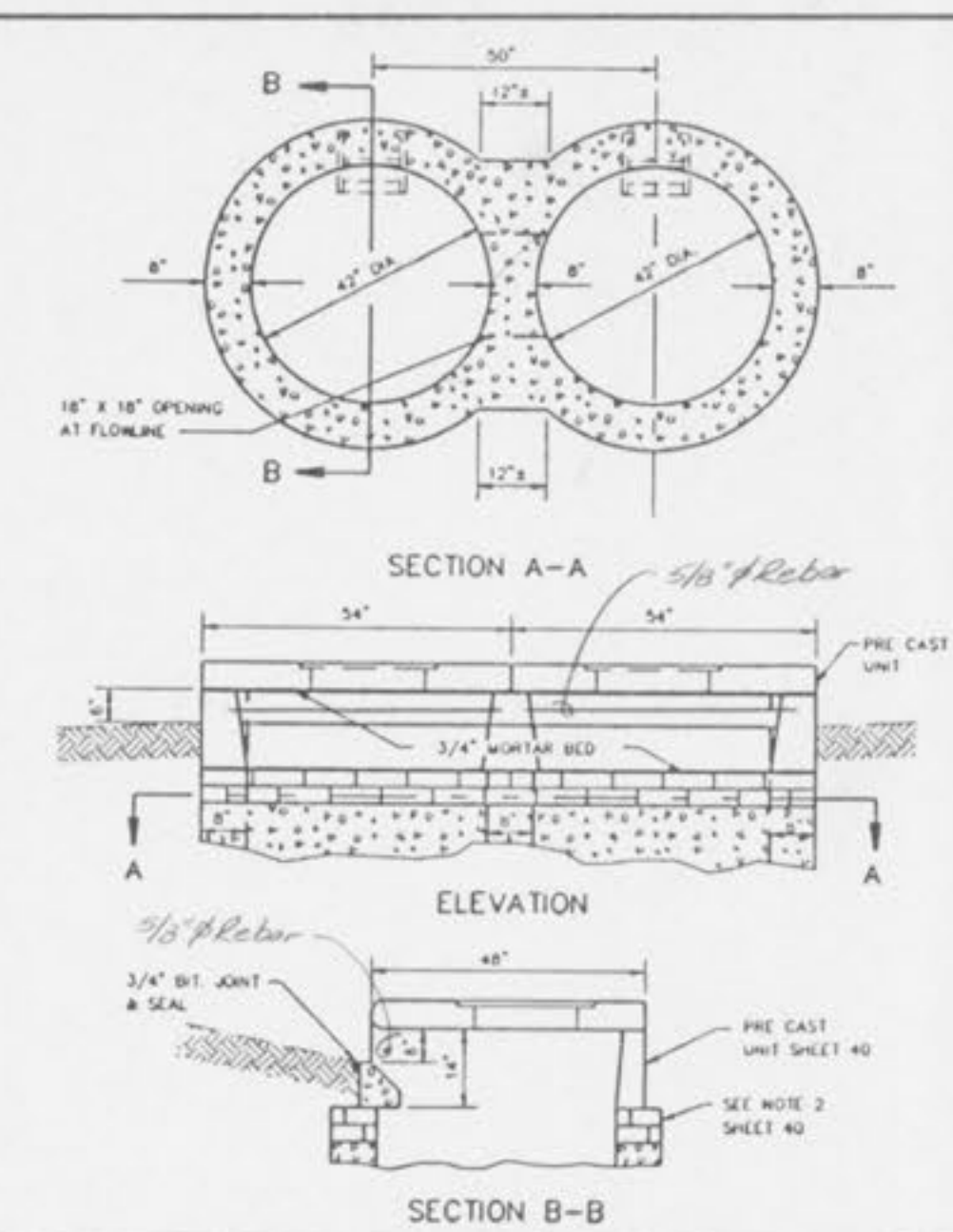

CONCRETE DOUBLE STREET INLET W/PRE CAST CONCRETE UNIT A
 METROPOLITAN ST. LOUIS SEWER DISTRICT Standard Details of Sewer Construction
 Dr. R.C.W. Ch. J.C.K. 1992 SHEET 39

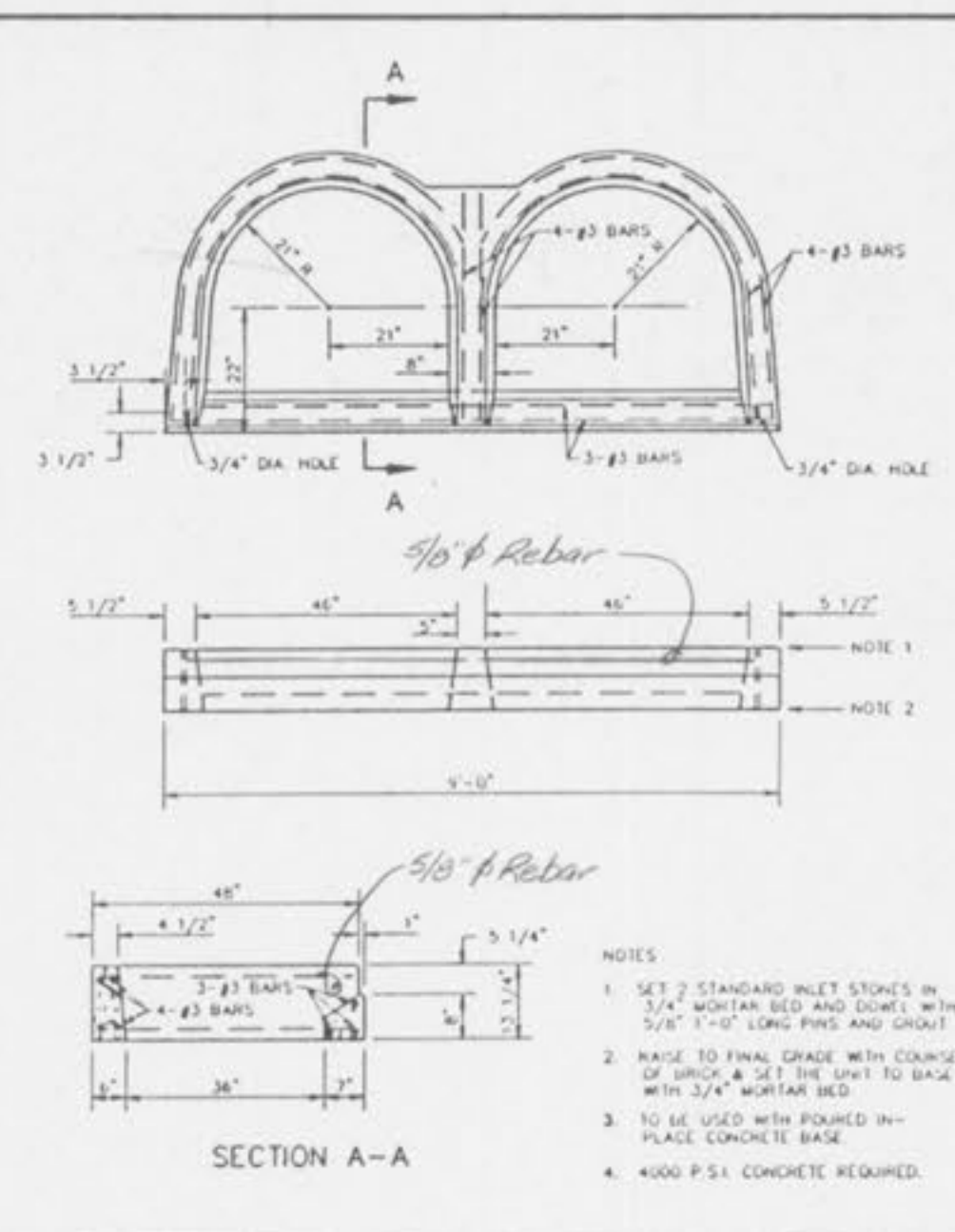

PRE-CAST CONCRETE UNIT A FOR STREET DOUBLE INLET
 METROPOLITAN ST. LOUIS SEWER DISTRICT Standard Details of Sewer Construction
 Dr. R.C.W. Ch. J.C.K. 1992 SHEET 40

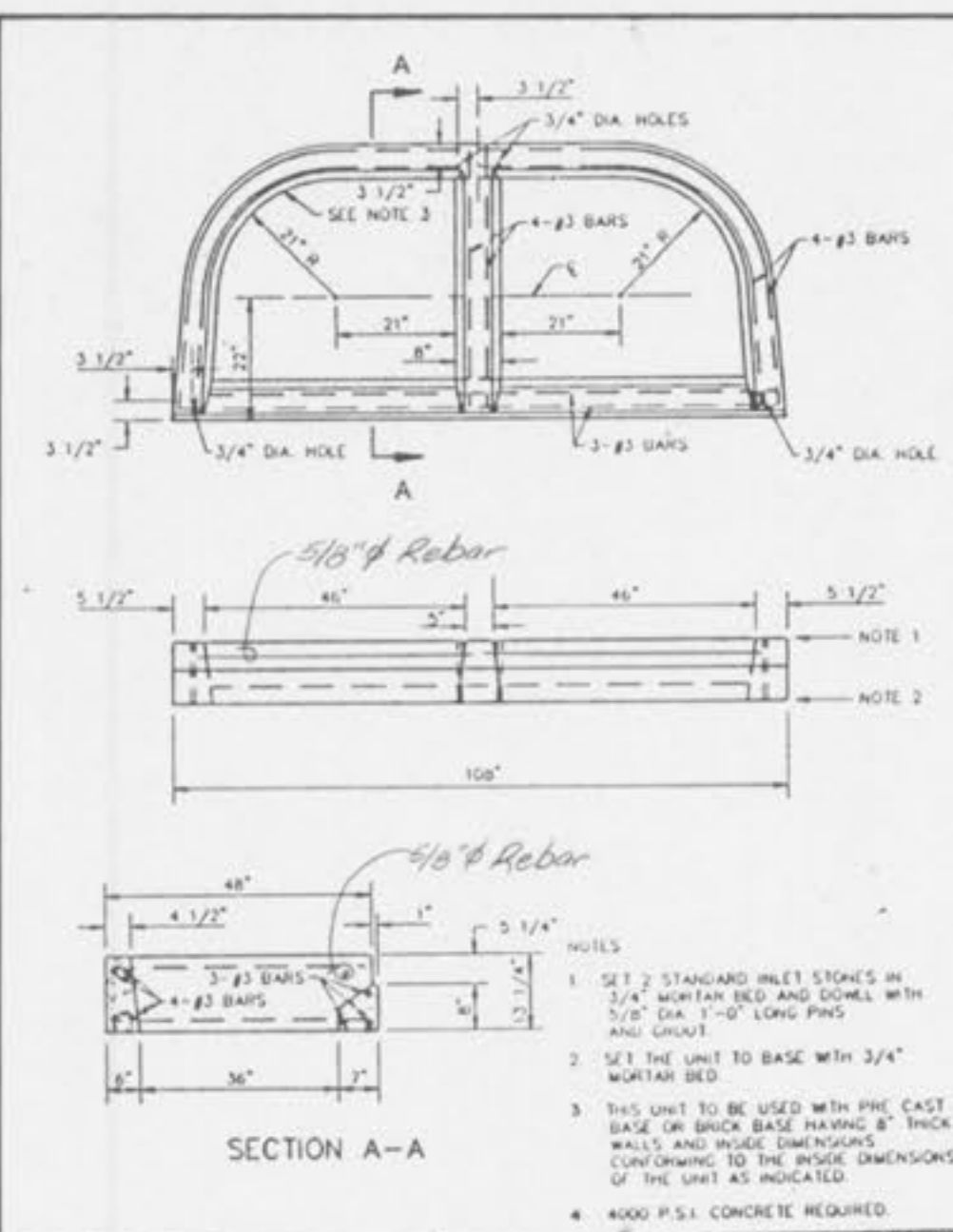

PRE-CAST CONCRETE UNIT B FOR STREET DOUBLE INLET
 METROPOLITAN ST. LOUIS SEWER DISTRICT Standard Details of Sewer Construction
 Dr. R.C.W. Ch. J.C.K. 1992 SHEET 41

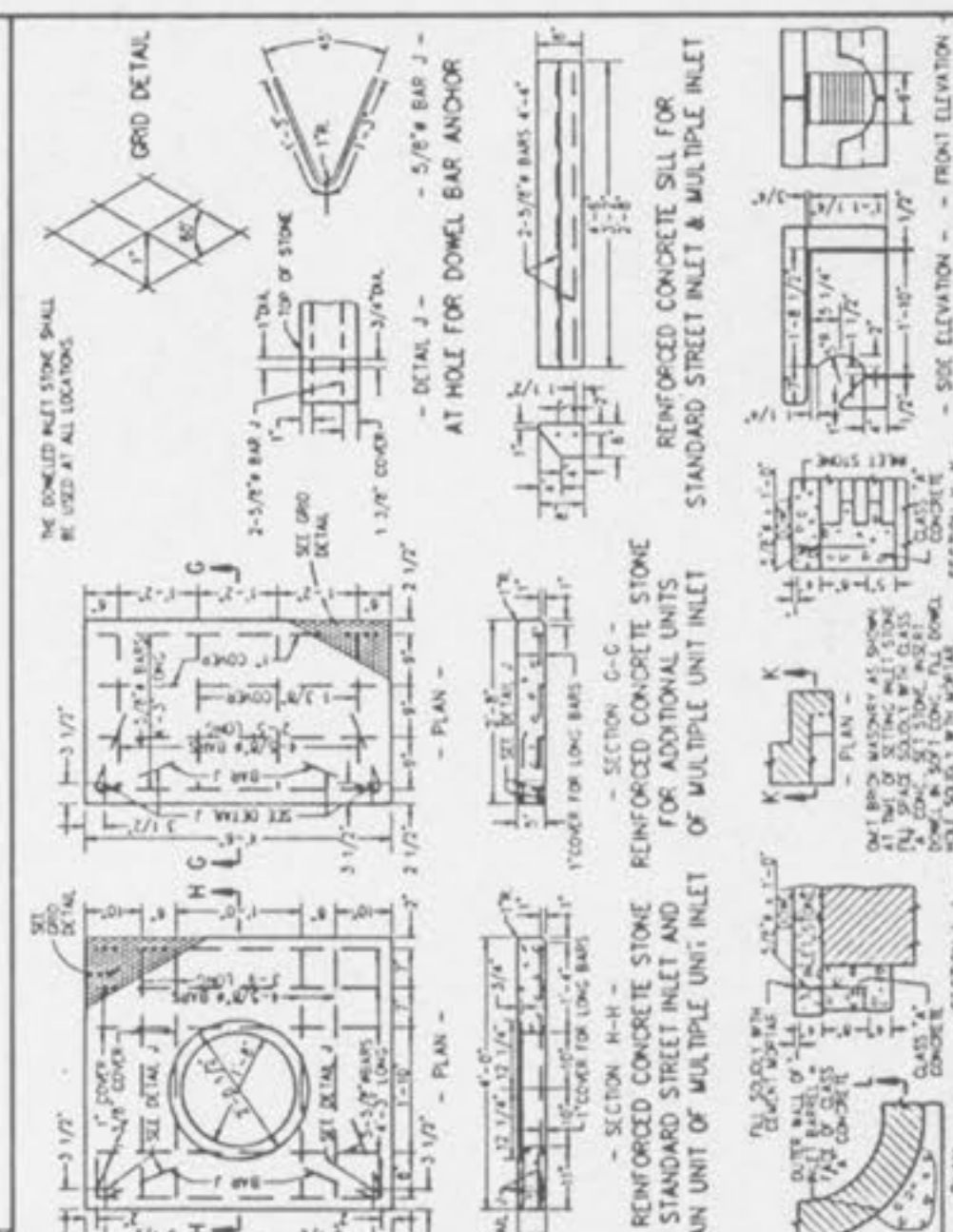

STANDARD - INLET STONES, BLOCKS & DESIGN DETAILS
 METROPOLITAN ST. LOUIS SEWER DISTRICT Standard Details of Sewer Construction
 Dr. W.S.H. Ch. J.C.K. 1992 SHEET 42

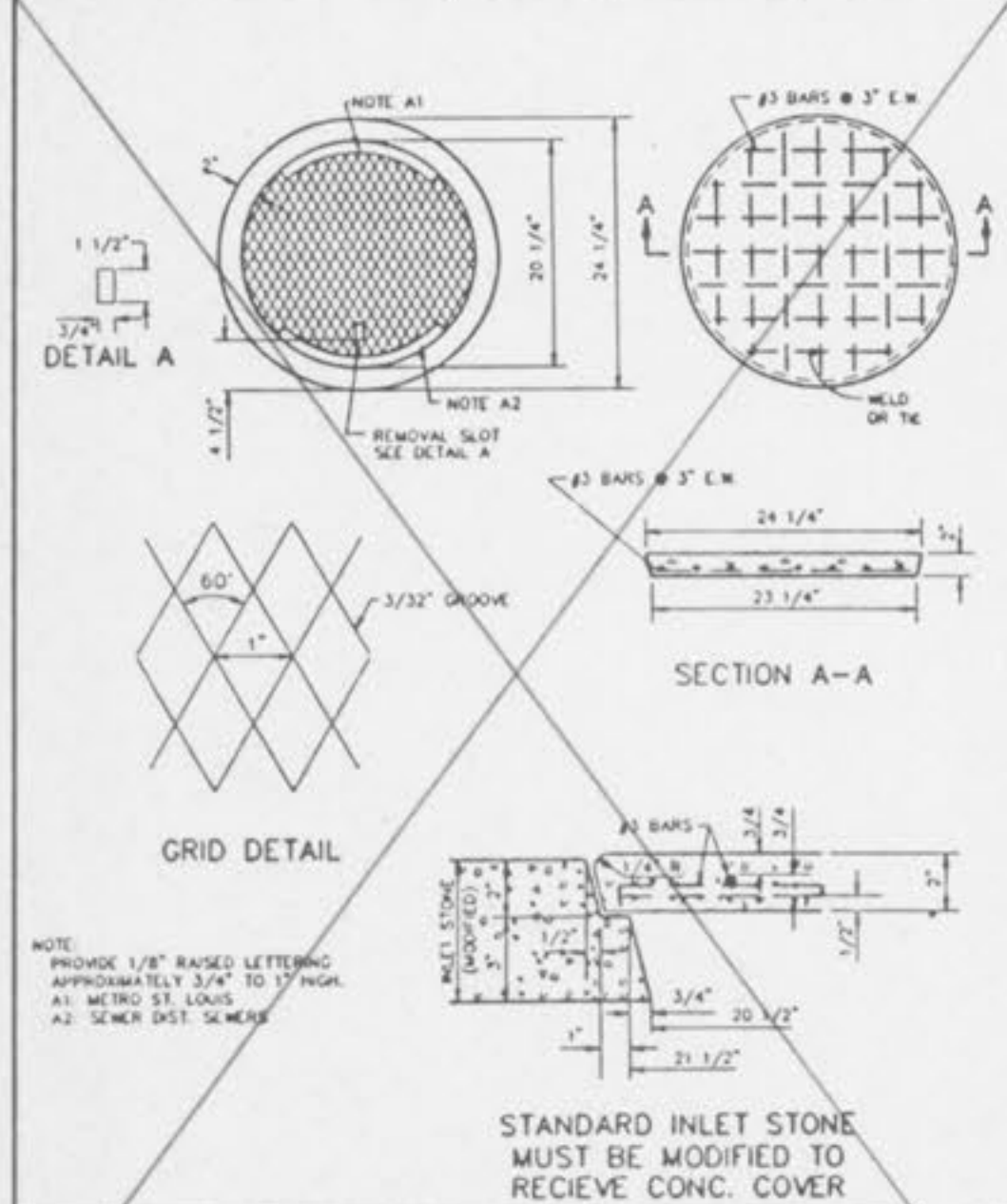

PRE-CAST CONCRETE INLET COVER
 METROPOLITAN ST. LOUIS SEWER DISTRICT Standard Details of Sewer Construction
 Dr. R.C.W. Ch. J.C.K. 1992 SHEET 43

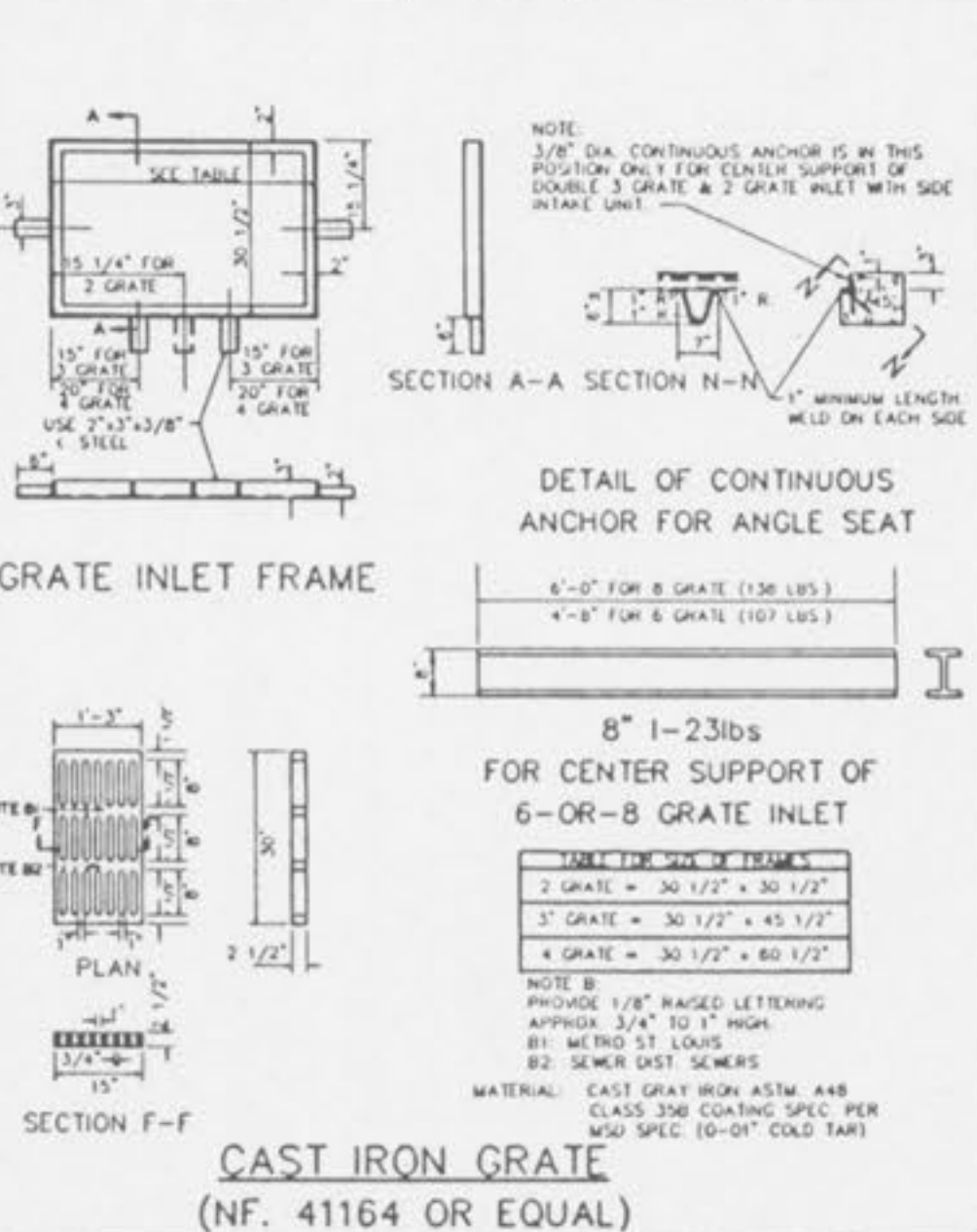

DETAILS OF INLET FRAME AND GRATES
 METROPOLITAN ST. LOUIS SEWER DISTRICT Standard Details of Sewer Construction
 Dr. R.C.W. Ch. J.C.K. 1992 SHEET 44

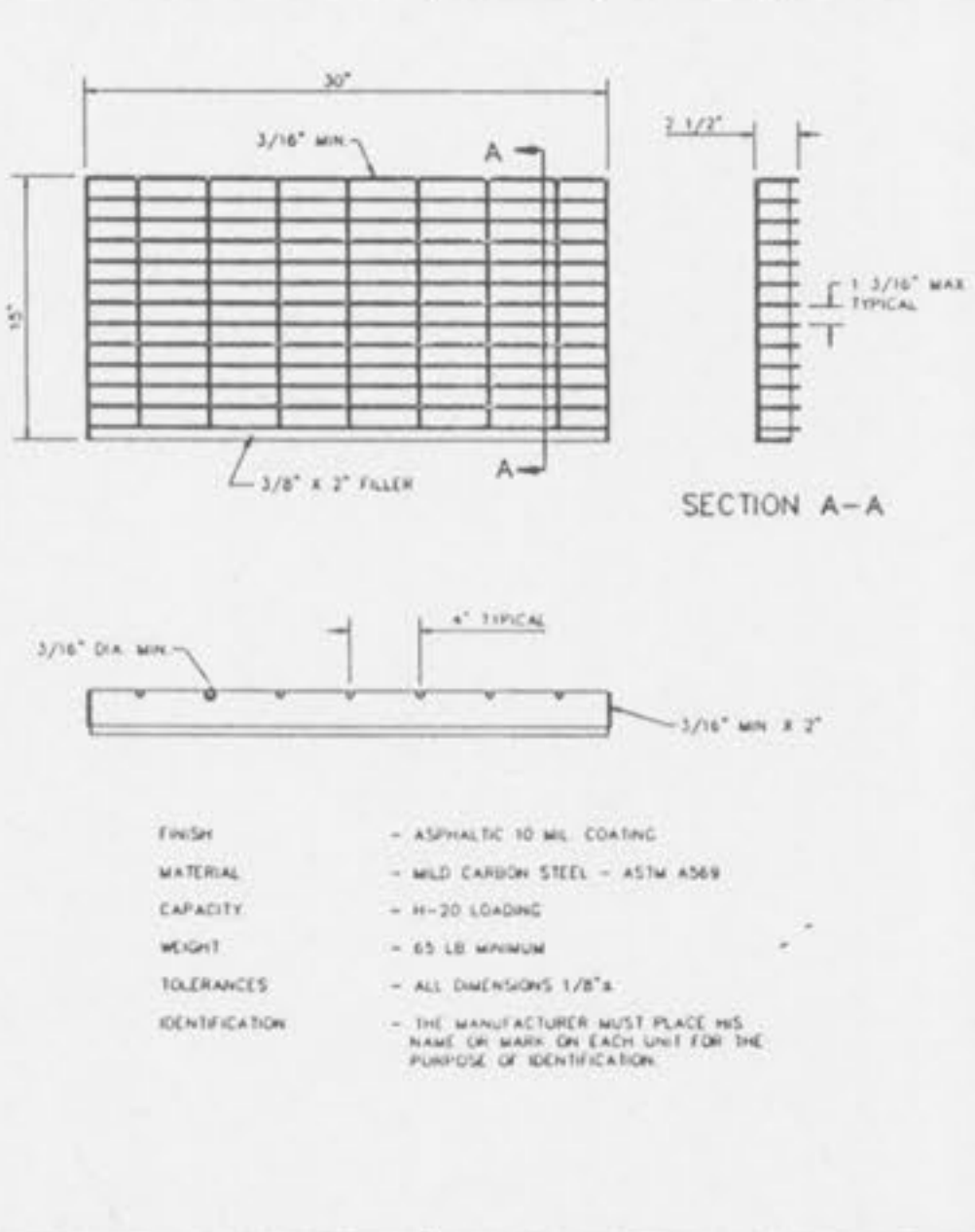

DETAIL OF STEEL GRATE
 METROPOLITAN ST. LOUIS SEWER DISTRICT Standard Details of Sewer Construction
 Dr. R.C.W. Ch. J.C.K. 1992 SHEET 45

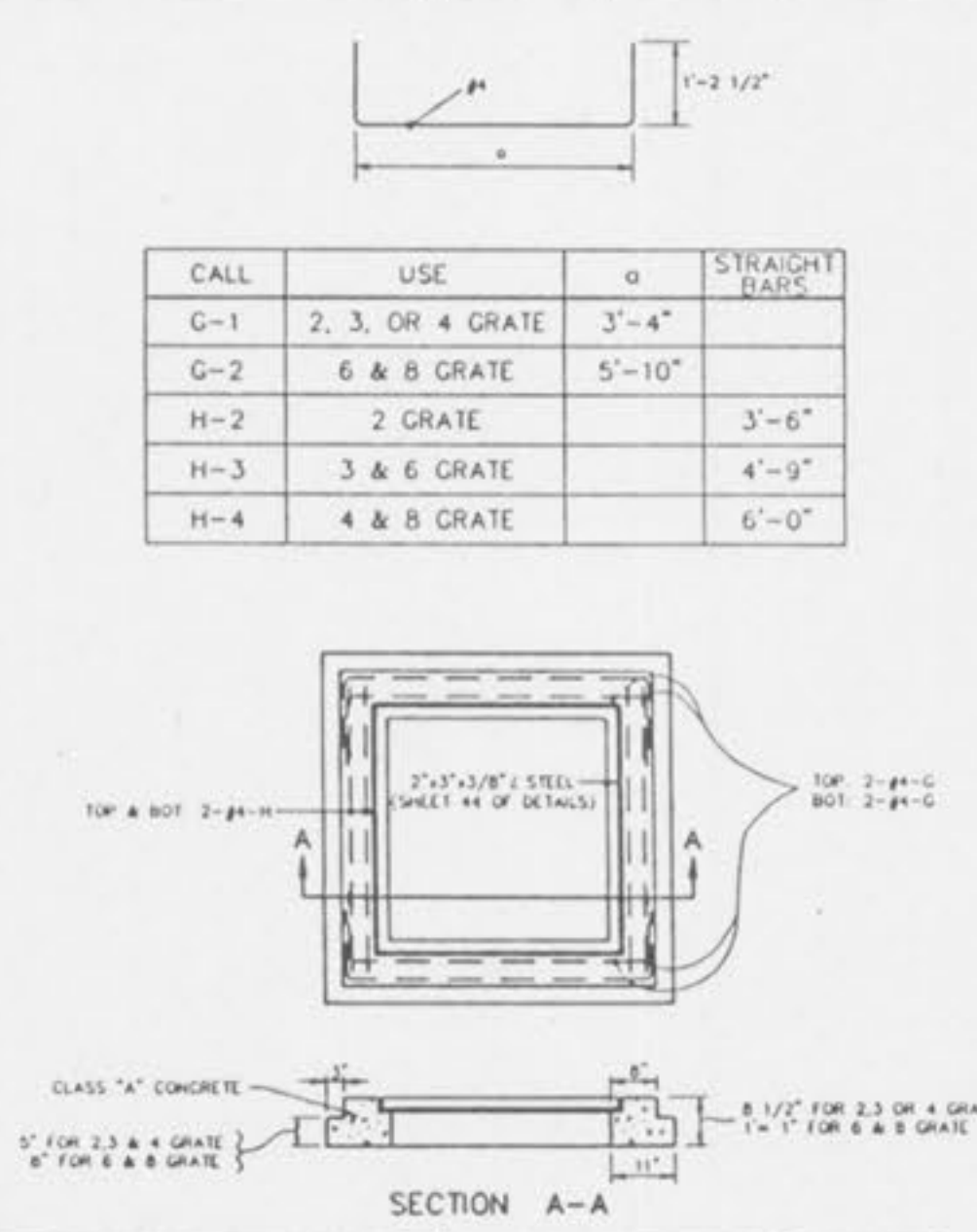

STEEL REQUIREMENTS FOR GRATE INLET SEAT
 METROPOLITAN ST. LOUIS SEWER DISTRICT Standard Details of Sewer Construction
 Dr. W.S.H. Ch. J.C.K. 1992 SHEET 46

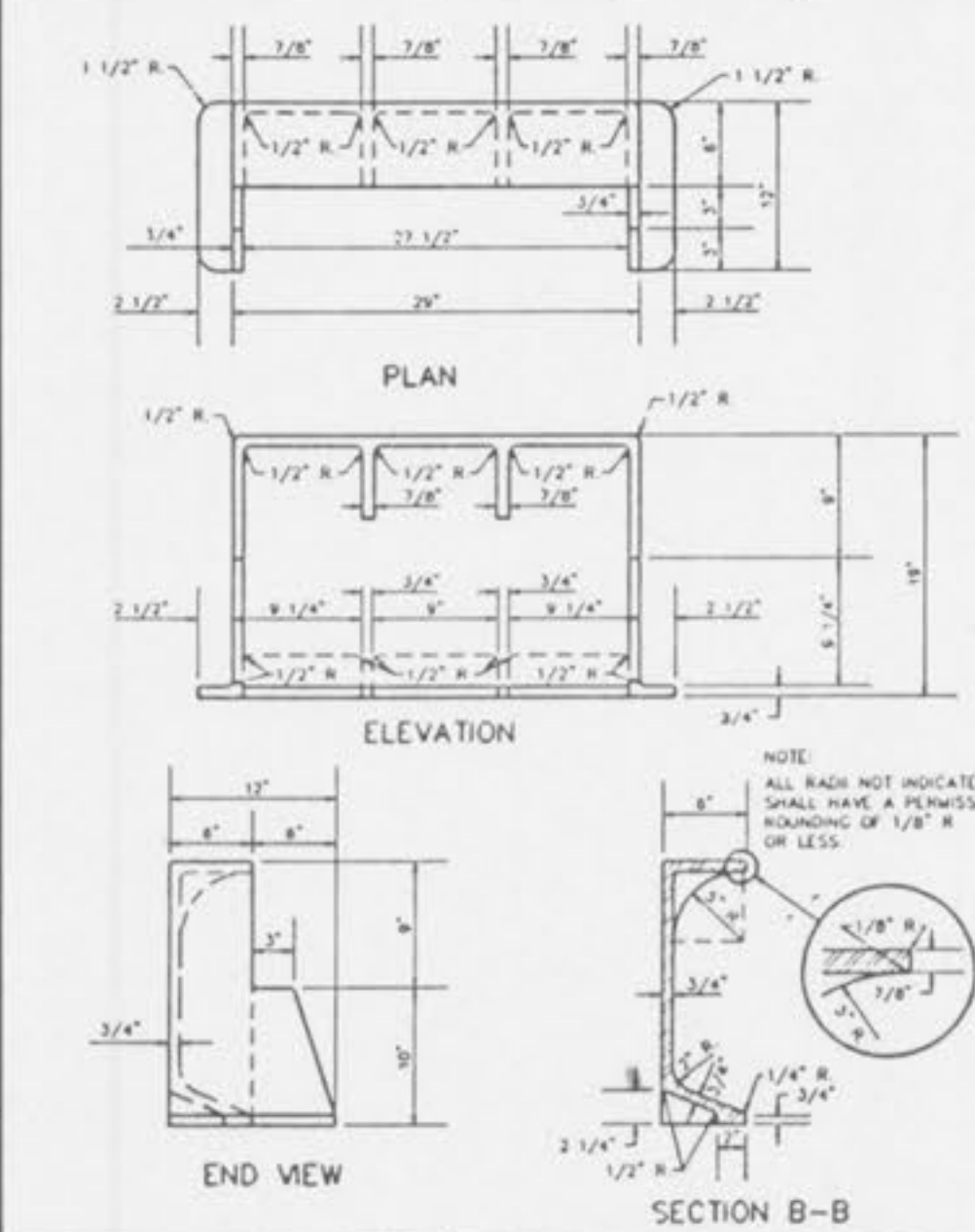

CAST IRON SIDE INTAKE UNIT FOR GRATED INLETS 249 LBS.
 METROPOLITAN ST. LOUIS SEWER DISTRICT Standard Details of Sewer Construction
 Dr. R.C.W. Ch. J.C.K. 1992 SHEET 47

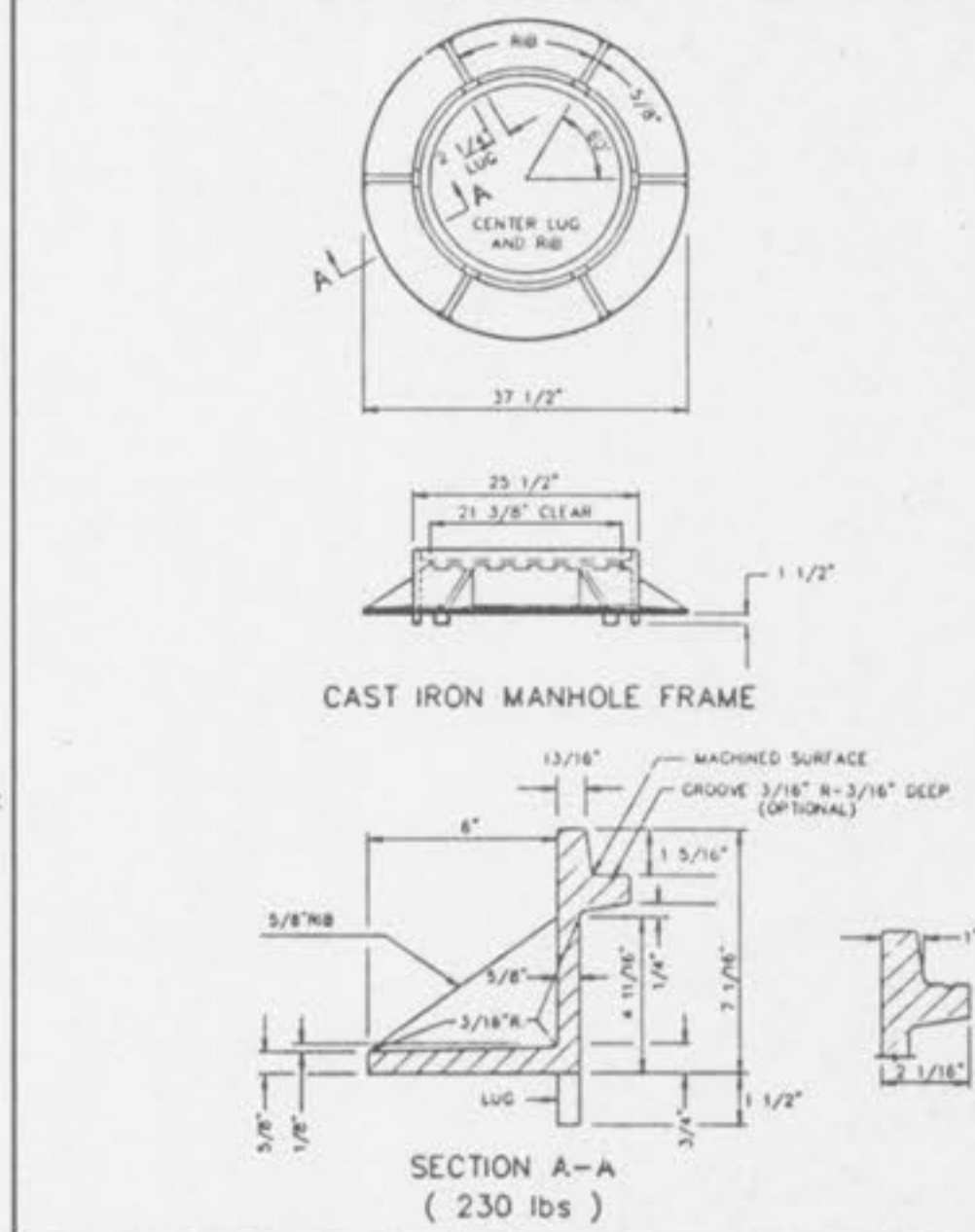

CAST IRON MANHOLE FRAME
 METROPOLITAN ST. LOUIS SEWER DISTRICT Standard Details of Sewer Construction
 Dr. D.A.B. Ch. J.C.K. 1992 SHEET 48

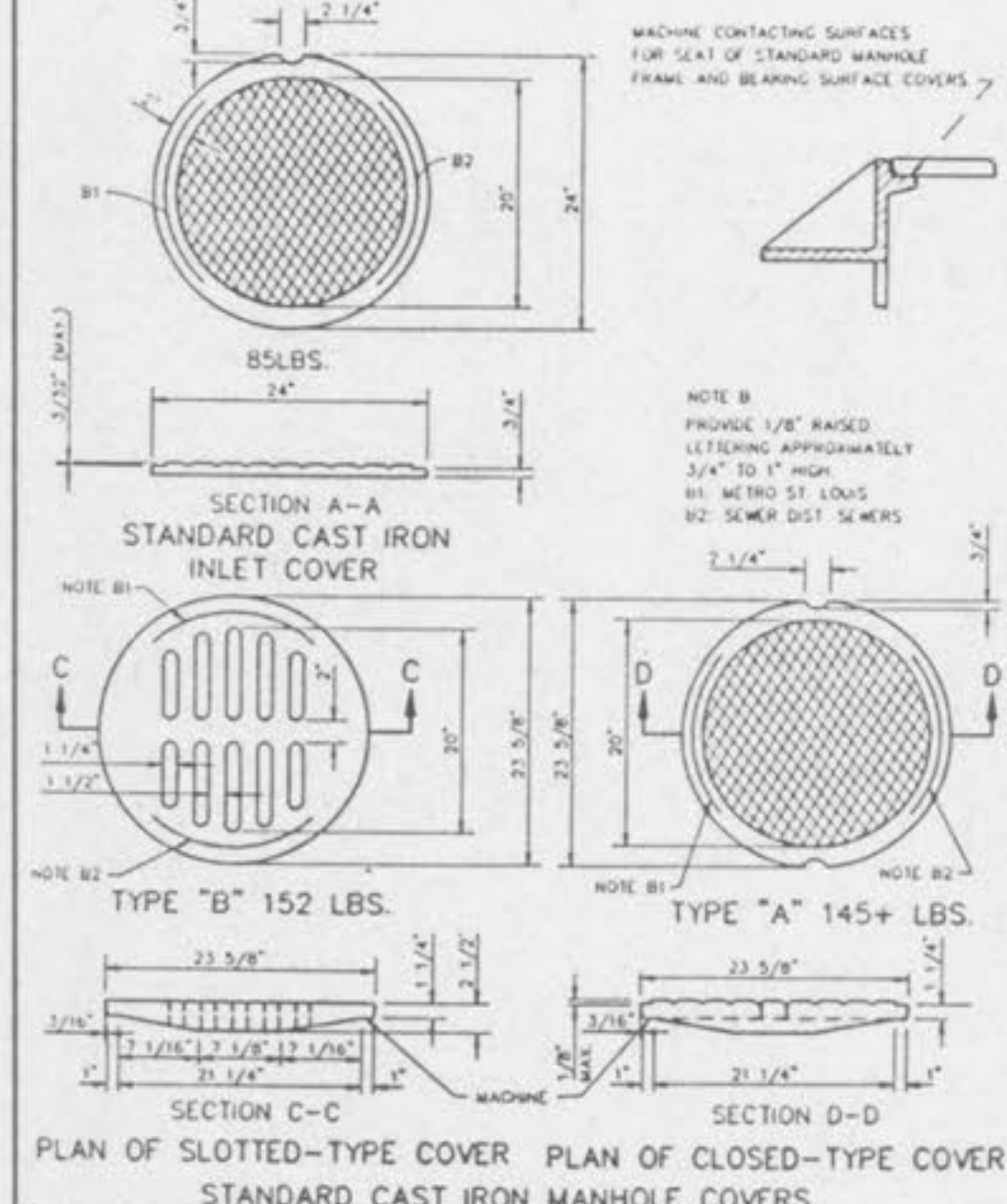

CAST IRON COVERS MANHOLES AND INLETS
 METROPOLITAN ST. LOUIS SEWER DISTRICT Standard Details of Sewer Construction
 Dr. R.C.W. Ch. J.C.K. 1992 SHEET 49

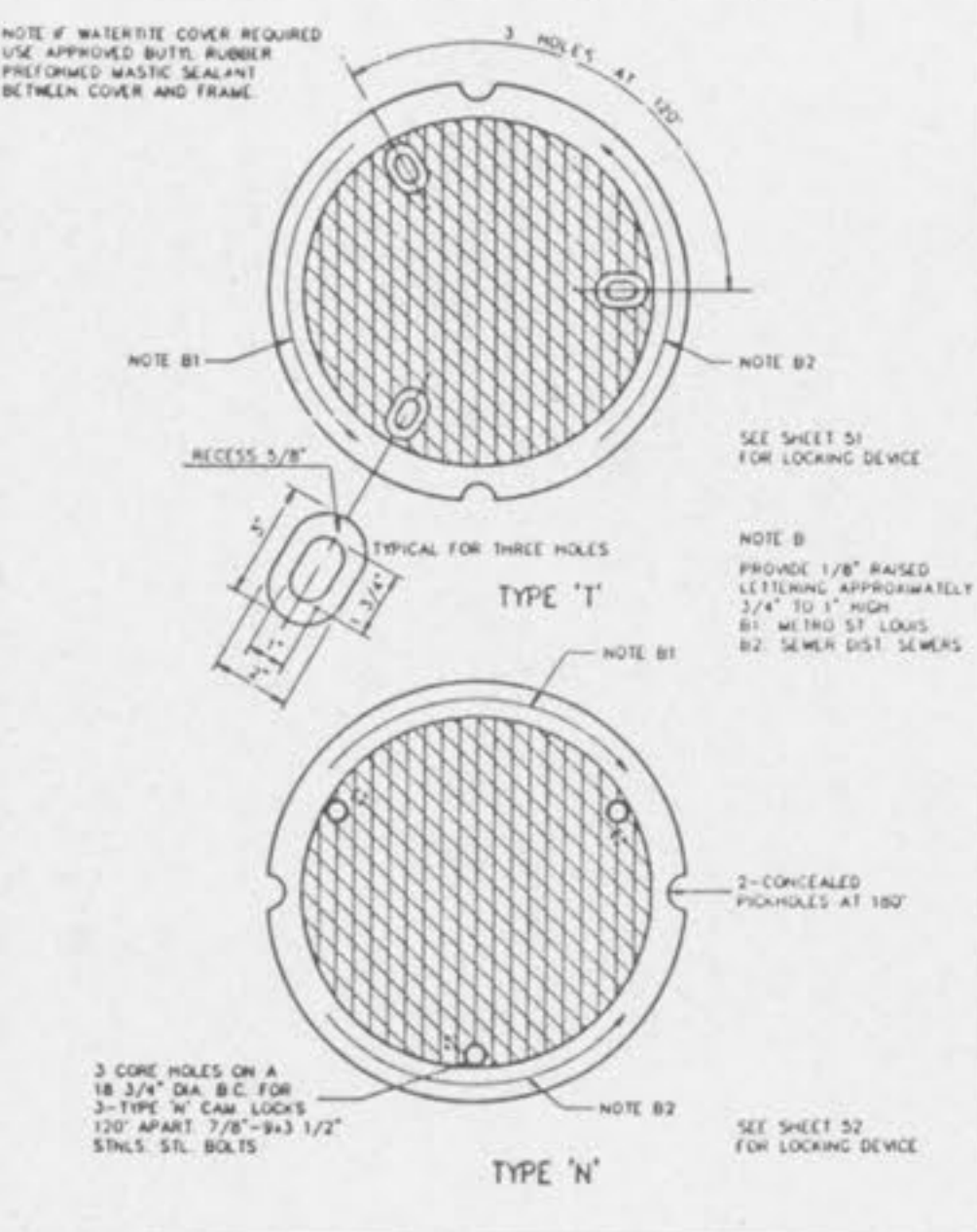

CAST IRON MANHOLE COVERS (LOCK TYPE)
 METROPOLITAN ST. LOUIS SEWER DISTRICT Standard Details of Sewer Construction
 Dr. W.S.H. Ch. J.C.K. 1992 SHEET 50

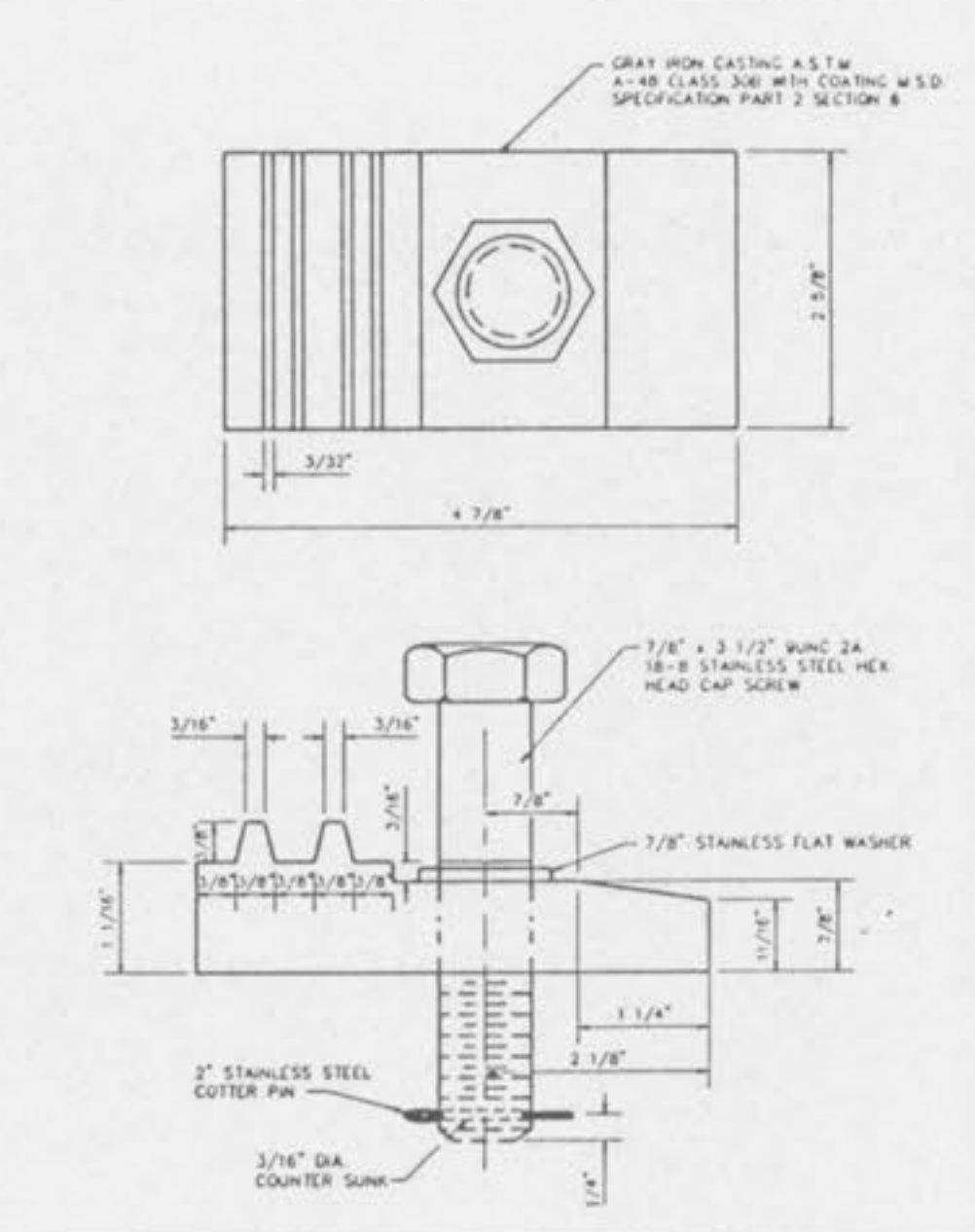

LOCKING DEVICE FOR TYPE 'I' LOCK TYPE MANHOLE COVER
 METROPOLITAN ST. LOUIS SEWER DISTRICT Standard Details of Sewer Construction
 Dr. W.S.H. Ch. J.C.K. 1992 SHEET 51

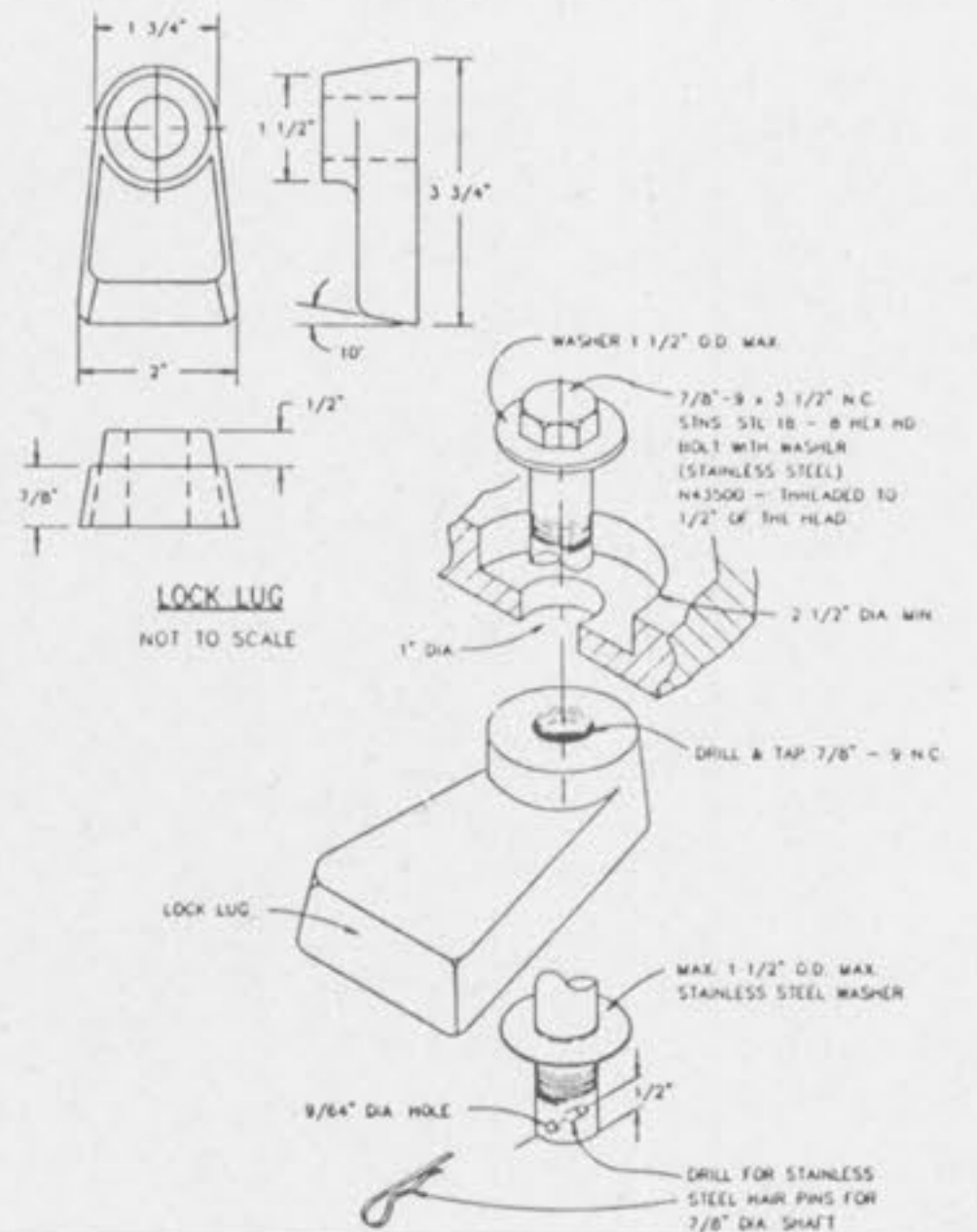

LOCKING DEVICE FOR TYPE 'N' LOCK TYPE MANHOLE COVER
 METROPOLITAN ST. LOUIS SEWER DISTRICT Standard Details of Sewer Construction
 Dr. J.L.G. Ch. J.C.K. 1992 SHEET 52

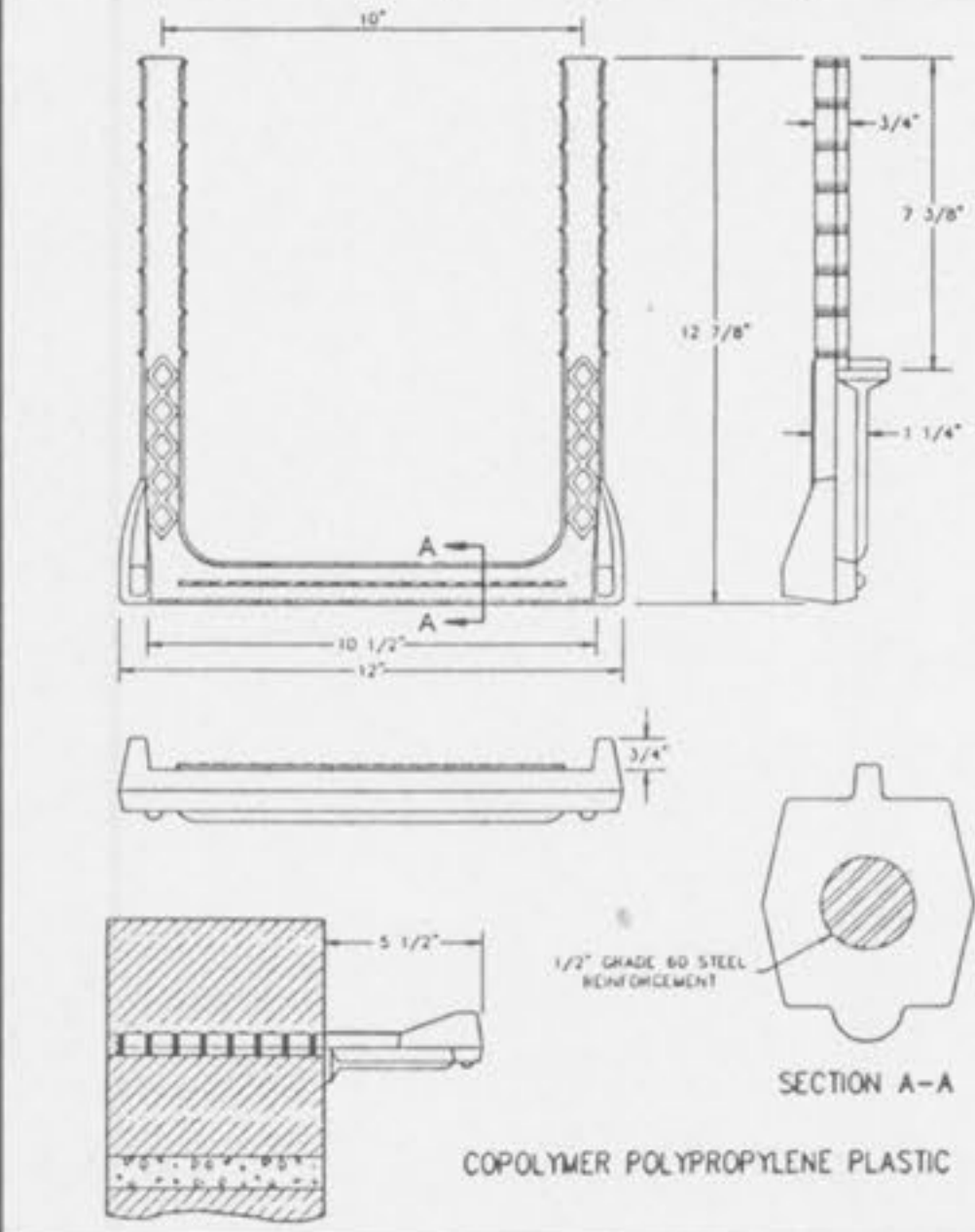

PSI-B MANHOLE STEP INTO JOINT
 METROPOLITAN ST. LOUIS SEWER DISTRICT Standard Details of Sewer Construction
 Dr. W.S.H. Ch. J.C.K. 1992 SHEET 53

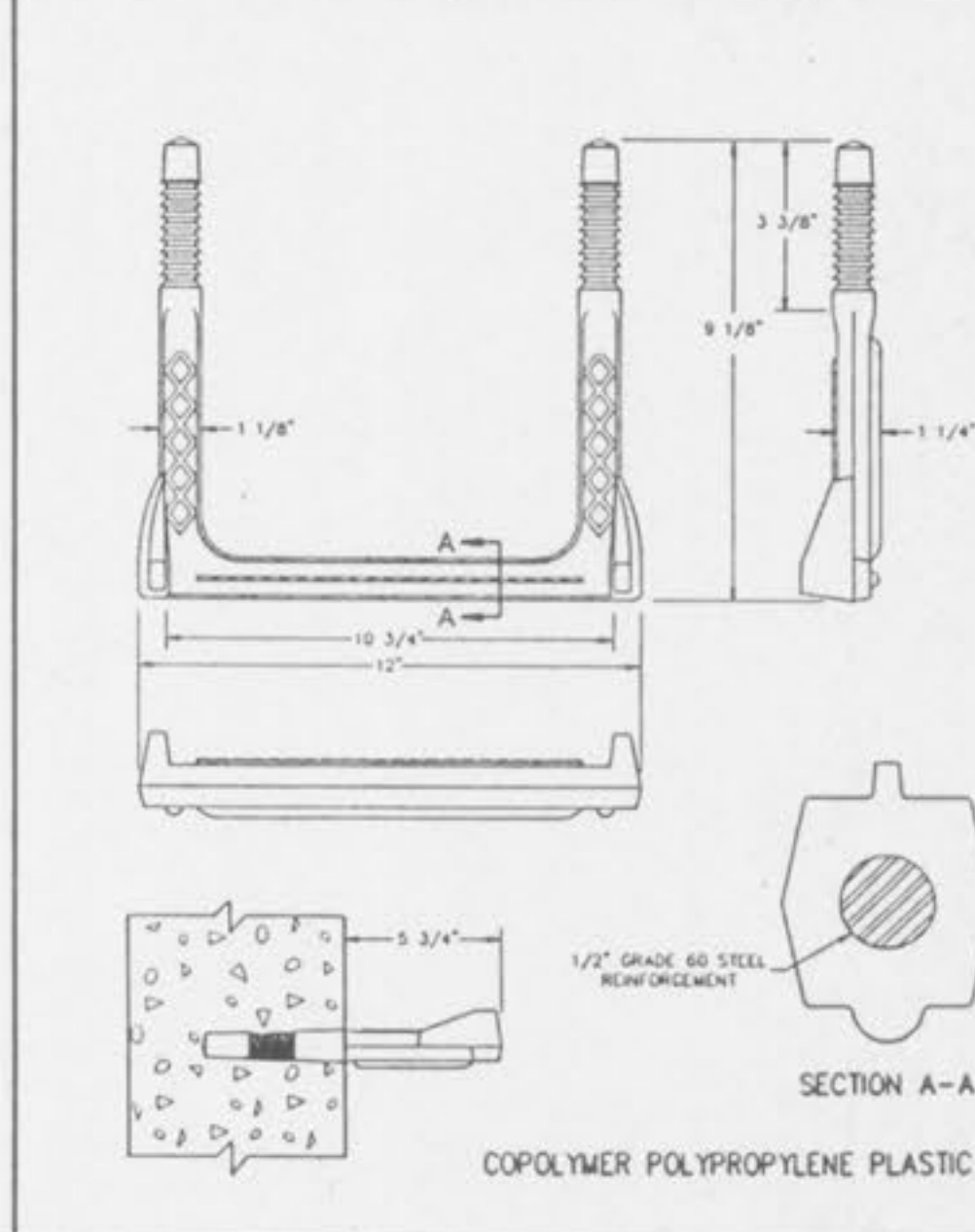

MANHOLE STEP FOR PRECAST MANHOLE
 METROPOLITAN ST. LOUIS SEWER DISTRICT Standard Details of Sewer Construction
 Dr. D.A.B. Ch. J.C.K. 1992 SHEET 54