

GUTTER SUMPS FOR VERTICAL CURB	METROPOLITAN ST. LOUIS SEWER DISTRICT Standard Details of Sewer Construction	Dr. W.S.H. Ch. J.C.K.	1992	SHEET 55
--------------------------------	---------------------------------------------------------------------------------	--------------------------	------	----------

GUTTER SUMP FOR LIP CURB	METROPOLITAN ST. LOUIS SEWER DISTRICT Standard Details of Sewer Construction	Dr. R.G.W. Ch. J.C.K.	1992	SHEET 56
--------------------------	---------------------------------------------------------------------------------	--------------------------	------	----------

FLARED END SECTION	METROPOLITAN ST. LOUIS SEWER DISTRICT Standard Details of Sewer Construction	Dr. W.S.H. Ch. J.C.K.	1992	SHEET 57
--------------------	---------------------------------------------------------------------------------	--------------------------	------	----------

STORMWATER CHANNELS	METROPOLITAN ST. LOUIS SEWER DISTRICT Standard Details of Sewer Construction	Dr. R.G.W. Ch. J.C.K.	1992	SHEET 58
---------------------	---------------------------------------------------------------------------------	--------------------------	------	----------

HOUSE CONNECTION TO EXISTING TEE OR WYE	METROPOLITAN ST. LOUIS SEWER DISTRICT Standard Details of Sewer Construction	Dr. D.A.B. Ch. J.C.K.	1992	SHEET 59
-----------------------------------------	---------------------------------------------------------------------------------	--------------------------	------	----------

MACHINE TAP	METROPOLITAN ST. LOUIS SEWER DISTRICT Standard Details of Sewer Construction	Dr. W.S.H. Ch. J.C.K.	1992	SHEET 60
-------------	---------------------------------------------------------------------------------	--------------------------	------	----------

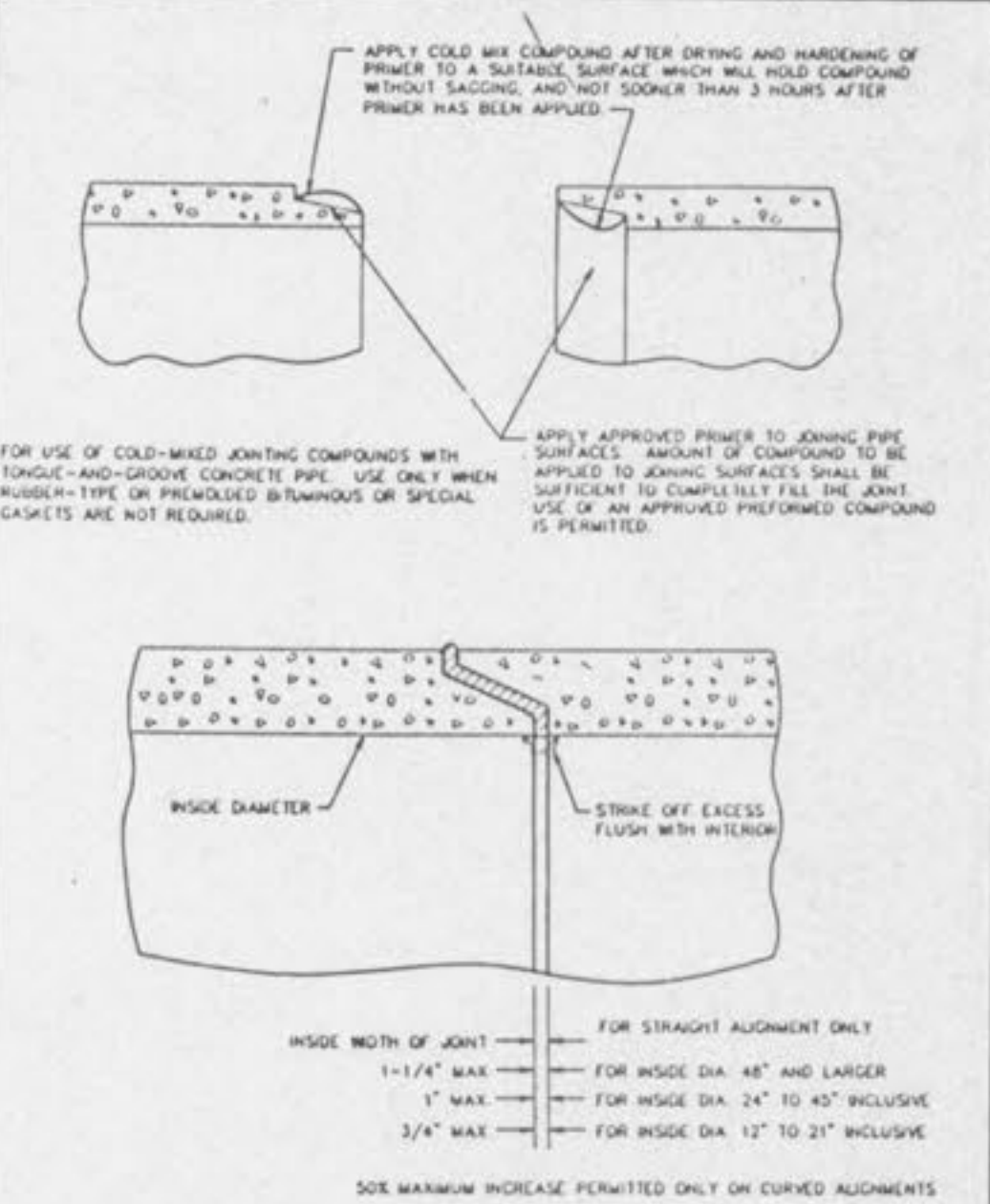
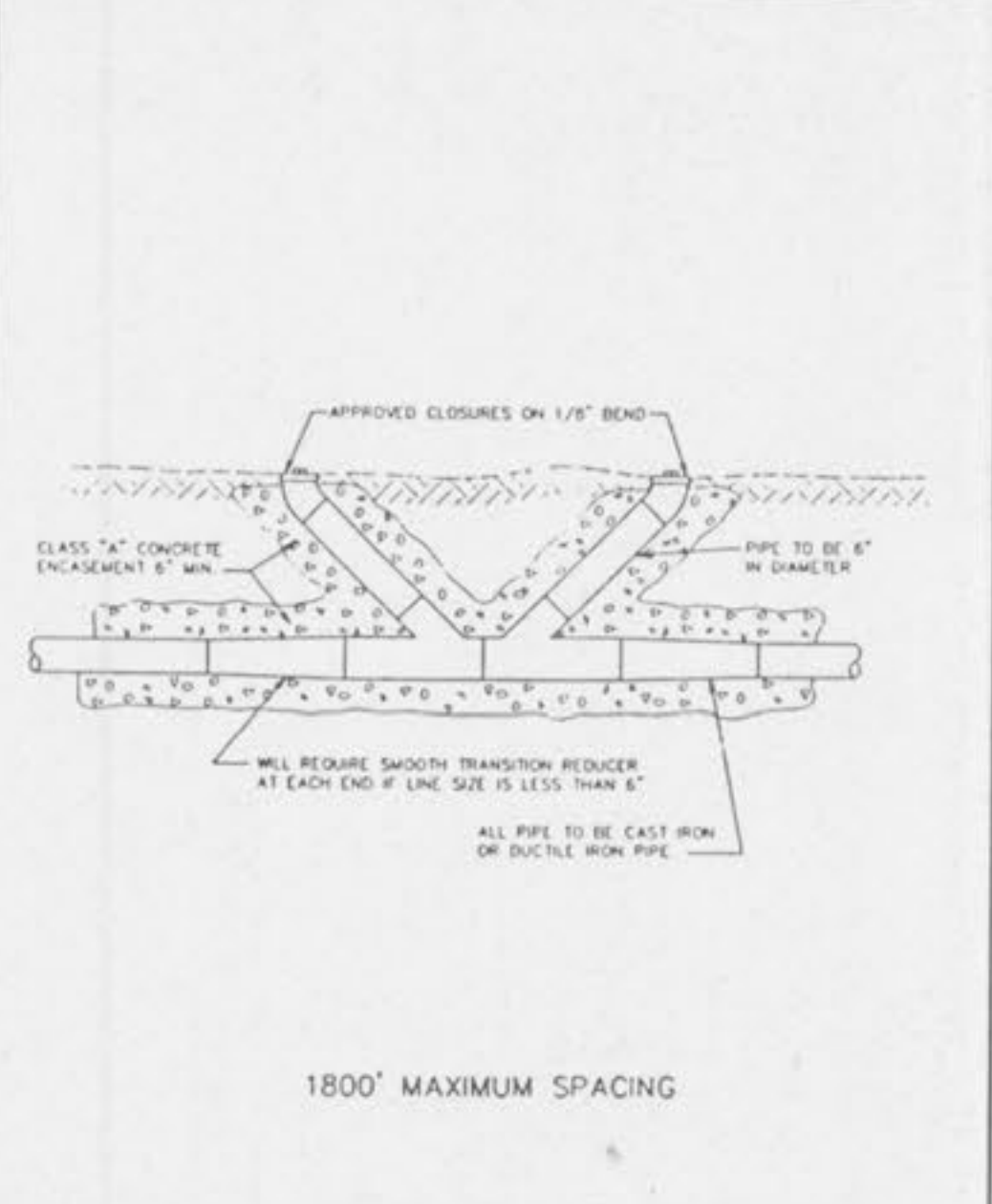
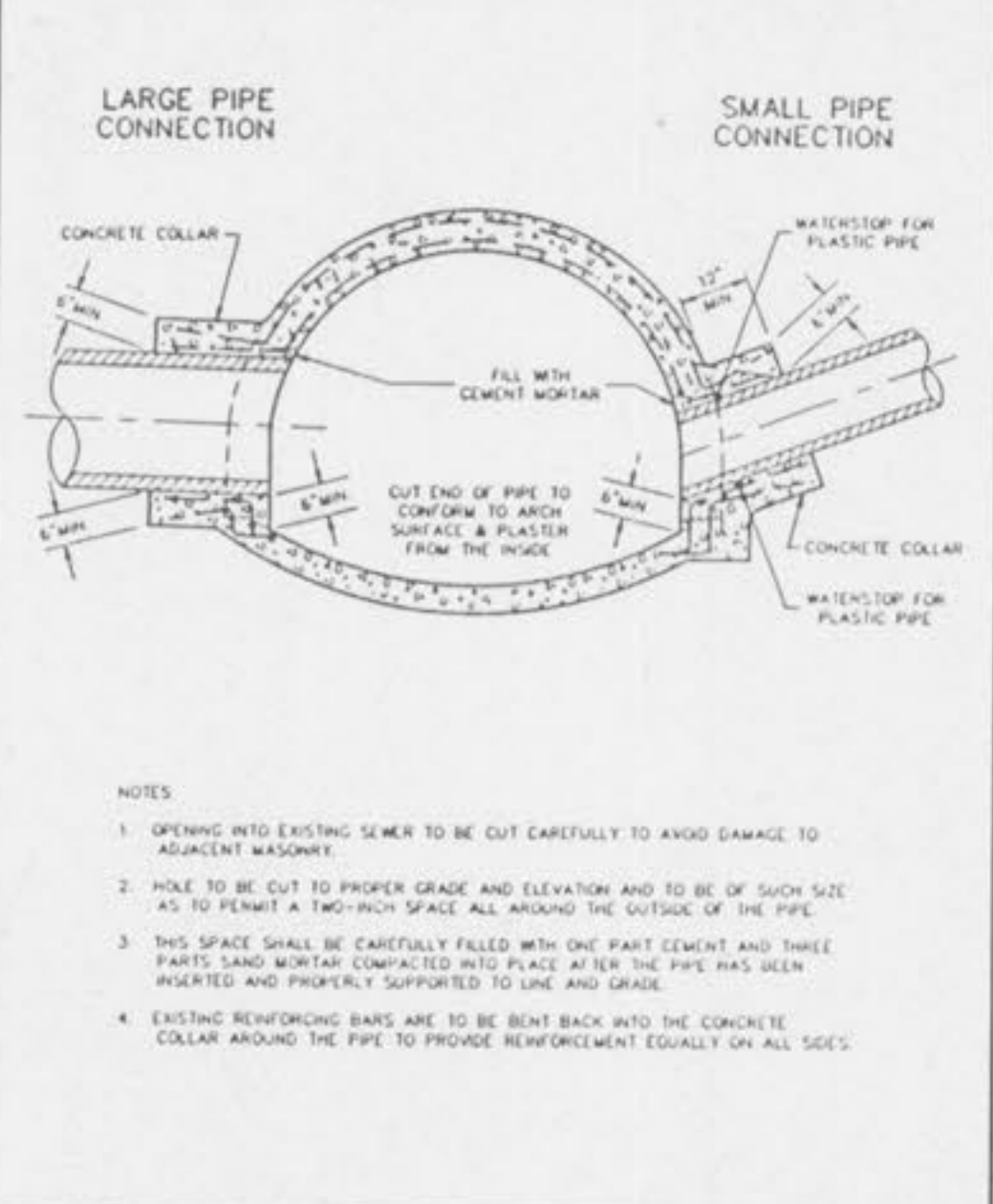
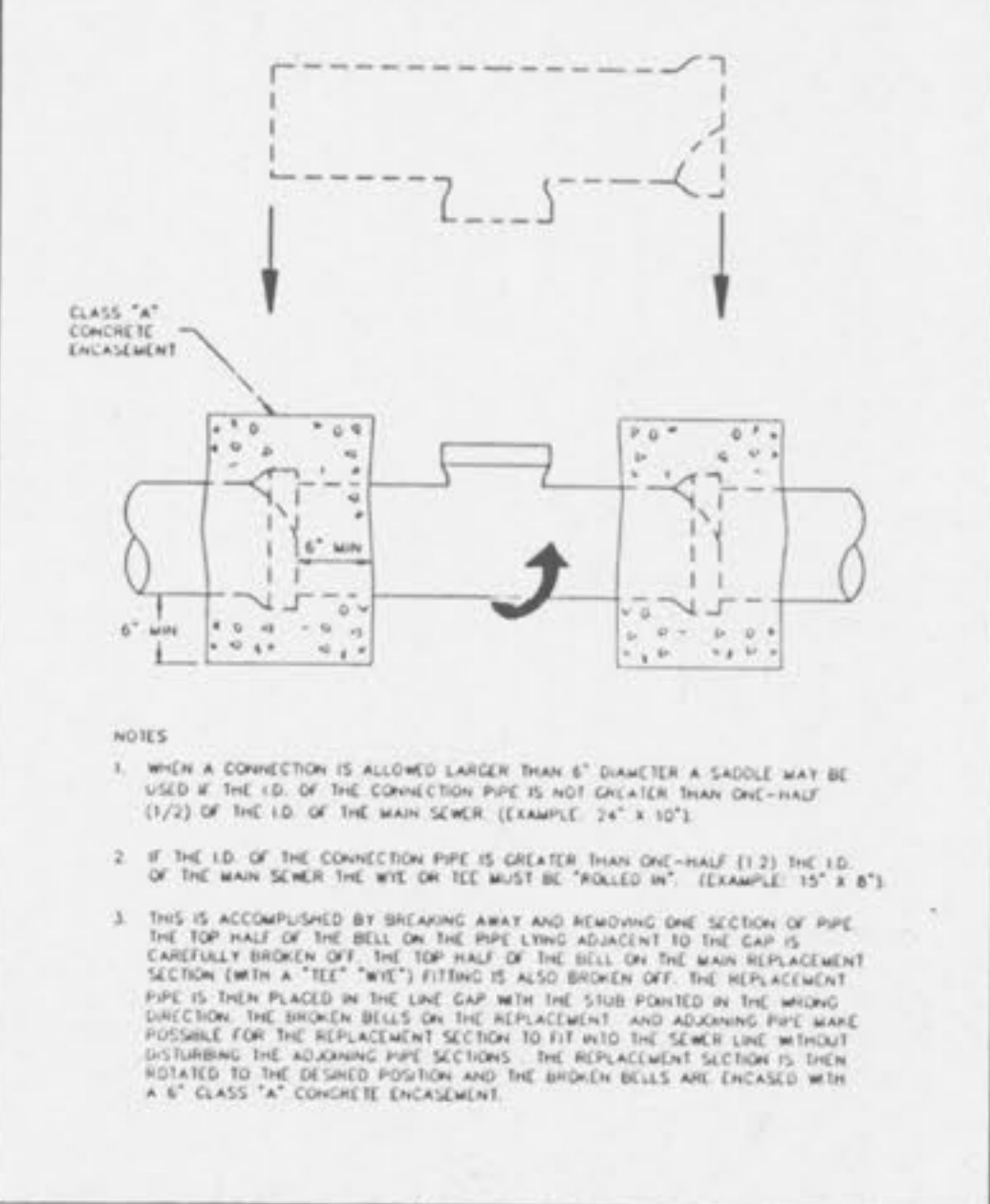
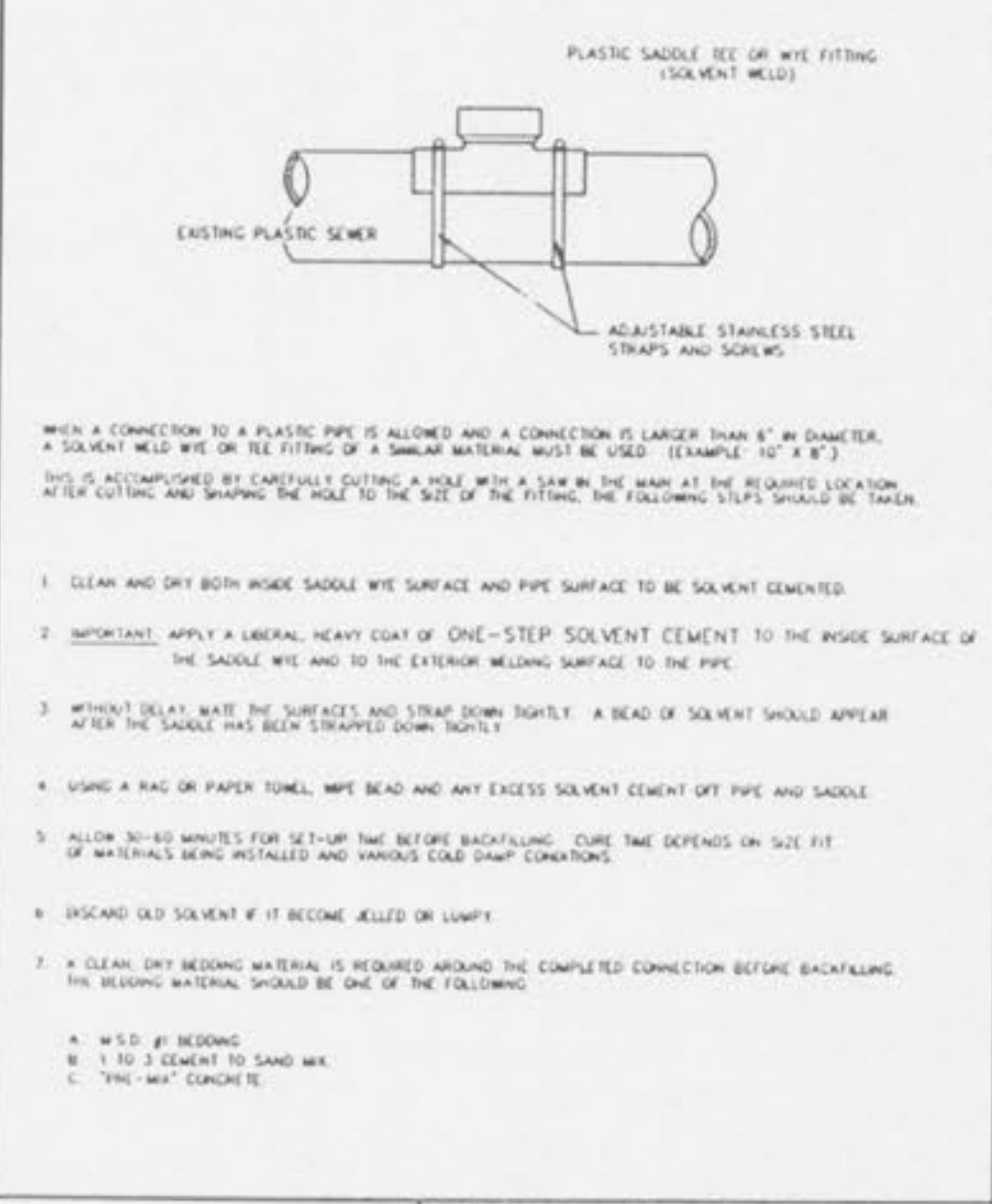
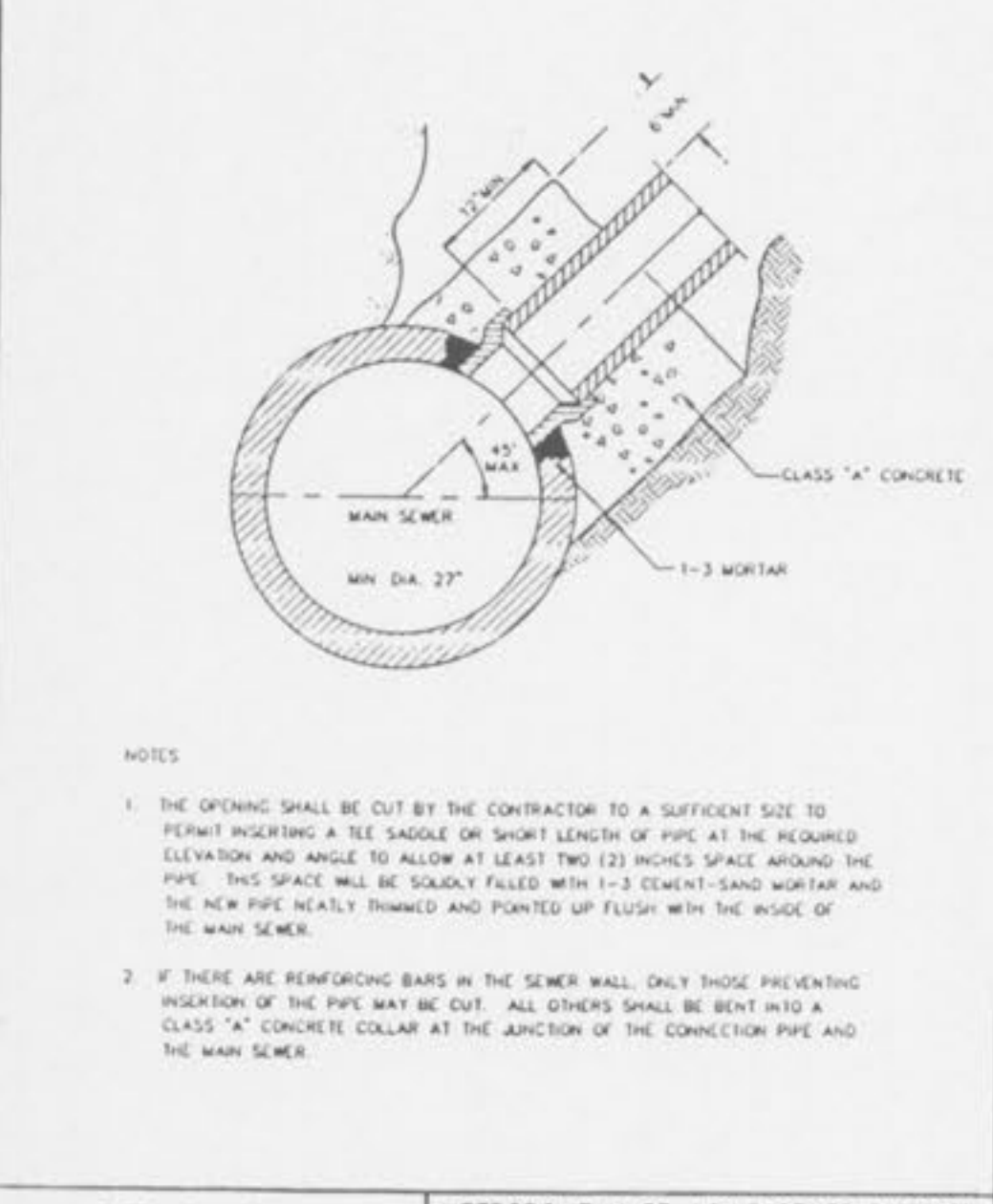

HOUSE CONNECTIONS ALLOWED BY TEE SADDLE	METROPOLITAN ST. LOUIS SEWER DISTRICT Standard Details of Sewer Construction	Dr. D.A.B. Ch. J.C.K.	1992	SHEET 61
-----------------------------------------	---------------------------------------------------------------------------------	--------------------------	------	----------

8\"/>
-------

"ROLL-IN" (FOR EXISTING CLAY OR CONCRETE PIPE)	METROPOLITAN ST. LOUIS SEWER DISTRICT Standard Details of Sewer Construction	Dr. D.A.B. Ch. J.C.K.	1992	SHEET 63
------------------------------------------------	---------------------------------------------------------------------------------	--------------------------	------	----------

CONNECTIONS TO LARGE SEWERS	METROPOLITAN ST. LOUIS SEWER DISTRICT Standard Details of Sewer Construction	Dr. W.S.H. Ch. J.C.K.	1992	SHEET 64
-----------------------------	---------------------------------------------------------------------------------	--------------------------	------	----------

FORCE MAIN CLEANOUT (6\"/>
----------------------------

TONGUE AND GROOVE CONCRETE PIPE JOINTS	METROPOLITAN ST. LOUIS SEWER DISTRICT Standard Details of Sewer Construction	Dr. D.A.B. Ch. J.C.K.	1992	SHEET 66
----------------------------------------	---------------------------------------------------------------------------------	--------------------------	------	----------

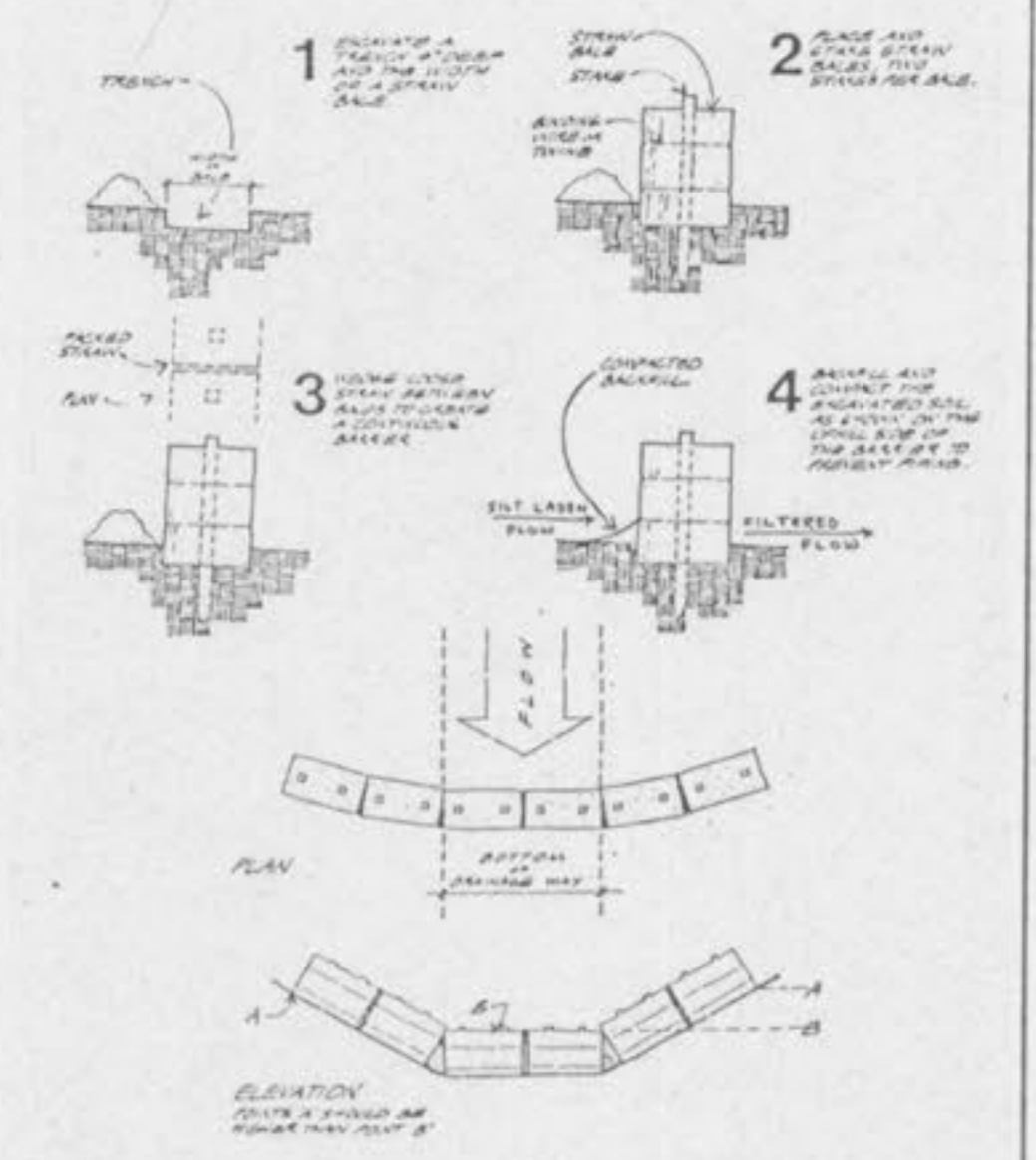
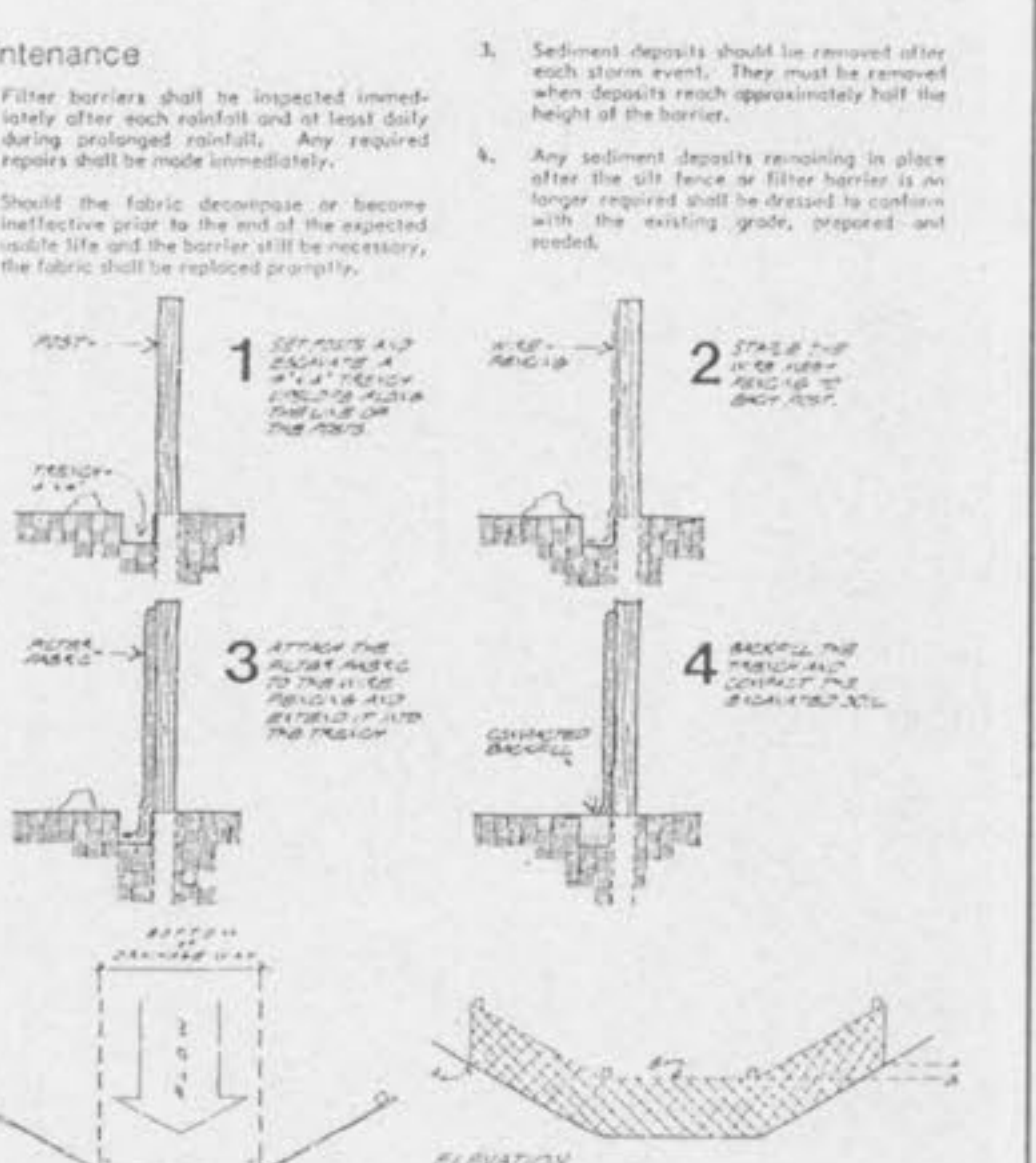
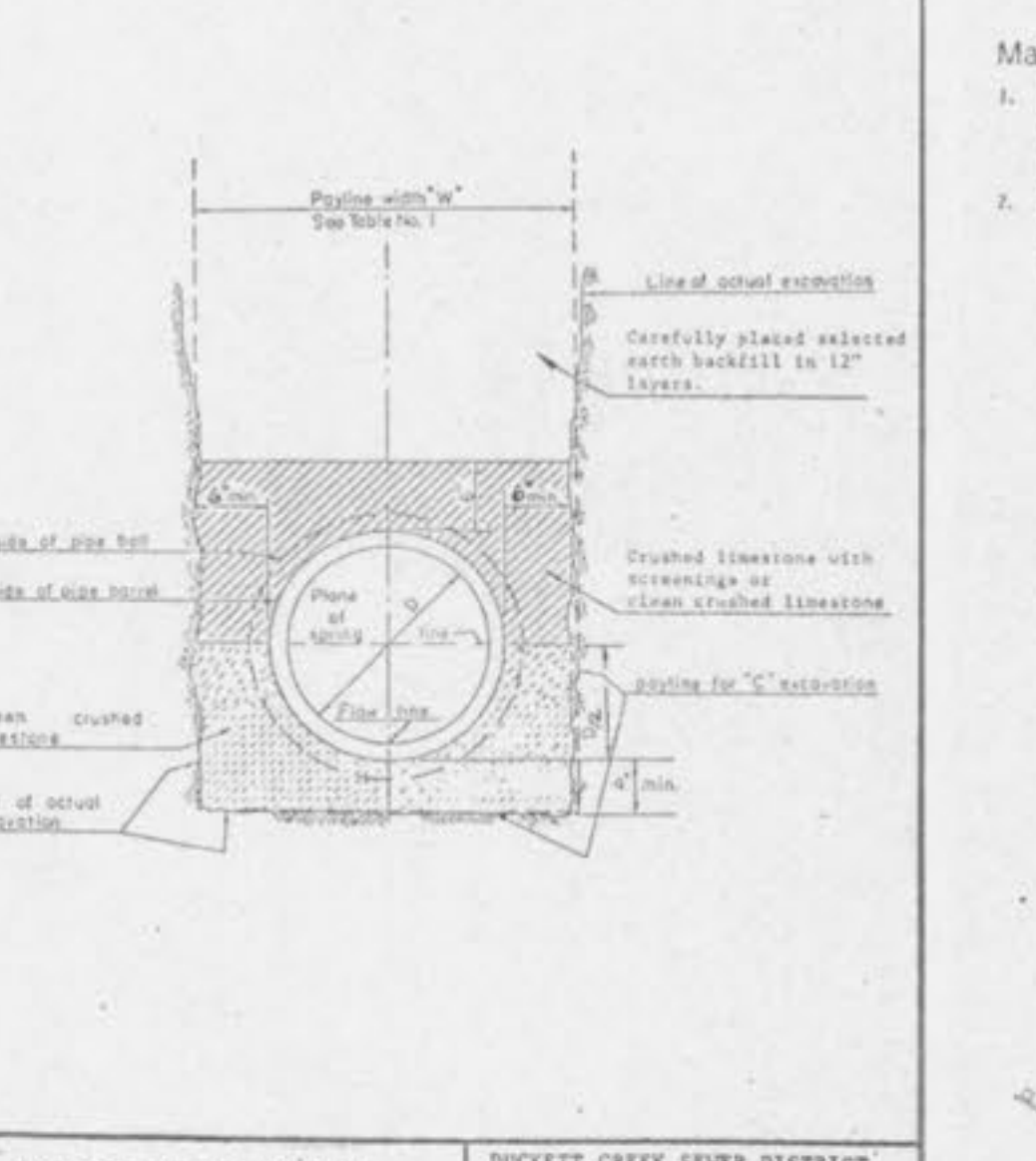
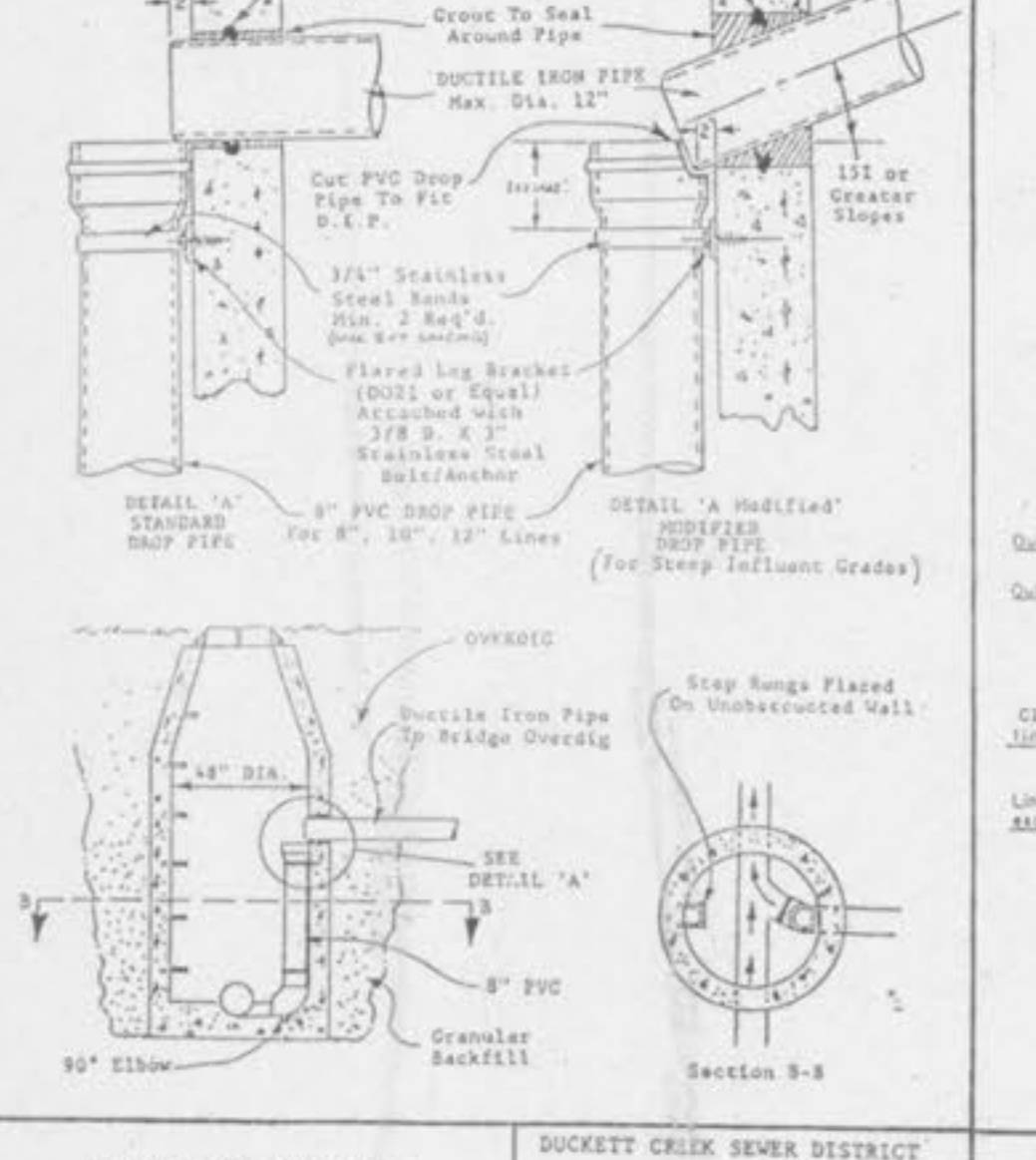

INSIDE DROP MANHOLE	BUCKETT CREEK SEWER DISTRICT STANDARD CONSTRUCTION DETAIL DETAIL NO. JAN. 1989
---------------------	--------------------------------------------------------------------------------------

PIPE BEDDING CLASS 'C' (FOR ALL PIPE EXCEPT REINFORCED CONCRETE PIPE)	BUCKETT CREEK SEWER DISTRICT STANDARD CONSTRUCTION DETAIL DETAIL NO. JAN. 1989
-----------------------------------------------------------------------	--------------------------------------------------------------------------------------

Maintenance	BUCKETT CREEK SEWER DISTRICT STANDARD CONSTRUCTION DETAIL DETAIL NO. JAN. 1989
-------------	--------------------------------------------------------------------------------------

Placement and Construction of a Straw Bale Barrier	BUCKETT CREEK SEWER DISTRICT STANDARD CONSTRUCTION DETAIL DETAIL NO. JAN. 1989
----------------------------------------------------	--------------------------------------------------------------------------------------

FORCE MAIN CLEANOUT (6\"/>
----------------------------

TONGUE AND GROOVE CONCRETE PIPE JOINTS	METROPOLITAN ST. LOUIS SEWER DISTRICT Standard Details of Sewer Construction	Dr. D.A.B. Ch. J.C.K.	1992	SHEET 66
----------------------------------------	---------------------------------------------------------------------------------	--------------------------	------	----------