

ROUND PIPE				HORIZONTAL ELLIPTICAL PIPE			
INSIDE DIAMETER OF PIPE (INCHES)	"W" PAYLINE WIDTH OF TRENCH (FEET)	"M" PAYLINE WIDTH OF TRENCH (INCHES)	PAY-VOLUMES (CU. FT. PER FT.)	INSIDE DIMENSIONS OF PIPE (INCHES)	"W" PAYLINE WIDTH OF TRENCH (FEET)	"M" PAYLINE WIDTH OF TRENCH (INCHES)	PAY-VOLUMES (CU. FT. PER FT.)
8	30	2.50	3.38				
10	30	2.50	3.58				
12	30	2.50	3.87				
15	30	2.50	4.09				
18	30	2.50	4.25				
21	36	3.00	5.77	14 x 23	41	3.42	5.94
24	42	3.50	7.39	18 x 30	49	4.08	7.88
27	45	3.75	8.18	22 x 34	53	4.42	8.61
30	48	4.00	9.30	24 x 38	58	4.83	9.70
33	53	4.42	10.53	27 x 42	62	5.17	10.71
36	56	4.67	11.43	29 x 45	66	5.50	11.72
39							
42	63	5.25	13.38	34 x 53	75	6.25	14.05
48	70	5.83	15.67	36 x 60	83	6.92	16.18
54	77	6.42	18.15	43 x 68	92	7.87	18.81
60	84	7.00	20.73	48 x 76	101	8.42	21.59
66	91	7.58	23.45	53 x 83	109	9.08	24.35
72	98	8.17	26.37	58 x 91	118	9.83	27.45
78	105	8.75	29.39	63 x 98	128	10.50	30.50
84	112	9.33	32.57	68 x 106	135	11.25	33.61
90	119	9.92	35.90	72 x 113	143	11.92	36.99
96	126	10.50	39.37	77 x 121	152	12.67	40.69
102	133	11.08	42.99	82 x 128	160	13.33	44.45
108	140	11.67	46.75	87 x 136	168	14.00	47.79
114	147	12.25	50.66	92 x 143	176	14.67	51.70
120	154	12.83	54.72	97 x 151	185	15.42	56.01
126	161	13.42	58.92				
132	168	14.00	63.27	106 x 166	202	16.83	64.48
144	182	15.17	72.40	116 x 180	218	18.17	73.59

TABLE 1
PAYLINE WIDTHS OF TRENCH AND PAY-VOLUMES OF CONCRETE
METROPOLITAN ST. LOUIS SEWER DISTRICT
Standard Details of Sewer Construction
Dr. R.C.W. Ch. J.C.K. 1992 SHEET 1

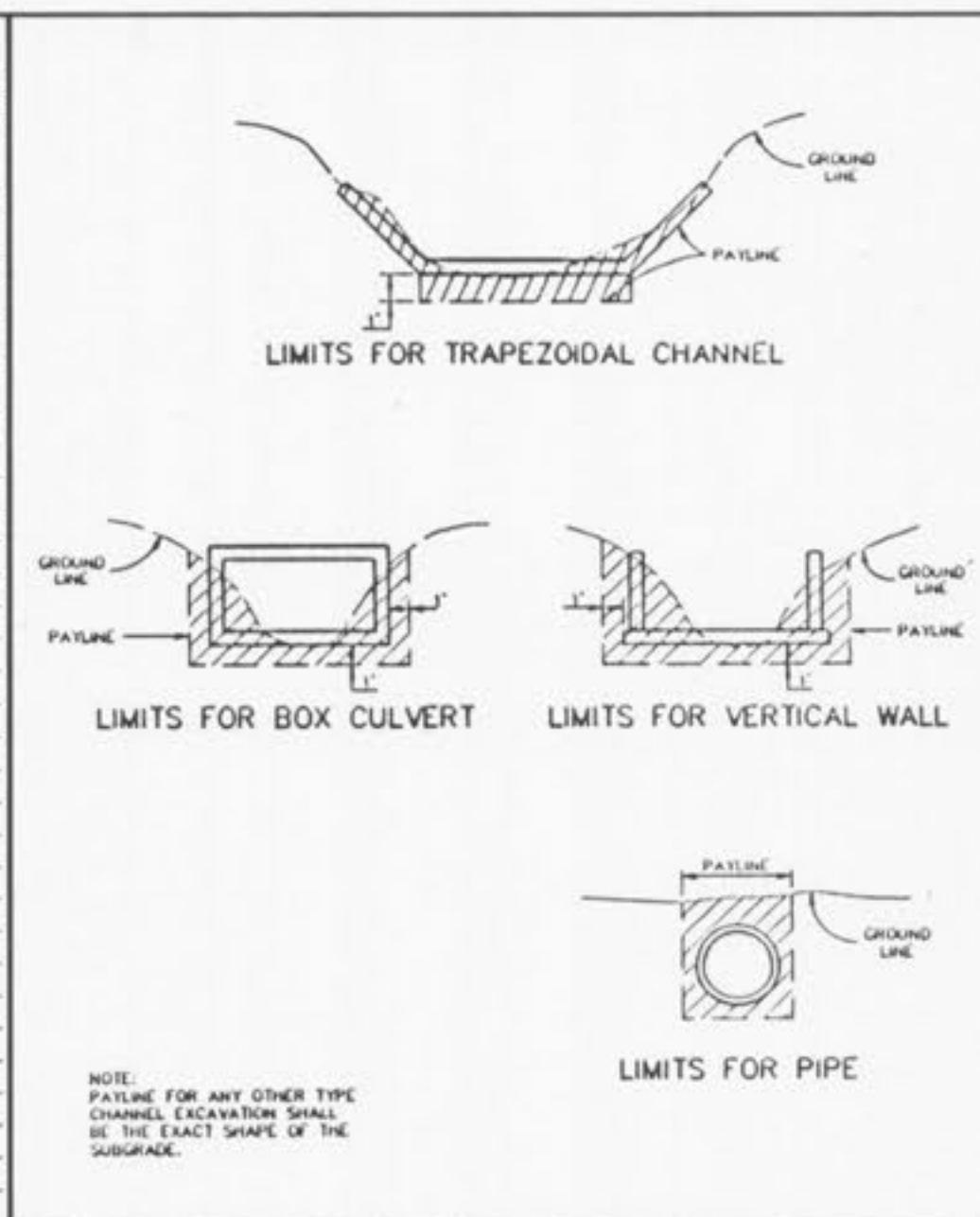

PAYLINE LIMITS FOR EXCAVATION
METROPOLITAN ST. LOUIS SEWER DISTRICT
Standard Details of Sewer Construction
Dr. W.S.H. Ch. J.C.K. 1992 SHEET 2

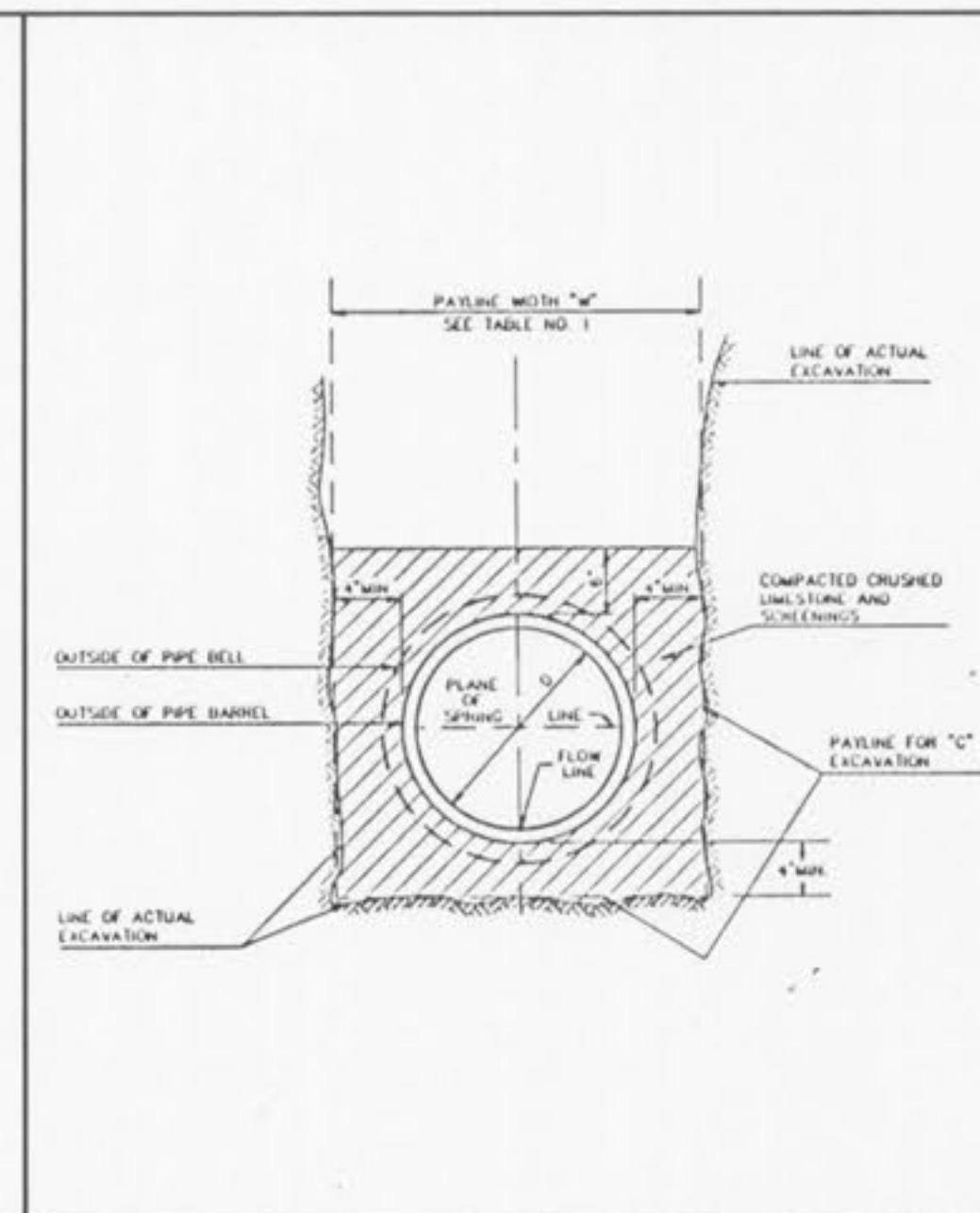

PIPE BEDDING CLASS "C" (MODIFIED FOR REINFORCED CONCRETE PIPE)
METROPOLITAN ST. LOUIS SEWER DISTRICT
Standard Details of Sewer Construction
Dr. W.S.H. Ch. J.C.K. 1992 SHEET 3

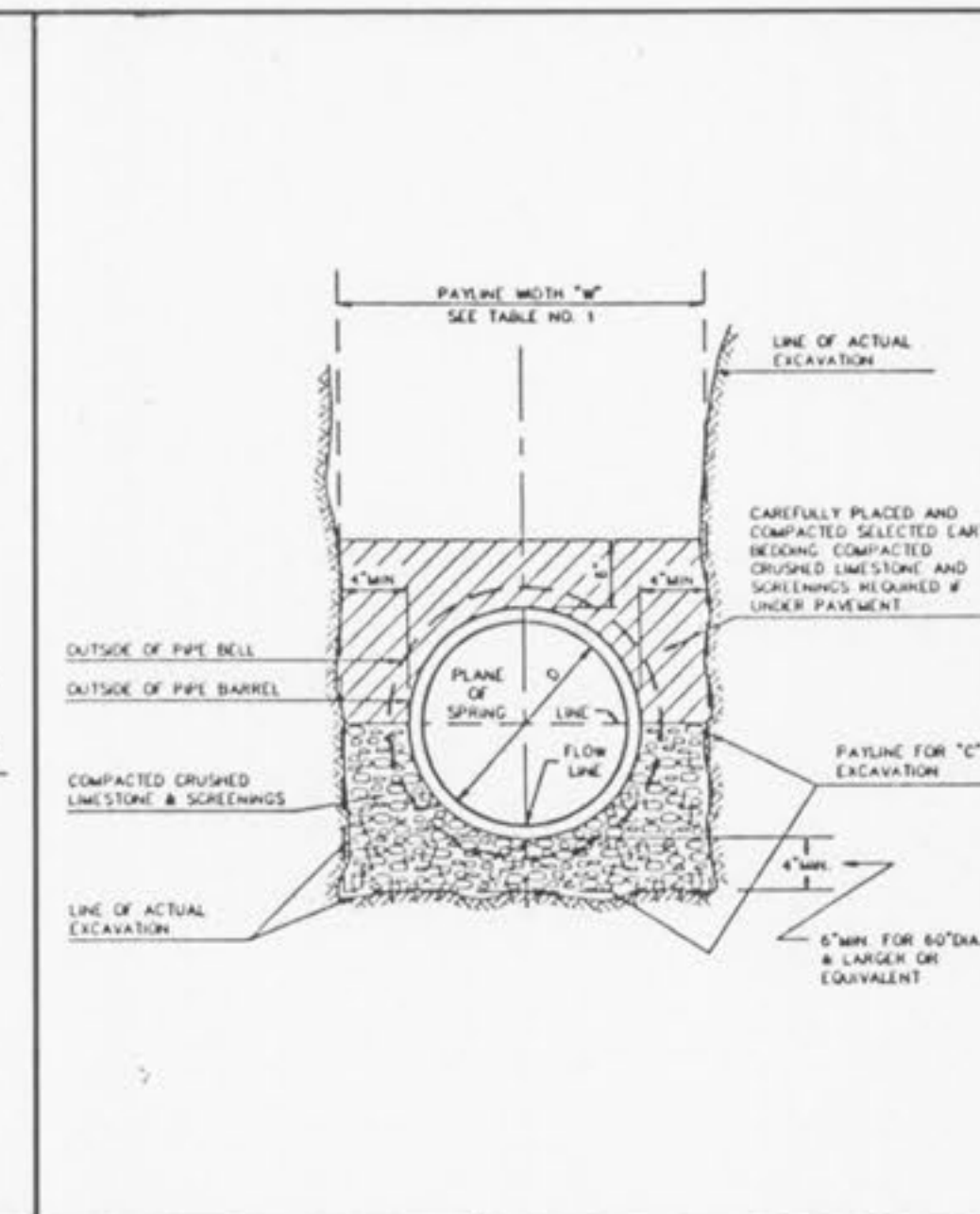

CONCRETE ENCASEMENT
METROPOLITAN ST. LOUIS SEWER DISTRICT
Standard Details of Sewer Construction
Dr. W.S.H. Ch. J.C.K. 1992 SHEET 4

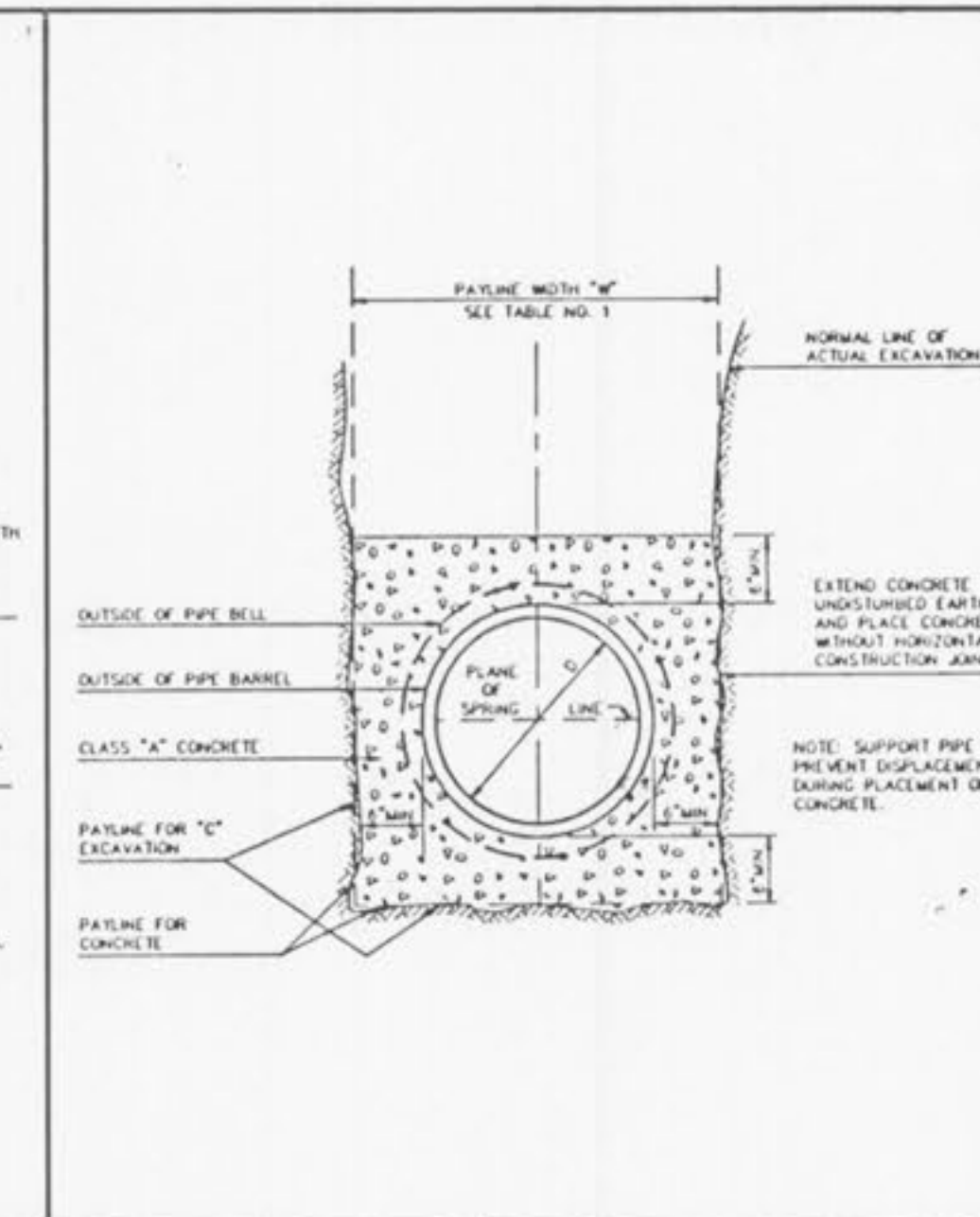

CONCRETE CRADLE
METROPOLITAN ST. LOUIS SEWER DISTRICT
Standard Details of Sewer Construction
Dr. W.S.H. Ch. J.C.K. 1992 SHEET 5

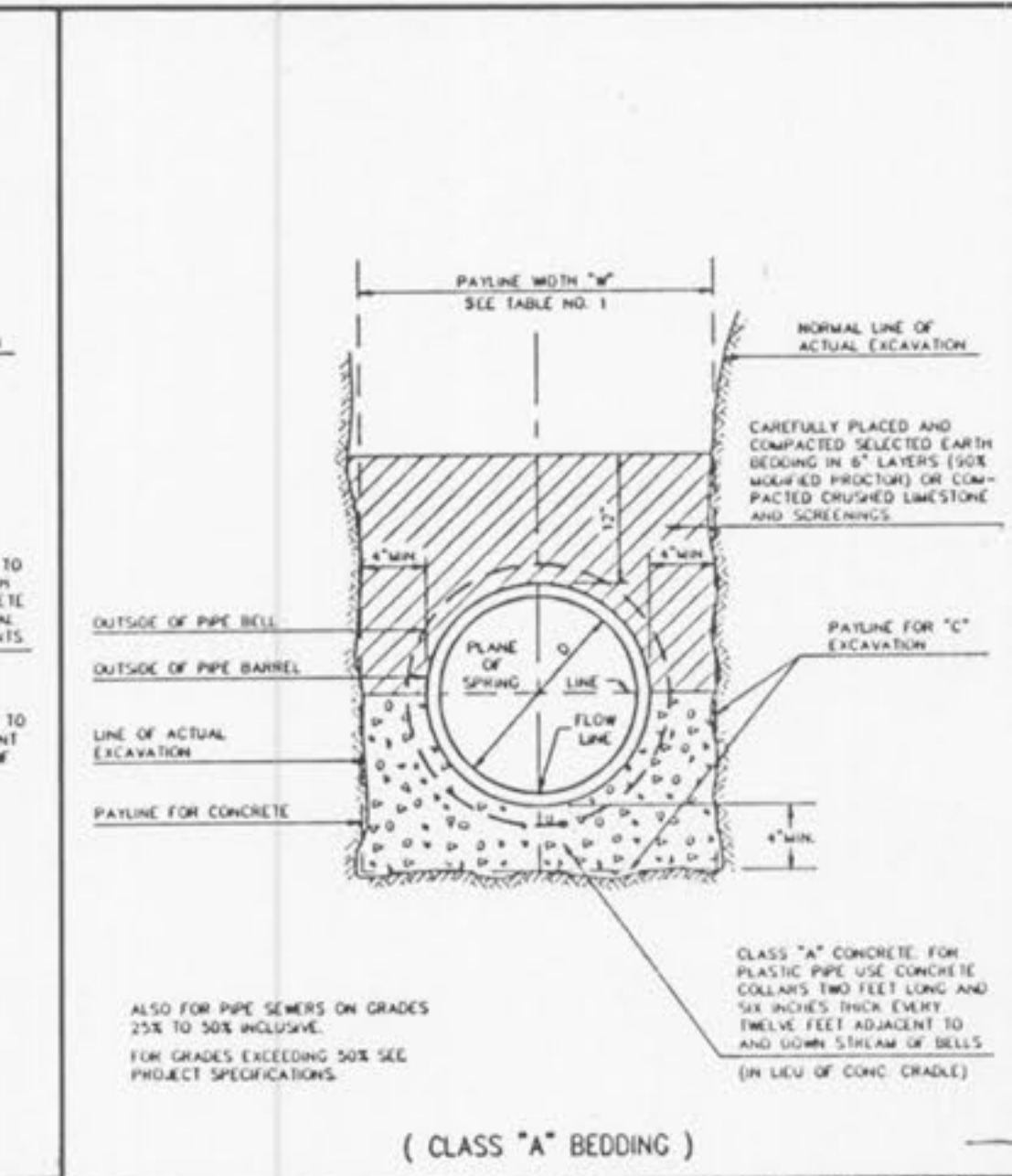

CONCRETE CRADLE
METROPOLITAN ST. LOUIS SEWER DISTRICT
Standard Details of Sewer Construction
Dr. W.S.H. Ch. J.C.K. 1992 SHEET 6

SECTION	TOP TRANSITION	BOTTOM SECTION	DIMENSION
SECTION OF MANHOLE	UPPER	26 1/2" DIA.	
	LOWER	42" DIA.	
SECTION OF MANHOLE	B" THRU 24" DIA. PIPE	42" DIA.	
	27" THRU 36" DIA. PIPE	42" SQUARE	

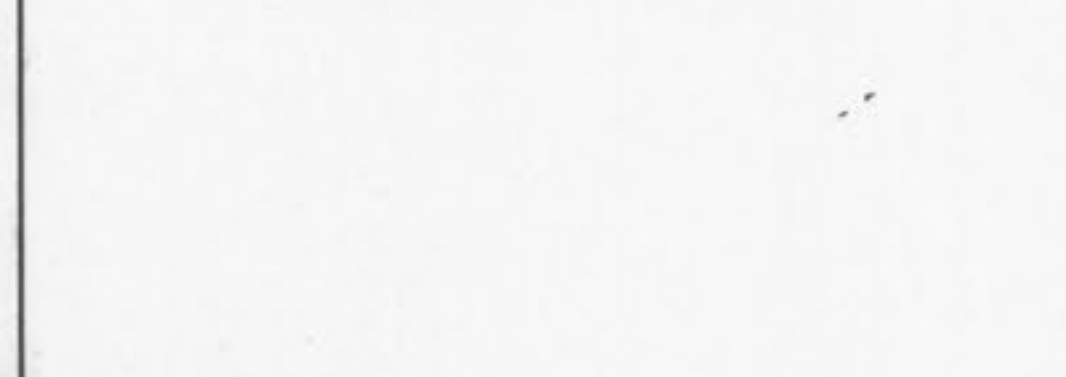
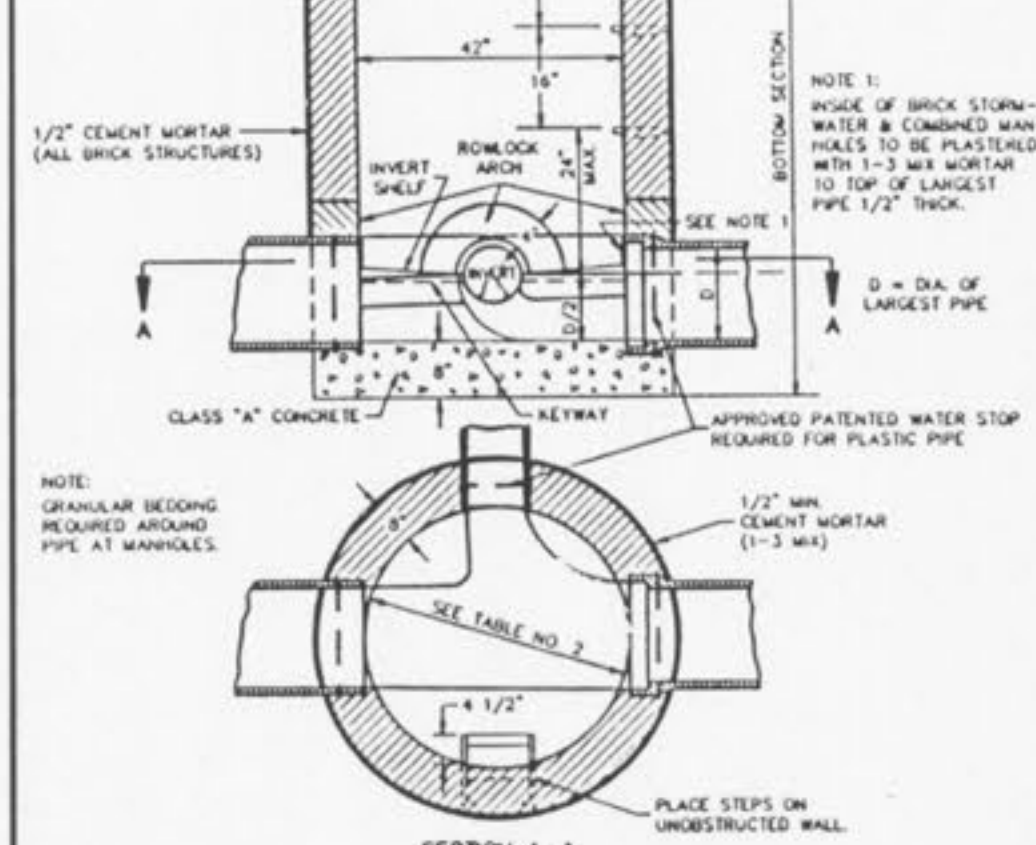
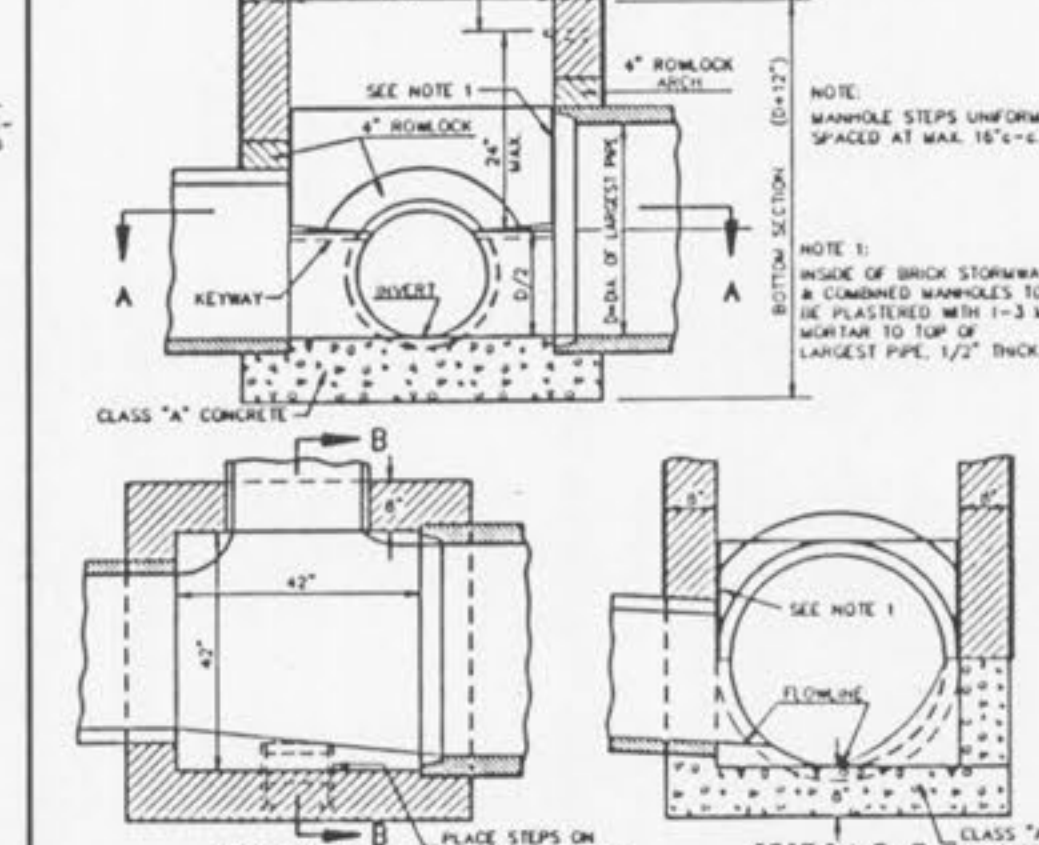

TABLE NO. 2
STANDARD MANHOLE DIMENSIONS
METROPOLITAN ST. LOUIS SEWER DISTRICT
Standard Details of Sewer Construction
Dr. R.C.W. Ch. J.C.K. 1992 SHEET 7



LINE MANHOLE
METROPOLITAN ST. LOUIS SEWER DISTRICT
Standard Details of Sewer Construction
Dr. W.S.H. Ch. J.C.K. 1992 SHEET 8



TYPICAL LINE MANHOLE ON PIPE SEWER 27" THRU 36" IN DIAMETER
METROPOLITAN ST. LOUIS SEWER DISTRICT
Standard Details of Sewer Construction
Dr. W.S.H. Ch. J.C.K. 1992 SHEET 9

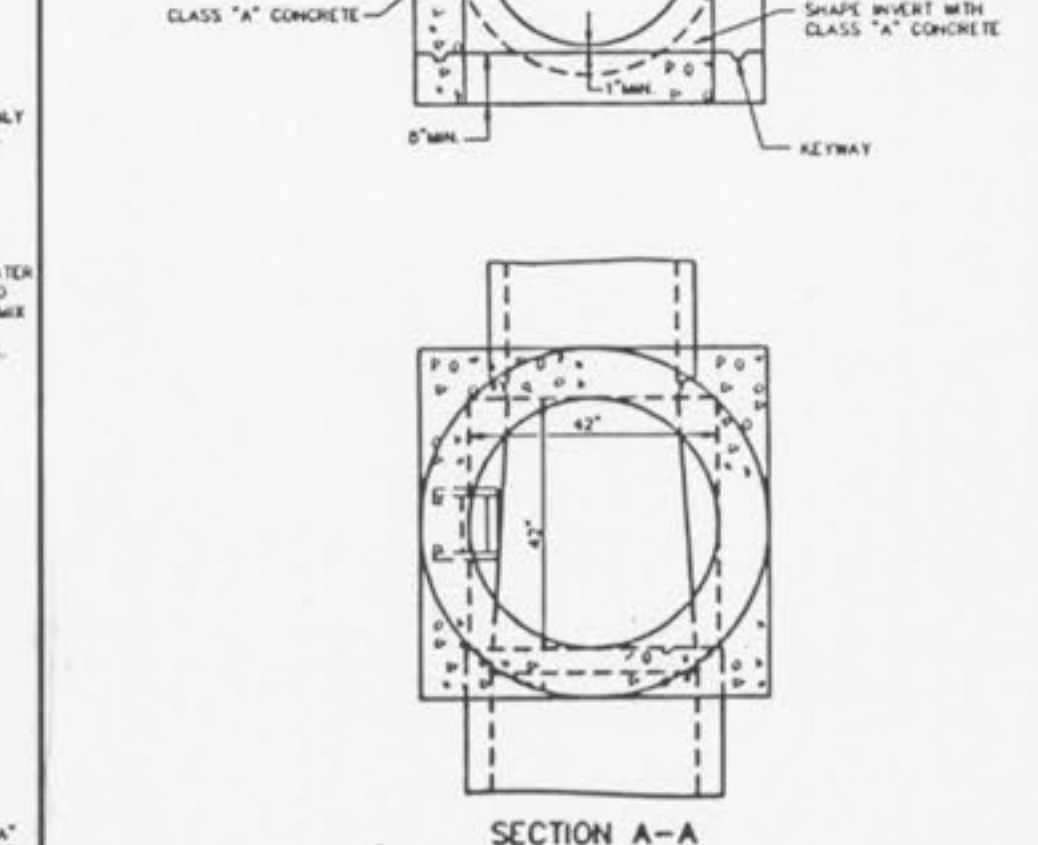

MANHOLE ON PIPE SEWER 27" THRU 36" (ALTERNATE)
METROPOLITAN ST. LOUIS SEWER DISTRICT
Standard Details of Sewer Construction
Dr. D.A.B. Ch. J.C.K. 1992 SHEET 10

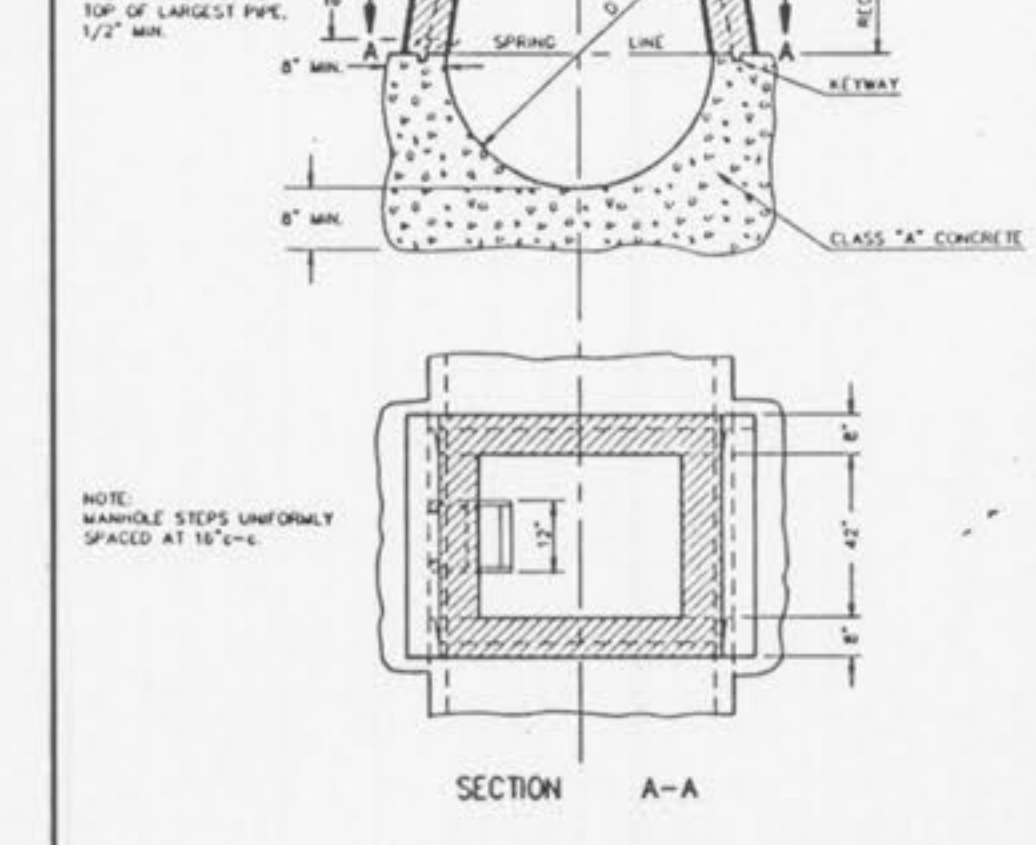

MANHOLE ON CONCRETE PIPE SEWERS 39" THRU 54" DIAMETER
METROPOLITAN ST. LOUIS SEWER DISTRICT
Standard Details of Sewer Construction
Dr. W.S.H. Ch. J.C.K. 1992 SHEET 11

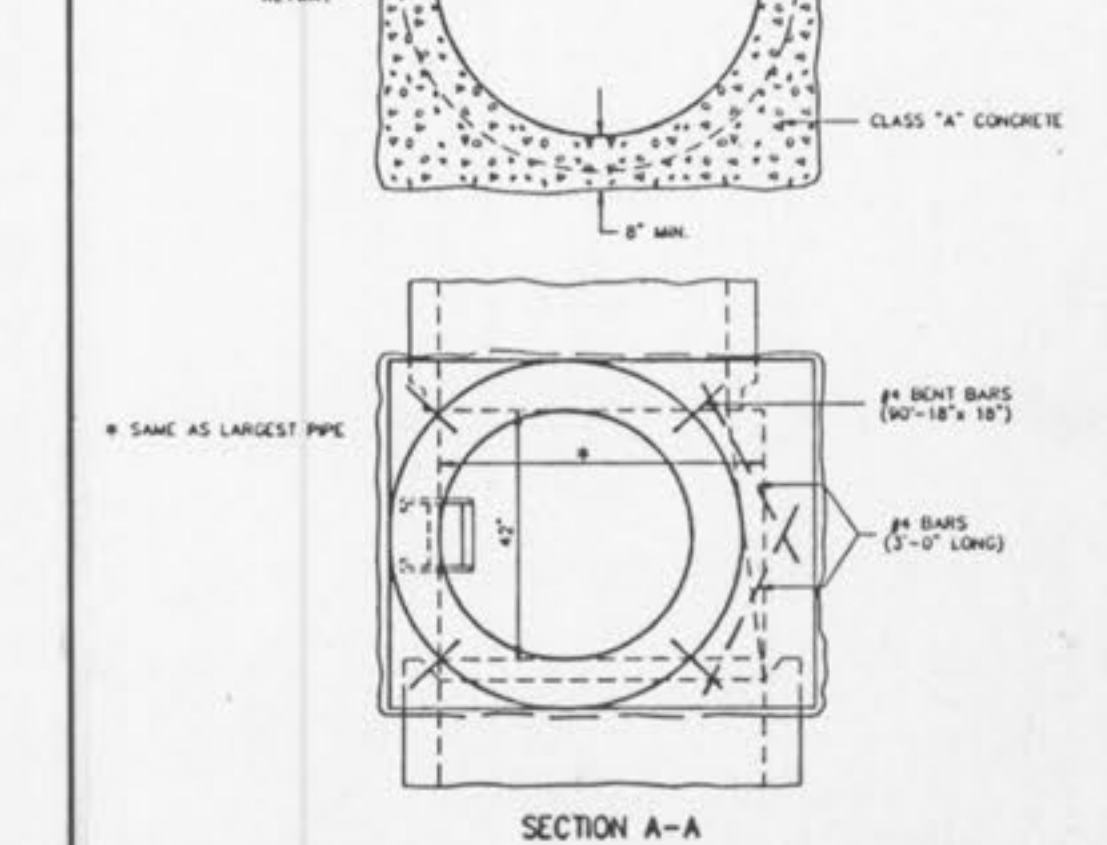

MANHOLE ON CONC. PIPE 39" THRU 54" (ALTERNATE)
METROPOLITAN ST. LOUIS SEWER DISTRICT
Standard Details of Sewer Construction
Dr. W.S.H. Ch. J.C.K. 1992 SHEET 12

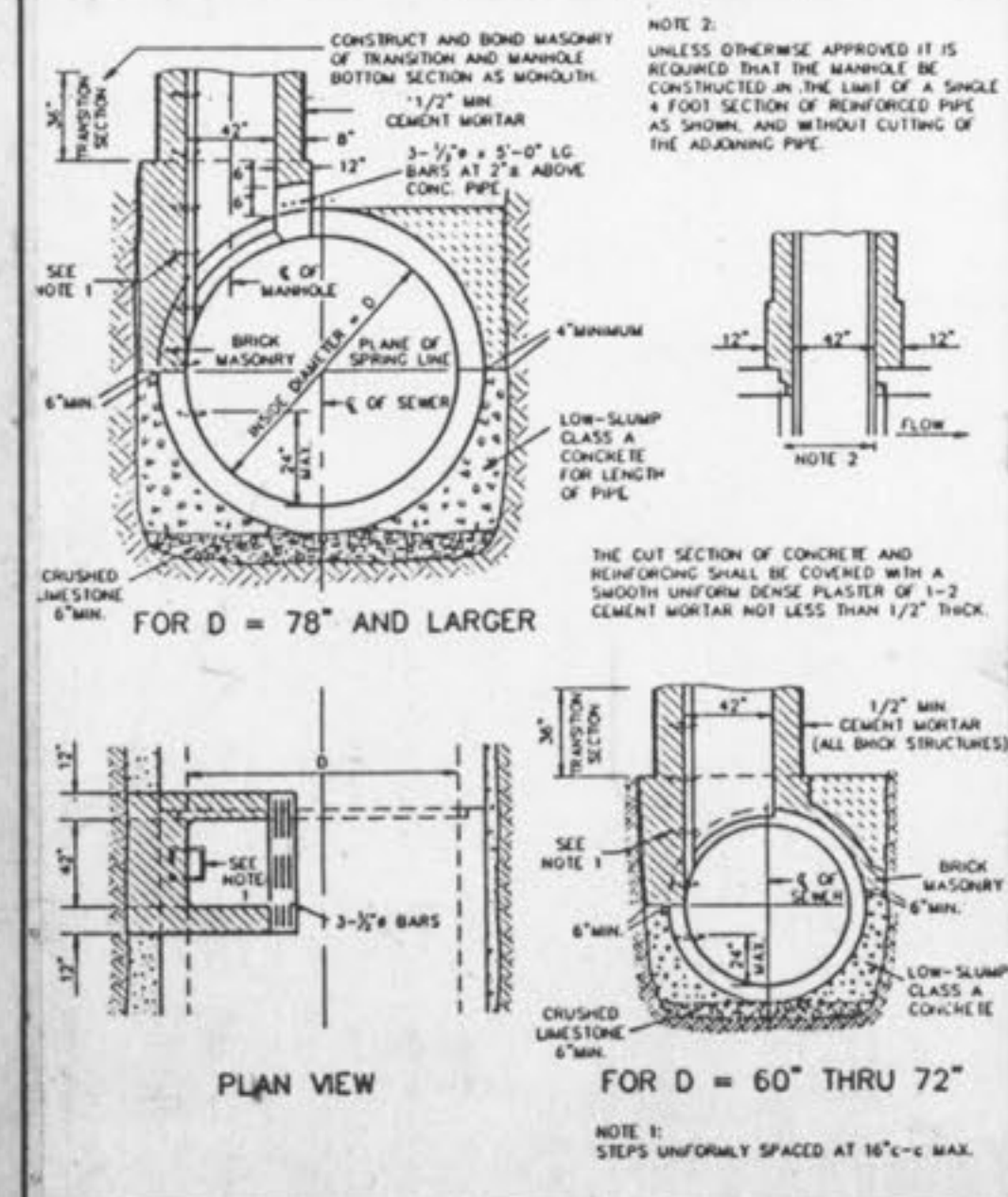

TYPICAL MANHOLE BASE REINFORCED CONCRETE PIPE SEWERS 60" AND LARGER IN DIAMETER
METROPOLITAN ST. LOUIS SEWER DISTRICT
Standard Details of Sewer Construction
Dr. W.S.H. Ch. J.C.K. 1992 SHEET 13

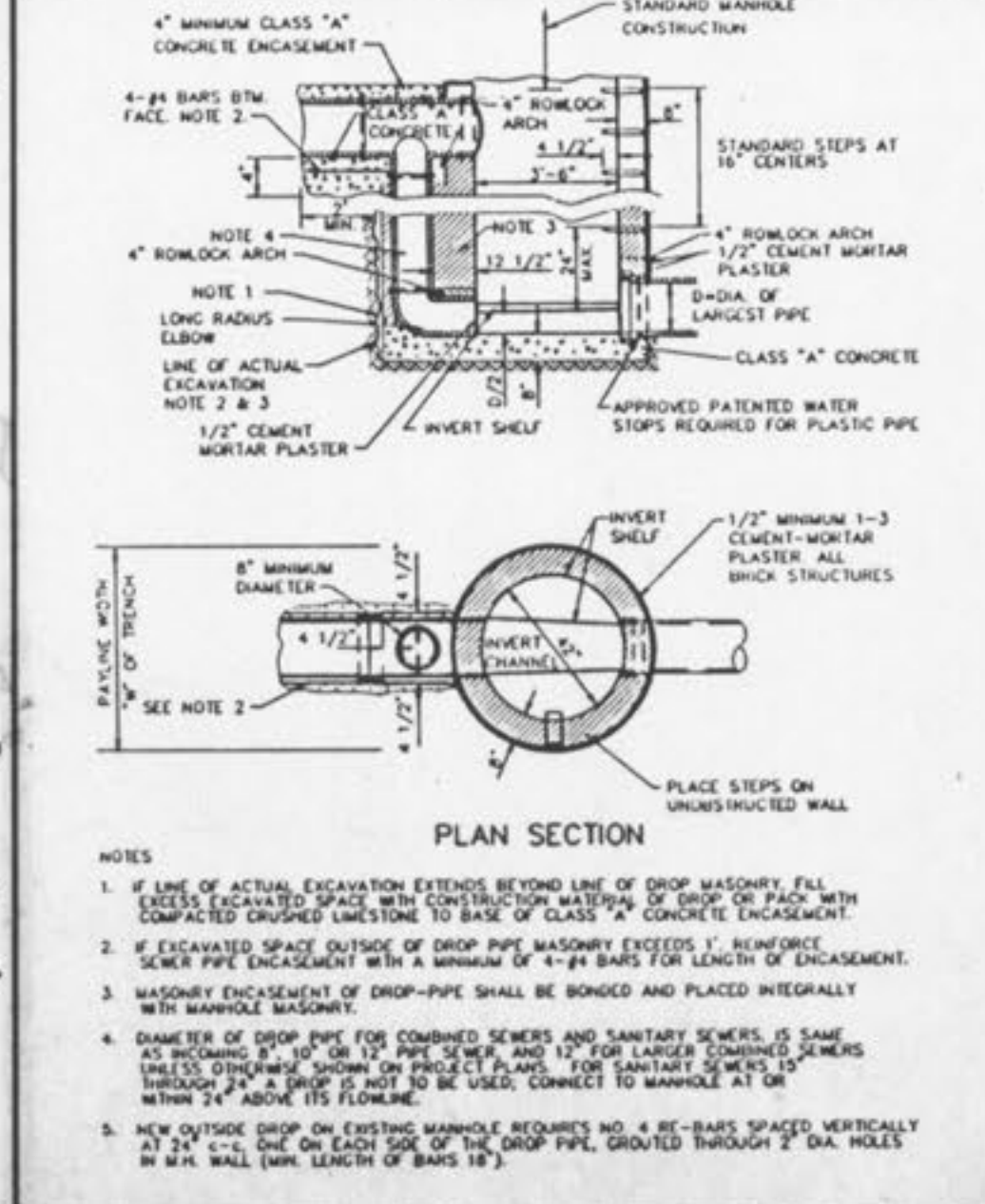

OUTSIDE FOULWATER DROP MANHOLE
METROPOLITAN ST. LOUIS SEWER DISTRICT
Standard Details of Sewer Construction
Dr. W.S.H. Ch. J.C.K. 1992 SHEET 14

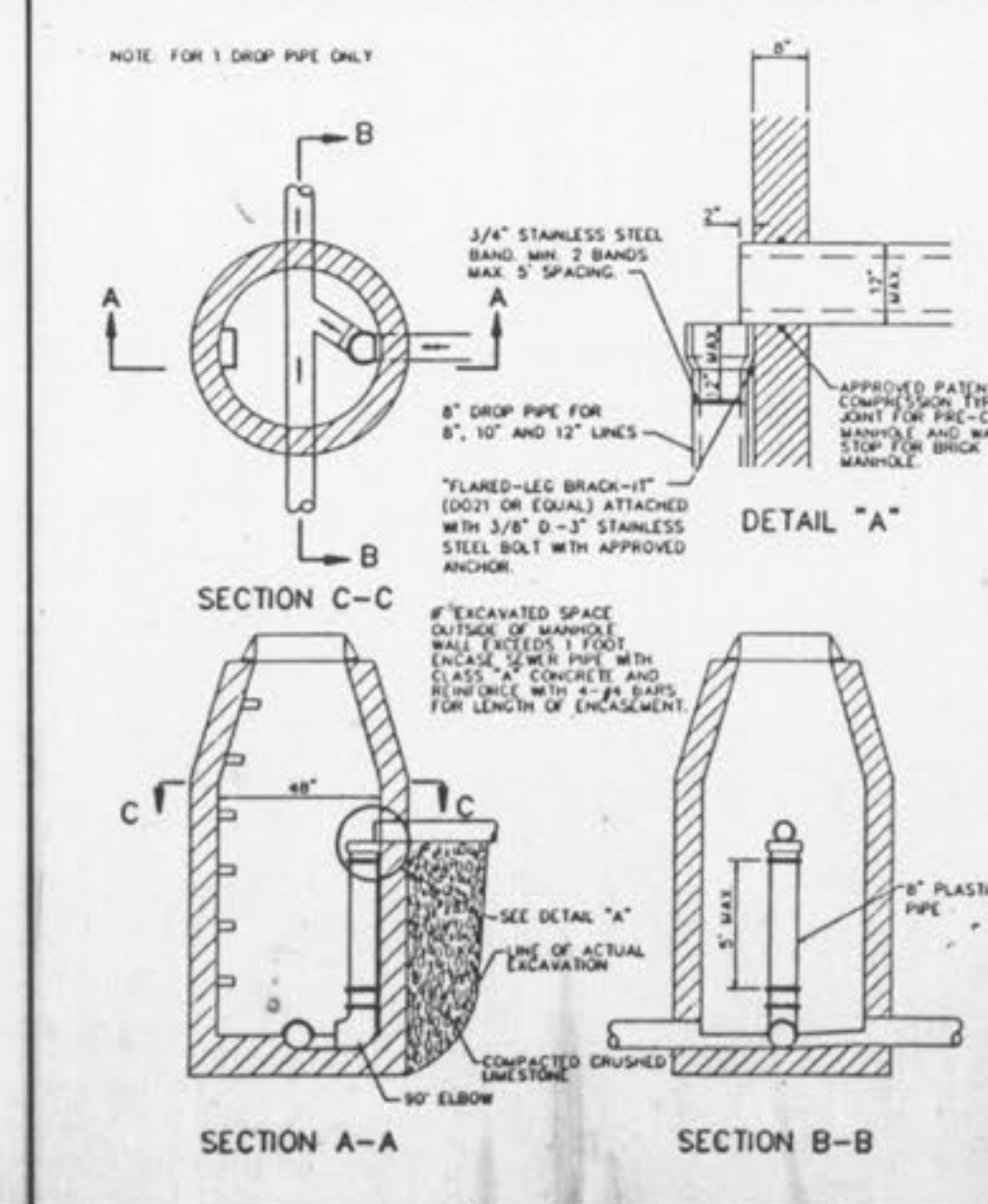

INSIDE FOULWATER DROP MANHOLE
METROPOLITAN ST. LOUIS SEWER DISTRICT
Standard Details of Sewer Construction
Dr. W.S.H. Ch. J.C.K. 1992 SHEET 15

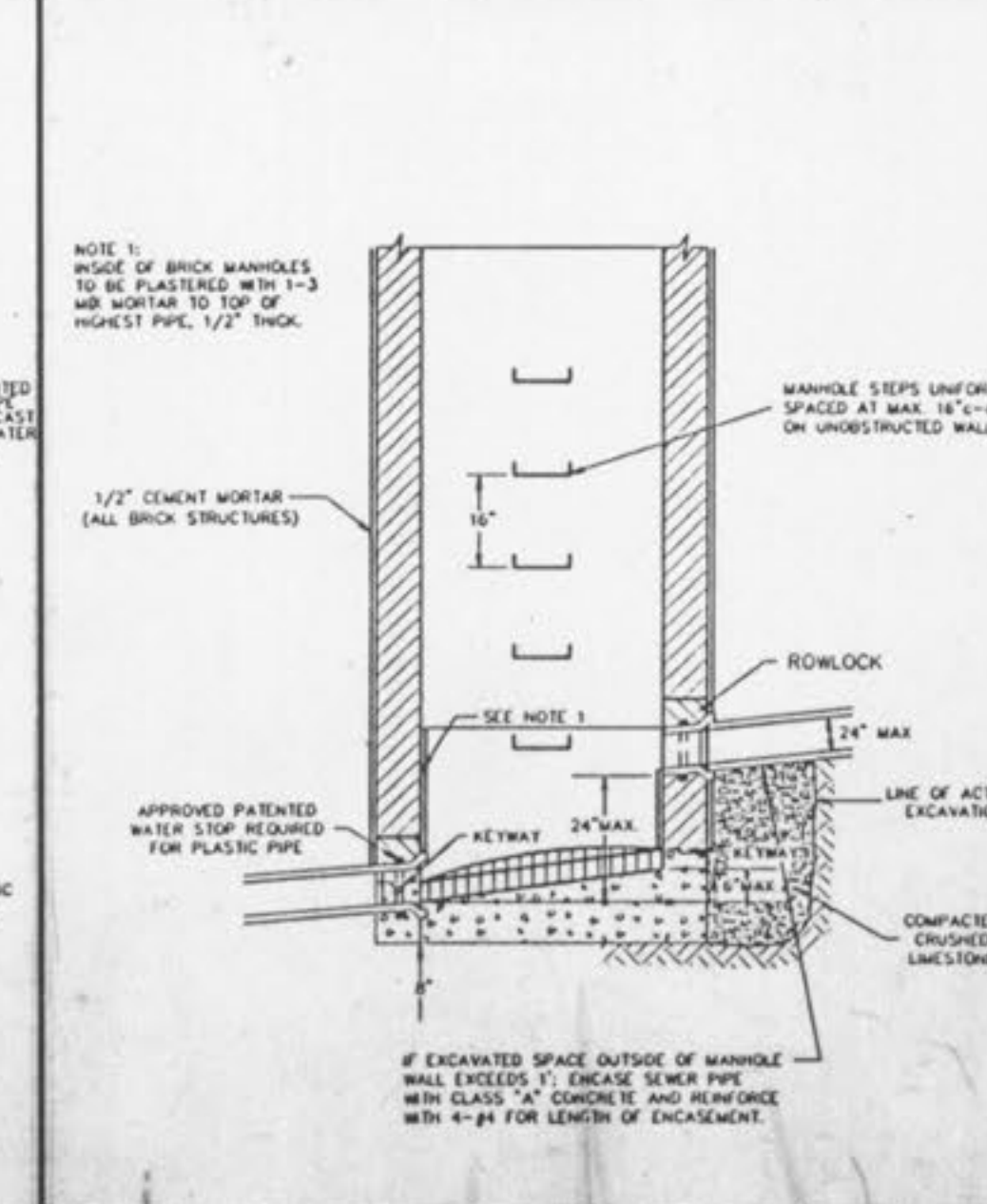

INSIDE FOULWATER DROP MANHOLE (FOR FREE-FALL)
METROPOLITAN ST. LOUIS SEWER DISTRICT
Standard Details of Sewer Construction
Dr. R.C.W. Ch. J.C.K. 1992 SHEET 16

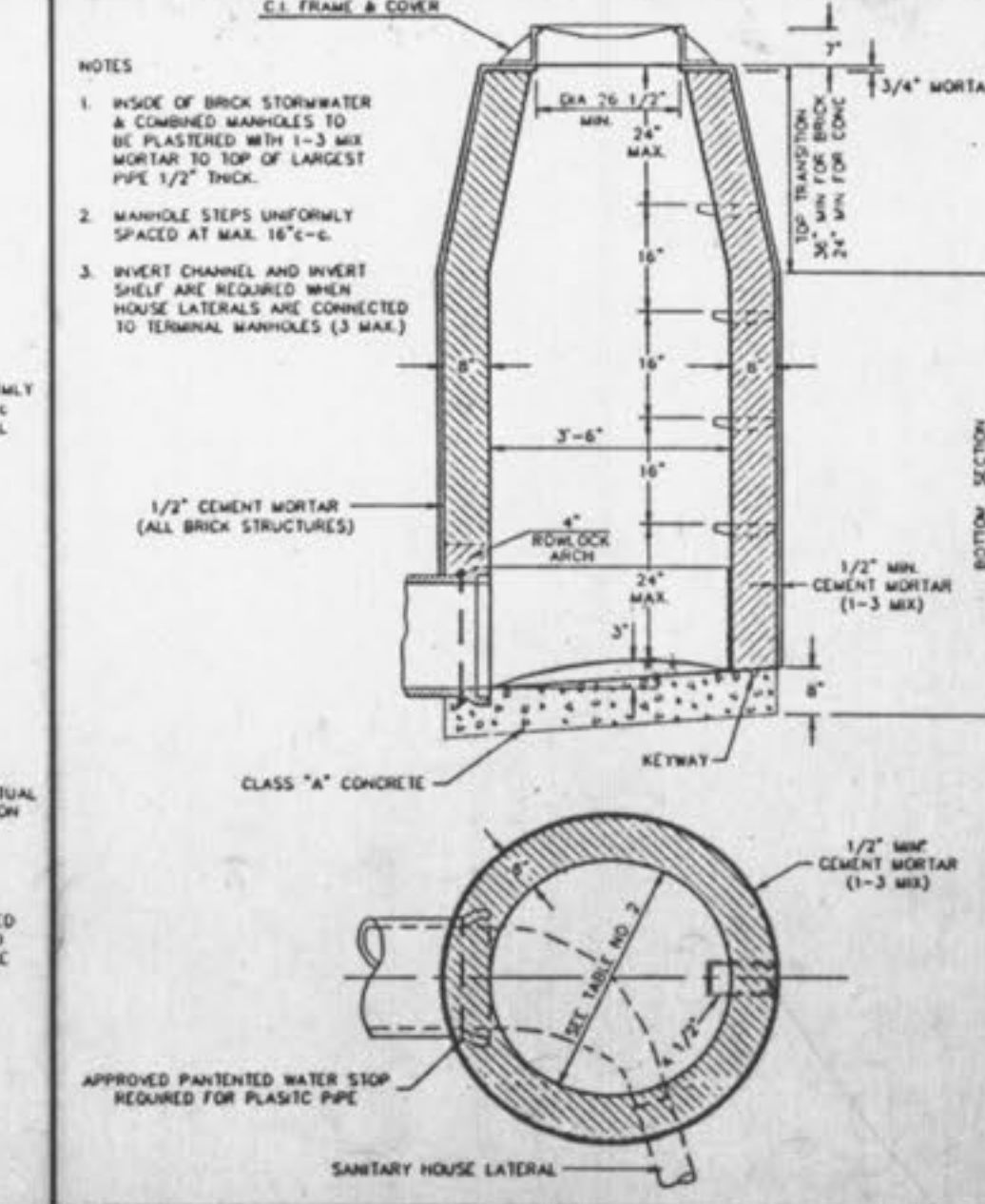

TERMINAL MANHOLE
METROPOLITAN ST. LOUIS SEWER DISTRICT
Standard Details of Sewer Construction
Dr. W.S.H. Ch. J.C.K. 1992 SHEET 17

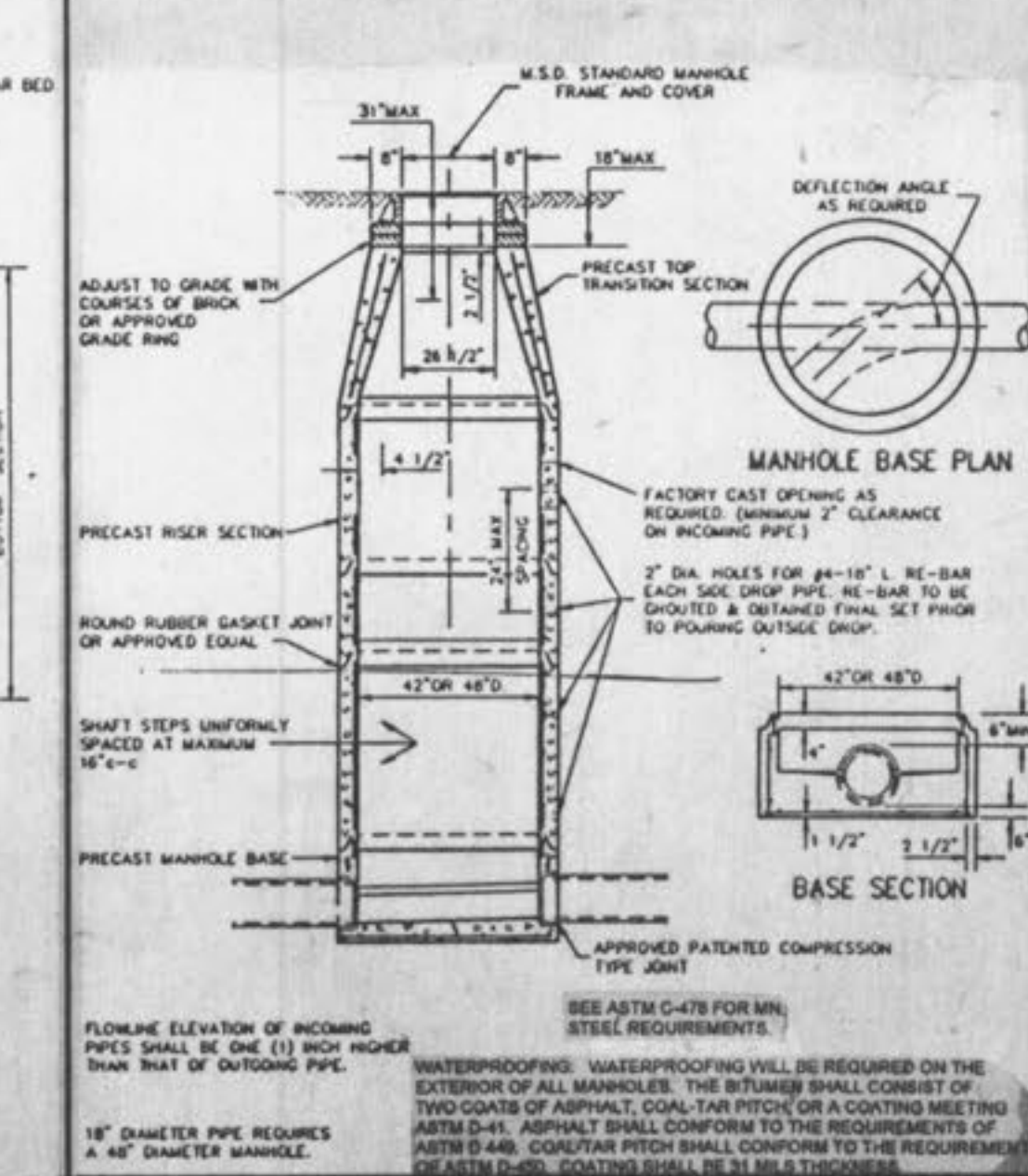

PRE-CAST CONCRETE MANHOLE FOR SEWERS 8" THROUGH 18"
METROPOLITAN ST. LOUIS SEWER DISTRICT
Standard Details of Sewer Construction
Dr. W.S.H. Ch. J.C.K. 1992 SHEET 18