

PRE-CAST CONCRETE UNIT FOR SINGLE STREET INLET  
 METROPOLITAN ST. LOUIS SEWER DISTRICT Standard Details of Sewer Construction  
 Dr. W.S.H. Ch. J.C.K. 1992 SHEET 37

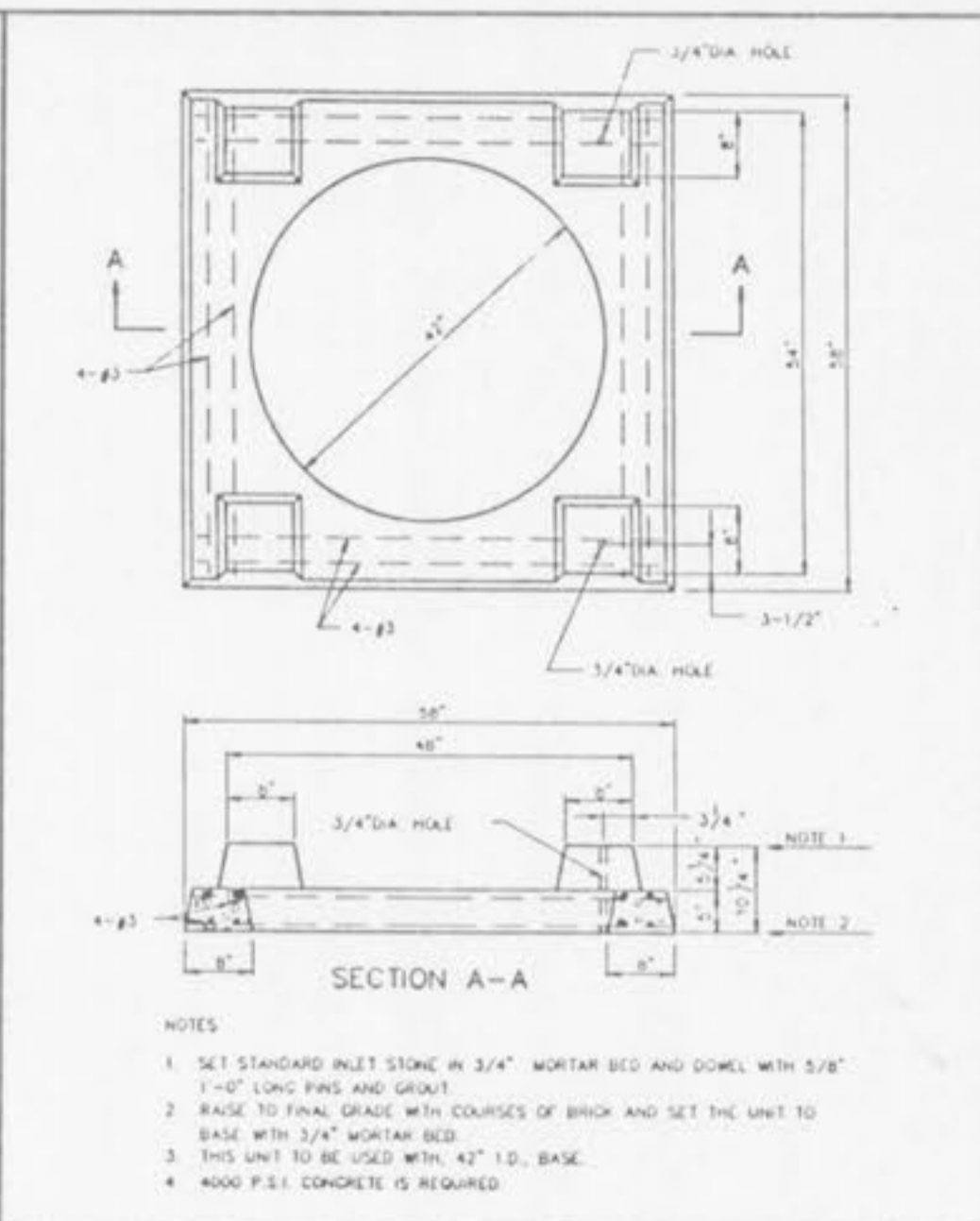

PRE-CAST CONCRETE UNIT FOR 4 WAY AREA INLET  
 METROPOLITAN ST. LOUIS SEWER DISTRICT Standard Details of Sewer Construction  
 Dr. D.A.B. Ch. J.C.K. 1992 SHEET 38

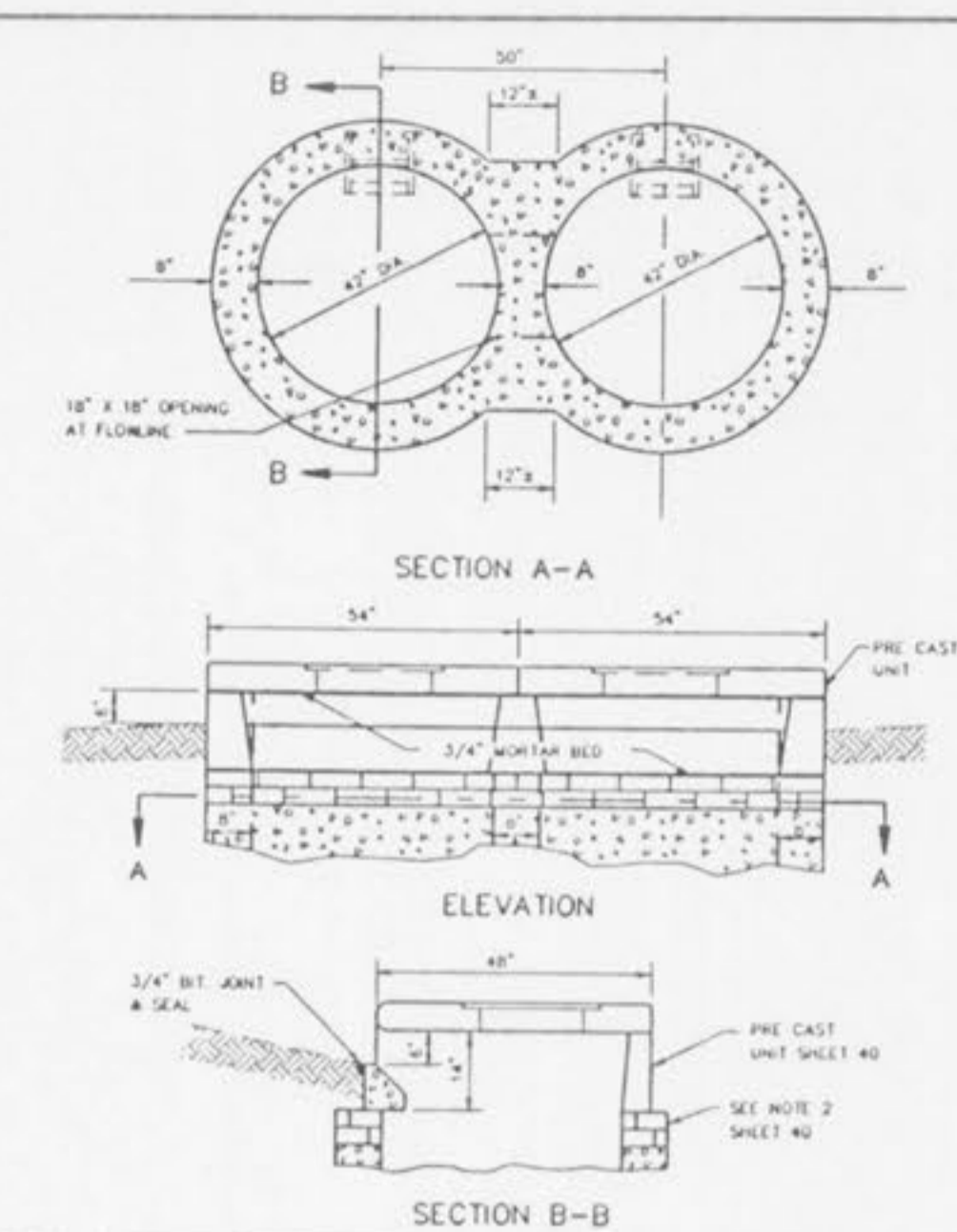

CONCRETE DOUBLE STREET INLET W/PRE CAST CONCRETE UNIT A  
 METROPOLITAN ST. LOUIS SEWER DISTRICT Standard Details of Sewer Construction  
 Dr. R.C.W. Ch. J.C.K. 1992 SHEET 39

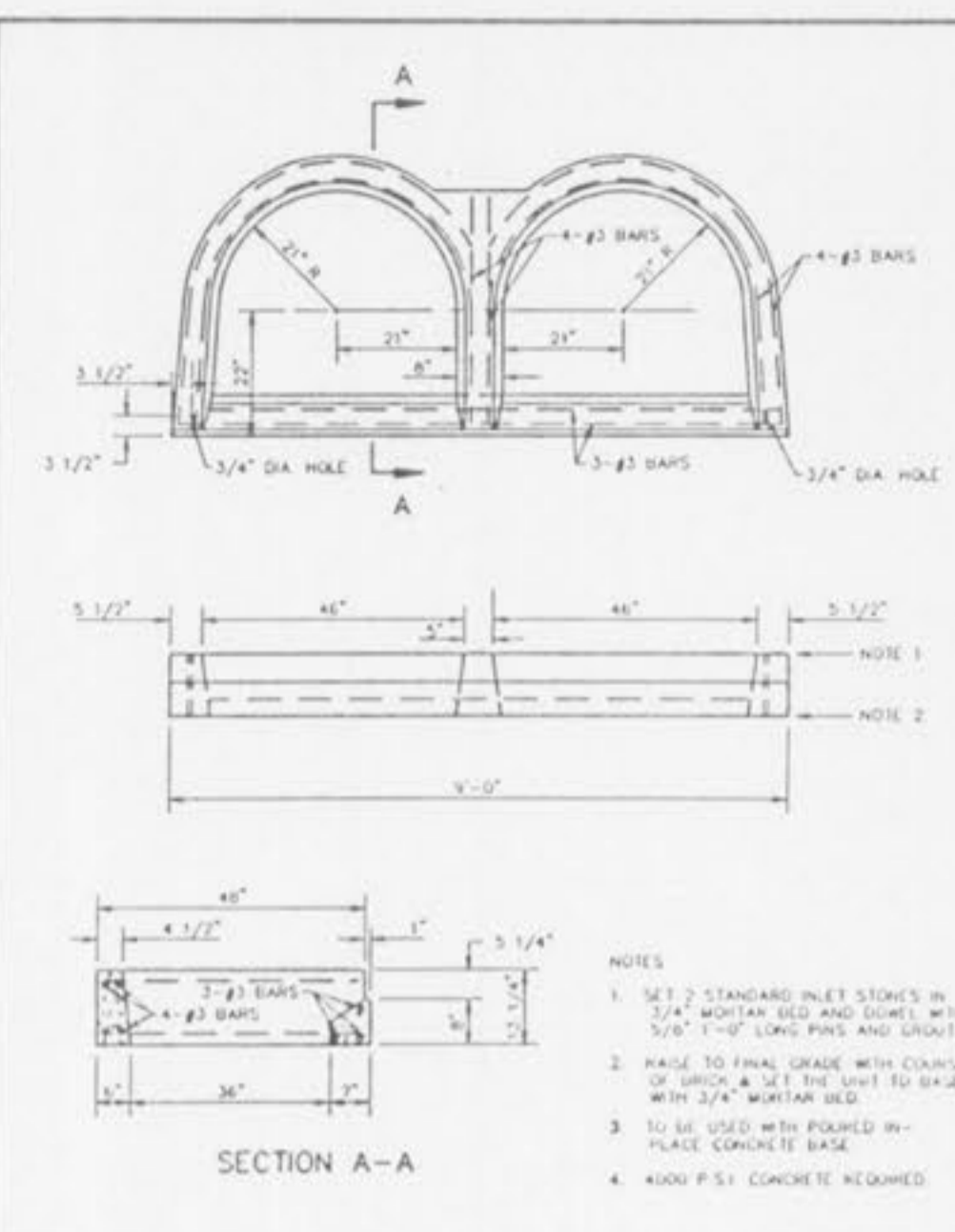

PRE-CAST CONCRETE UNIT A FOR STREET DOUBLE INLET  
 METROPOLITAN ST. LOUIS SEWER DISTRICT Standard Details of Sewer Construction  
 Dr. R.C.W. Ch. J.C.K. 1992 SHEET 40

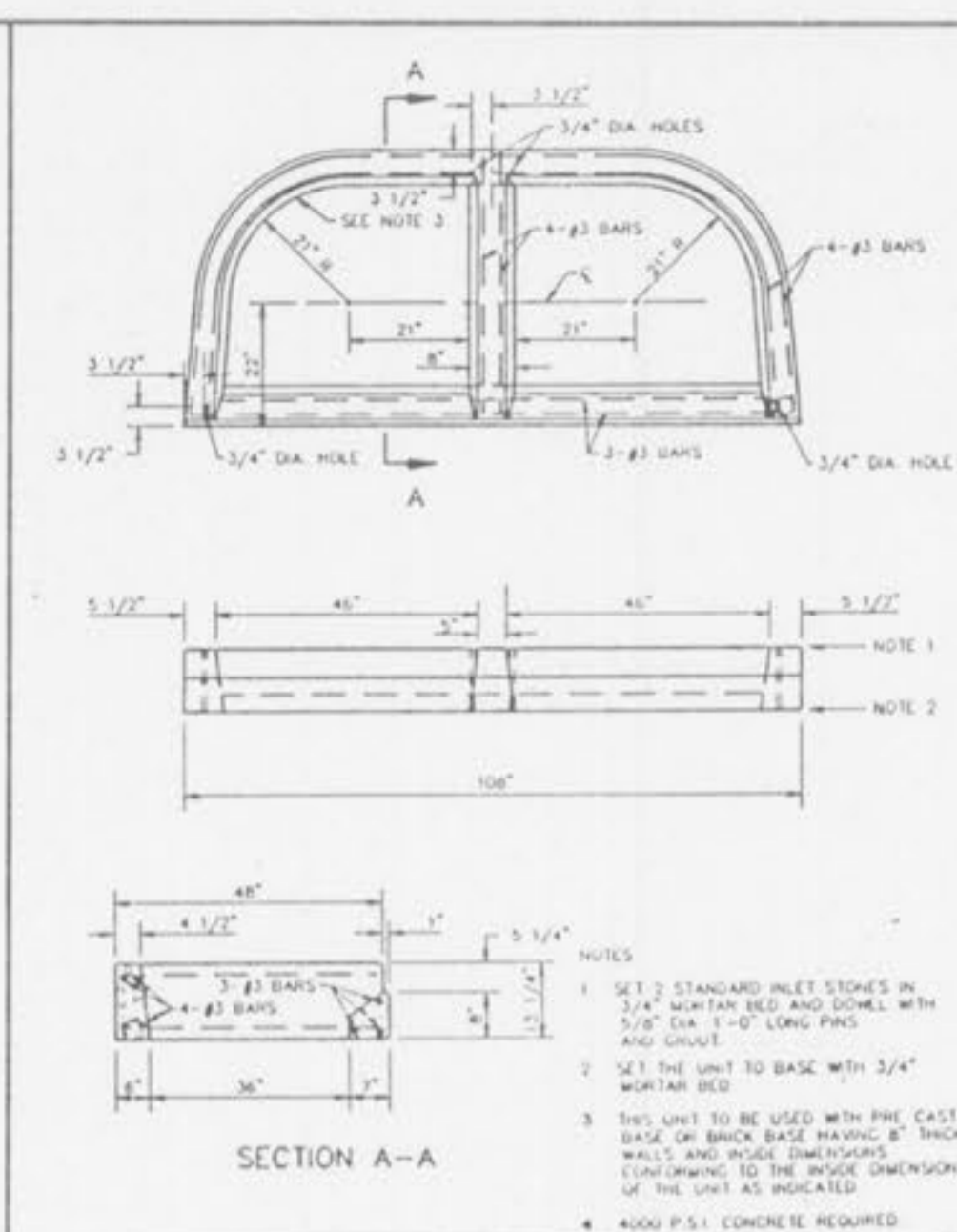

PRE-CAST CONCRETE UNIT B FOR STREET DOUBLE INLET  
 METROPOLITAN ST. LOUIS SEWER DISTRICT Standard Details of Sewer Construction  
 Dr. R.C.W. Ch. J.C.K. 1992 SHEET 41

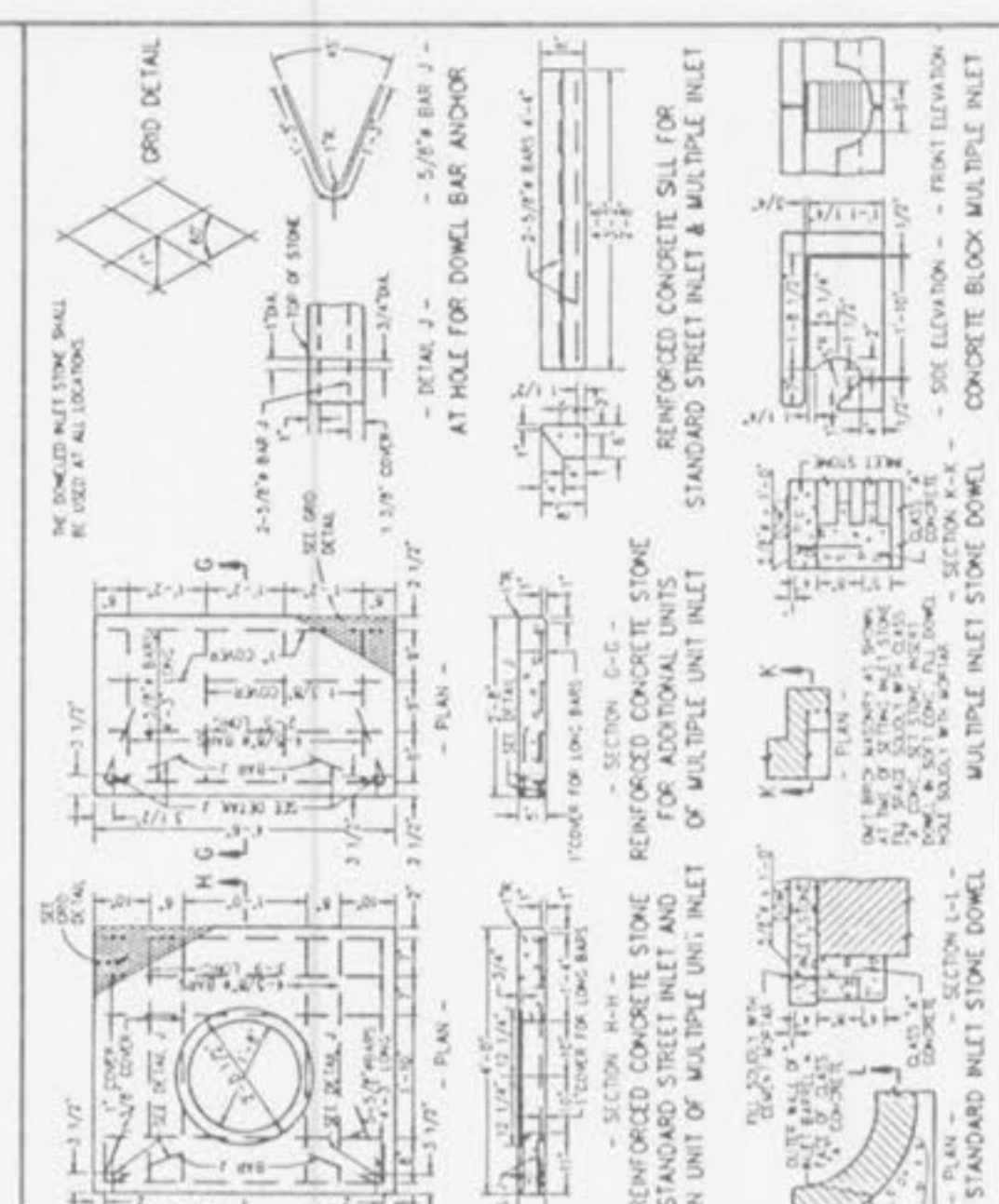

STANDARD - INLET STONES, BLOCKS & DESIGN DETAILS  
 METROPOLITAN ST. LOUIS SEWER DISTRICT Standard Details of Sewer Construction  
 Dr. W.S.H. Ch. J.C.K. 1992 SHEET 42

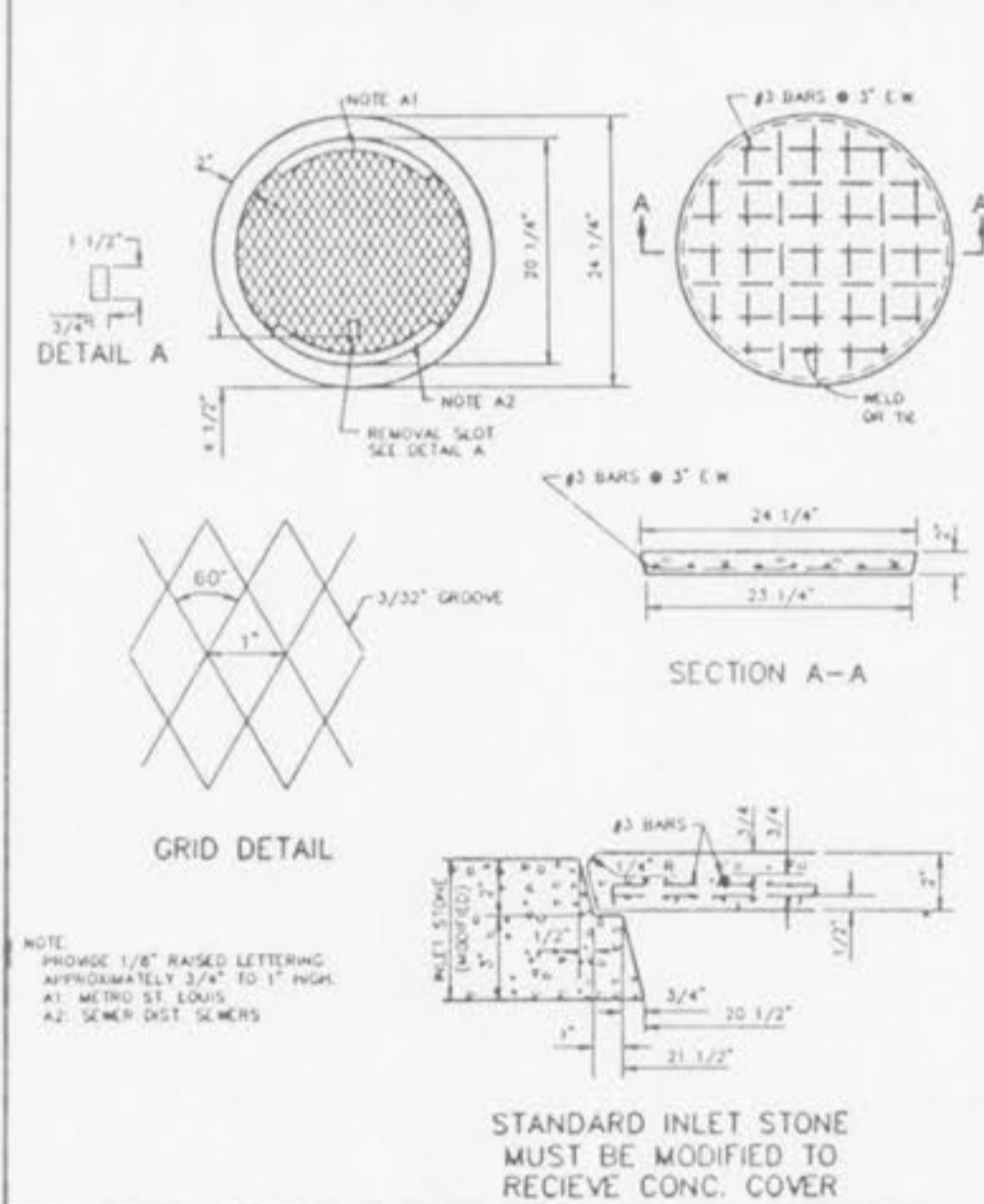

PRE-CAST CONCRETE INLET COVER  
 METROPOLITAN ST. LOUIS SEWER DISTRICT Standard Details of Sewer Construction  
 Dr. R.C.W. Ch. J.C.K. 1992 SHEET 43

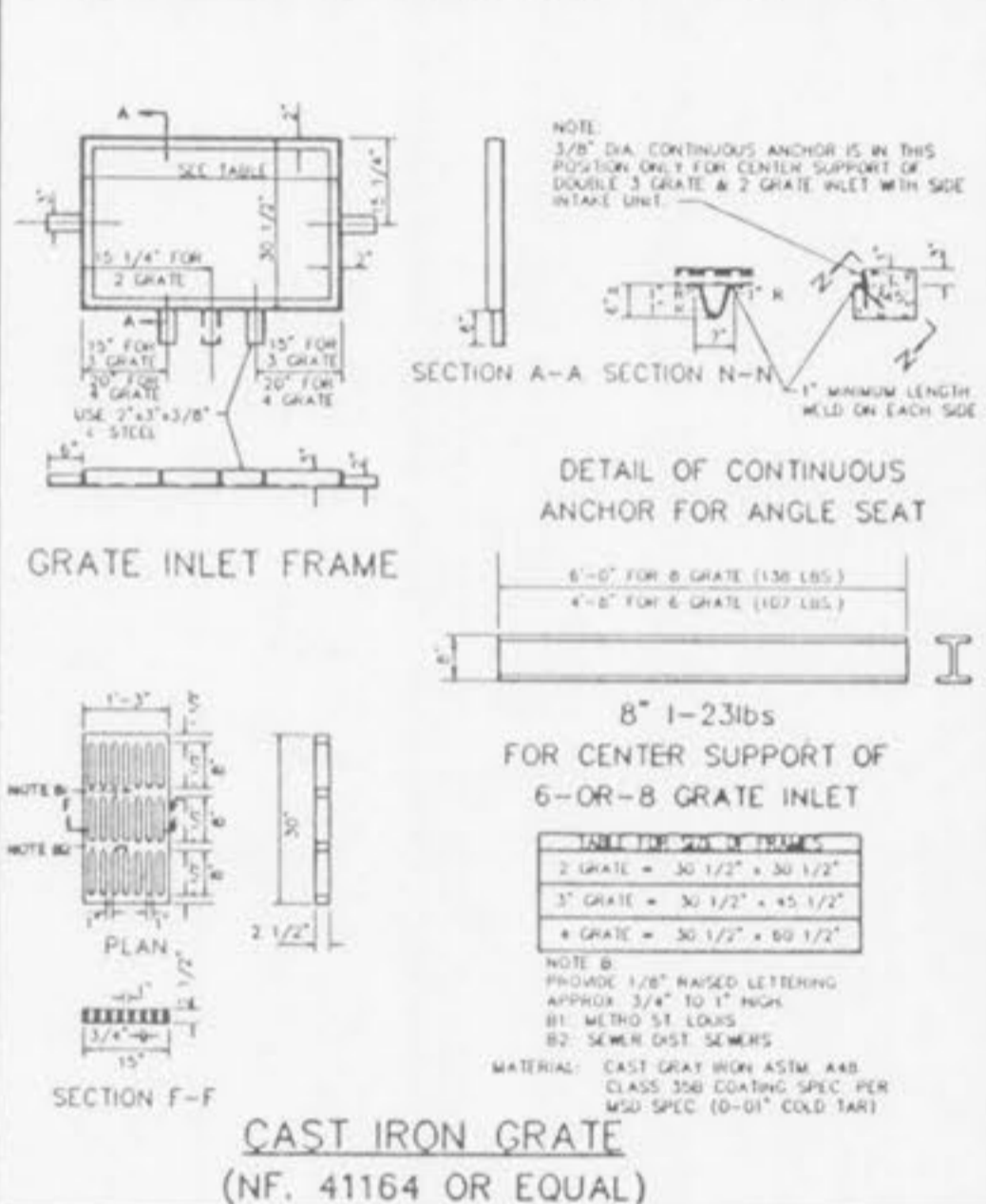

DETAILS OF INLET FRAME AND GRATES  
 METROPOLITAN ST. LOUIS SEWER DISTRICT Standard Details of Sewer Construction  
 Dr. R.C.W. Ch. J.C.K. 1992 SHEET 44

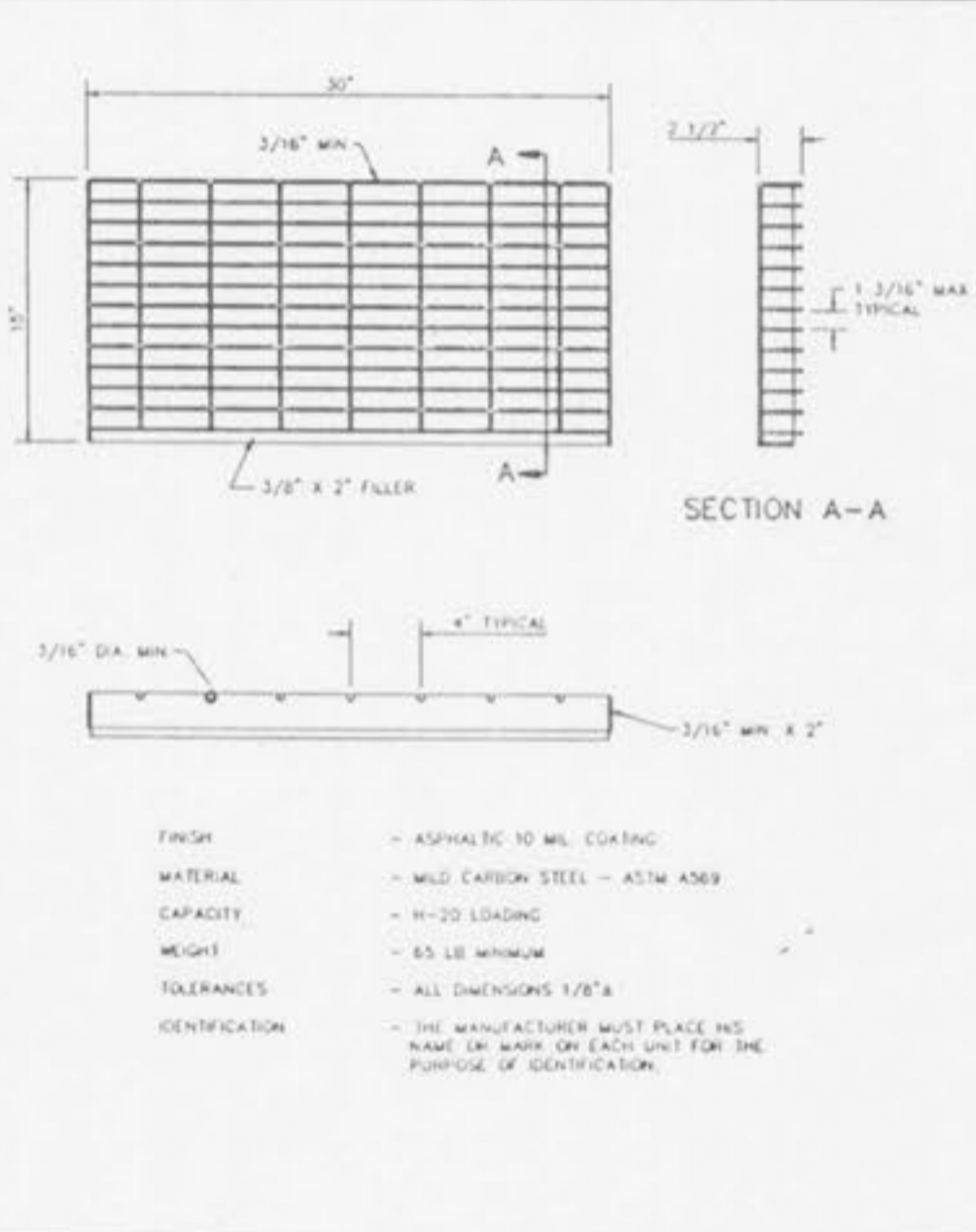

DETAIL OF STEEL GRATE  
 METROPOLITAN ST. LOUIS SEWER DISTRICT Standard Details of Sewer Construction  
 Dr. R.C.W. Ch. J.C.K. 1992 SHEET 45

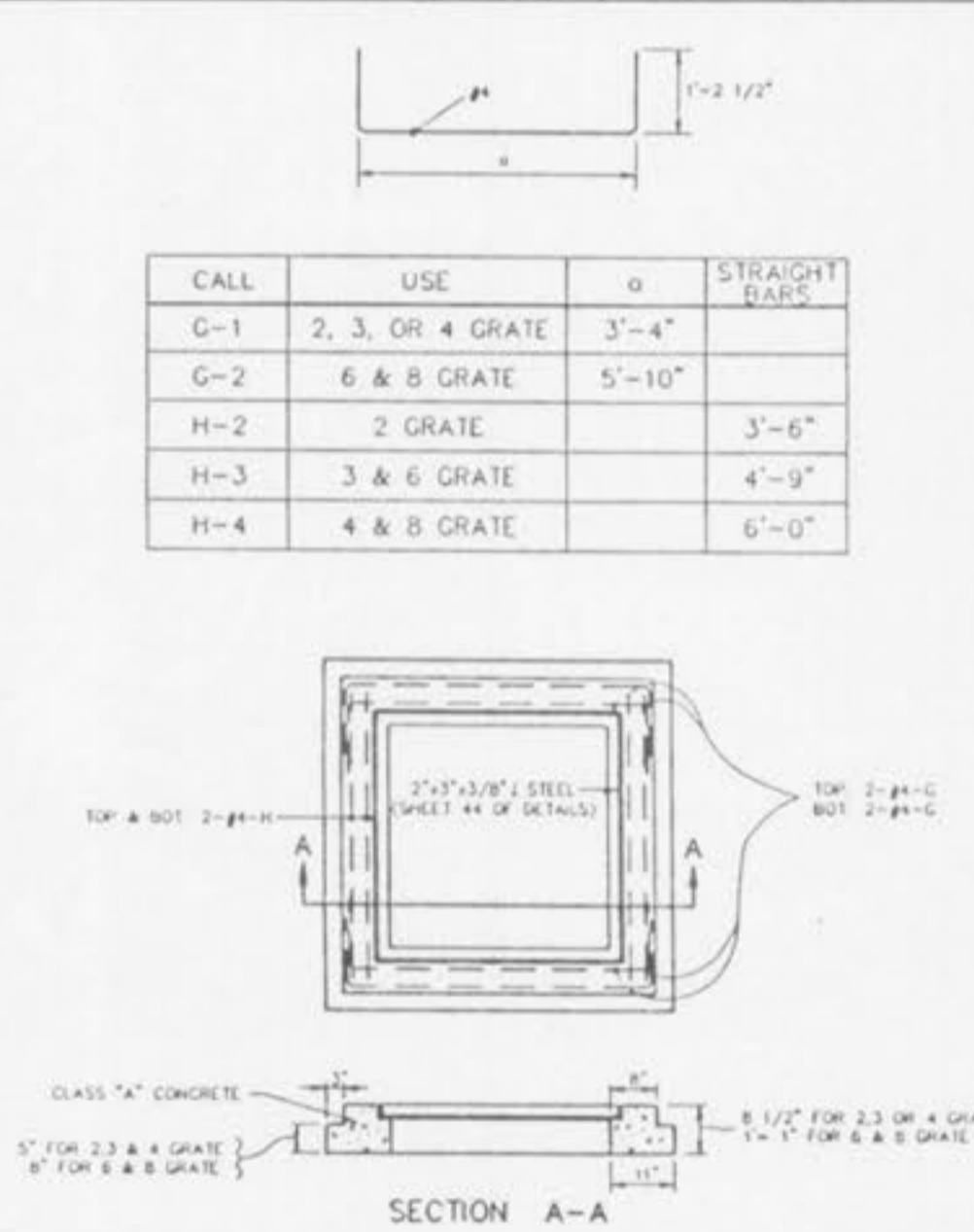

STEEL REQUIREMENTS FOR GRATE INLET SEAT  
 METROPOLITAN ST. LOUIS SEWER DISTRICT Standard Details of Sewer Construction  
 Dr. W.S.H. Ch. J.C.K. 1992 SHEET 46

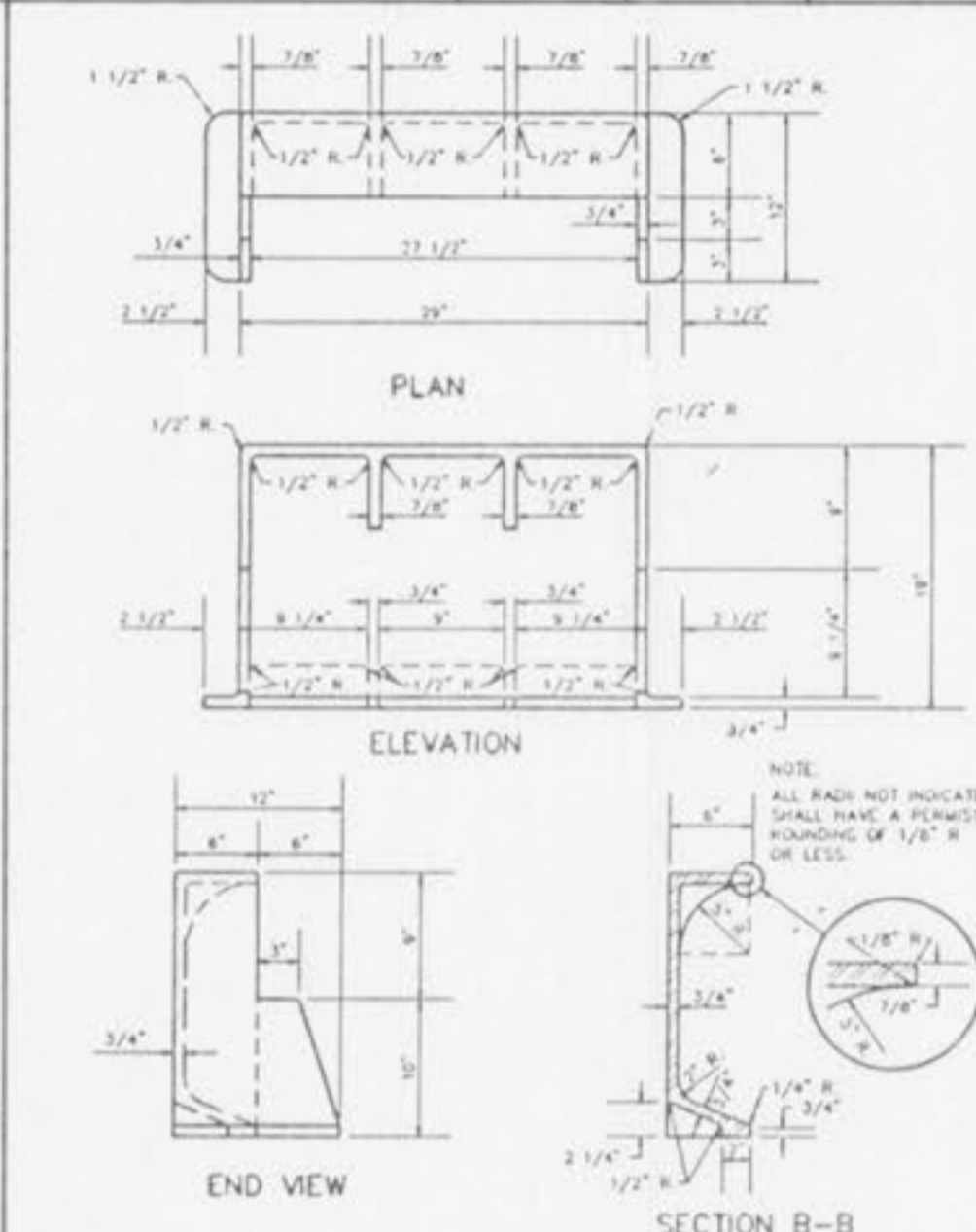

CAST IRON SIDE INTAKE UNIT FOR GRATED INLETS 249 LBS.  
 METROPOLITAN ST. LOUIS SEWER DISTRICT Standard Details of Sewer Construction  
 Dr. R.C.W. Ch. J.C.K. 1992 SHEET 47

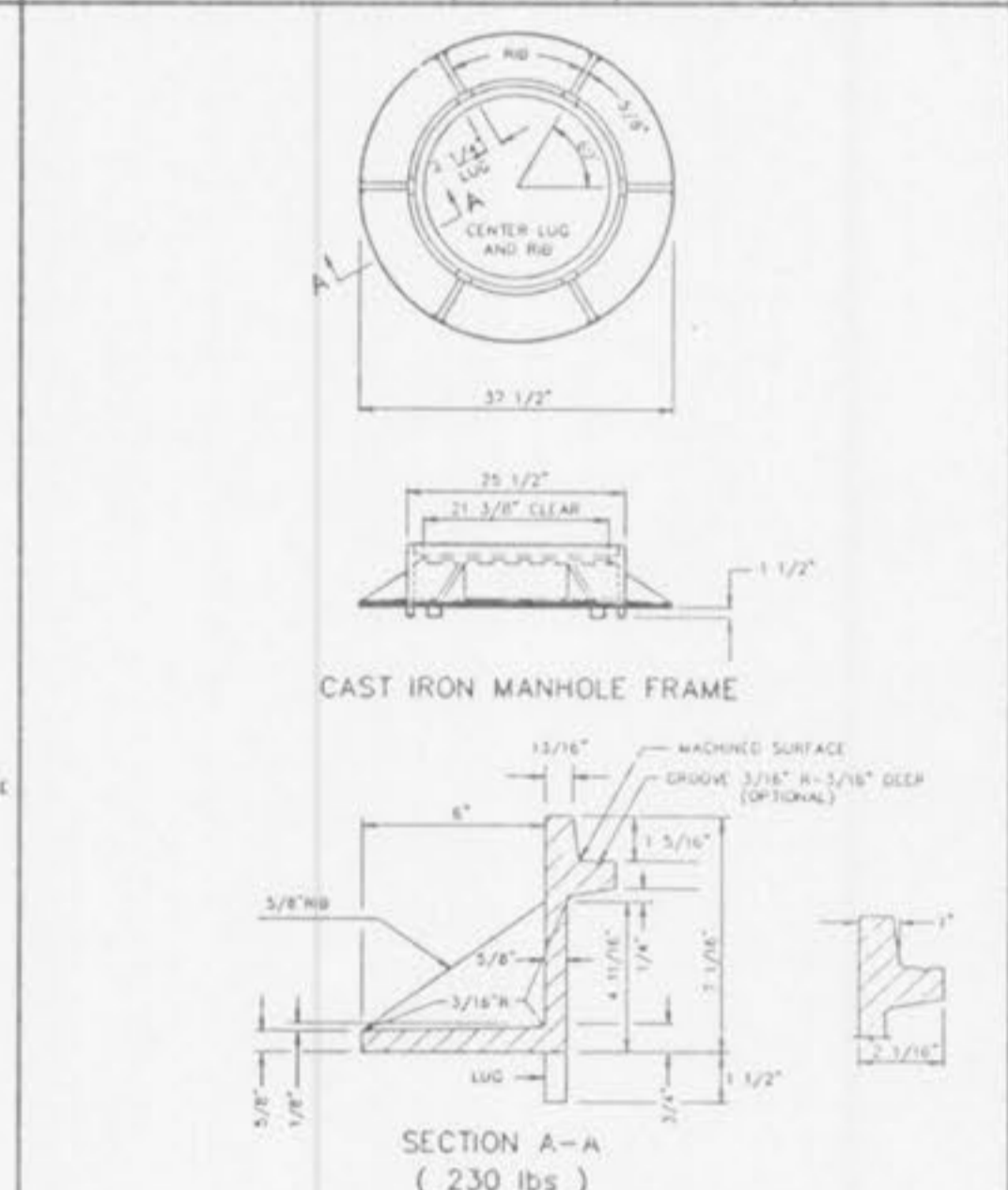

CAST IRON MANHOLE FRAME  
 METROPOLITAN ST. LOUIS SEWER DISTRICT Standard Details of Sewer Construction  
 Dr. D.A.B. Ch. J.C.K. 1992 SHEET 48

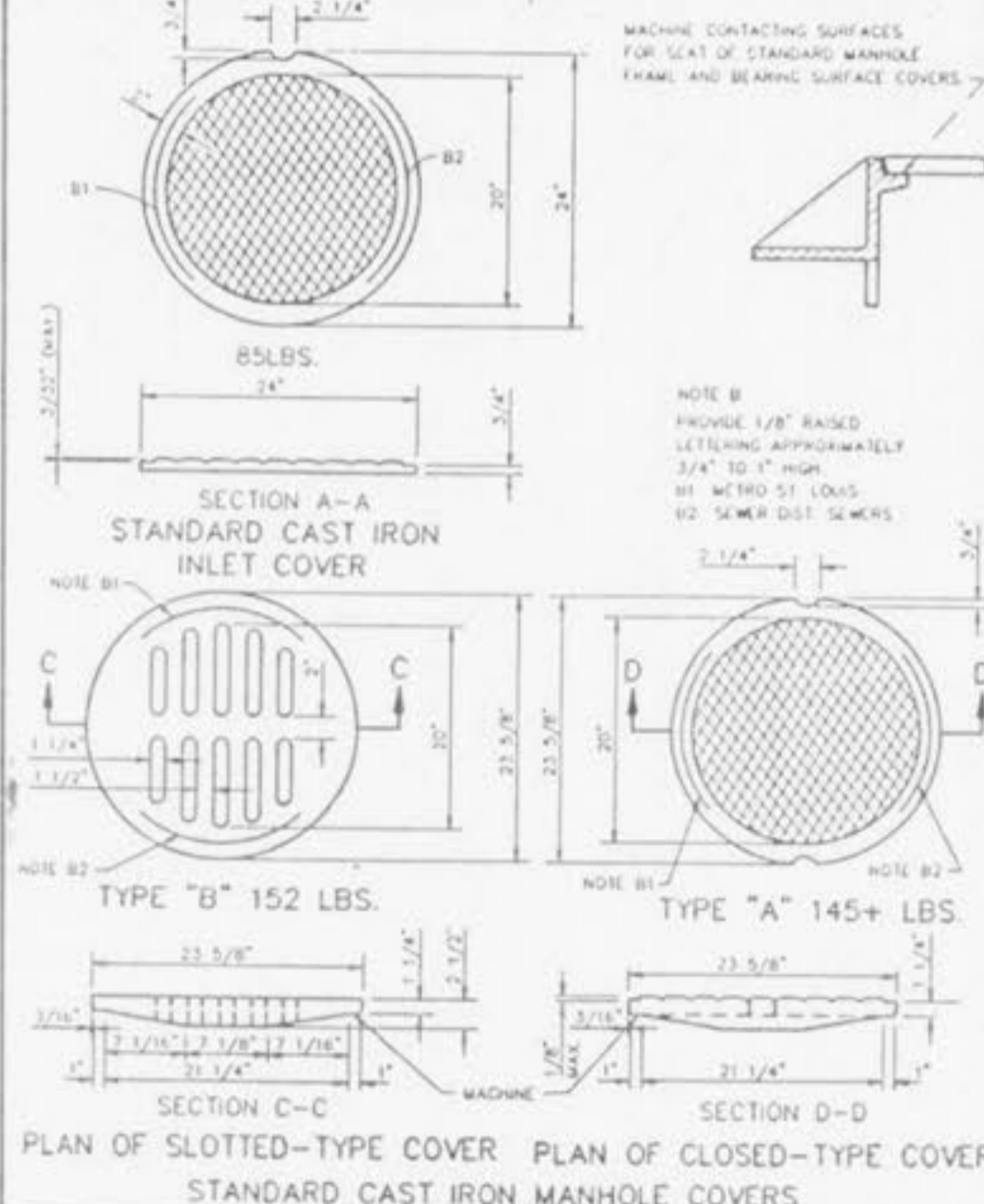

CAST IRON COVERS MANHOLES AND INLETS  
 METROPOLITAN ST. LOUIS SEWER DISTRICT Standard Details of Sewer Construction  
 Dr. R.C.W. Ch. J.C.K. 1992 SHEET 49

