

LOCKING DEVICE FOR TYPE "T" LOCK TYPE MANHOLE COVER
 METROPOLITAN ST. LOUIS SEWER DISTRICT
 Standard Details of Sewer Construction
 D. R. H. / S. A. M.
 Ch. J. C. K.
 2000 SHEET 53

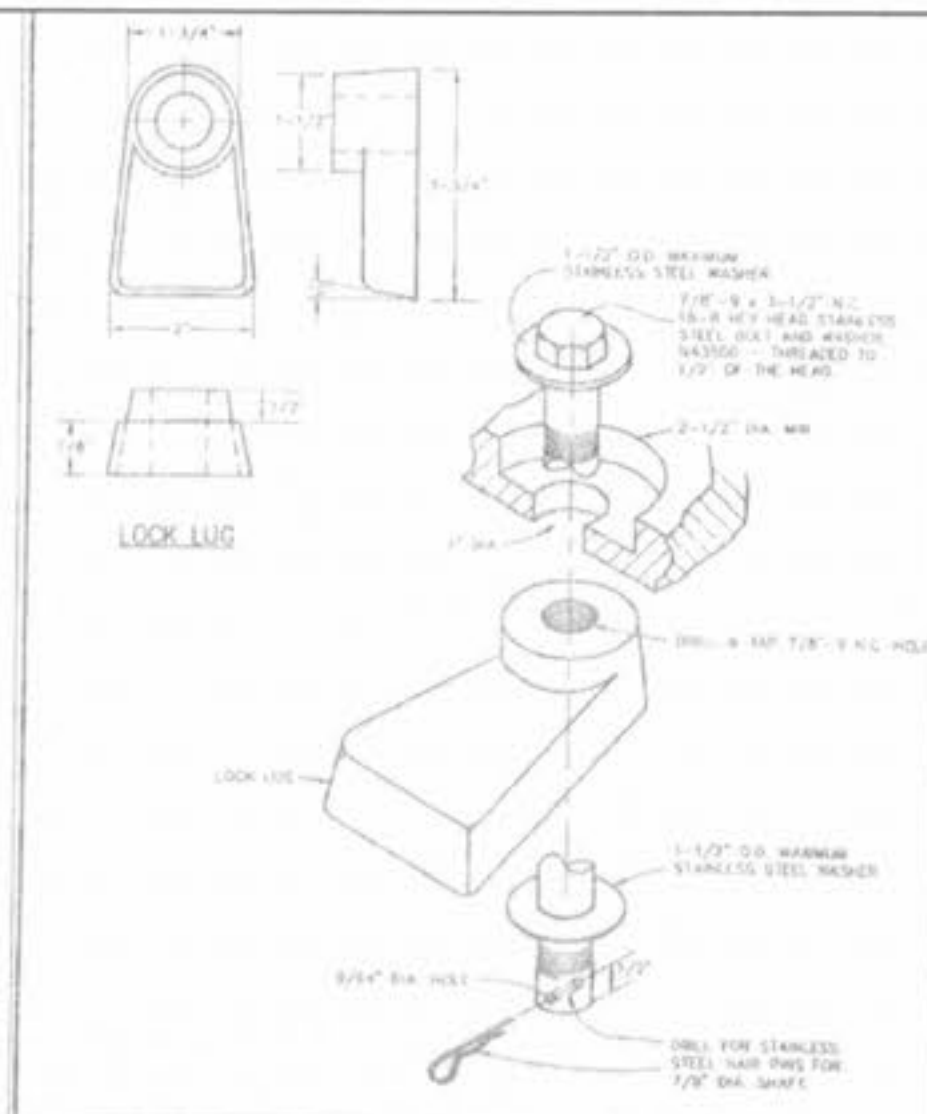

LOCKING DEVICE FOR TYPE "N" LOCK TYPE MANHOLE COVER
 METROPOLITAN ST. LOUIS SEWER DISTRICT
 Standard Details of Sewer Construction
 D. R. H. / S. A. M.
 Ch. J. C. K.
 2000 SHEET 56

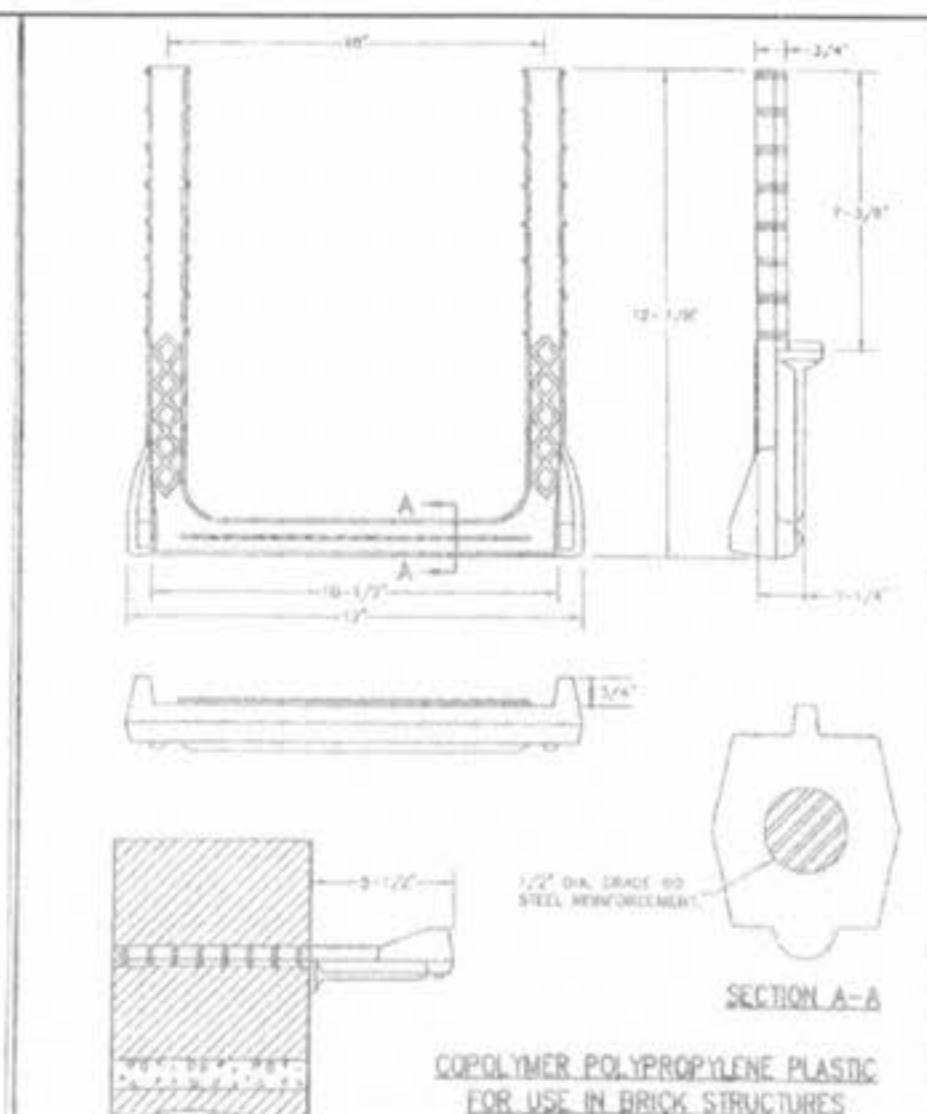

PST-B MANHOLE STEP INTO JOINT
 METROPOLITAN ST. LOUIS SEWER DISTRICT
 Standard Details of Sewer Construction
 D. R. H. / S. A. M.
 Ch. J. C. K.
 2000 SHEET 57

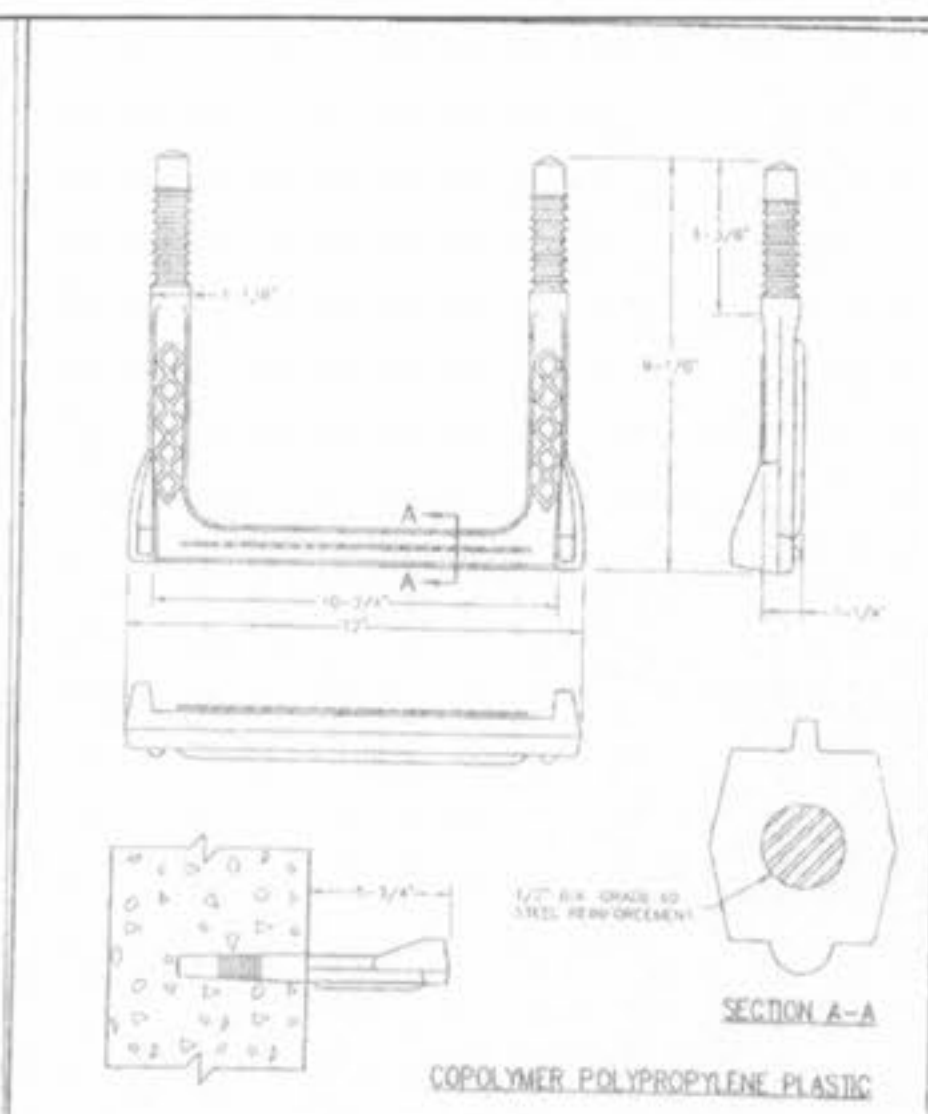

MANHOLE STEP FOR PRECAST & CAST-IN-PLACE MANHOLE
 METROPOLITAN ST. LOUIS SEWER DISTRICT
 Standard Details of Sewer Construction
 D. R. H. / S. A. M.
 Ch. J. C. K.
 2000 SHEET 58

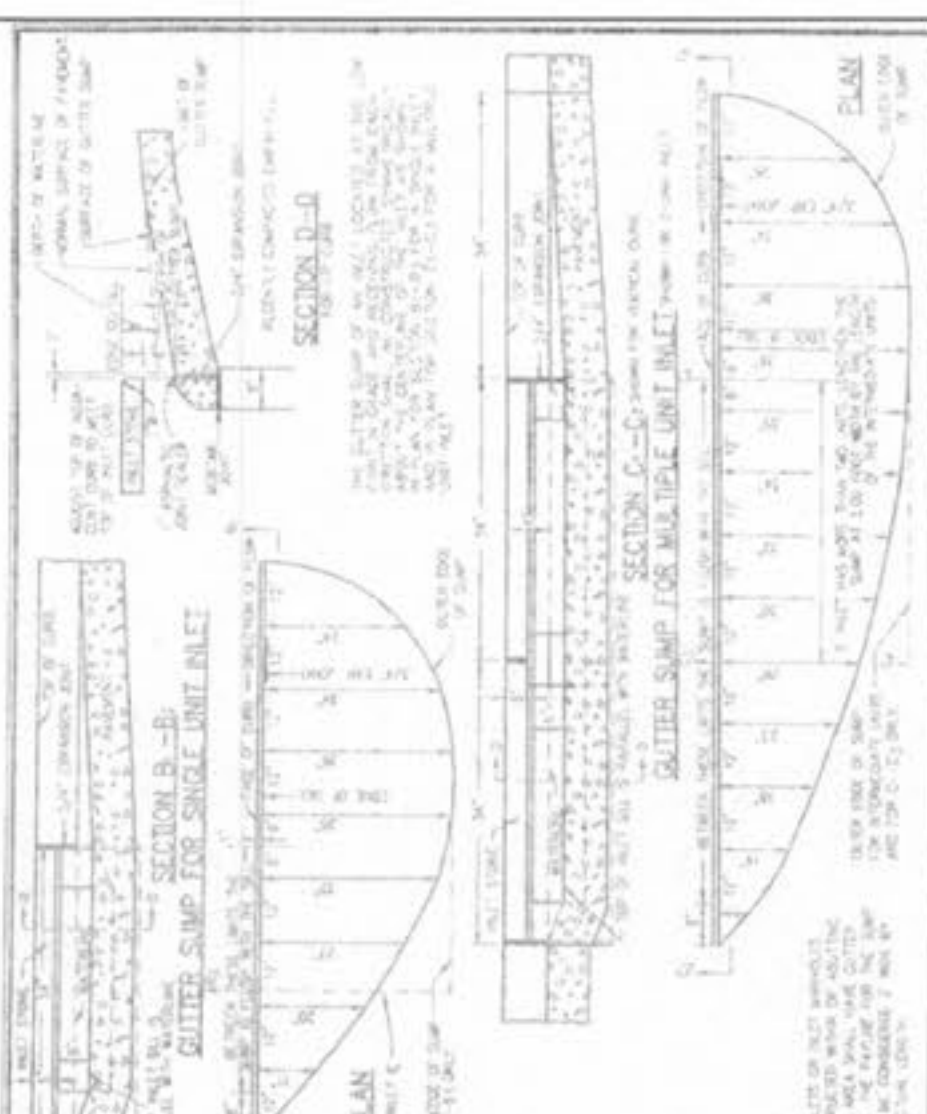

GUTTER SUMPS FOR VERTICAL CURB
 METROPOLITAN ST. LOUIS SEWER DISTRICT
 Standard Details of Sewer Construction
 D. R. H. / S. A. M.
 Ch. J. C. K.
 2000 SHEET 58

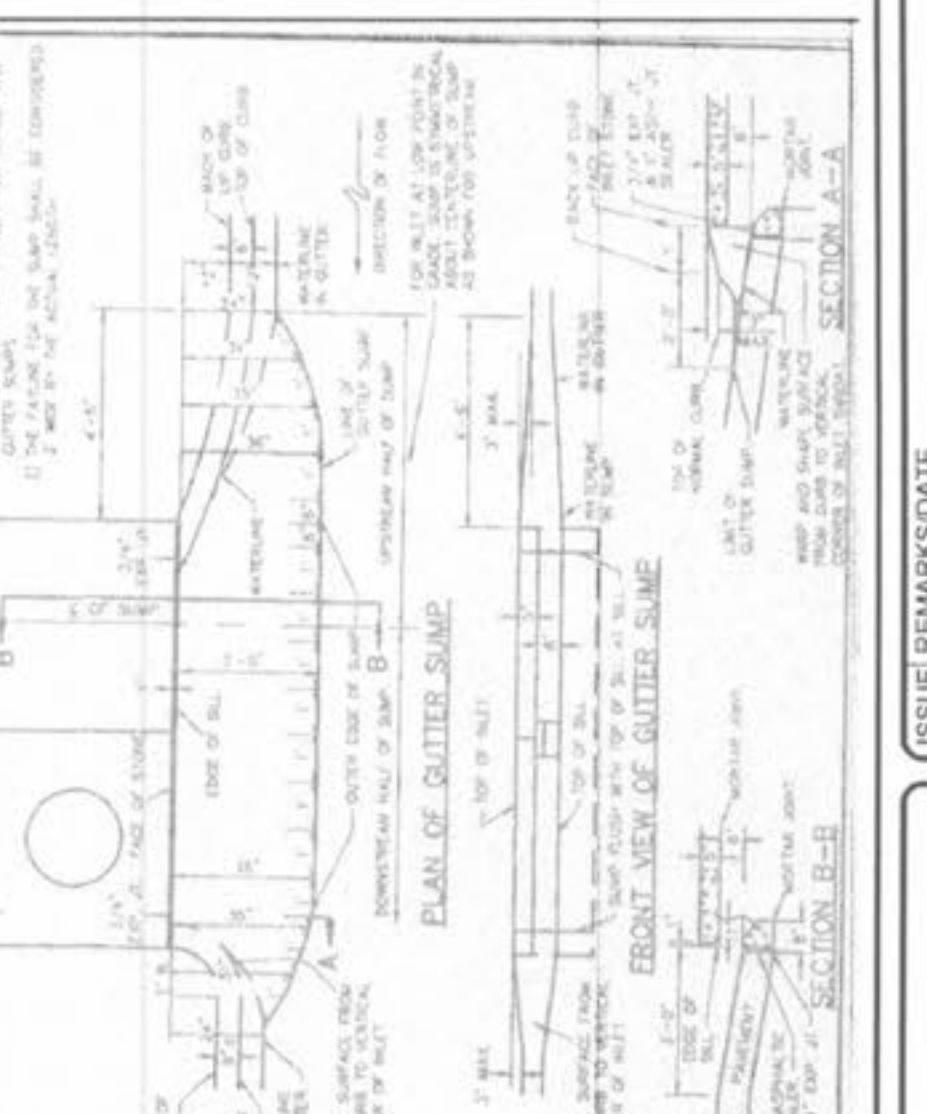

GUTTER SUMP FOR LIP CURB
 METROPOLITAN ST. LOUIS SEWER DISTRICT
 Standard Details of Sewer Construction
 D. R. H. / S. A. M.
 Ch. J. C. K.
 2000 SHEET 60

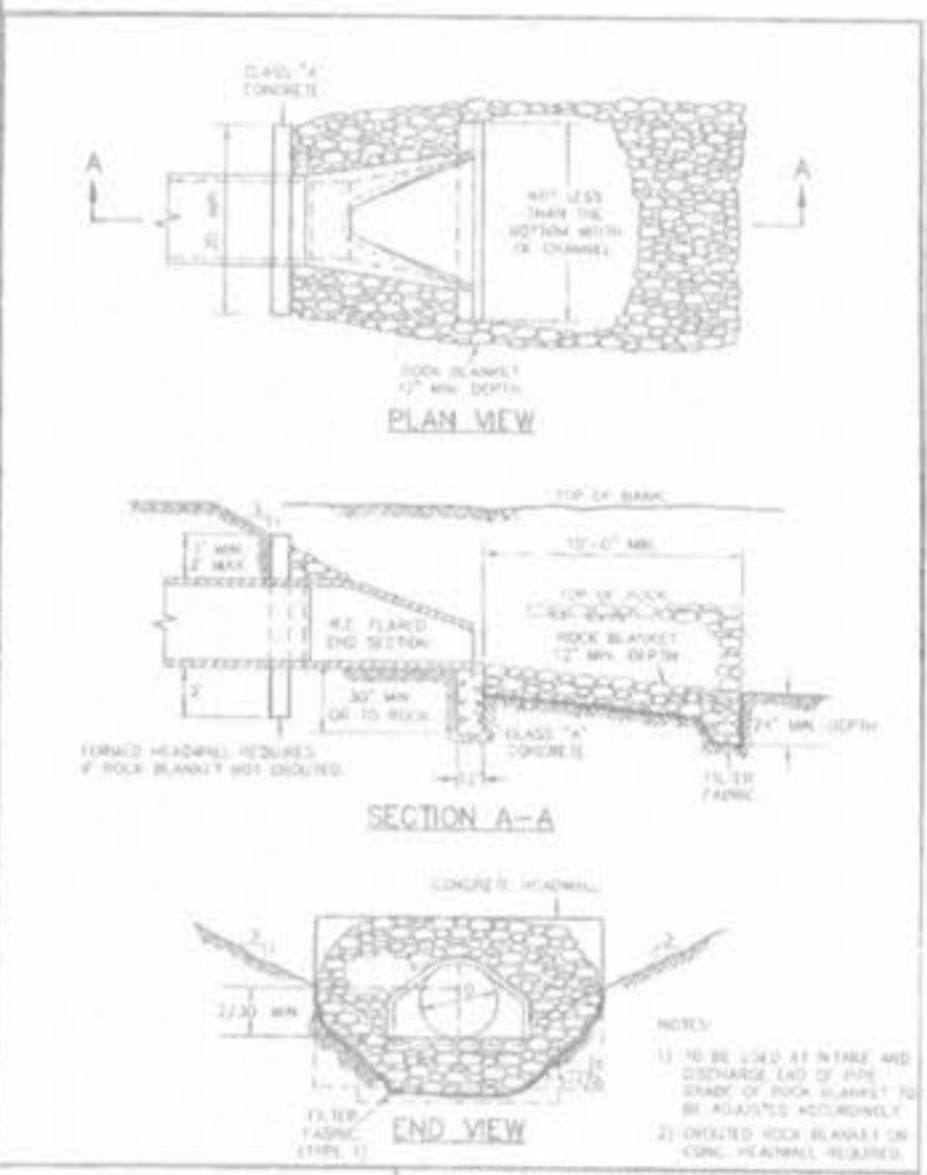

FLARED END SECTION
 METROPOLITAN ST. LOUIS SEWER DISTRICT
 Standard Details of Sewer Construction
 D. R. H. / S. A. M.
 Ch. J. C. K.
 2000 SHEET 61

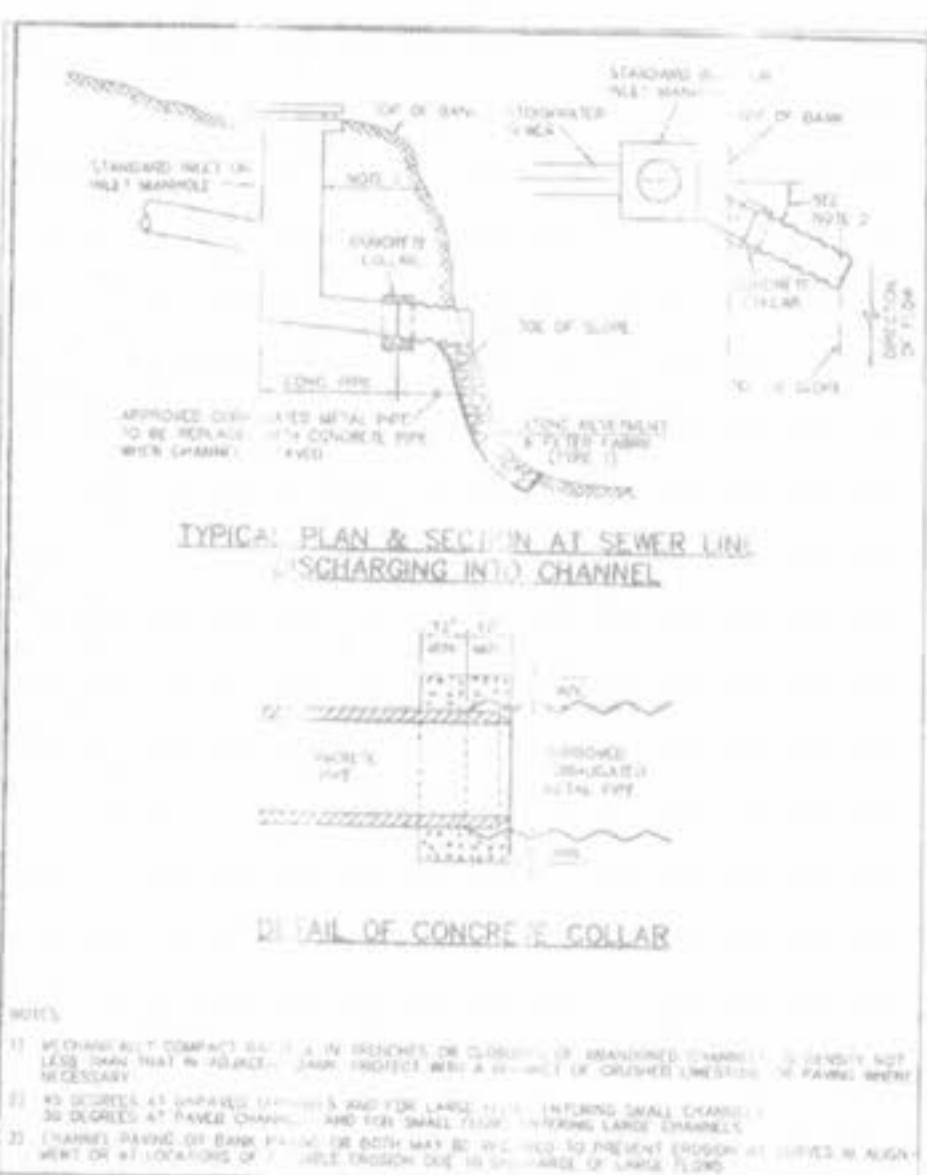

STORMWATER CHANNEL
 METROPOLITAN ST. LOUIS SEWER DISTRICT
 Standard Details of Sewer Construction
 D. R. H. / S. A. M.
 Ch. J. C. K.
 2000 SHEET 62

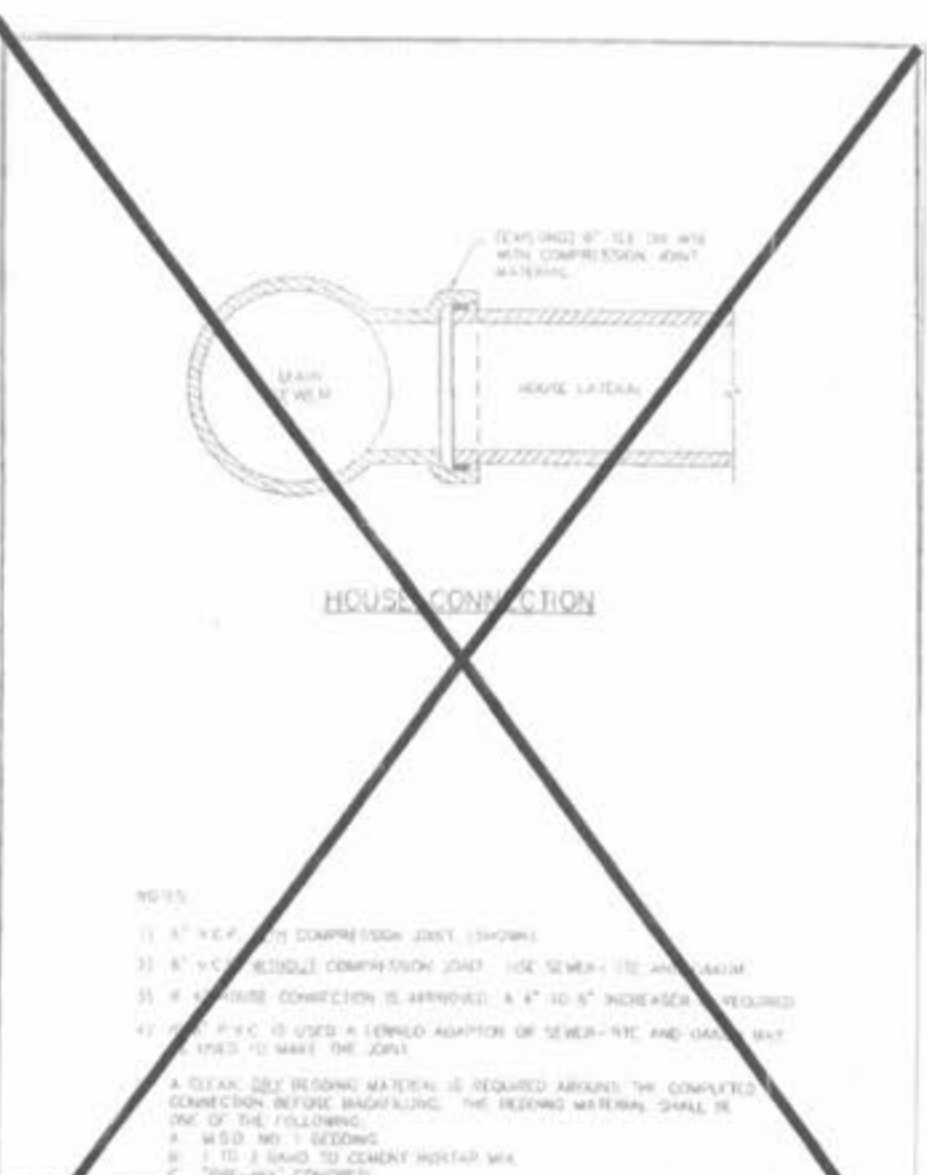

HOUSE CONNECTION TO EXISTING TEE OR WYE
 METROPOLITAN ST. LOUIS SEWER DISTRICT
 Standard Details of Sewer Construction
 D. R. H. / S. A. M.
 Ch. J. C. K.
 2000 SHEET 63

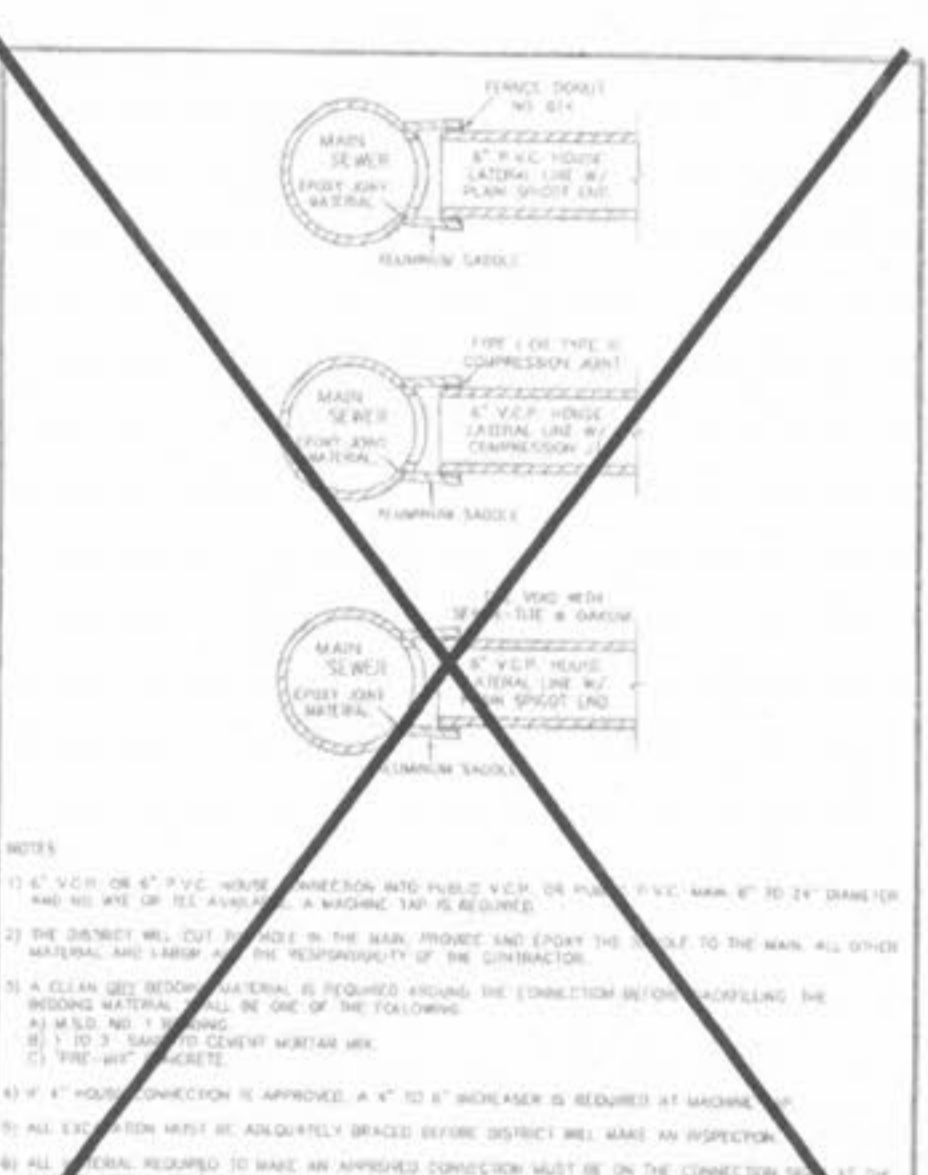

MACHINE TAP
 METROPOLITAN ST. LOUIS SEWER DISTRICT
 Standard Details of Sewer Construction
 D. R. H. / S. A. M.
 Ch. J. C. K.
 2000 SHEET 64

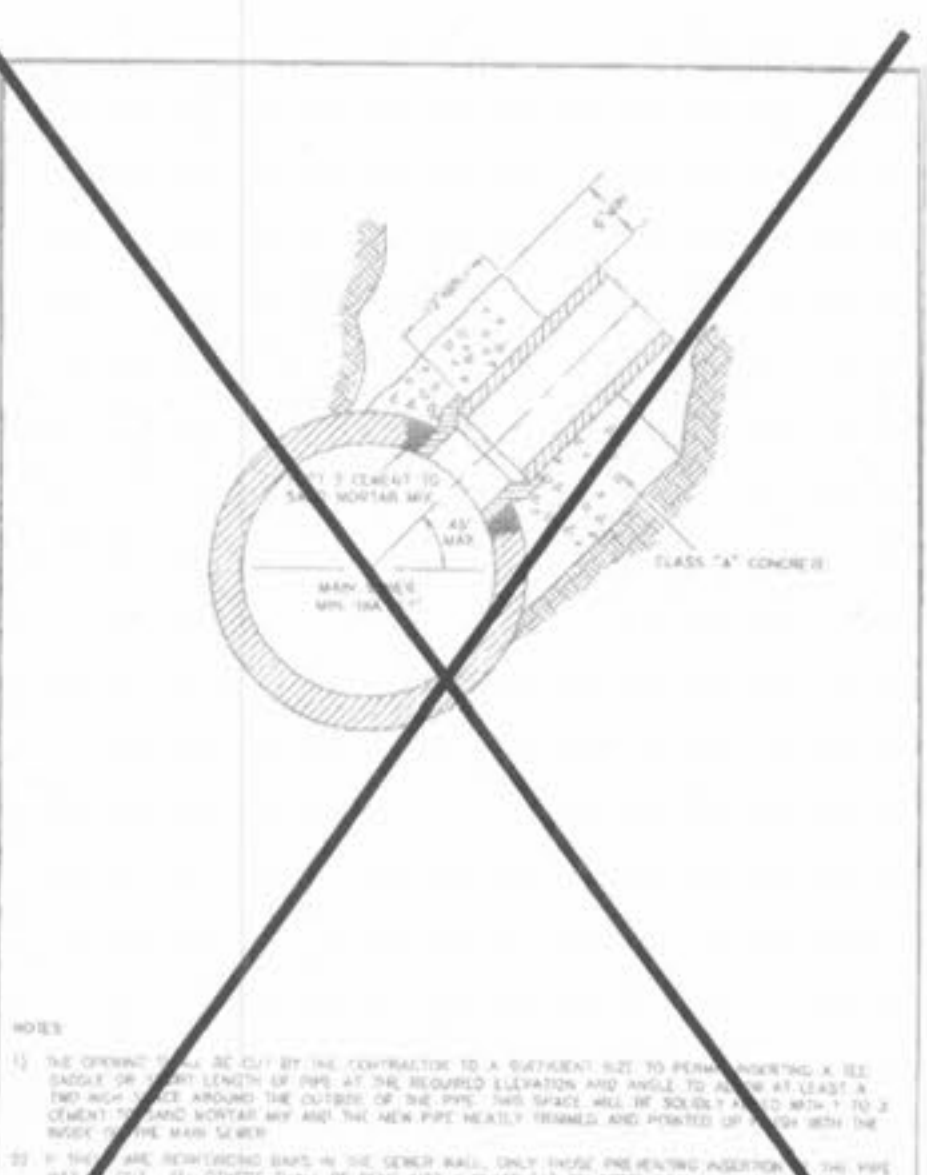

HOUSE CONNECTIONS ALLOWED BY TEE SADDLE
 METROPOLITAN ST. LOUIS SEWER DISTRICT
 Standard Details of Sewer Construction
 D. R. H. / S. A. M.
 Ch. J. C. K.
 2000 SHEET 65

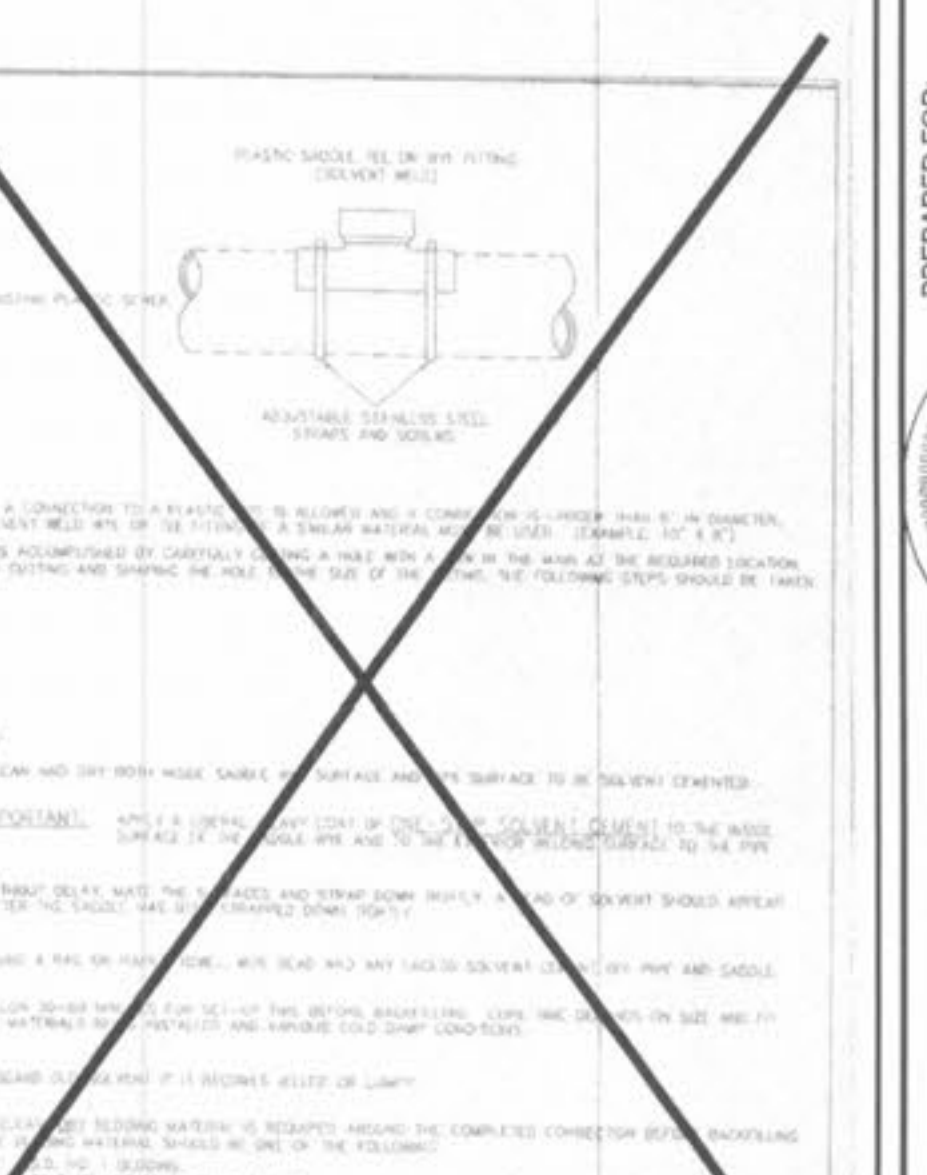

(8" LARGER) CONNECTION TO PLASTIC MAIN
 METROPOLITAN ST. LOUIS SEWER DISTRICT
 Standard Details of Sewer Construction
 D. R. H. / S. A. M.
 Ch. J. C. K.
 2000 SHEET 66

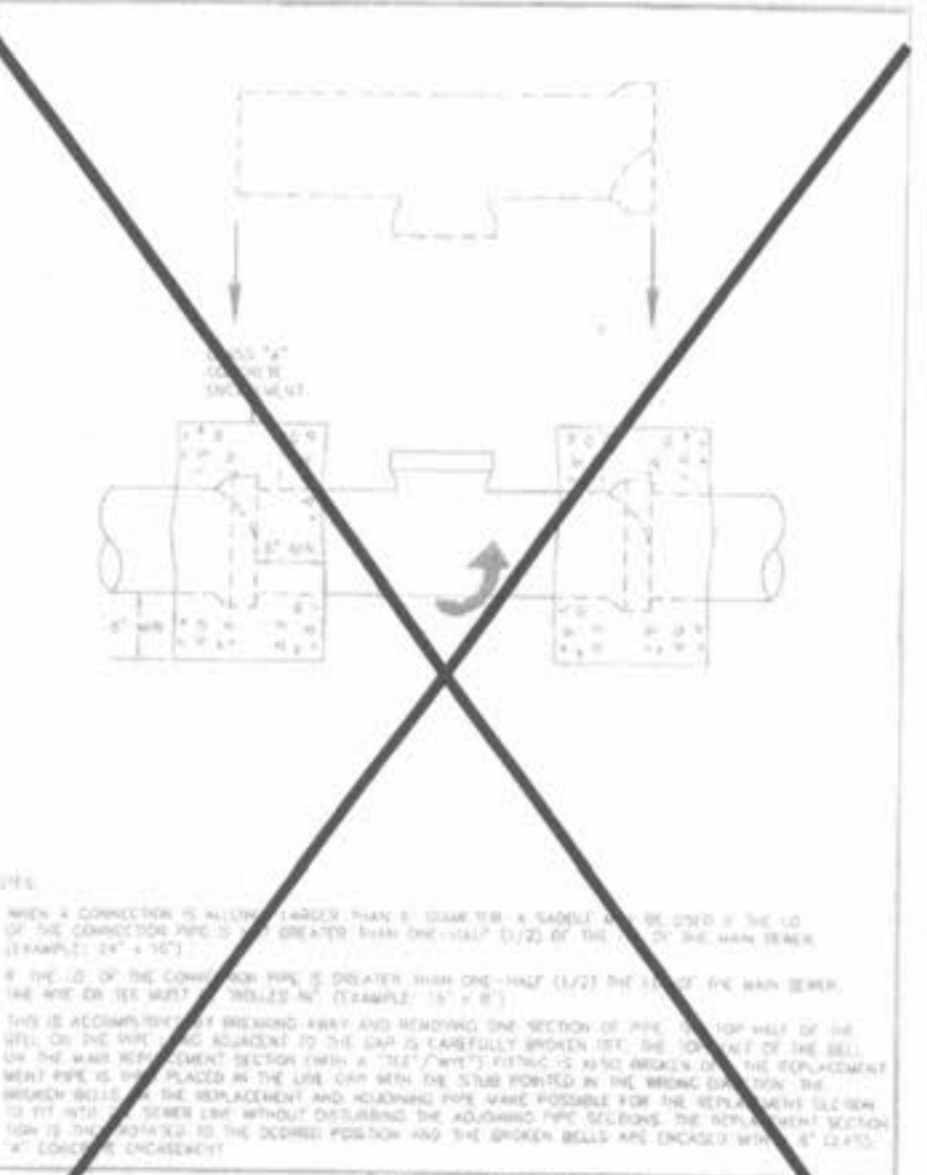

"KILL-IN" FOR EXISTING CLAY OR CONCRETE PIPE
 METROPOLITAN ST. LOUIS SEWER DISTRICT
 Standard Details of Sewer Construction
 D. R. H. / S. A. M.
 Ch. J. C. K.
 2000 SHEET 67

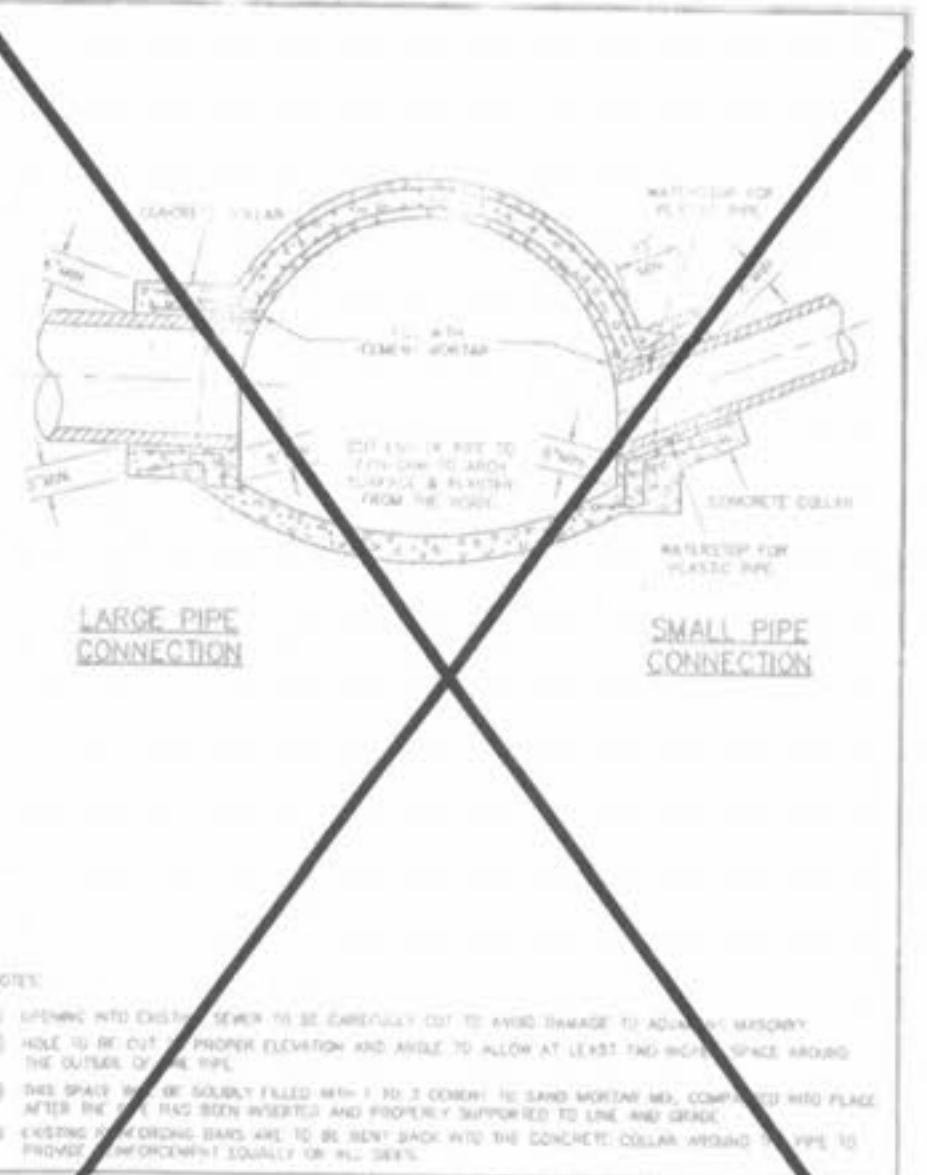

CONNECTIONS TO LARGE SEWERS
 METROPOLITAN ST. LOUIS SEWER DISTRICT
 Standard Details of Sewer Construction
 D. R. H. / S. A. M.
 Ch. J. C. K.
 2000 SHEET 68

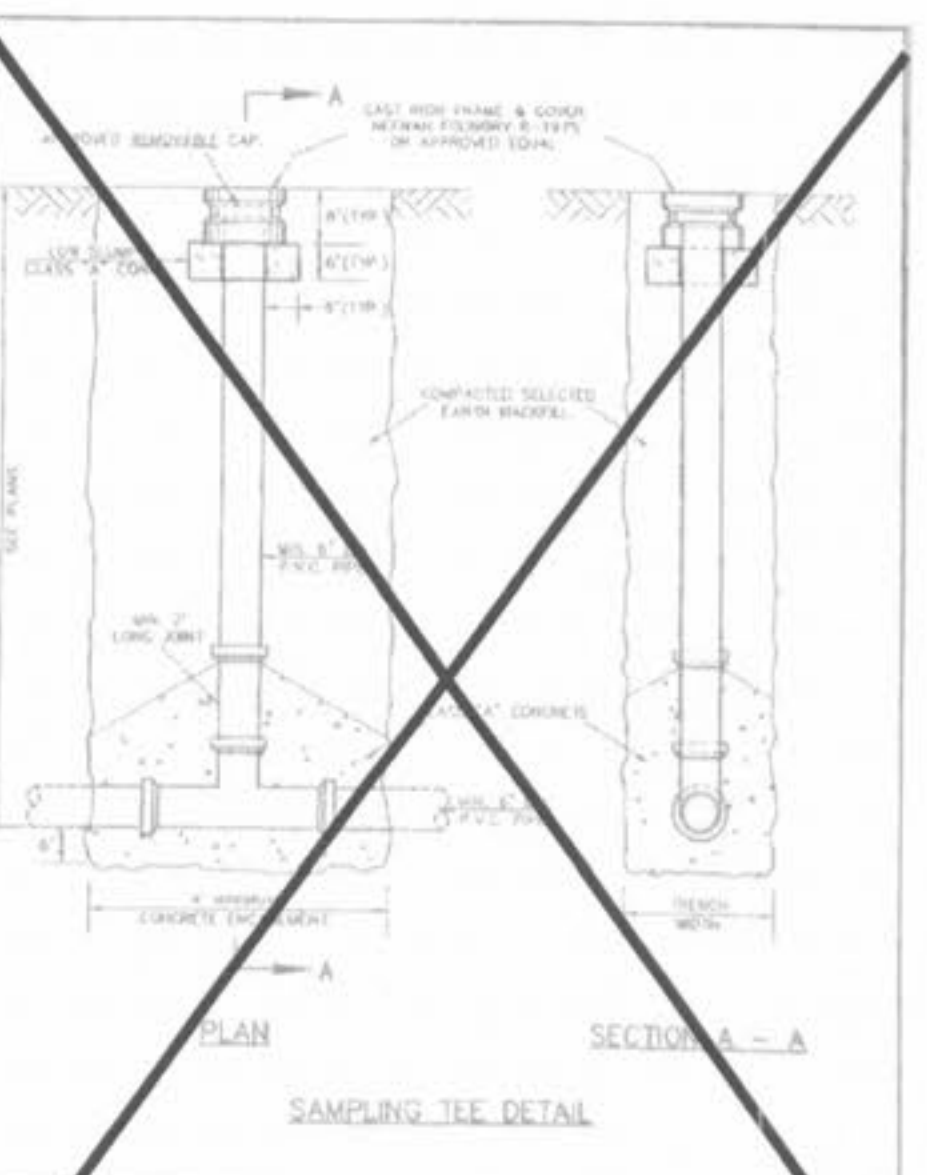

SAMPLING TEE
 METROPOLITAN ST. LOUIS SEWER DISTRICT
 Standard Details of Sewer Construction
 D. R. H. / S. A. M.
 Ch. J. C. K.
 2000 SHEET 69

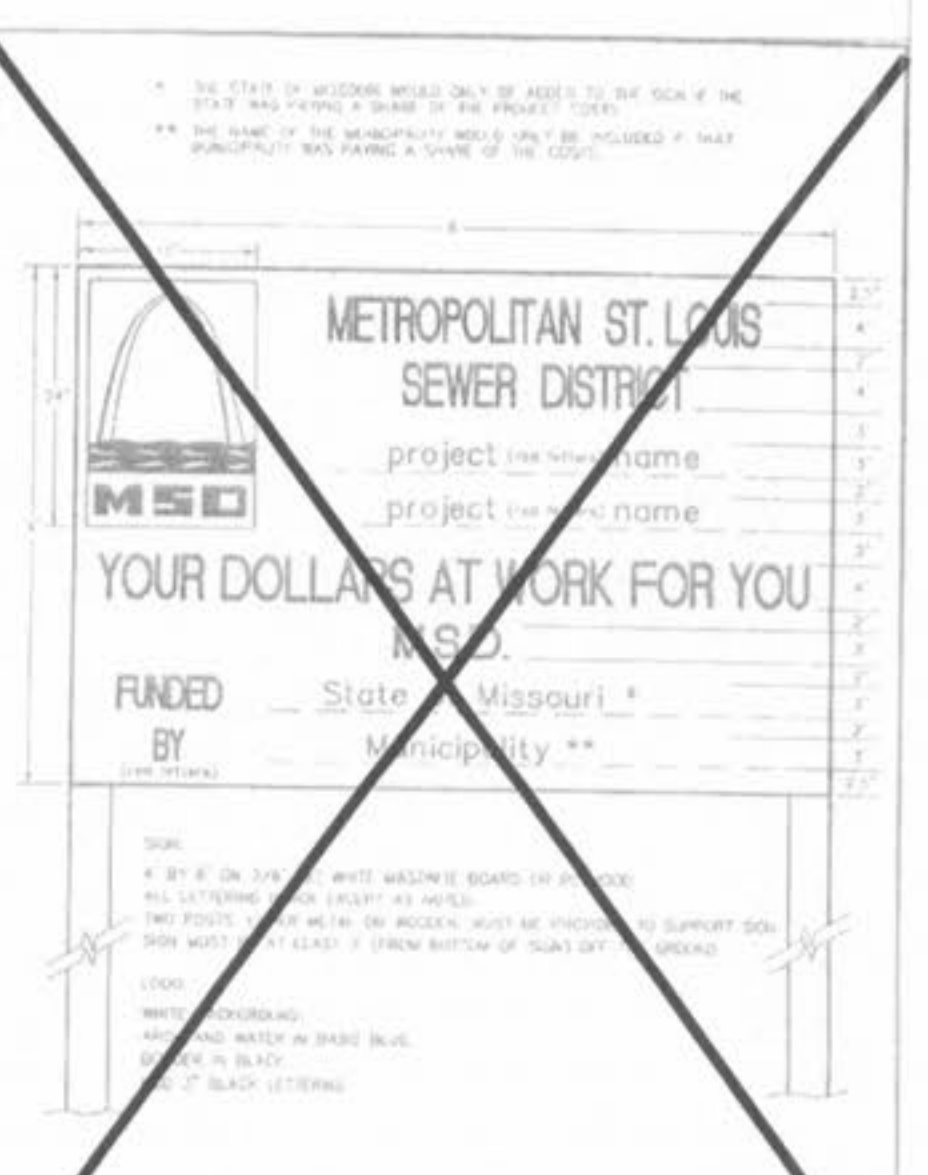

SIGNS
 METROPOLITAN ST. LOUIS SEWER DISTRICT
 Standard Details of Sewer Construction
 D. R. H. / S. A. M.
 Ch. J. C. K.
 2000 SHEET 70

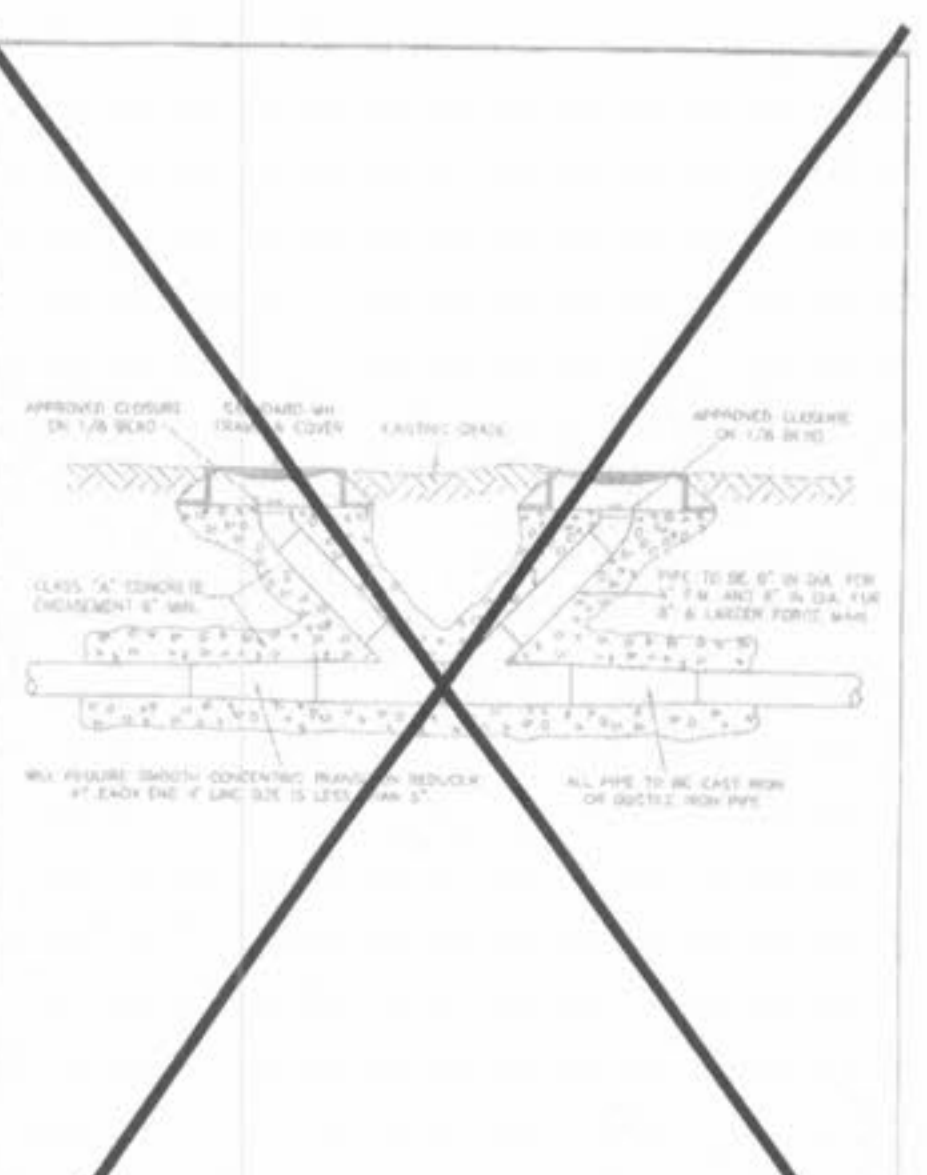

FORCE MAIN CLEANOUT (6" DIA. & SMALLER)
 METROPOLITAN ST. LOUIS SEWER DISTRICT
 Standard Details of Sewer Construction
 D. R. H. / S. A. M.
 Ch. J. C. K.
 2000 SHEET 71

ISSUE	REMARKS/DATE
1	03-02-05 FIRST SUBMITTAL
2	04-04-05 REVISED PER DCSD COMMENTS
3	05-23-05 REVISED PER CITY OF FALLON COMMENTS
4	05-27-05 REVISED PER DCSD COMMENTS
5	06-09-05 REVISED PER PASWOMZ COMMENTS
6	06-27-05 REVISED PER CITY OF FALLON COMMENTS
7	07-14-05 REVISED PER PASWOMZ COMMENTS
8	08-08-05 REVISED PER CITY OF FALLON COMMENTS

PREPARED FOR:
SPRINGHURST, L.L.C.
 5091 NEW BAUMGARTNER ROAD
 ST. LOUIS, MISSOURI 63129
 (314) 487-6777



THE **STERLING** CO.
 ENGINEERS & SURVEYORS
 5055 NEW BAUMGARTNER ROAD
 ST. LOUIS, MISSOURI 63129
 (314) 487-0440 FAX 487-8944
 E-Mail: Sterling@sterling-eng-sur.com

PROJECT: **THE VILLAGES AT SPRINGHURST**
 SHEET TITLE: **MSD CONSTRUCTION DETAILS**

NO. **03 12 269**
 M.S.D. SHEET
 P# **CD7**
 DIGITAL FILE LOCATION: **SEWER-STERLING-2**
 SHEET OF

BASE MAP