

**INSIDE FOULWATER DROP MANHOLE (FOR FREE-FALL)**  
 METROPOLITAN ST. LOUIS SEWER DISTRICT  
 Standard Details of Sewer Construction  
 SHEET 19

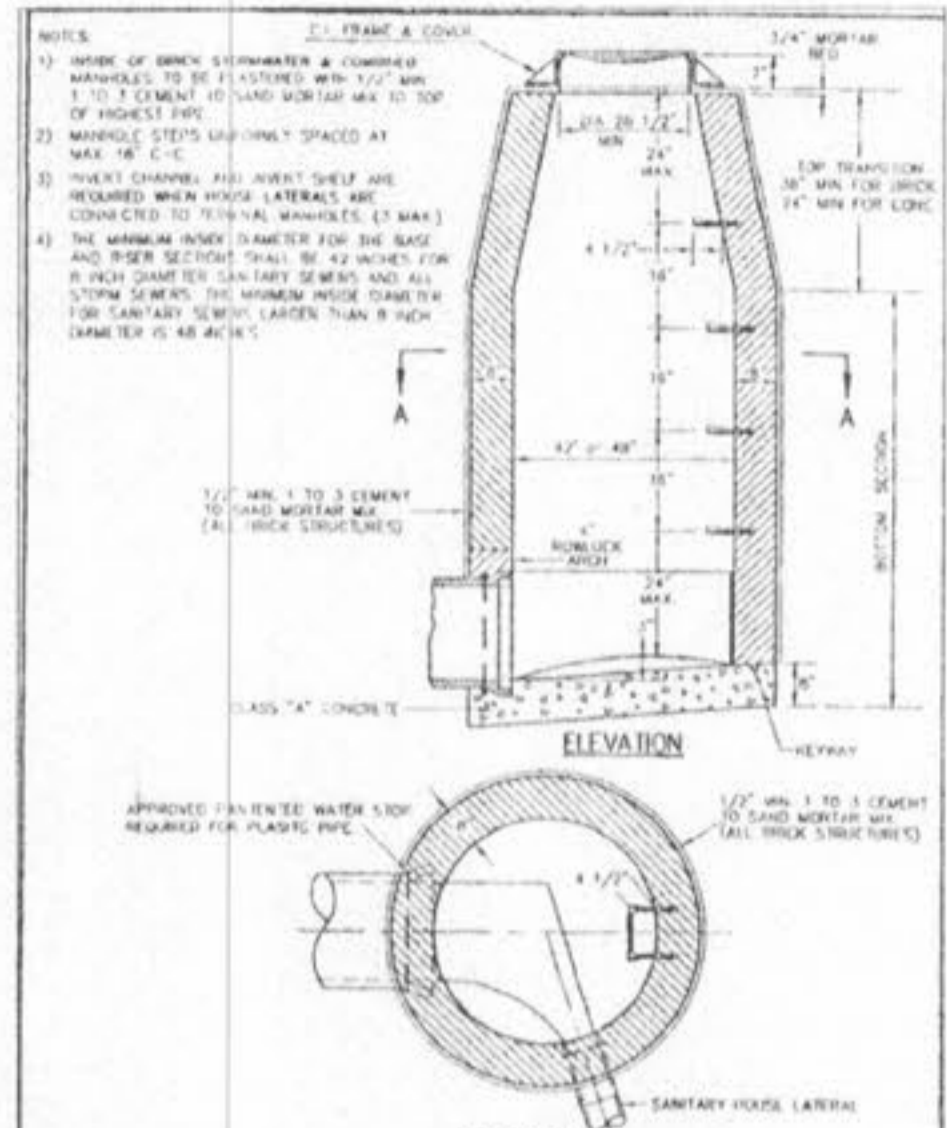

**TERMINAL MANHOLE**  
 METROPOLITAN ST. LOUIS SEWER DISTRICT  
 Standard Details of Sewer Construction  
 SHEET 20

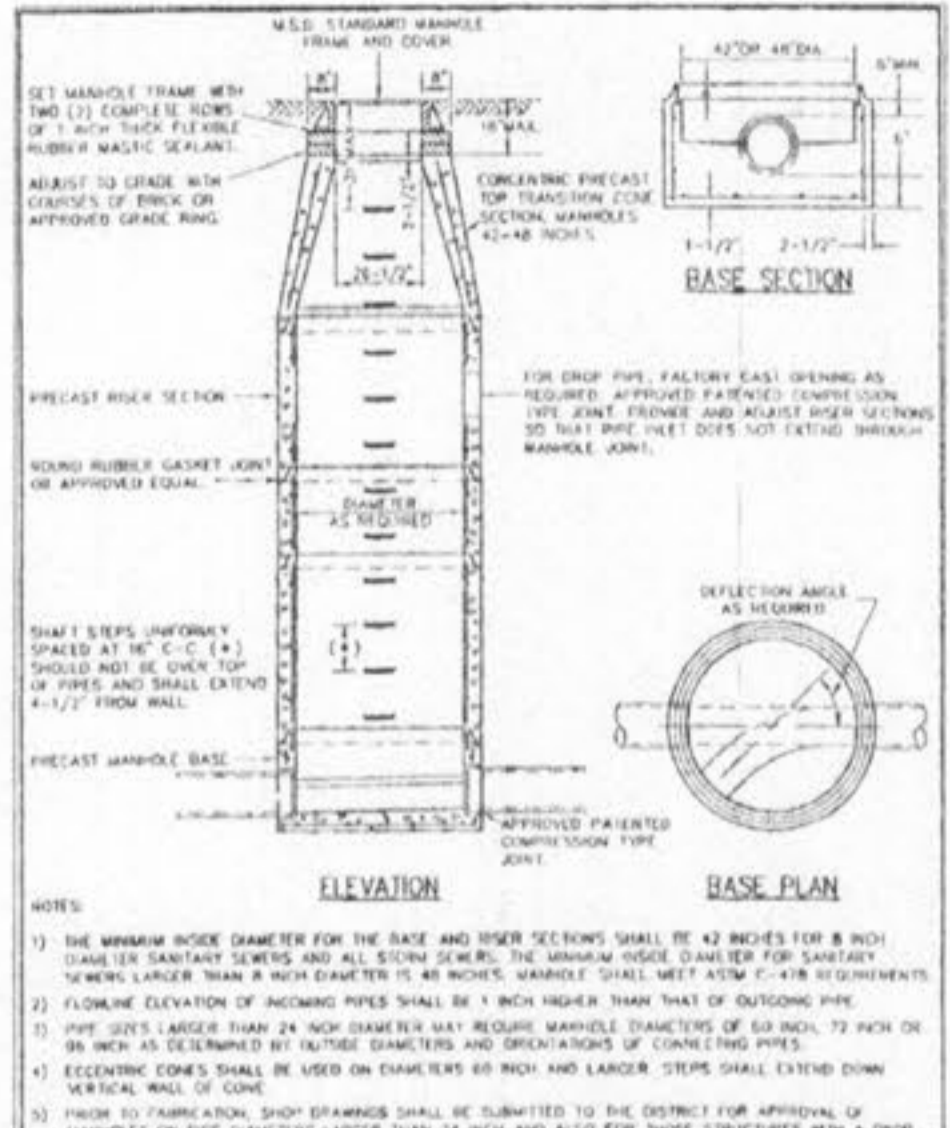

**PRECAST CONCRETE MANHOLE**  
 METROPOLITAN ST. LOUIS SEWER DISTRICT  
 Standard Details of Sewer Construction  
 SHEET 21

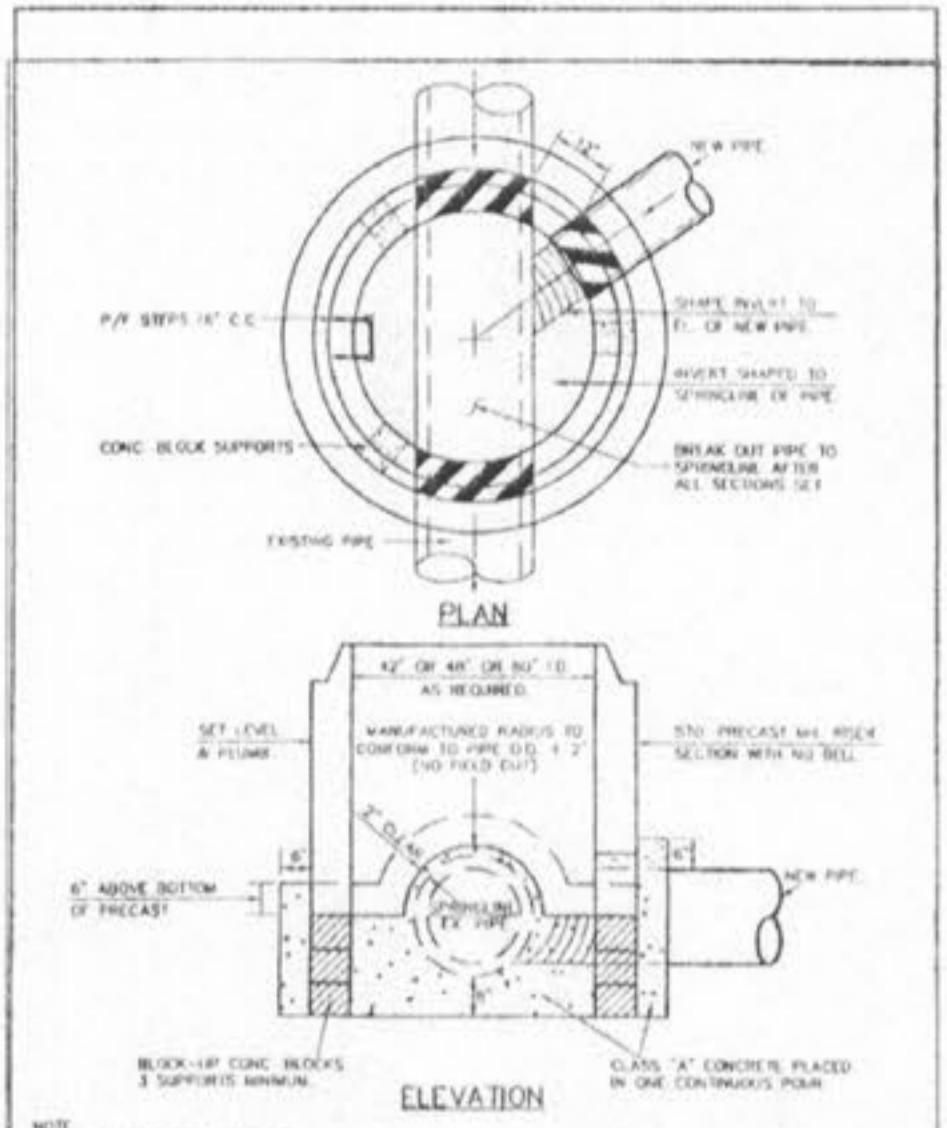

**PRECAST MANHOLE ON EXIST. PIPE W/CONTINUOUS FLOW ONLY**  
 METROPOLITAN ST. LOUIS SEWER DISTRICT  
 Standard Details of Sewer Construction  
 SHEET 22

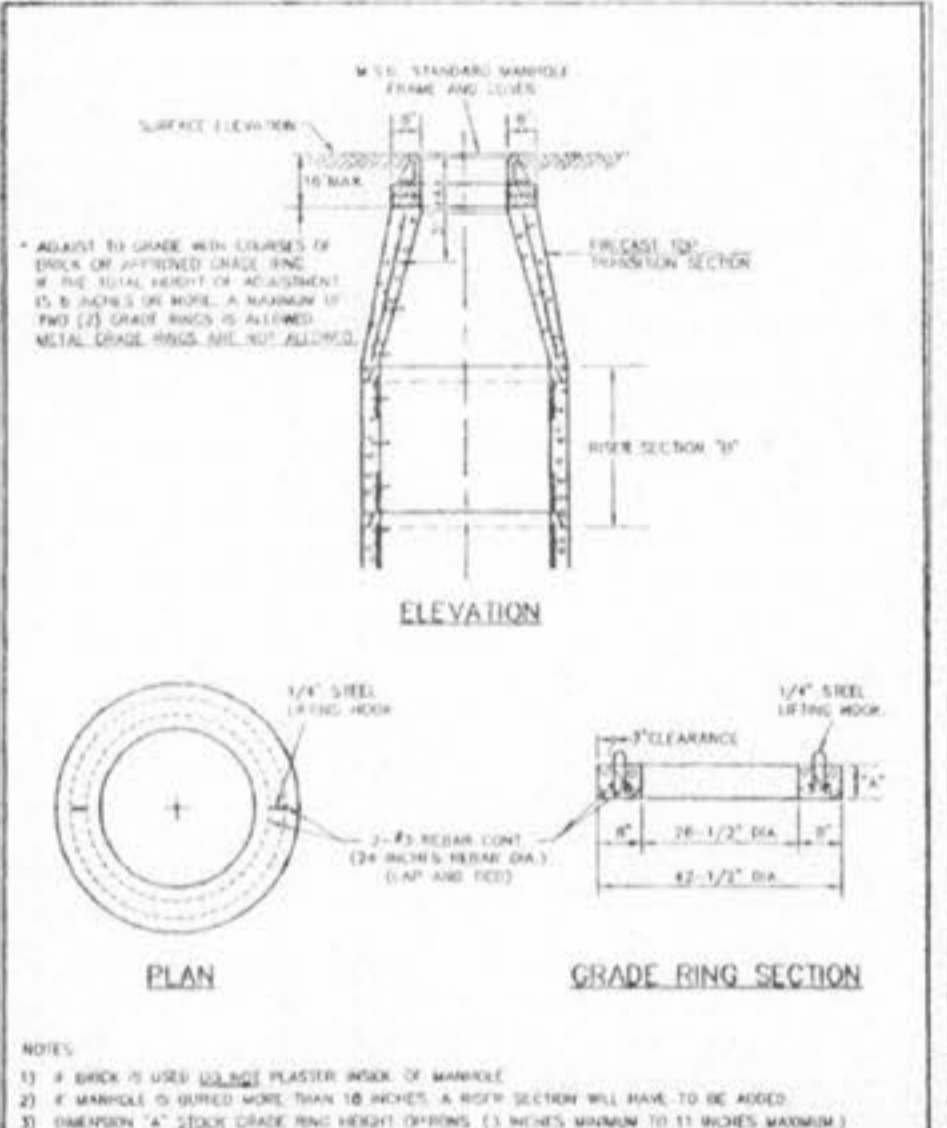

**ADJUST TO GRADE**  
 METROPOLITAN ST. LOUIS SEWER DISTRICT  
 Standard Details of Sewer Construction  
 SHEET 23

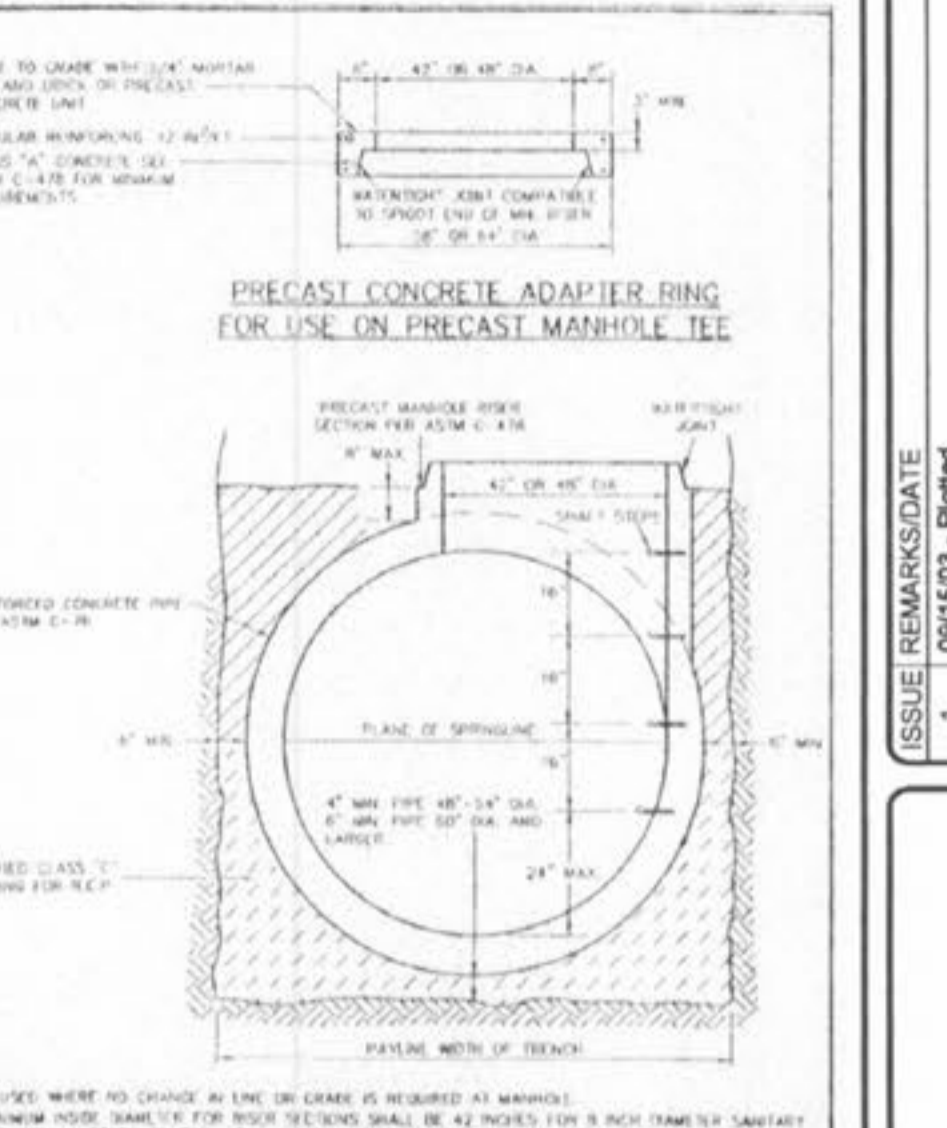

**PRECAST CONCRETE ADAPTER RING FOR USE ON PRECAST MANHOLE TEE**  
 METROPOLITAN ST. LOUIS SEWER DISTRICT  
 Standard Details of Sewer Construction  
 SHEET 24

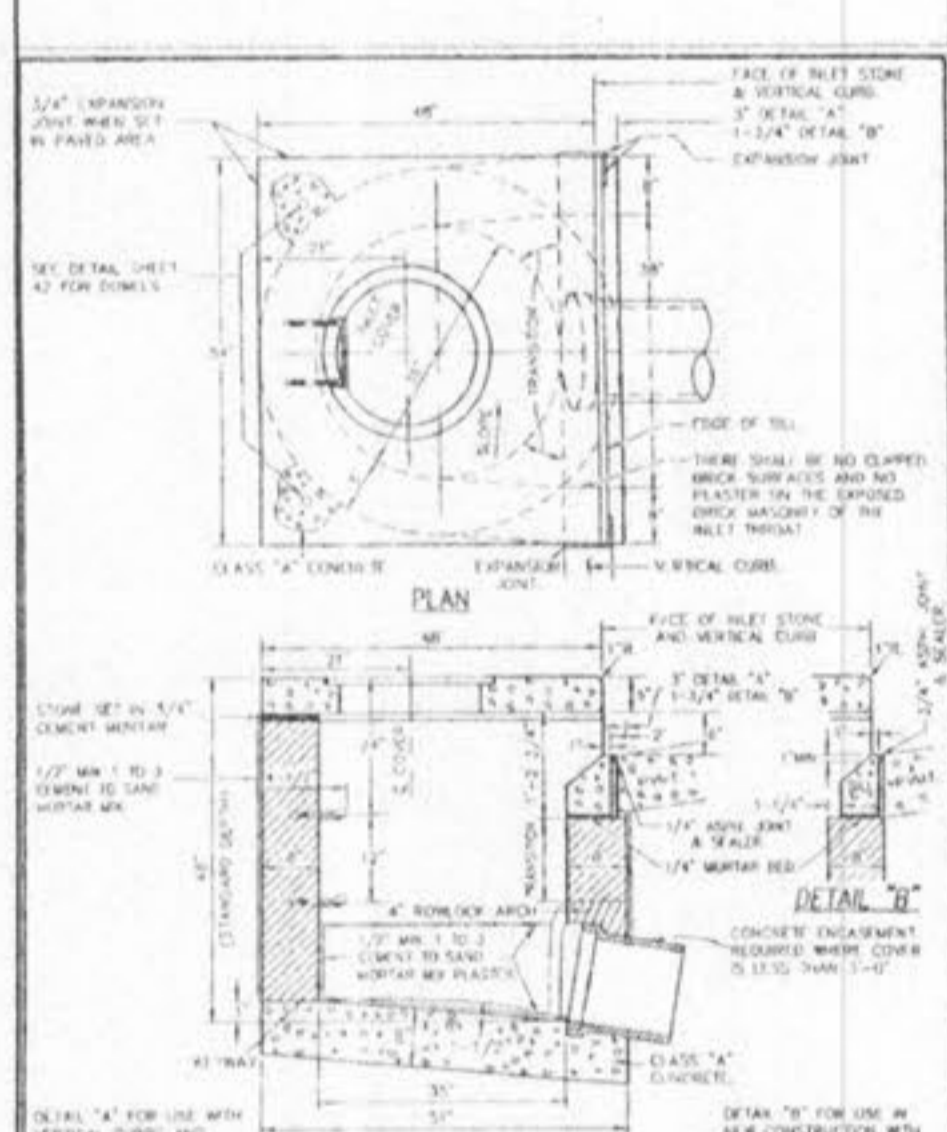

**UNTRAPPED STREET INLET BRICK CONSTRUCTION**  
 METROPOLITAN ST. LOUIS SEWER DISTRICT  
 Standard Details of Sewer Construction  
 SHEET 25

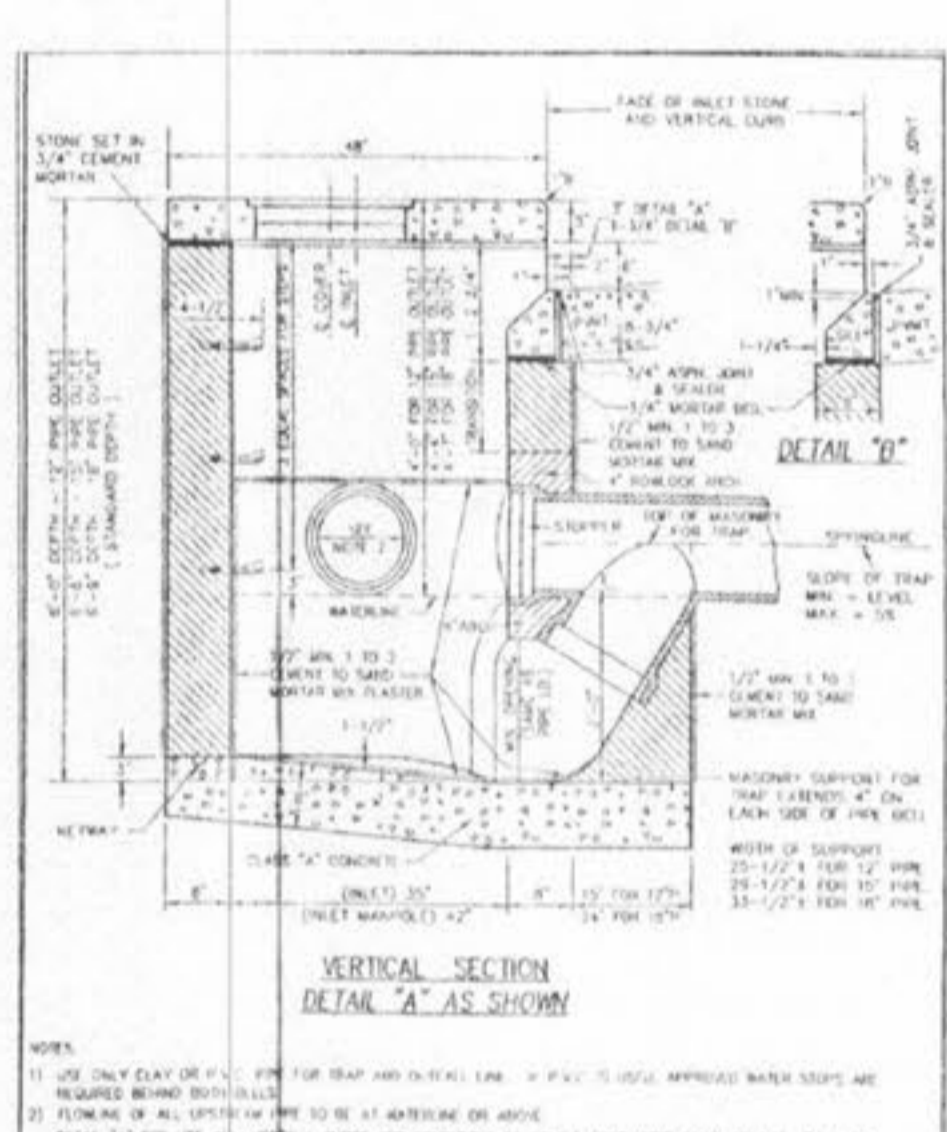

**TRAPPED STREET INLET BRICK CONSTRUCTION**  
 METROPOLITAN ST. LOUIS SEWER DISTRICT  
 Standard Details of Sewer Construction  
 SHEET 26

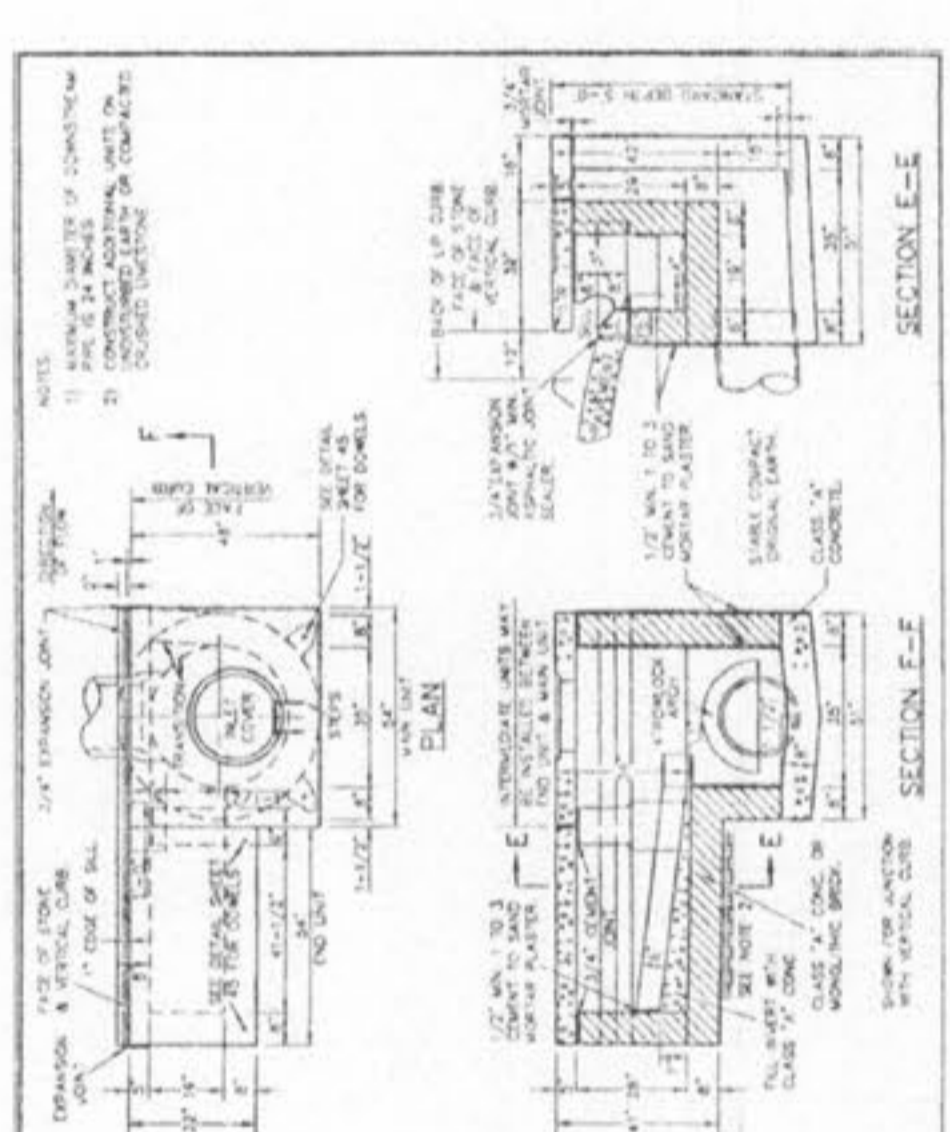

**MULTIPLE STREET INLET BRICK CONSTRUCTION**  
 METROPOLITAN ST. LOUIS SEWER DISTRICT  
 Standard Details of Sewer Construction  
 SHEET 27

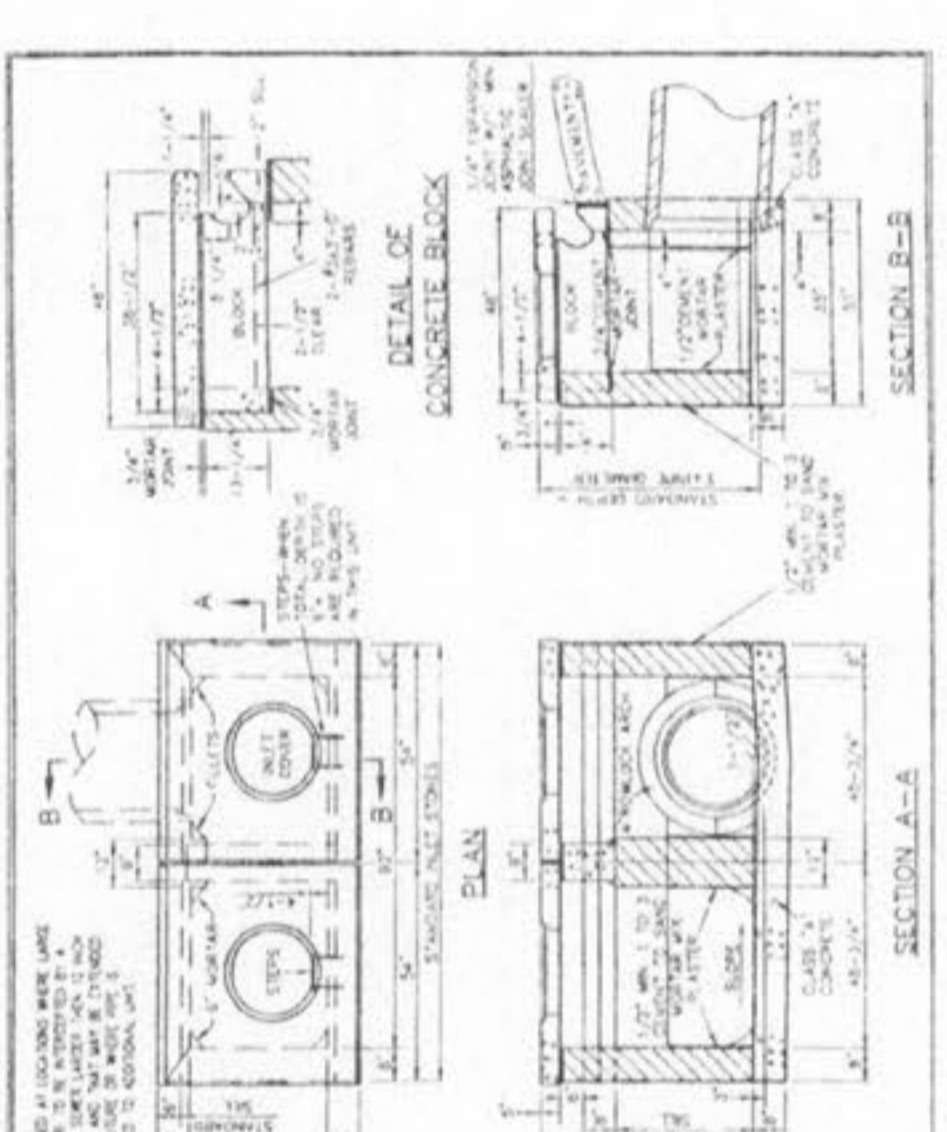

**DOUBLE UNTRAPPED STREET INLET BRICK CONSTRUCTION**  
 METROPOLITAN ST. LOUIS SEWER DISTRICT  
 Standard Details of Sewer Construction  
 SHEET 28

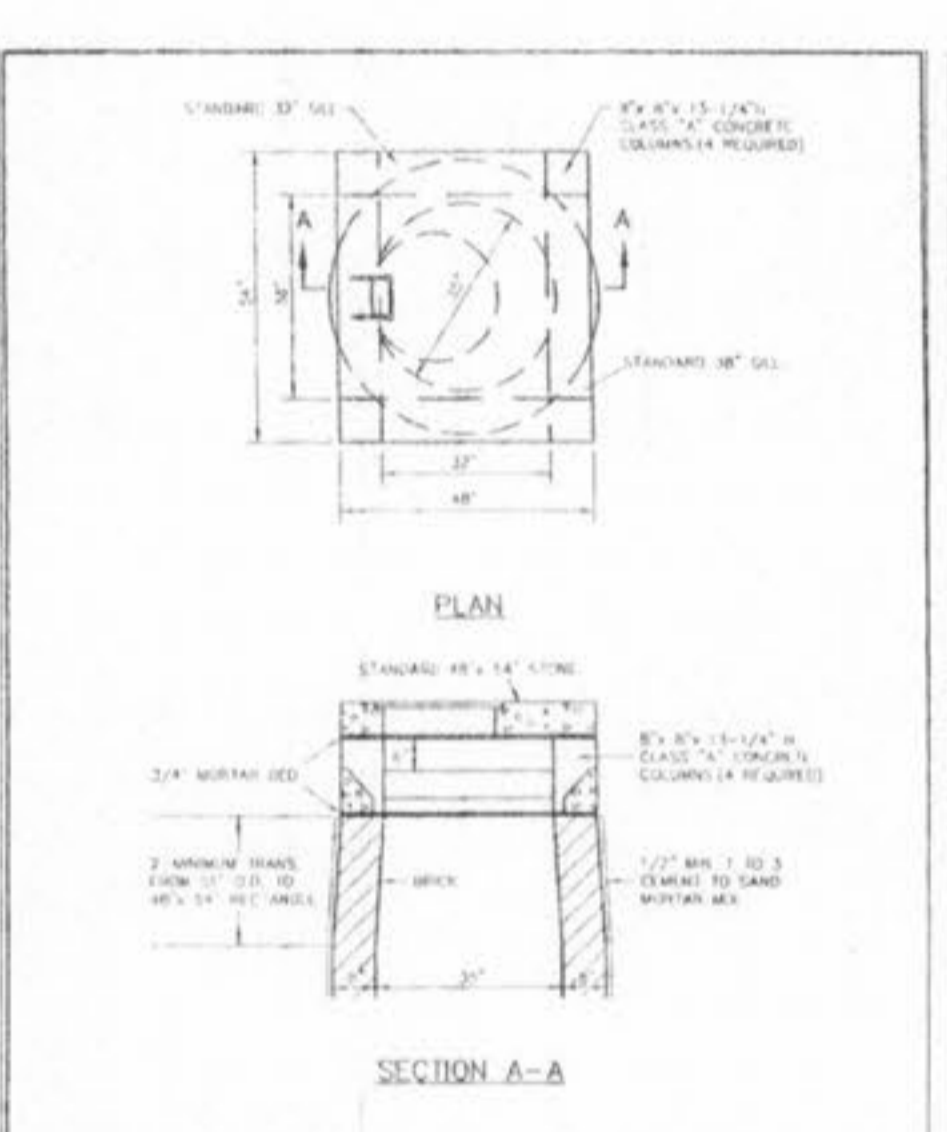

**AREA INLET OPEN 4 SIDES BRICK CONSTRUCTION**  
 METROPOLITAN ST. LOUIS SEWER DISTRICT  
 Standard Details of Sewer Construction  
 SHEET 29

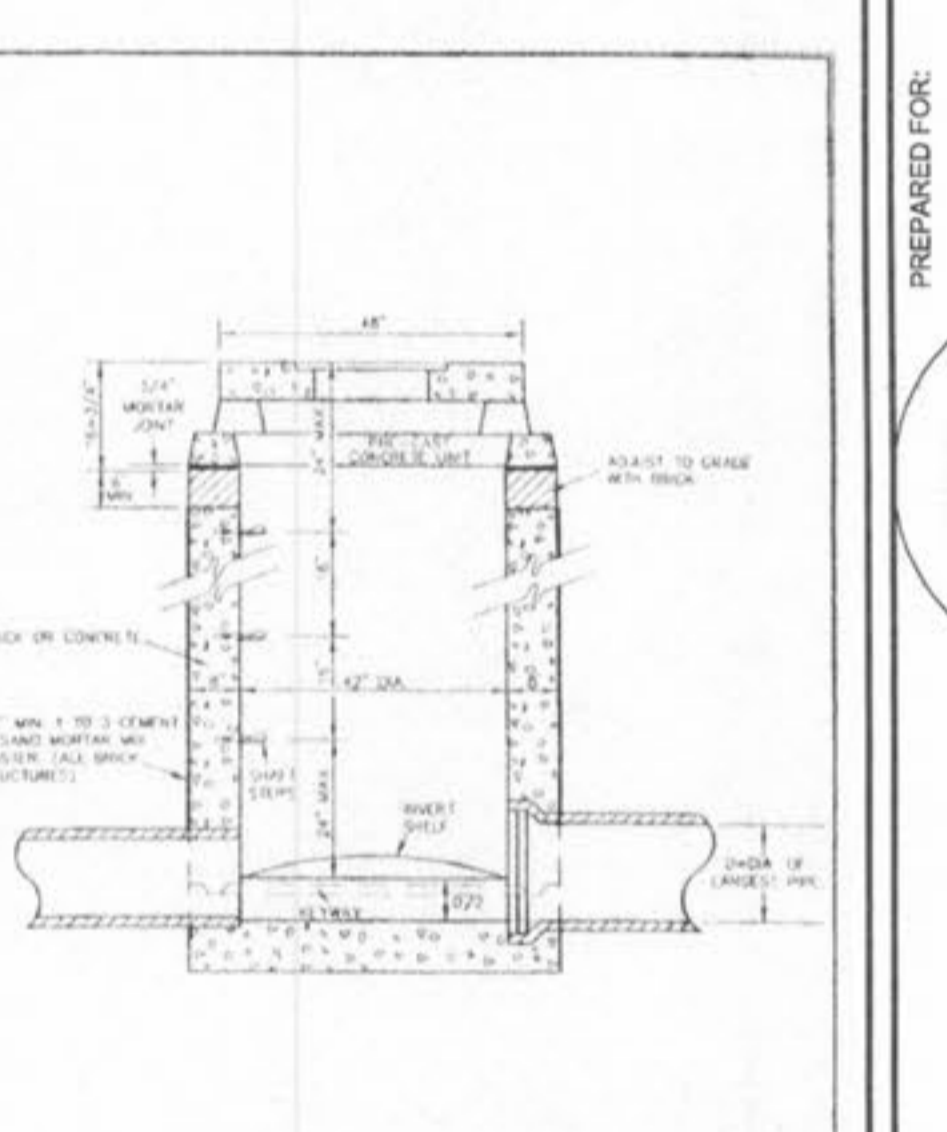

**AREA INLET MANHOLE (12" THRU 24")**  
 METROPOLITAN ST. LOUIS SEWER DISTRICT  
 Standard Details of Sewer Construction  
 SHEET 30

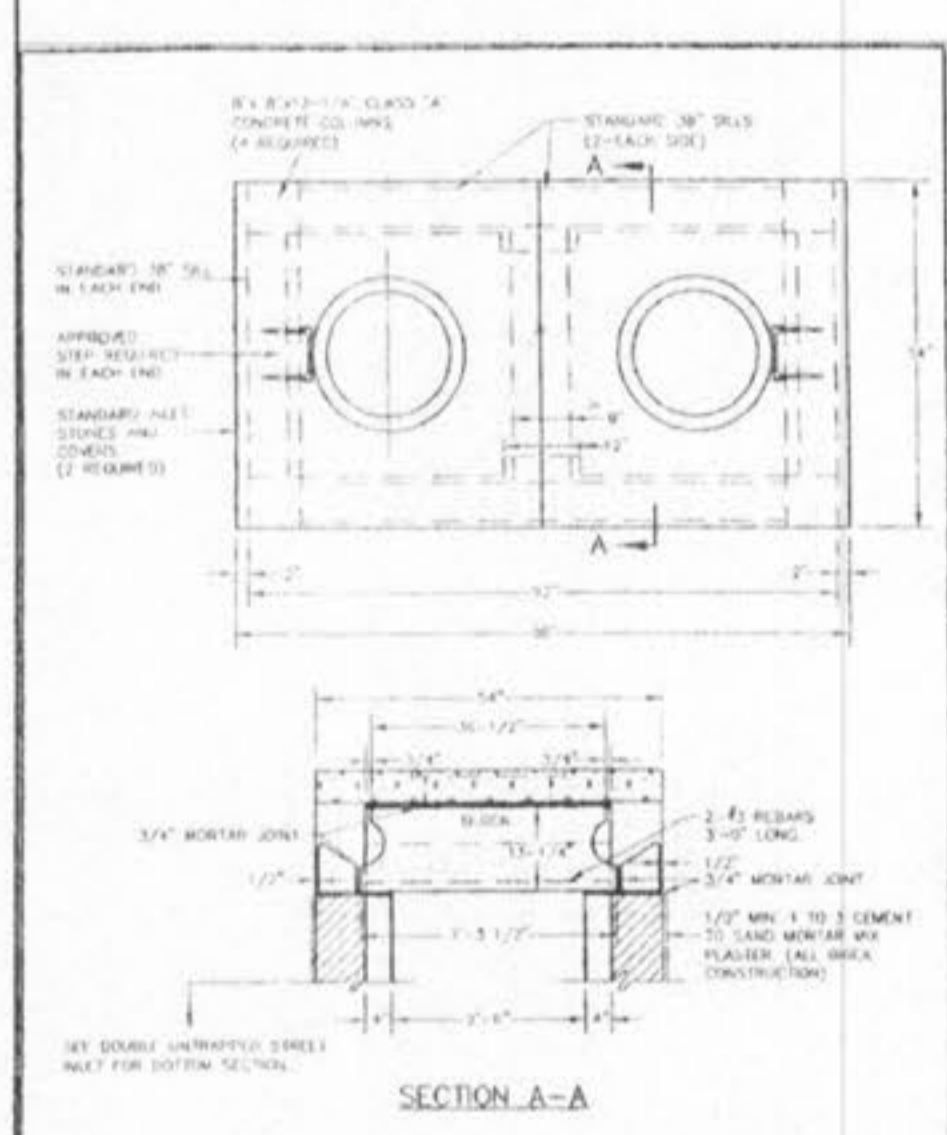

**DOUBLE AREA INLET OPEN 4 SIDES BRICK CONSTRUCTION**  
 METROPOLITAN ST. LOUIS SEWER DISTRICT  
 Standard Details of Sewer Construction  
 SHEET 31

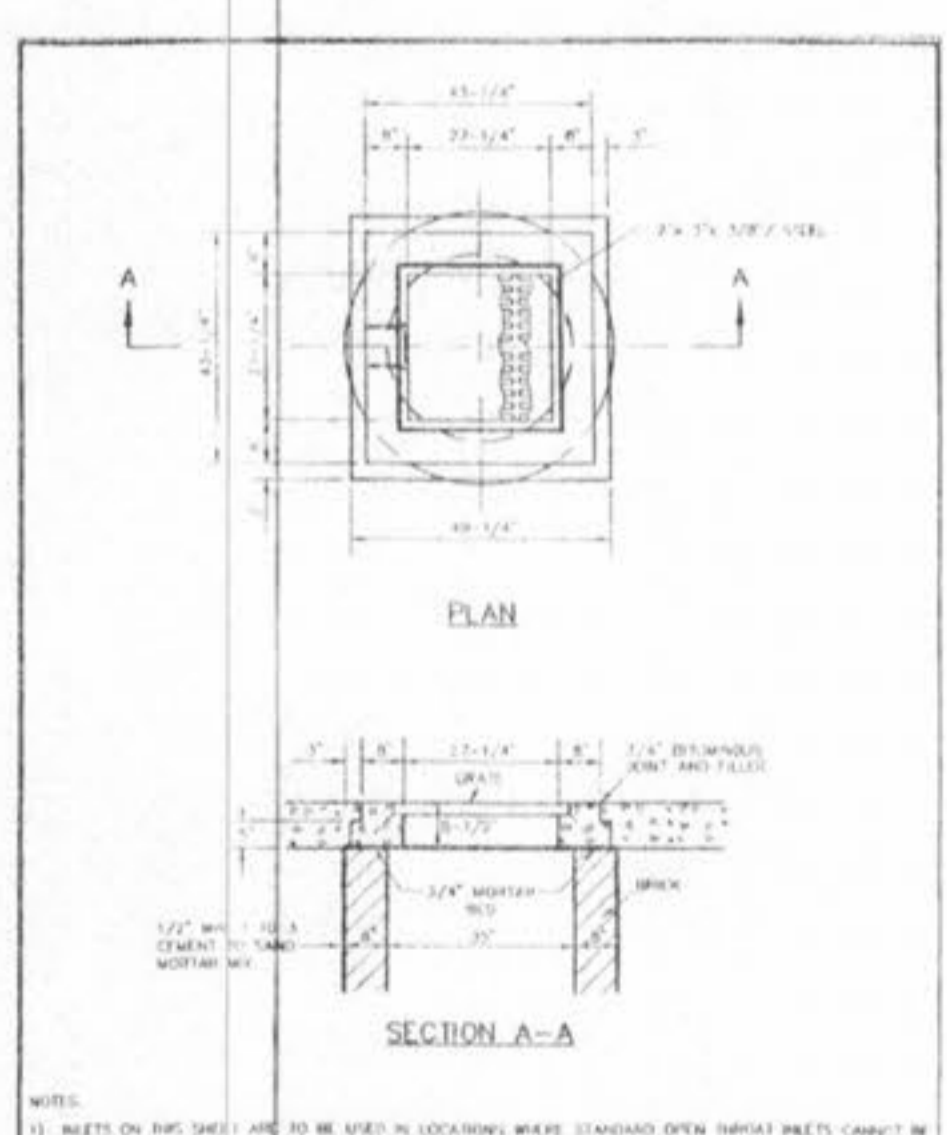

**2 GRATE INLET BRICK CONSTRUCTION**  
 METROPOLITAN ST. LOUIS SEWER DISTRICT  
 Standard Details of Sewer Construction  
 SHEET 32

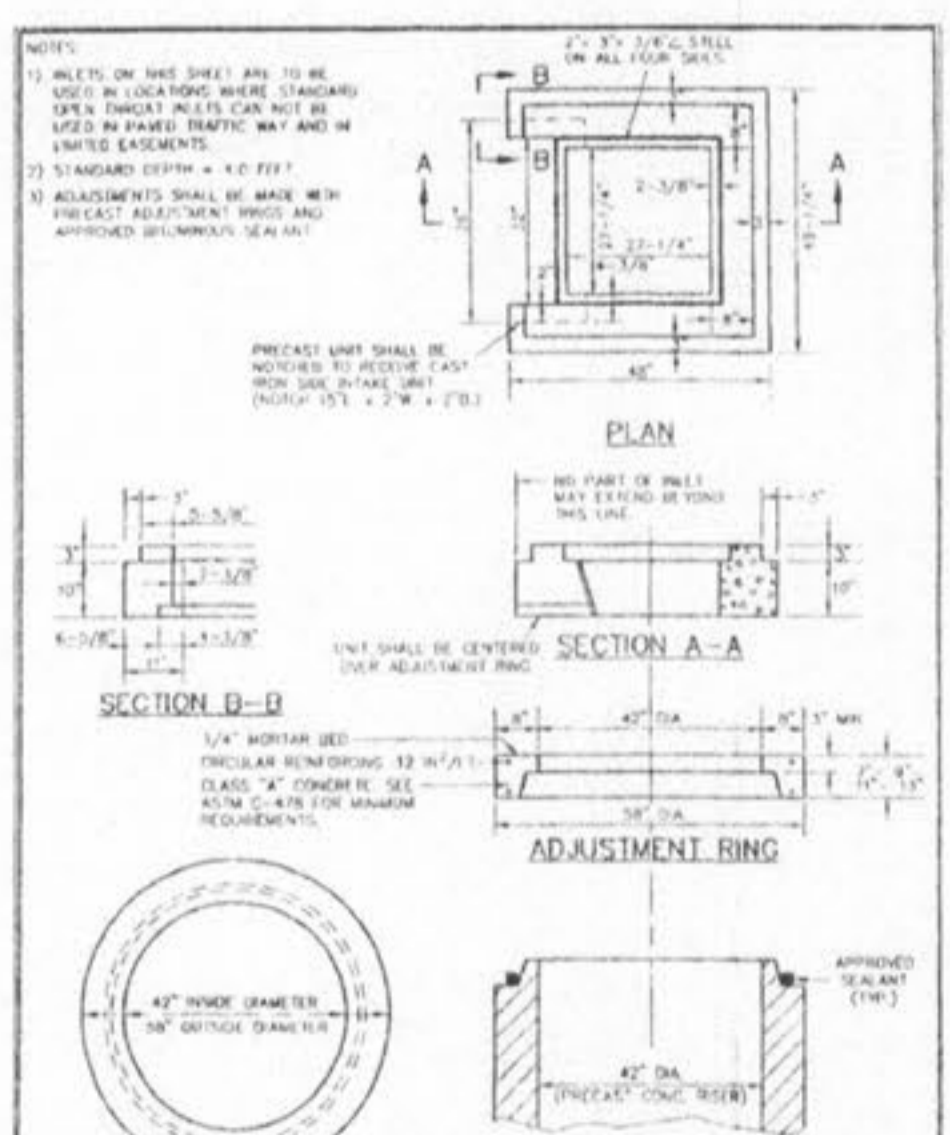

**GRATE SEAT FOR 2 GRATE WITH SIDE INTAKE**  
 METROPOLITAN ST. LOUIS SEWER DISTRICT  
 Standard Details of Sewer Construction  
 SHEET 33

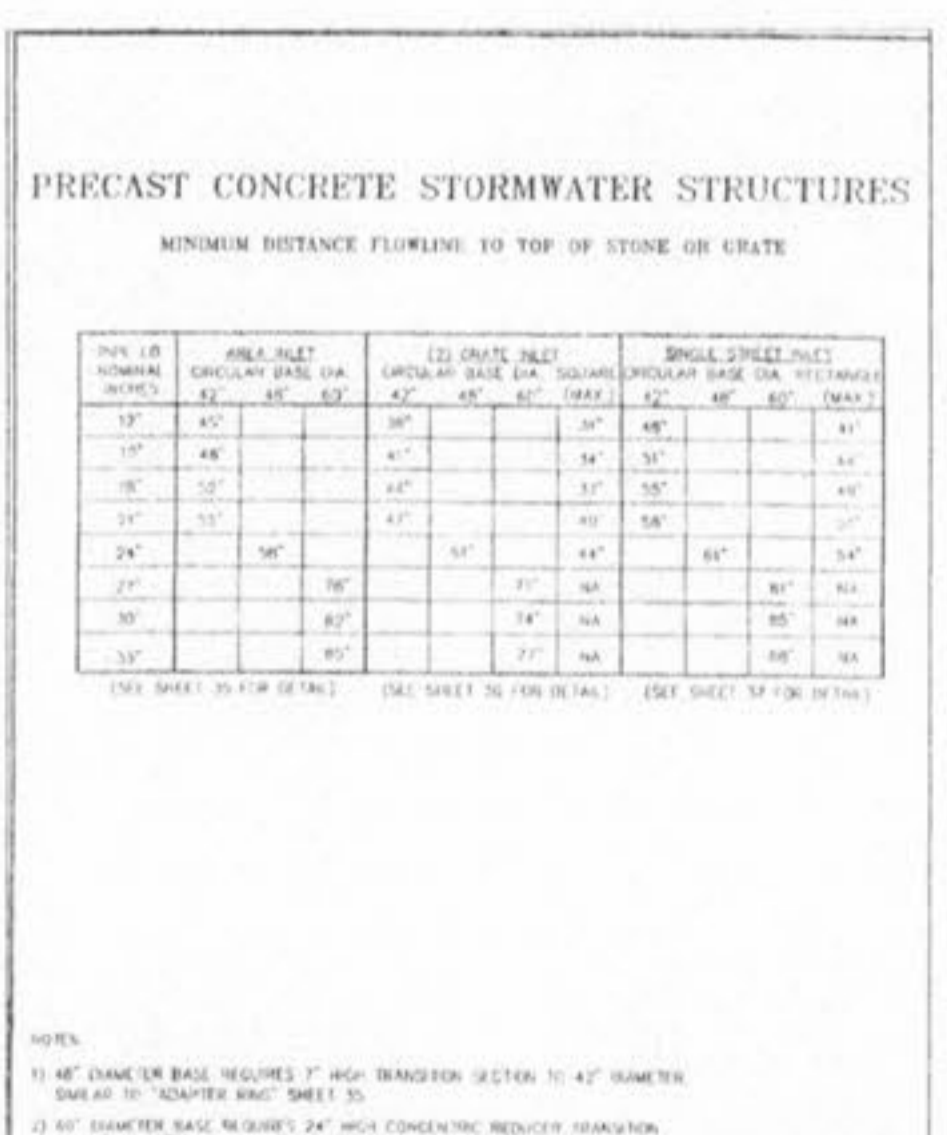

**PRECAST CONCRETE STORMWATER STRUCTURES**  
 METROPOLITAN ST. LOUIS SEWER DISTRICT  
 Standard Details of Sewer Construction  
 SHEET 34

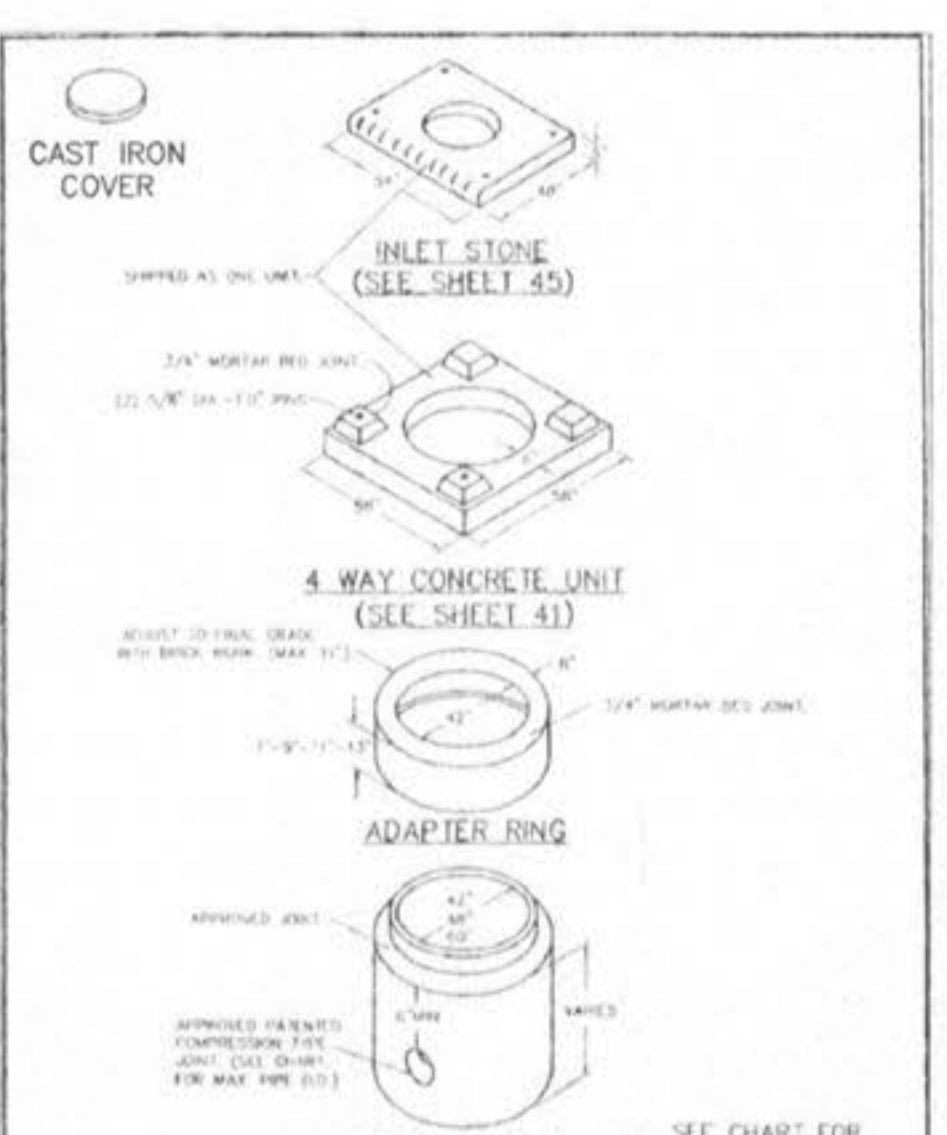

**CAST IRON COVER**  
 METROPOLITAN ST. LOUIS SEWER DISTRICT  
 Standard Details of Sewer Construction  
 SHEET 35

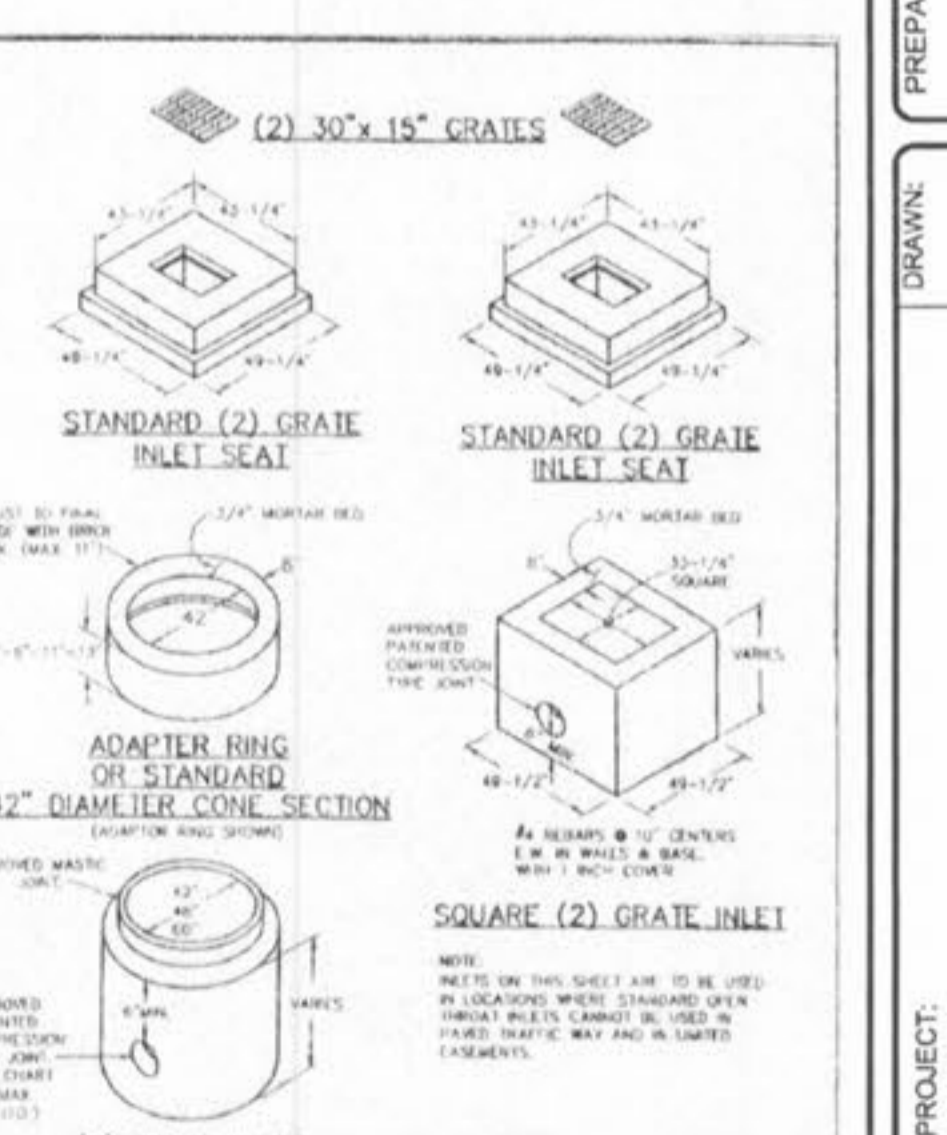

**2 GRATE INLETS PRECAST CONCRETE**  
 METROPOLITAN ST. LOUIS SEWER DISTRICT  
 Standard Details of Sewer Construction  
 SHEET 36

ISSUE REMARKS/DATE  
 1 08/15/03 - P/added

PREPARED FOR:  
**WHISPERING L.L.C.**  
 5091 NEW BAUMGARTNER ROAD  
 ST. LOUIS, MISSOURI  
 (314) 487-8717

THE **STERLING** CO.  
 ENGINEERS & SURVEYORS  
 5055 NEW BAUMGARTNER ROAD  
 ST. LOUIS, MISSOURI 63112  
 (314) 487-2440 FAX 487-2424  
 E-Mail: Sterling@con-est.net

DRAWN: DESIGNED: CHECKED:  
 PROJECT: SHEET TITLE: CONSTRUCTION DETAILS

NO. 03 02 021  
 M.S.D. SHEET  
 P# CD4  
 DIGITAL FILE LOCATION: SEWER-STERLING-2  
 DATE: 08/15/03