

INSIDE FOULWATER DROP MANHOLE METROPOLITAN ST. LOUIS SEWER DISTRICT Standard Details of Sewer Construction

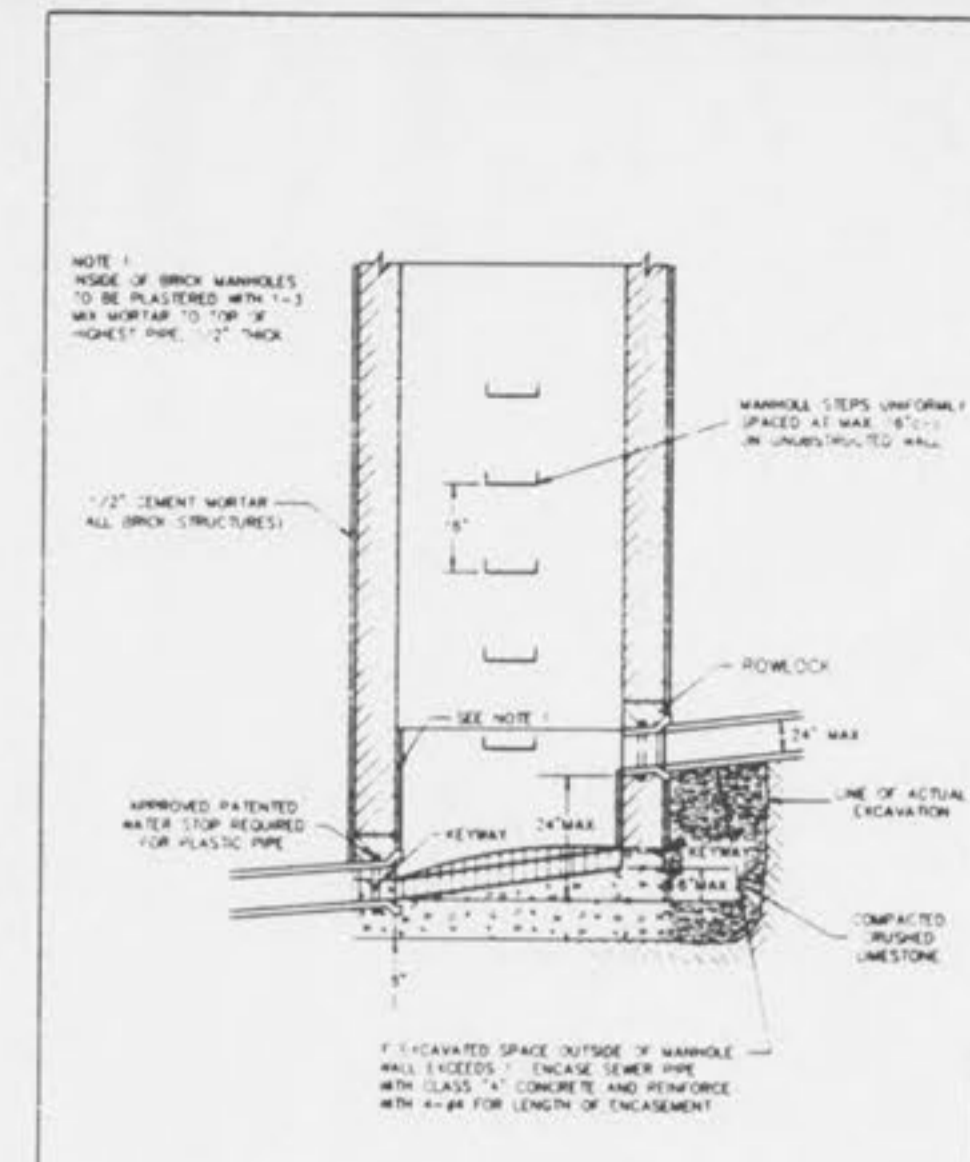

INSIDE FOULWATER DROP MANHOLE (FOR FREE-FALL) METROPOLITAN ST. LOUIS SEWER DISTRICT Standard Details of Sewer Construction

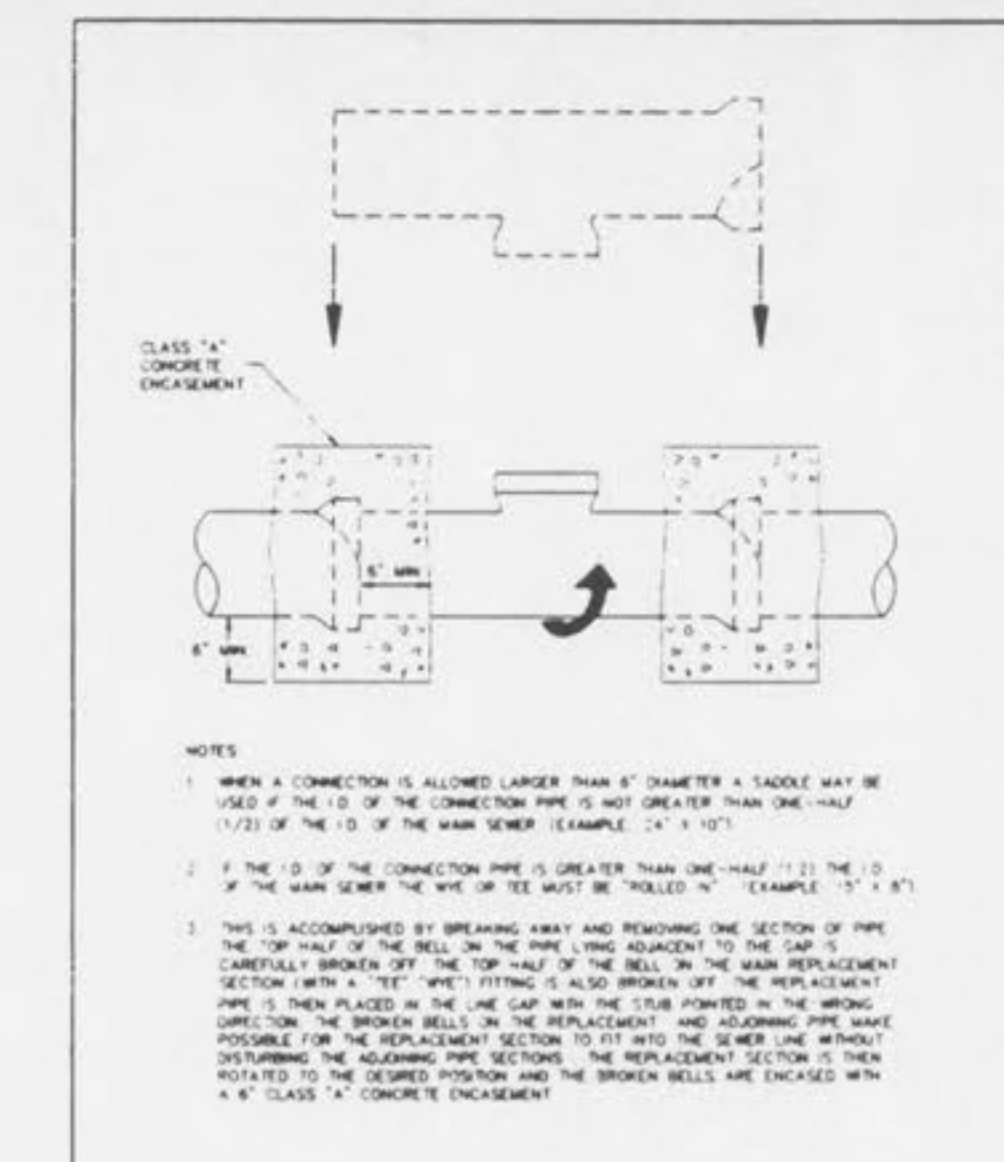

'ROLL-IN' (FOR EXISTING CLAY OR CONCRETE PIPE) METROPOLITAN ST. LOUIS SEWER DISTRICT Standard Details of Sewer Construction

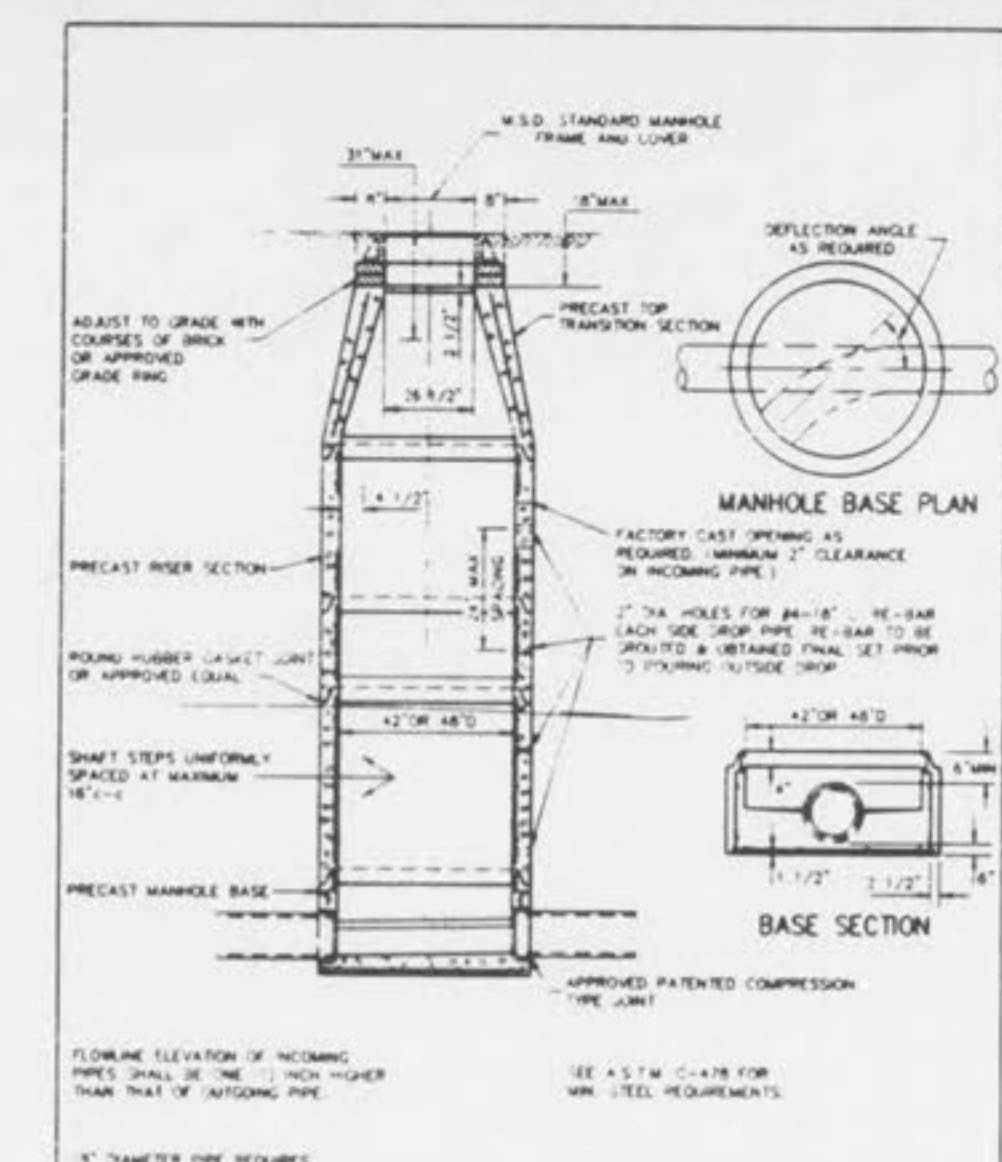

PRE-CAST CONCRETE MANHOLE FOR SEWERS 8" THROUGH 18" METROPOLITAN ST. LOUIS SEWER DISTRICT Standard Details of Sewer Construction

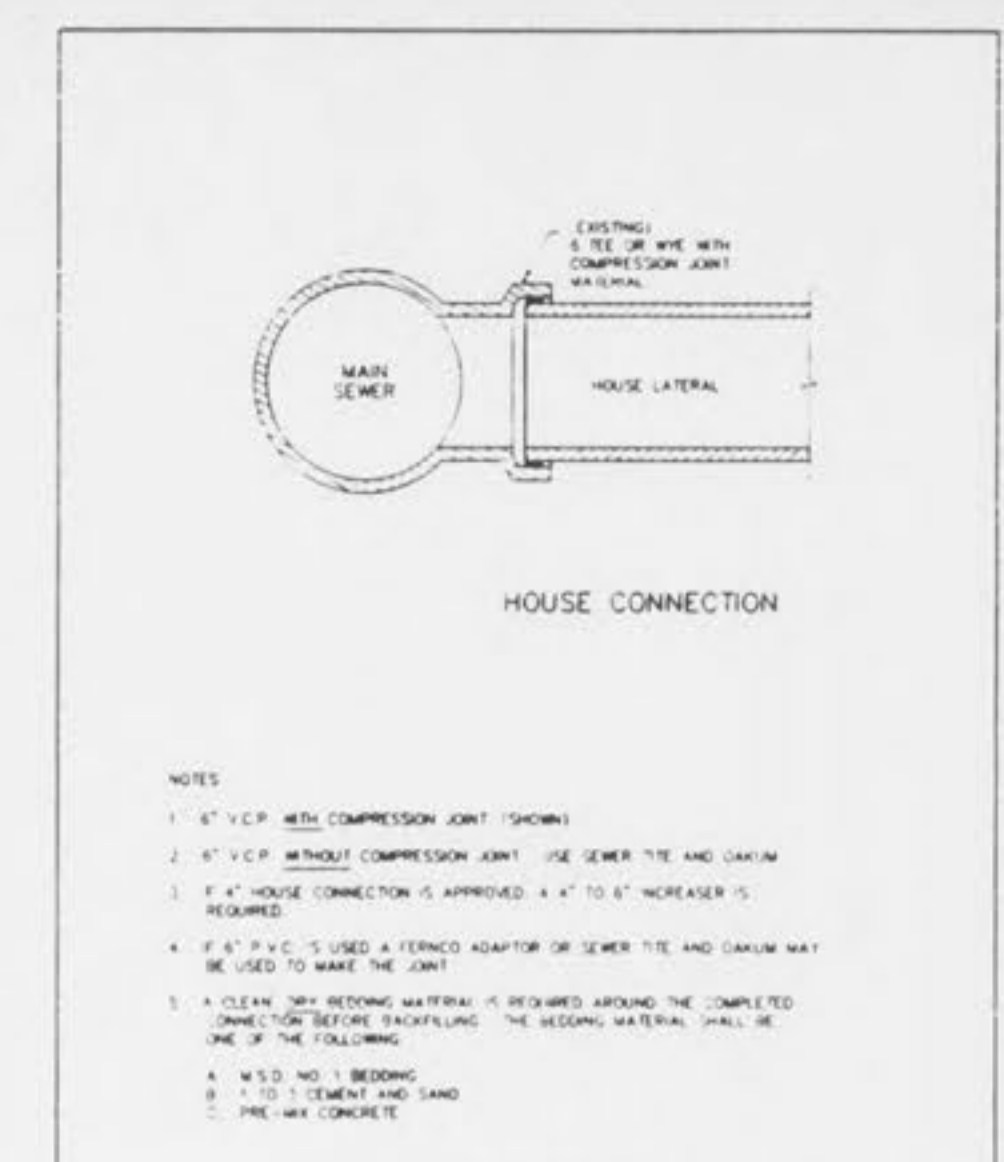

HOUSE CONNECTION TO EXISTING TEE OR WYE METROPOLITAN ST. LOUIS SEWER DISTRICT Standard Details of Sewer Construction

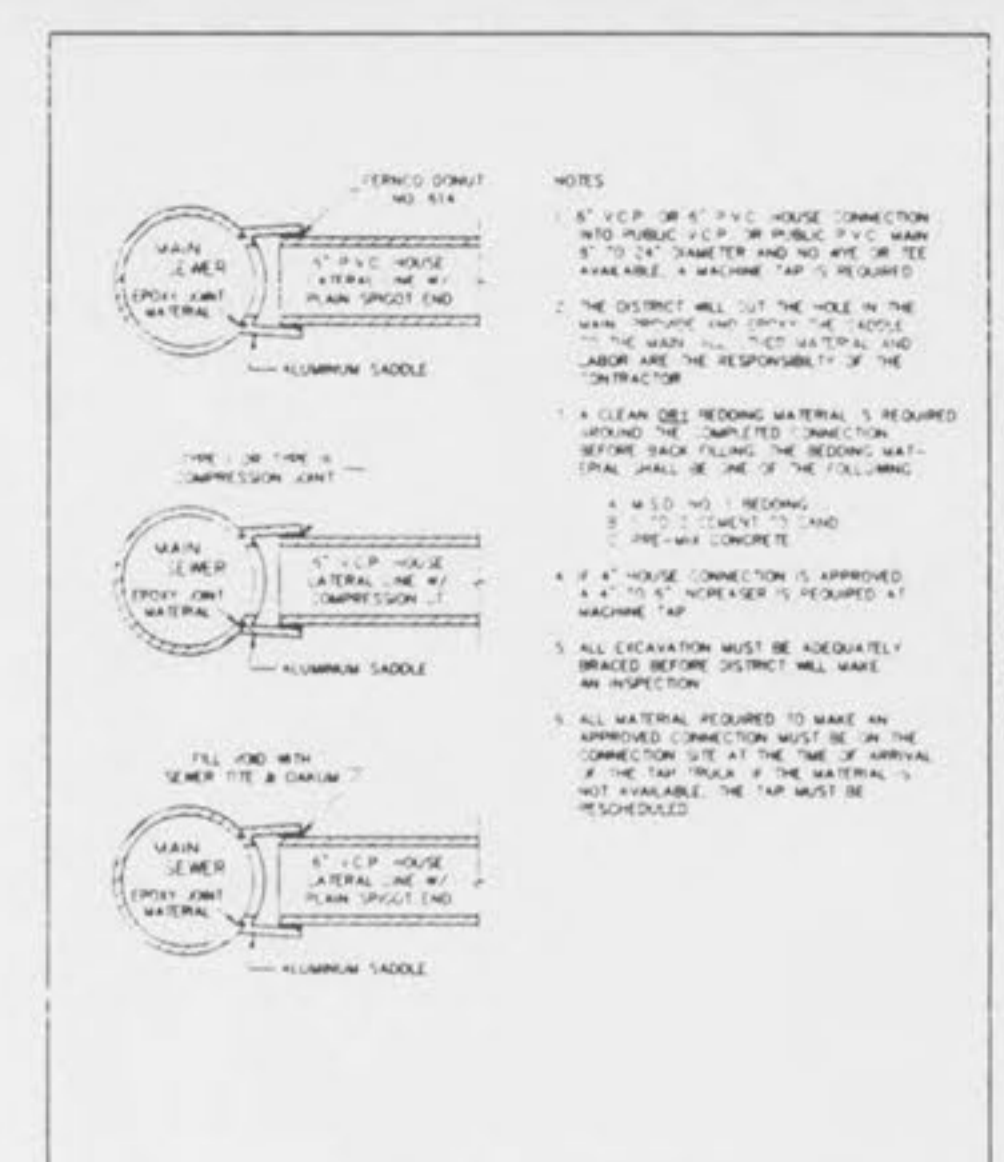

MACHINE TAP METROPOLITAN ST. LOUIS SEWER DISTRICT Standard Details of Sewer Construction

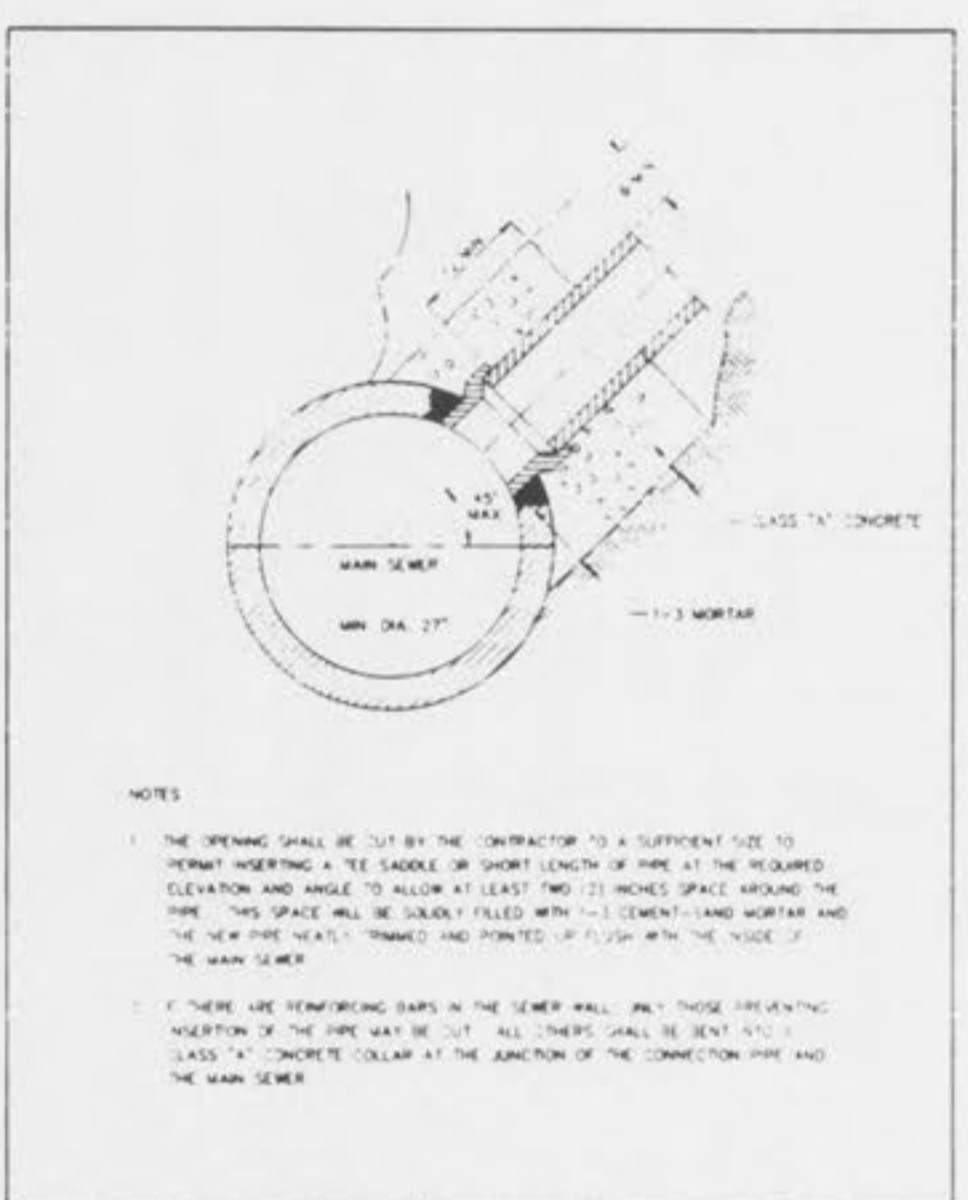

HOUSE CONNECTIONS ALLOWED BY TEE SADDLE METROPOLITAN ST. LOUIS SEWER DISTRICT Standard Details of Sewer Construction

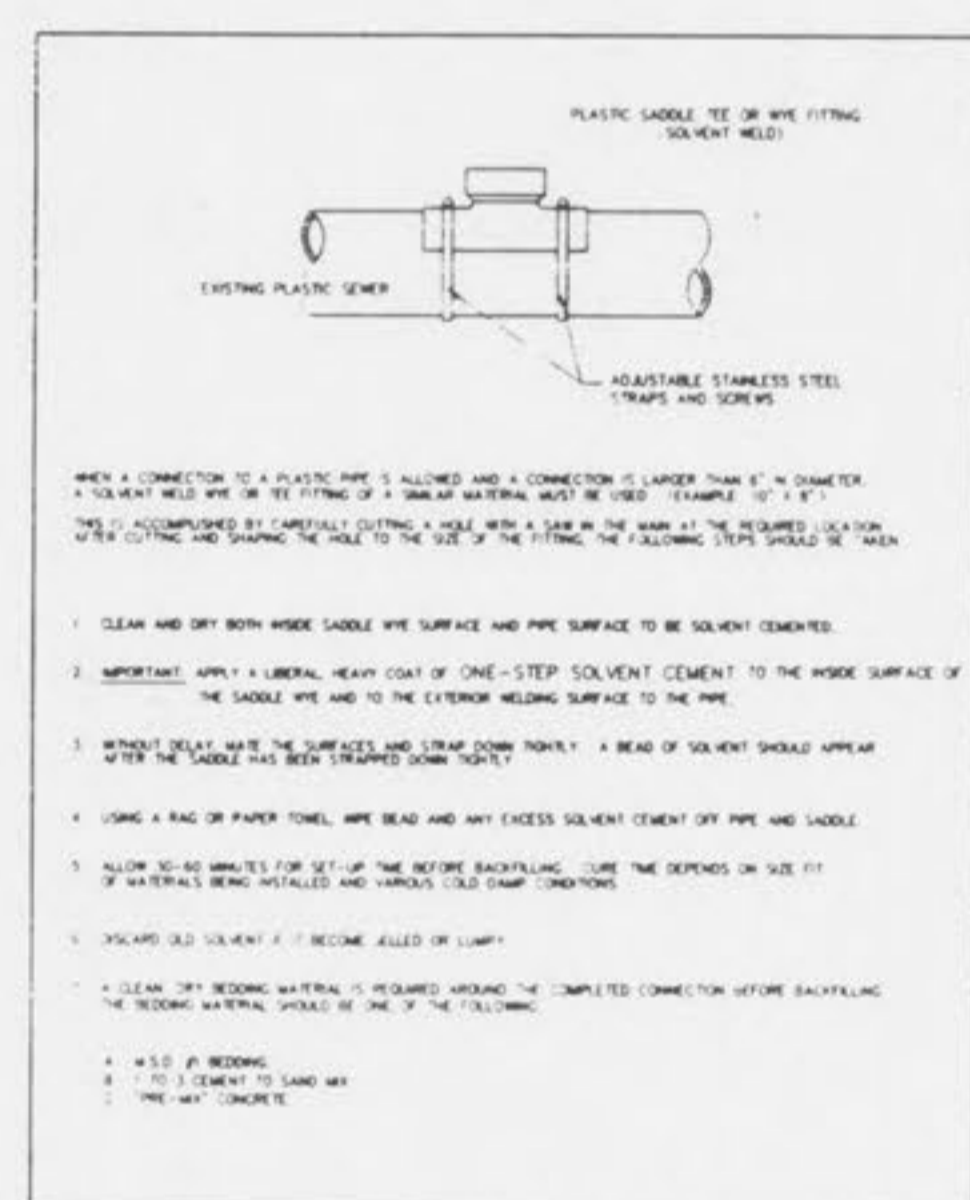

8" (& LARGER) CONNECTION TO PLASTIC MAIN METROPOLITAN ST. LOUIS SEWER DISTRICT Standard Details of Sewer Construction

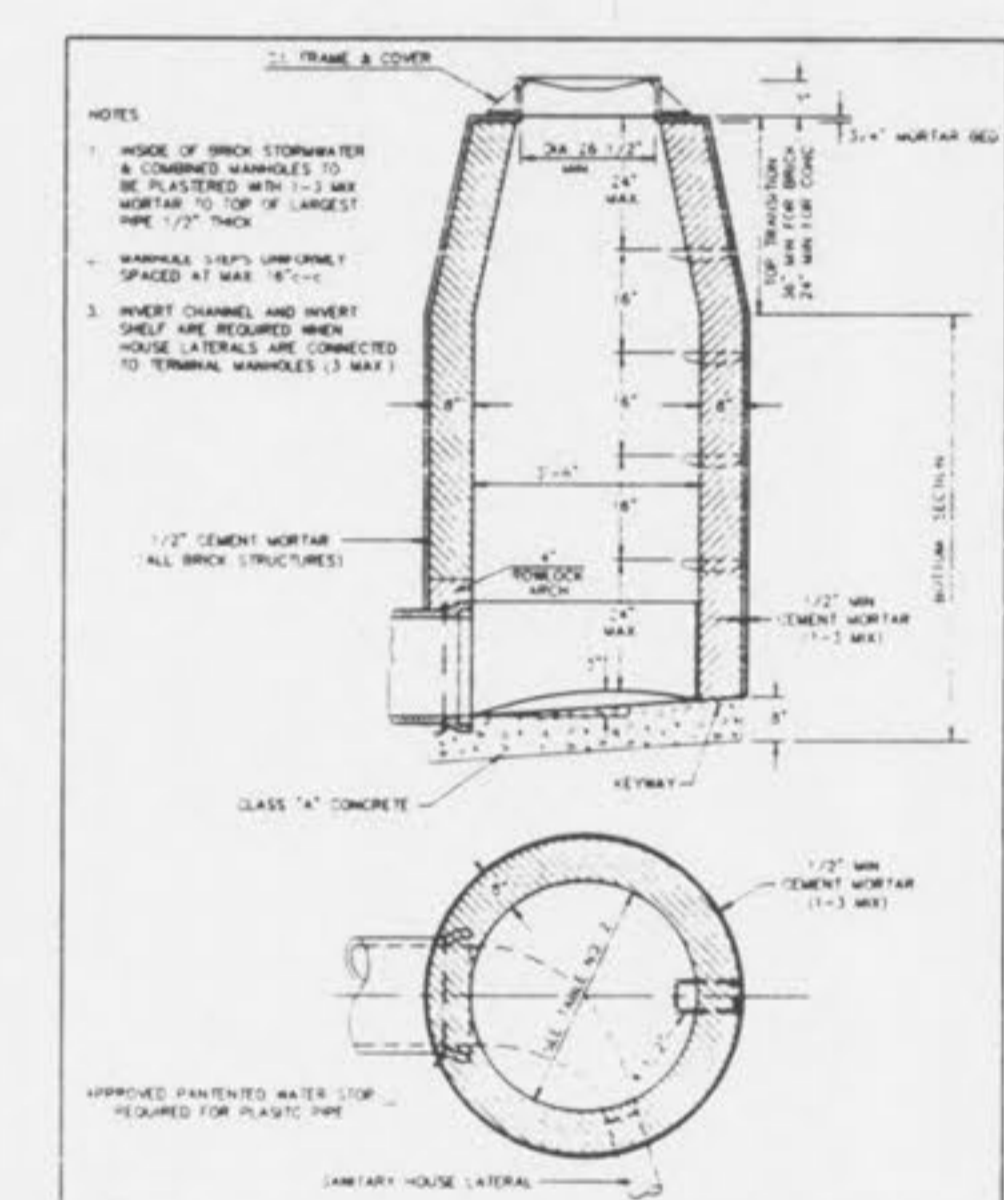

TERMINAL MANHOLE METROPOLITAN ST. LOUIS SEWER DISTRICT Standard Details of Sewer Construction

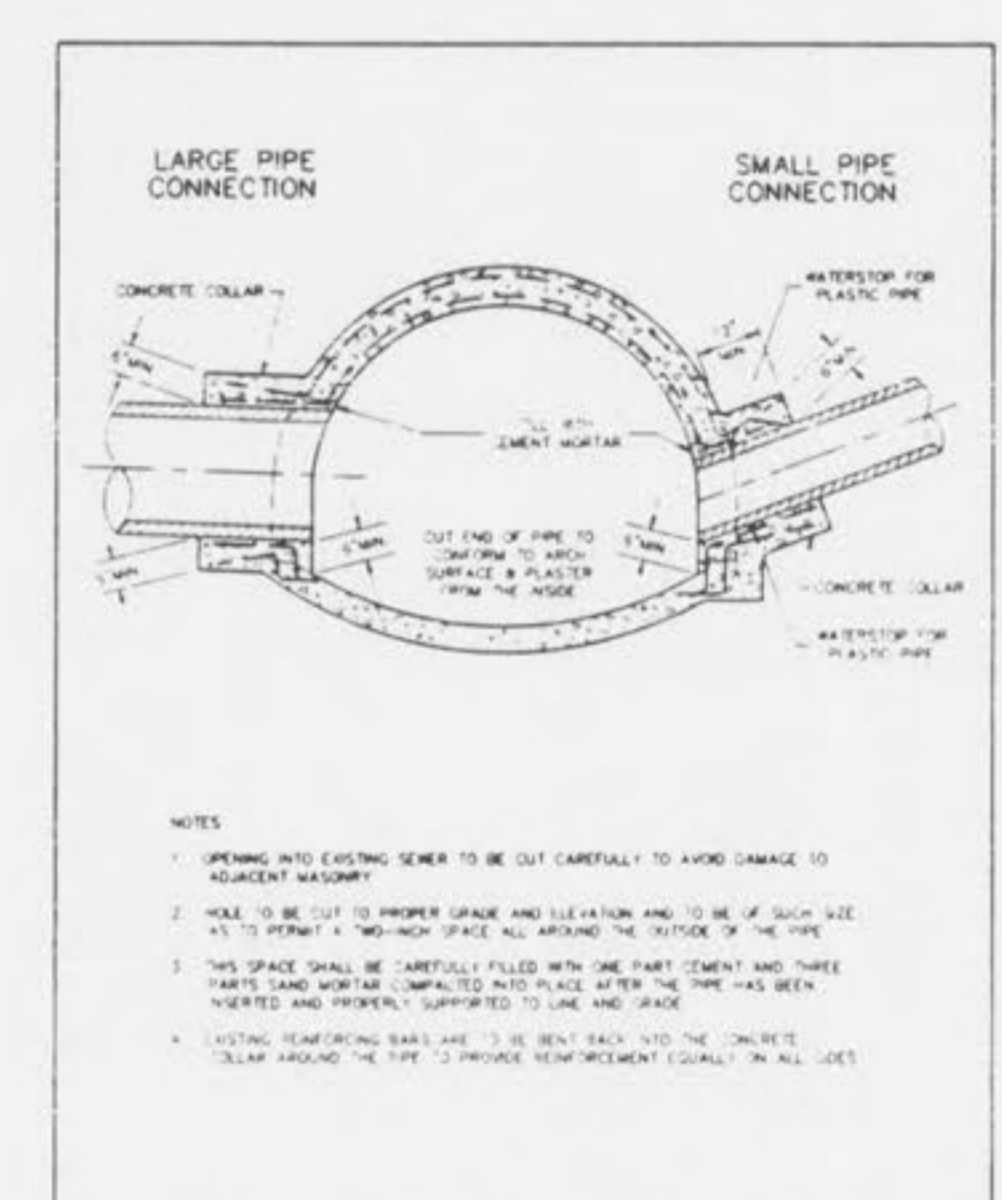

CONNECTIONS TO LARGE SEWERS METROPOLITAN ST. LOUIS SEWER DISTRICT Standard Details of Sewer Construction

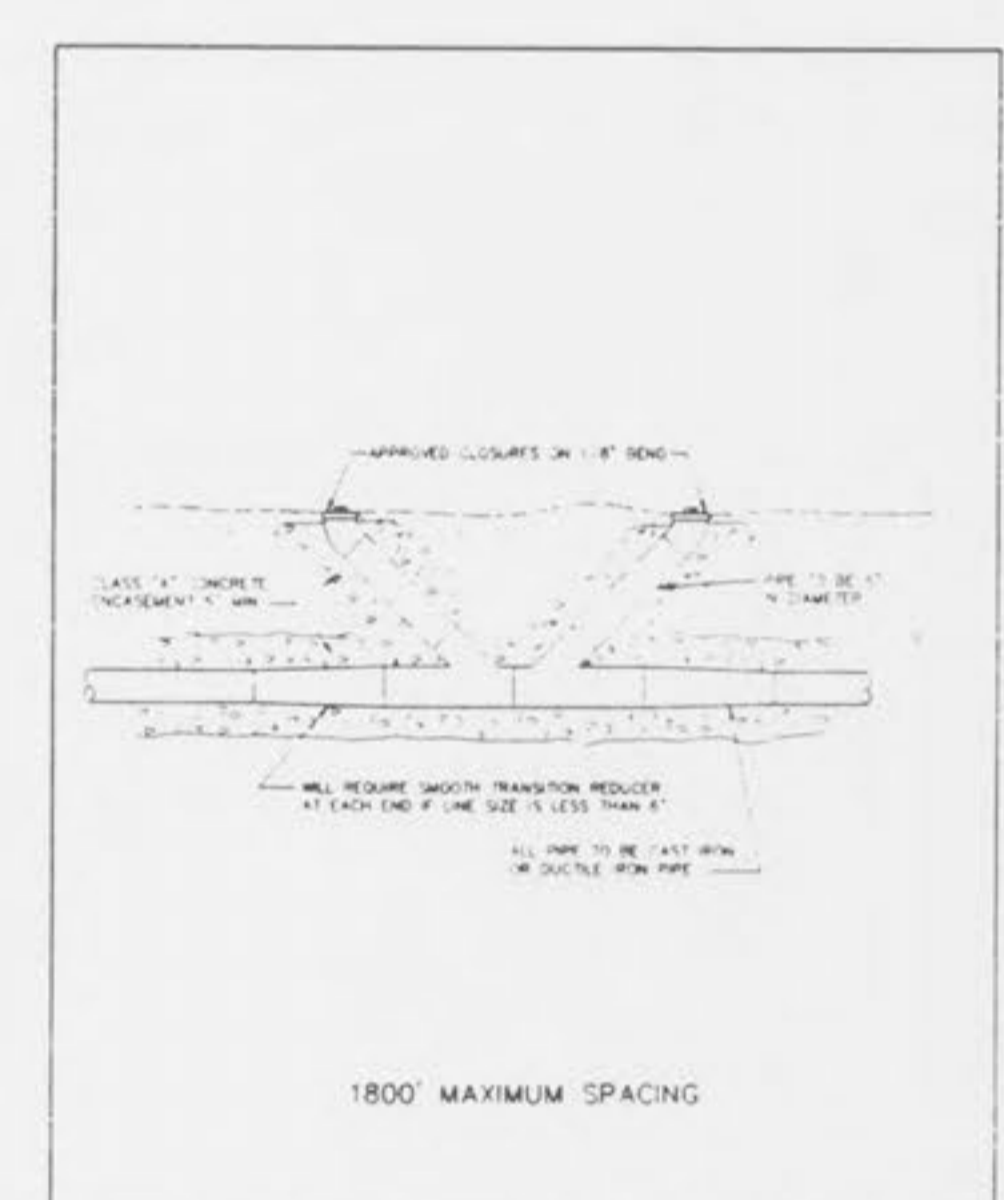

FORCE MAIN CLEANOUT (6" DIA & SMALLER) METROPOLITAN ST. LOUIS SEWER DISTRICT Standard Details of Sewer Construction

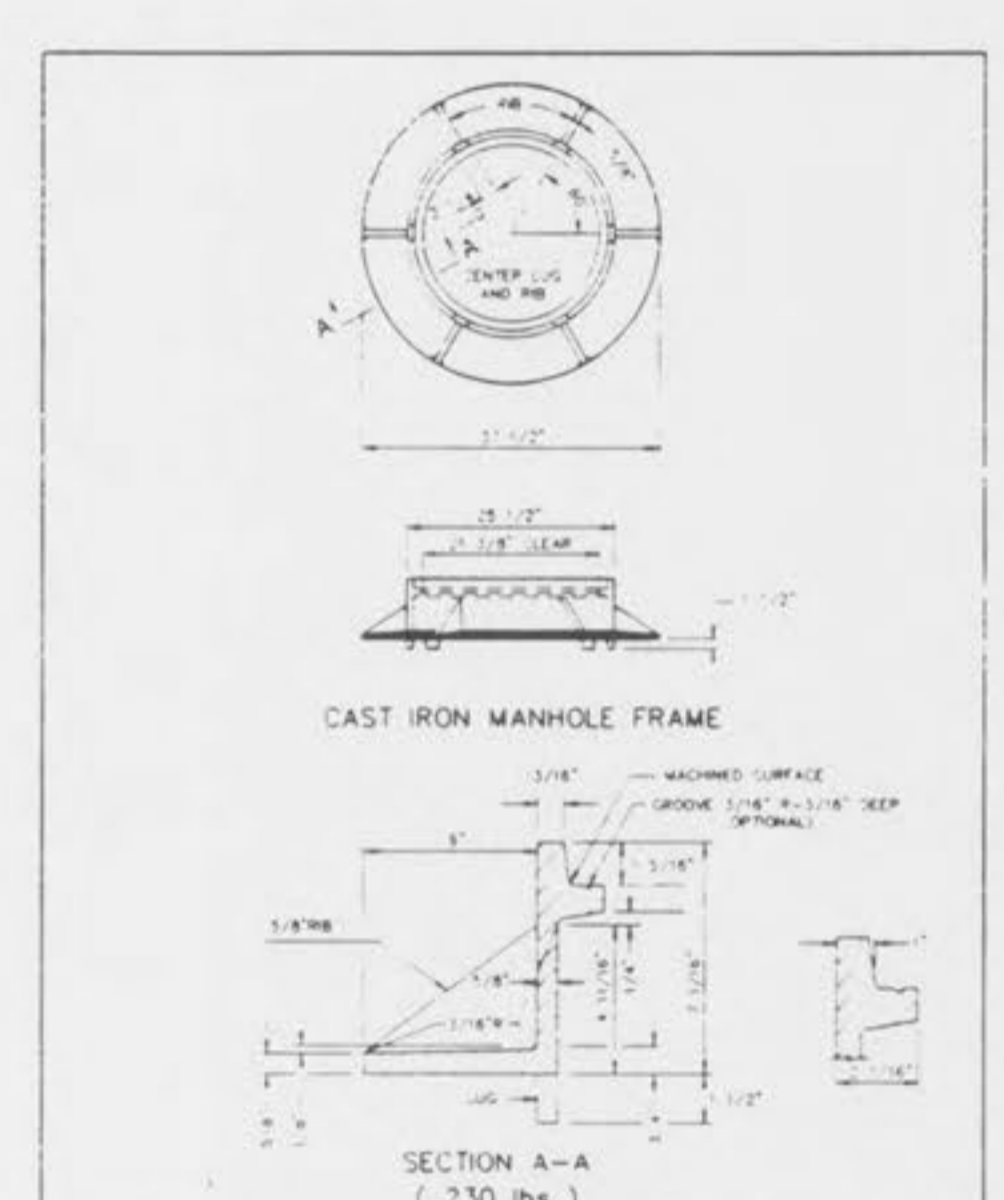

CAST IRON MANHOLE FRAME METROPOLITAN ST. LOUIS SEWER DISTRICT Standard Details of Sewer Construction

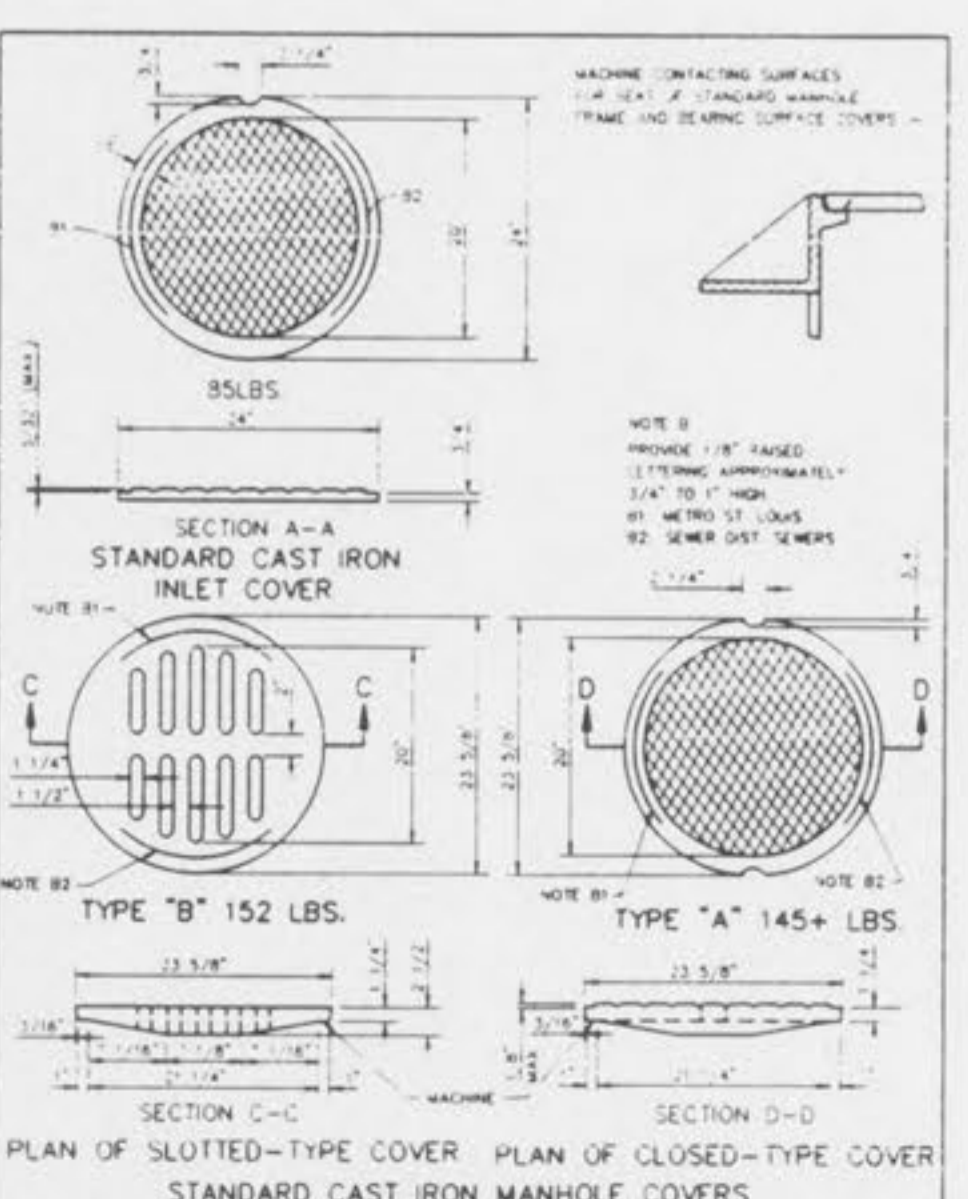

CAST IRON COVERS MANHOLES AND INLETS METROPOLITAN ST. LOUIS SEWER DISTRICT Standard Details of Sewer Construction

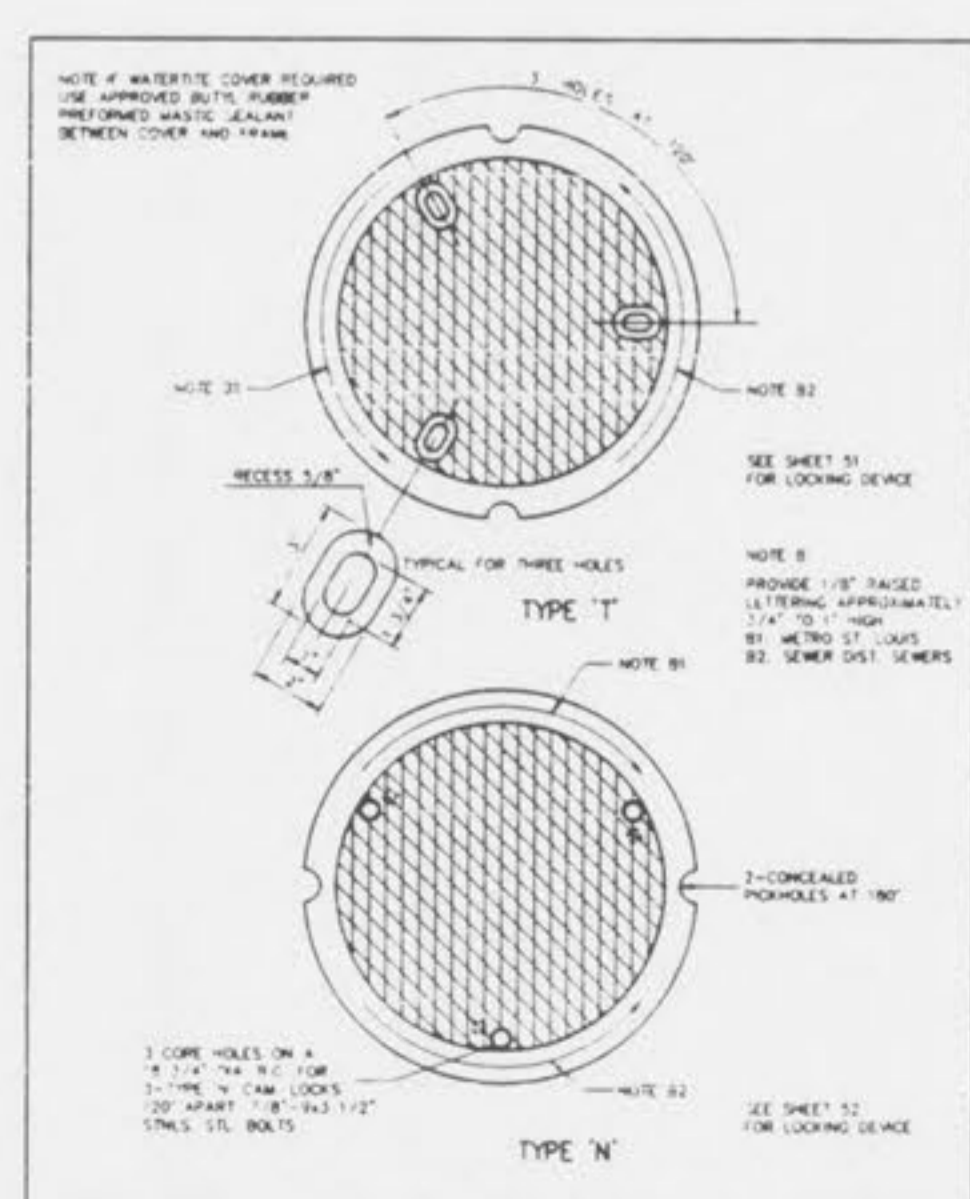

CAST IRON MANHOLE COVERS (LOCK TYPE) METROPOLITAN ST. LOUIS SEWER DISTRICT Standard Details of Sewer Construction

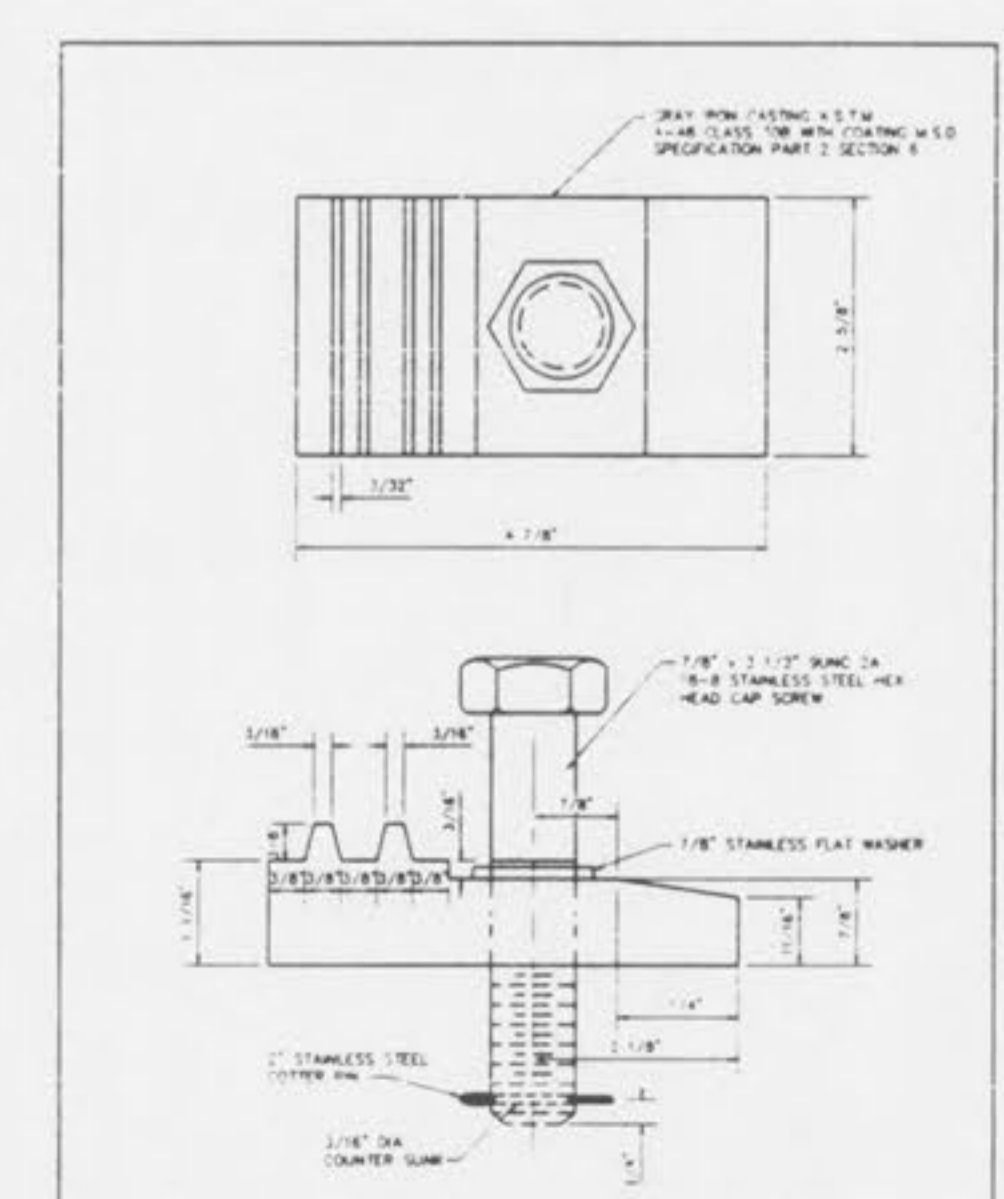

LOCKING DEVICE FOR TYPE 'T' LOCK TYPE MANHOLE COVER METROPOLITAN ST. LOUIS SEWER DISTRICT Standard Details of Sewer Construction

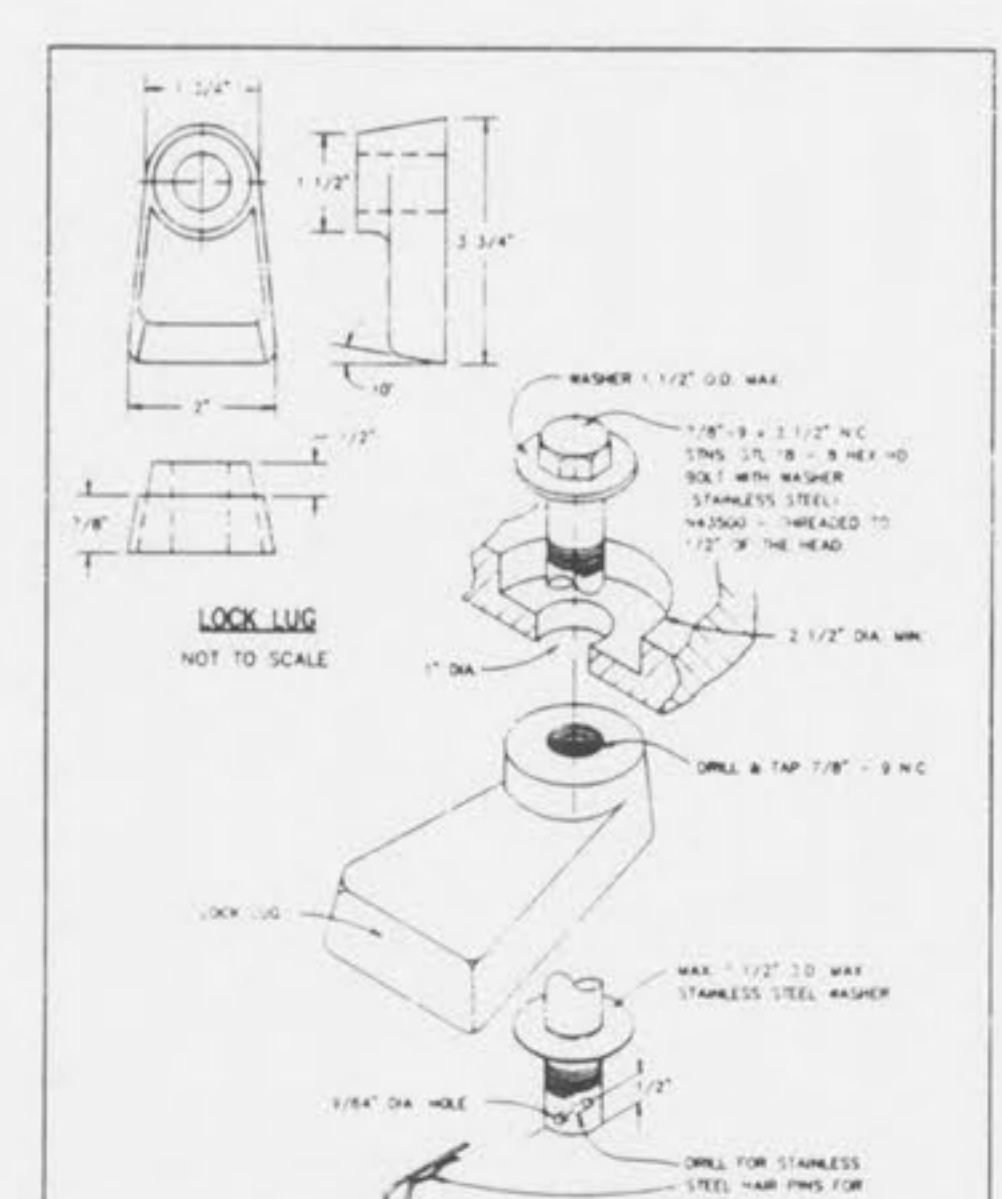

LOCKING DEVICE FOR TYPE 'N' LOCK TYPE MANHOLE COVER METROPOLITAN ST. LOUIS SEWER DISTRICT Standard Details of Sewer Construction

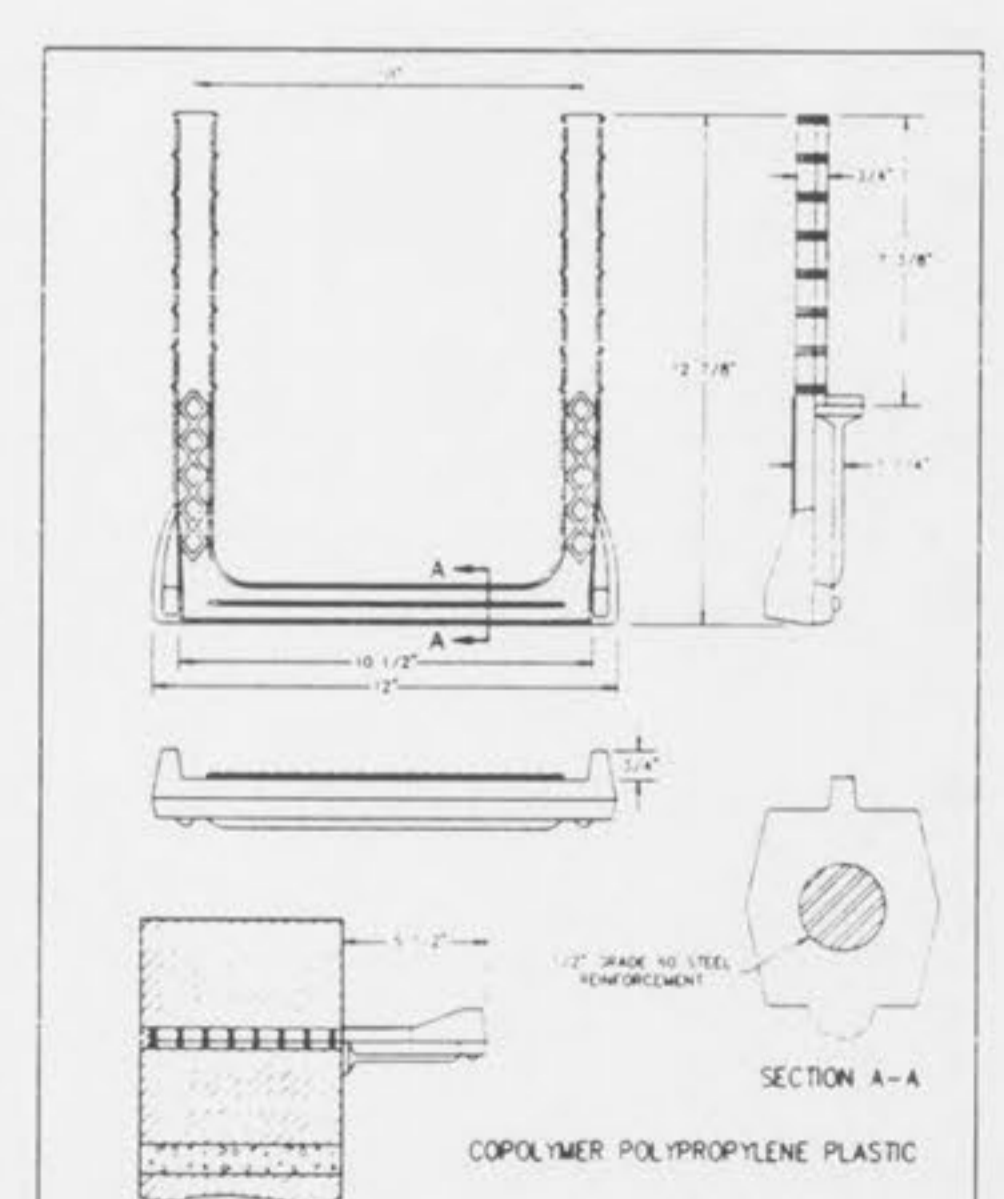

PSI-B MANHOLE STEP INTO JOINT METROPOLITAN ST. LOUIS SEWER DISTRICT Standard Details of Sewer Construction

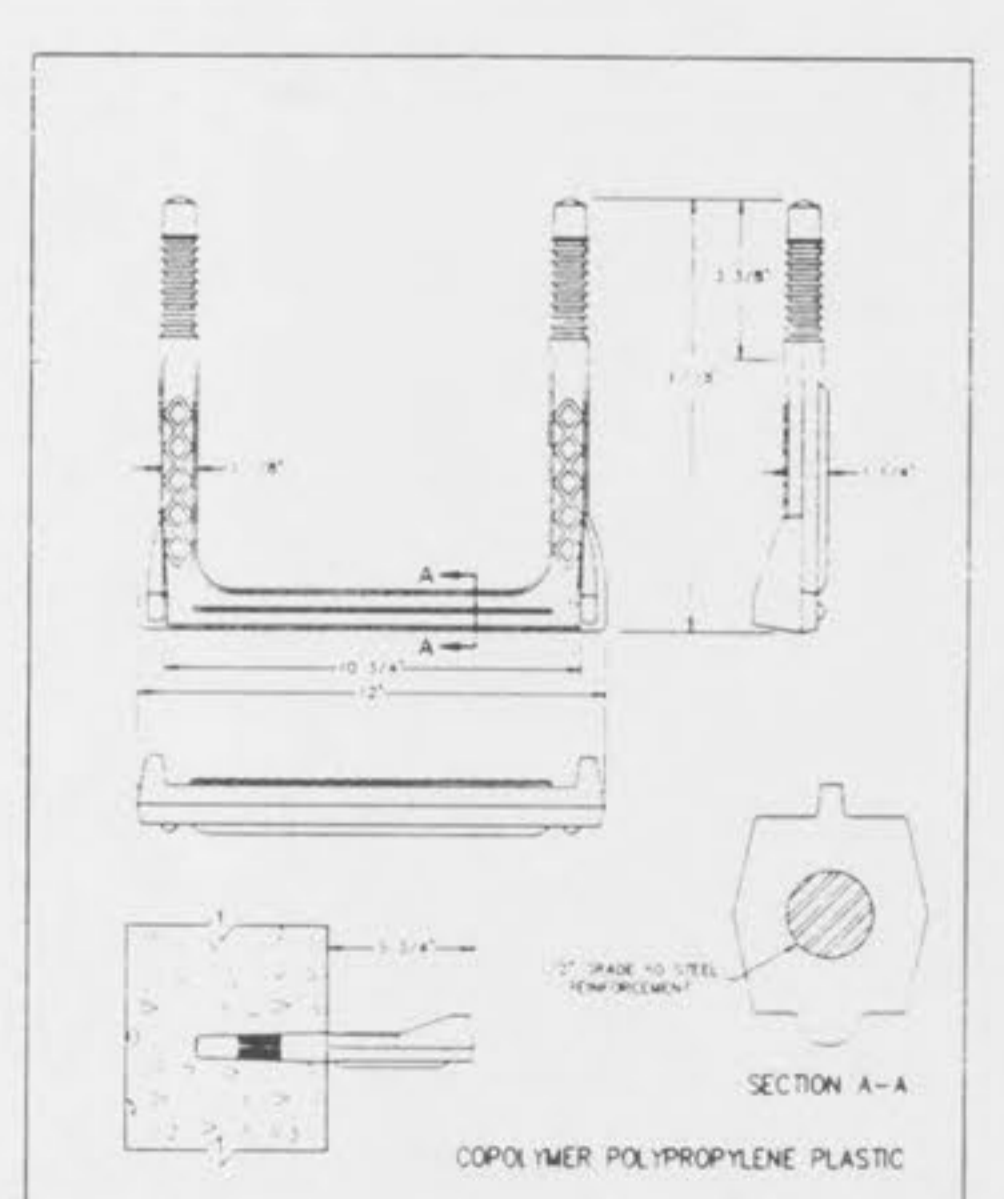

MANHOLE STEP FOR PRECAST MANHOLE METROPOLITAN ST. LOUIS SEWER DISTRICT Standard Details of Sewer Construction