

2 GRATE INLET
METROPOLITAN ST LOUIS SEWER DISTRICT
Standard Details of Sewer Construction
Dr. R.P.P. June 1984 Sheet 34

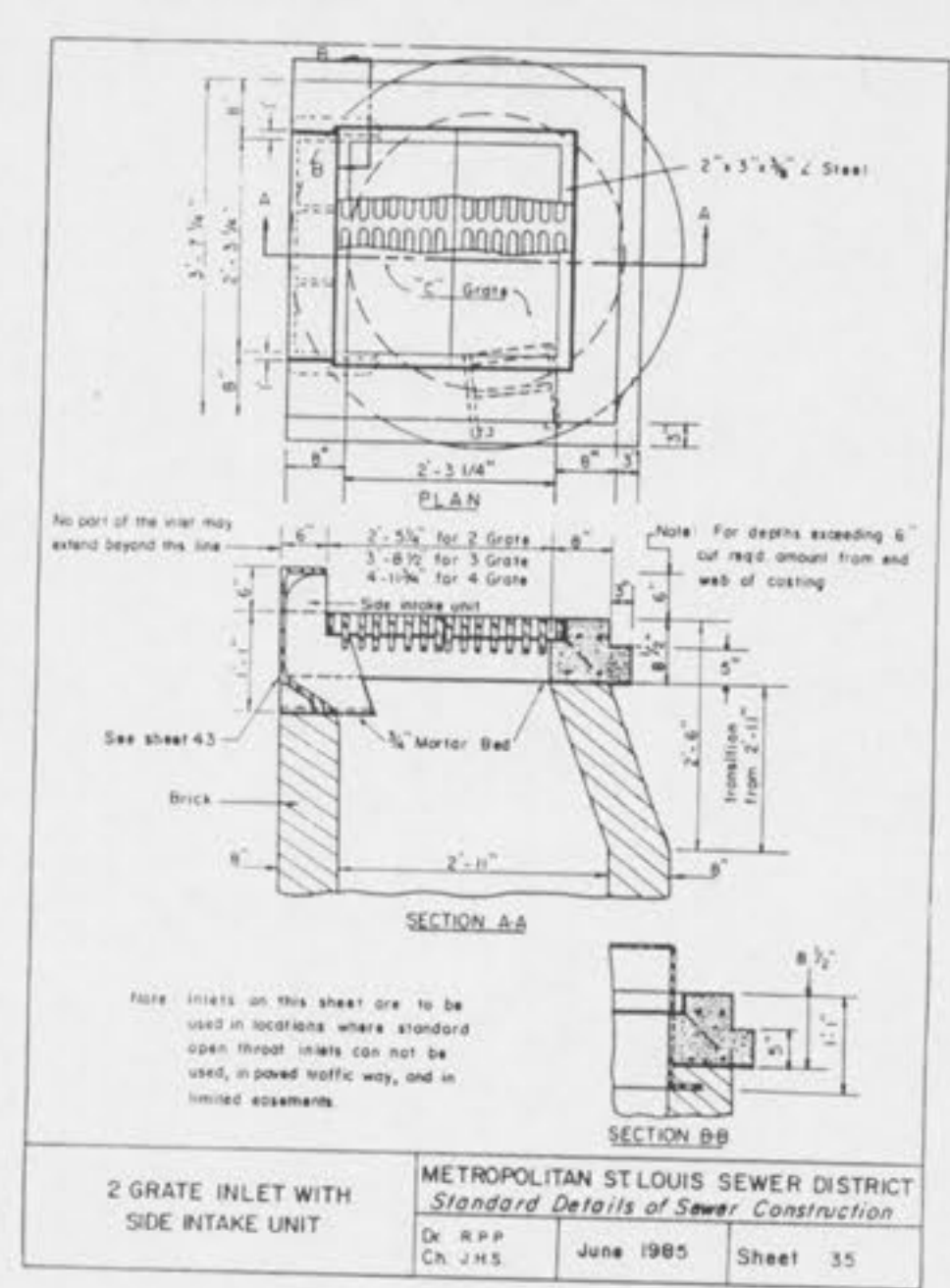

2 GRATE INLET WITH
SIDE INTAKE UNIT
METROPOLITAN ST LOUIS SEWER DISTRICT
Standard Details of Sewer Construction
Dr. R.P.P. June 1985 Sheet 35

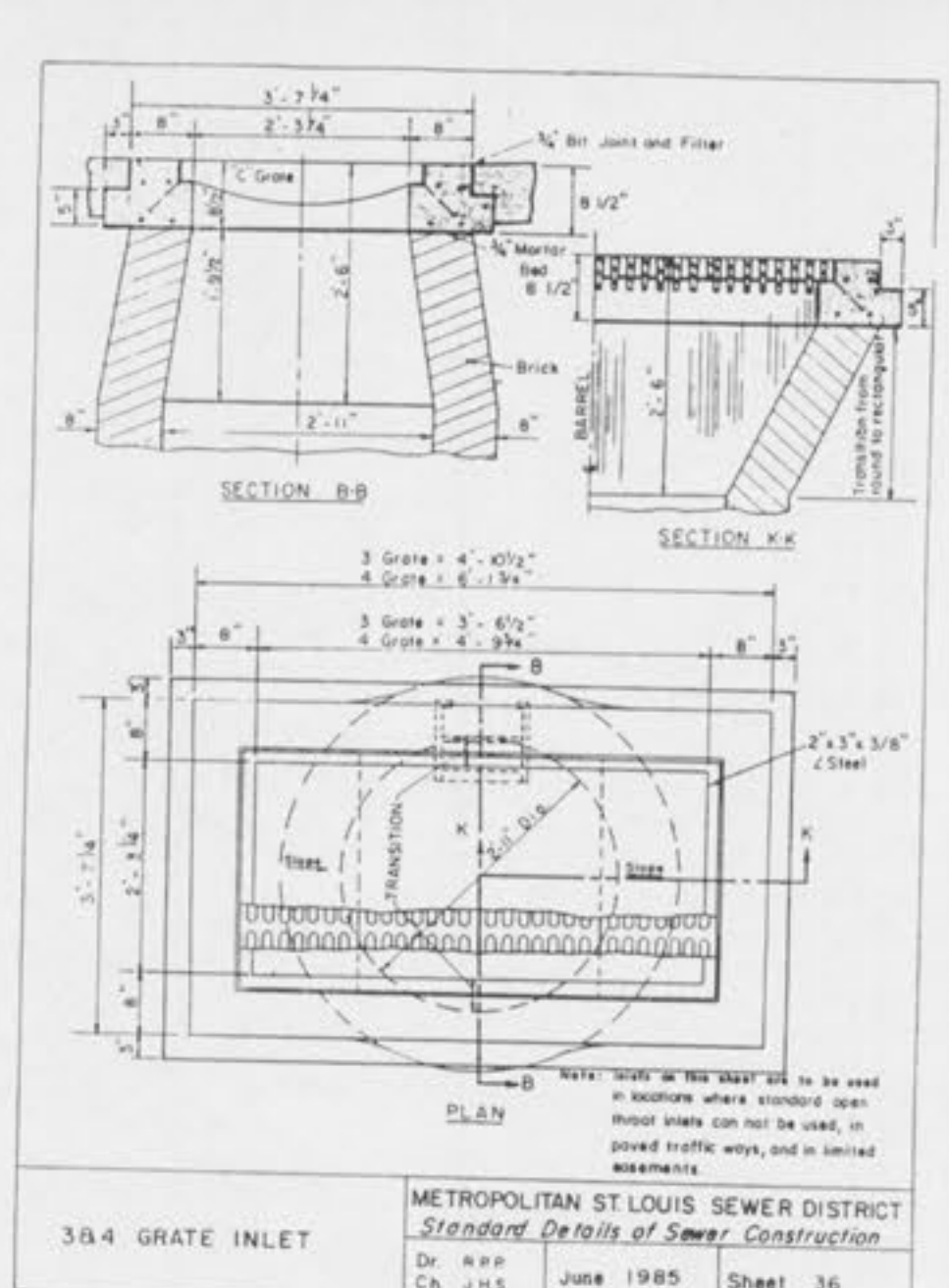

3 & 4 GRATE INLET
METROPOLITAN ST LOUIS SEWER DISTRICT
Standard Details of Sewer Construction
Dr. R.P.P. June 1985 Sheet 36

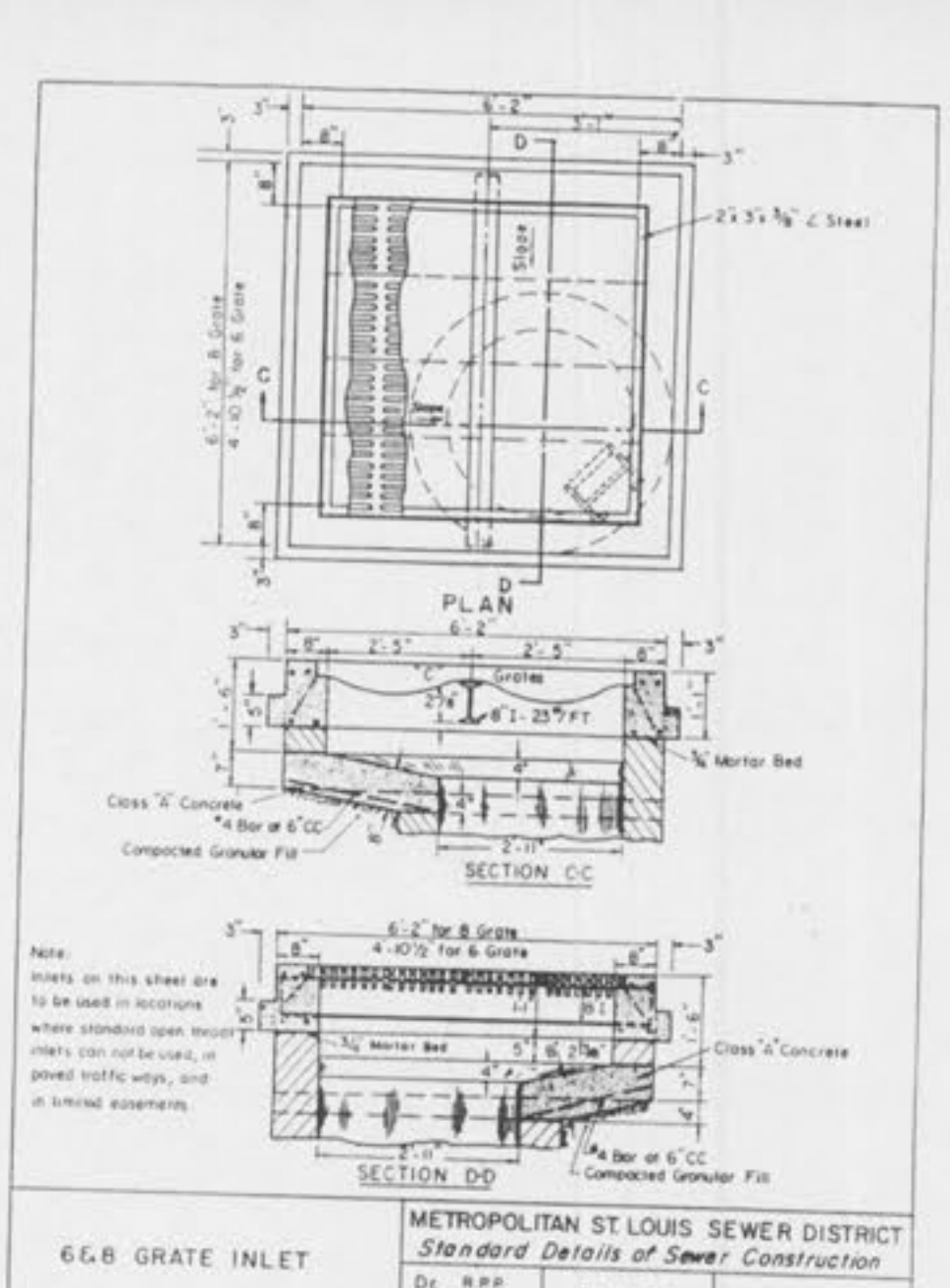

6 & 8 GRATE INLET
METROPOLITAN ST LOUIS SEWER DISTRICT
Standard Details of Sewer Construction
Dr. R.P.P. Feb. 1985 Sheet 37

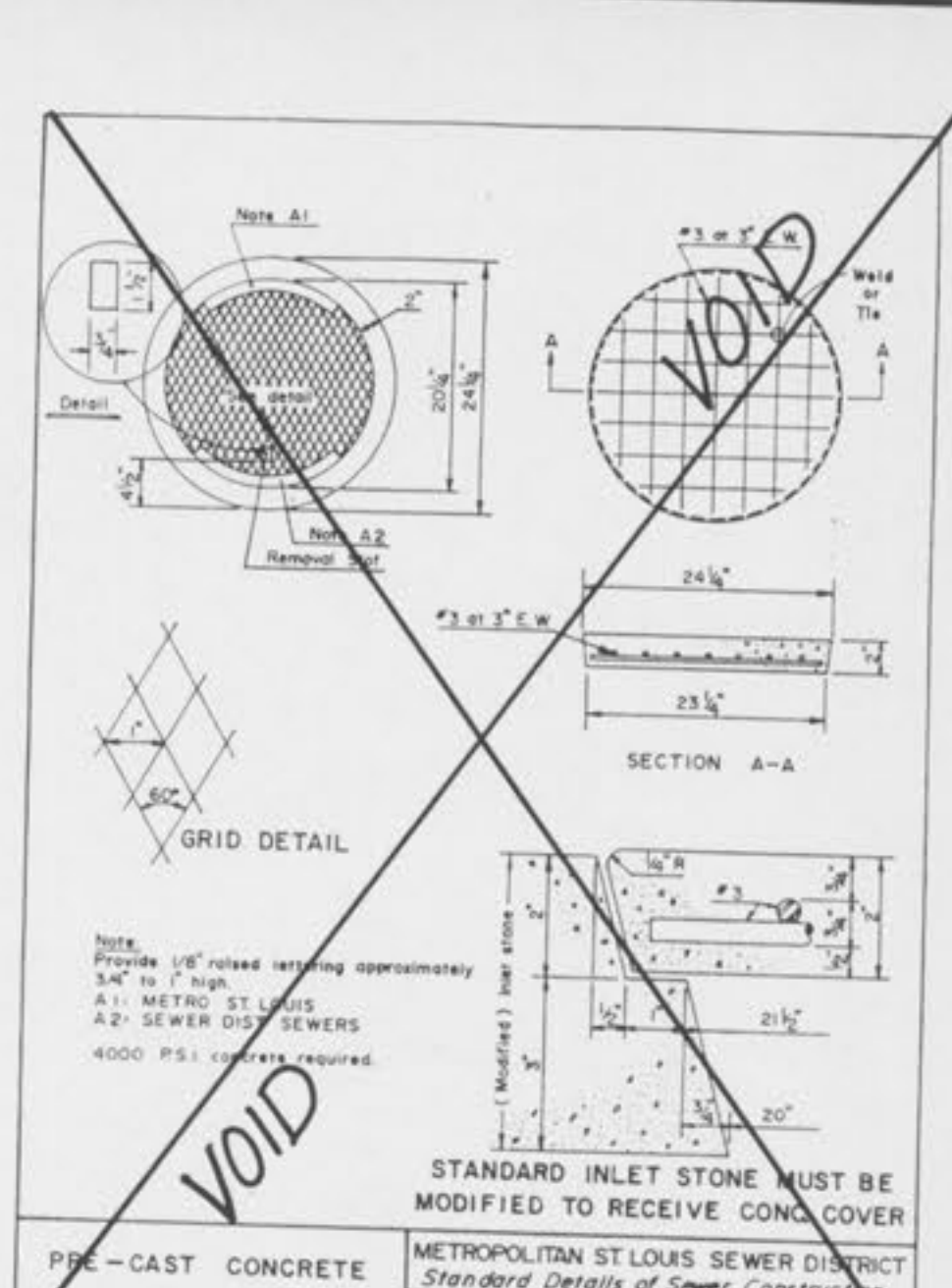

PIPE - CAST CONCRETE
INLET COVER
METROPOLITAN ST LOUIS SEWER DISTRICT
Standard Details of Sewer Construction
Dr. R.N. April 1985 Sheet 39

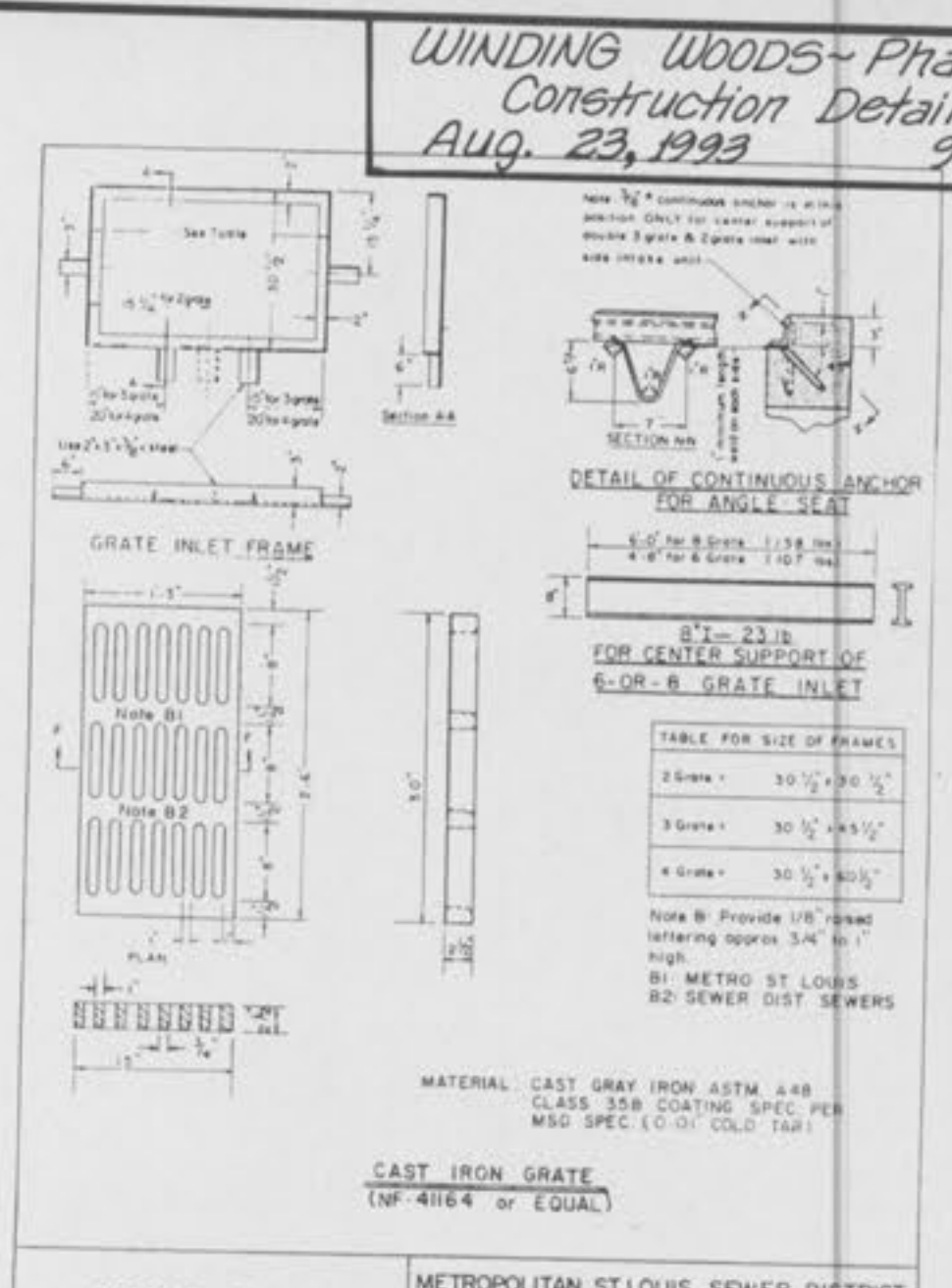

DETAILS OF INLET
FRAME AND GRATES
METROPOLITAN ST LOUIS SEWER DISTRICT
Standard Details of Sewer Construction
Dr. R.P.P. April 1985 Sheet 40

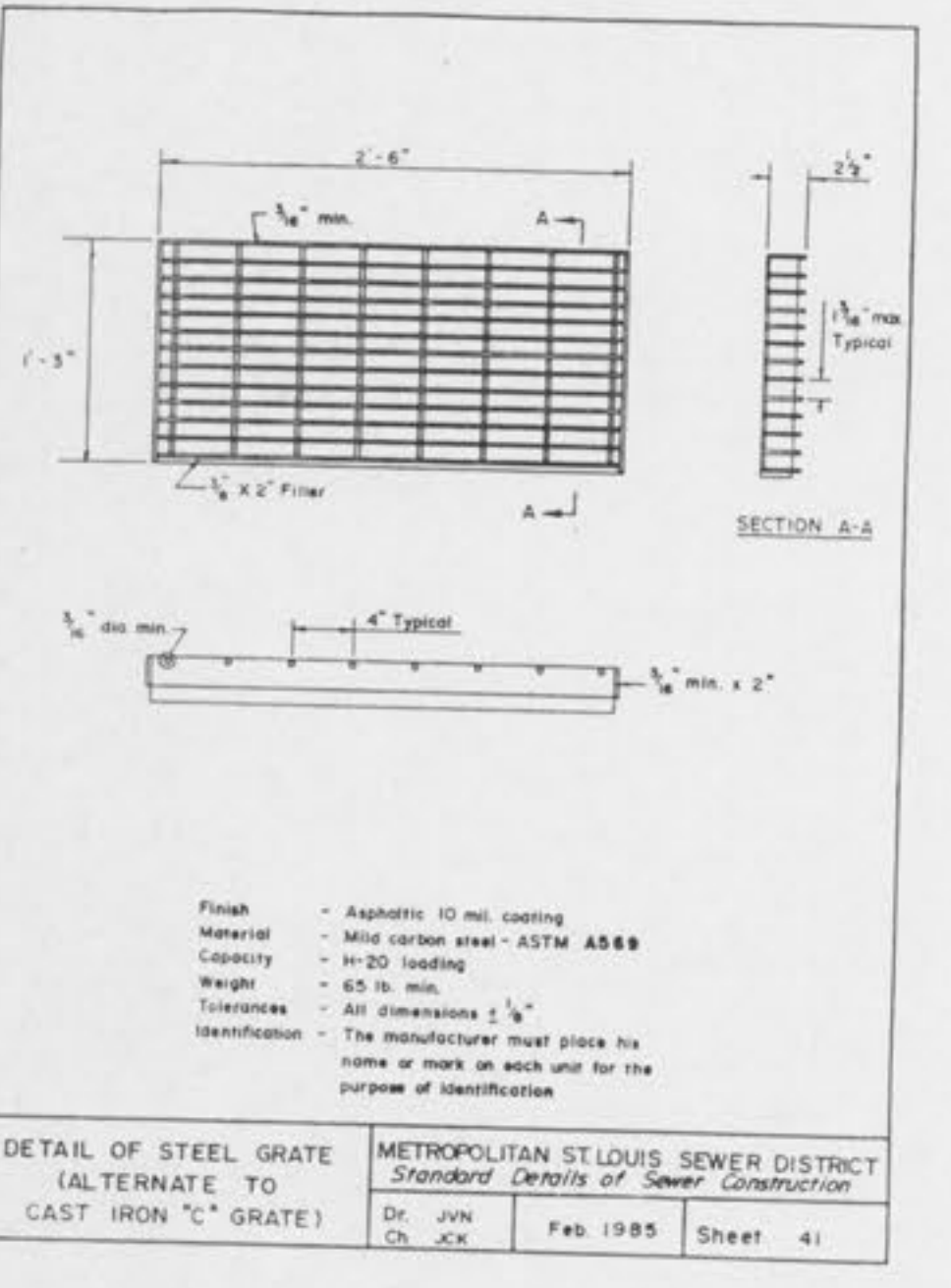

DETAIL OF STEEL GRATE
(ALTERNATE TO
CAST IRON 'C' GRATE)
METROPOLITAN ST LOUIS SEWER DISTRICT
Standard Details of Sewer Construction
Dr. J.V.N. Feb. 1985 Sheet 41

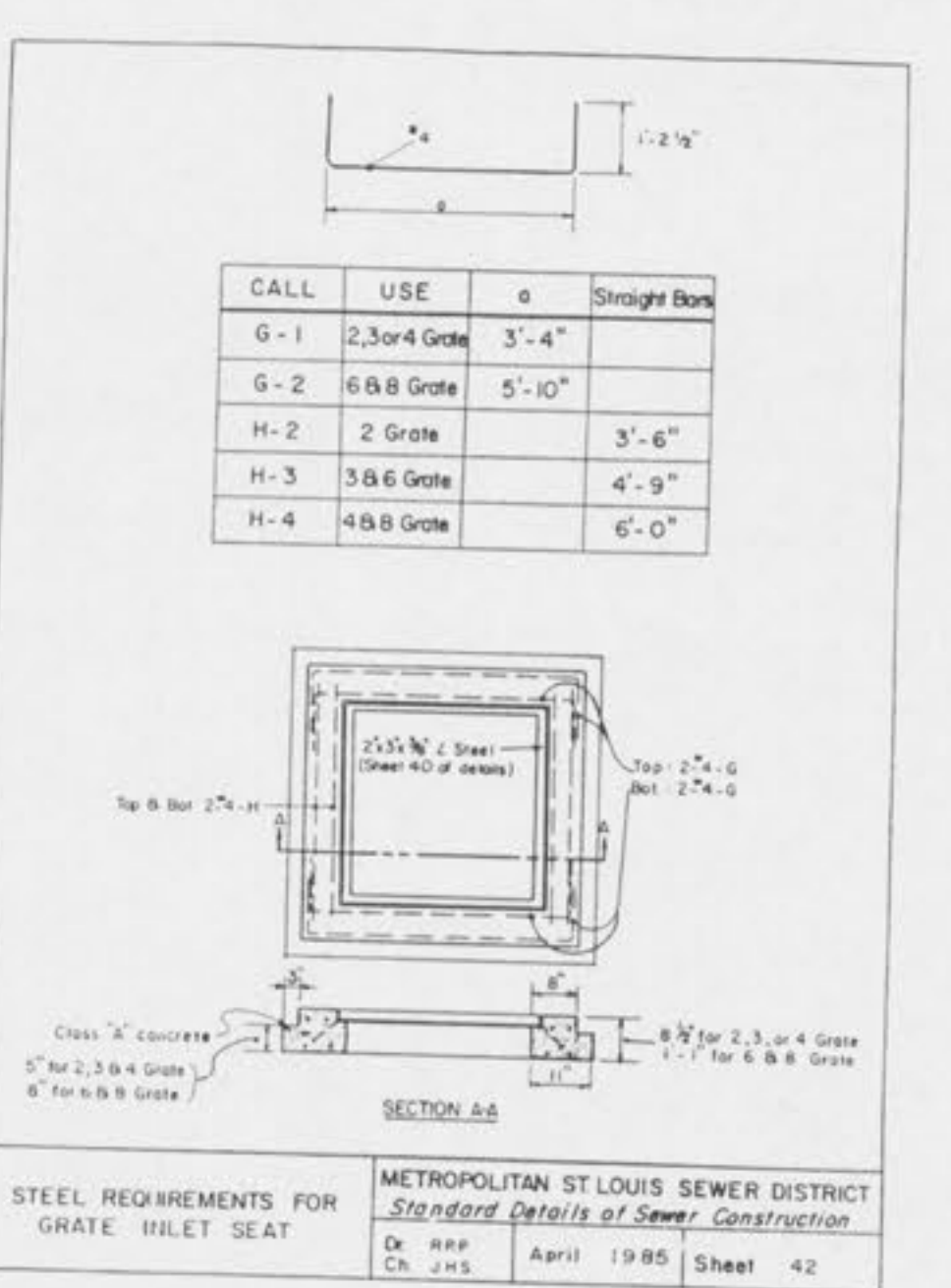

STEEL REQUIREMENTS FOR
GRATE INLET SEAT
METROPOLITAN ST LOUIS SEWER DISTRICT
Standard Details of Sewer Construction
Dr. R.P.P. April 1985 Sheet 42

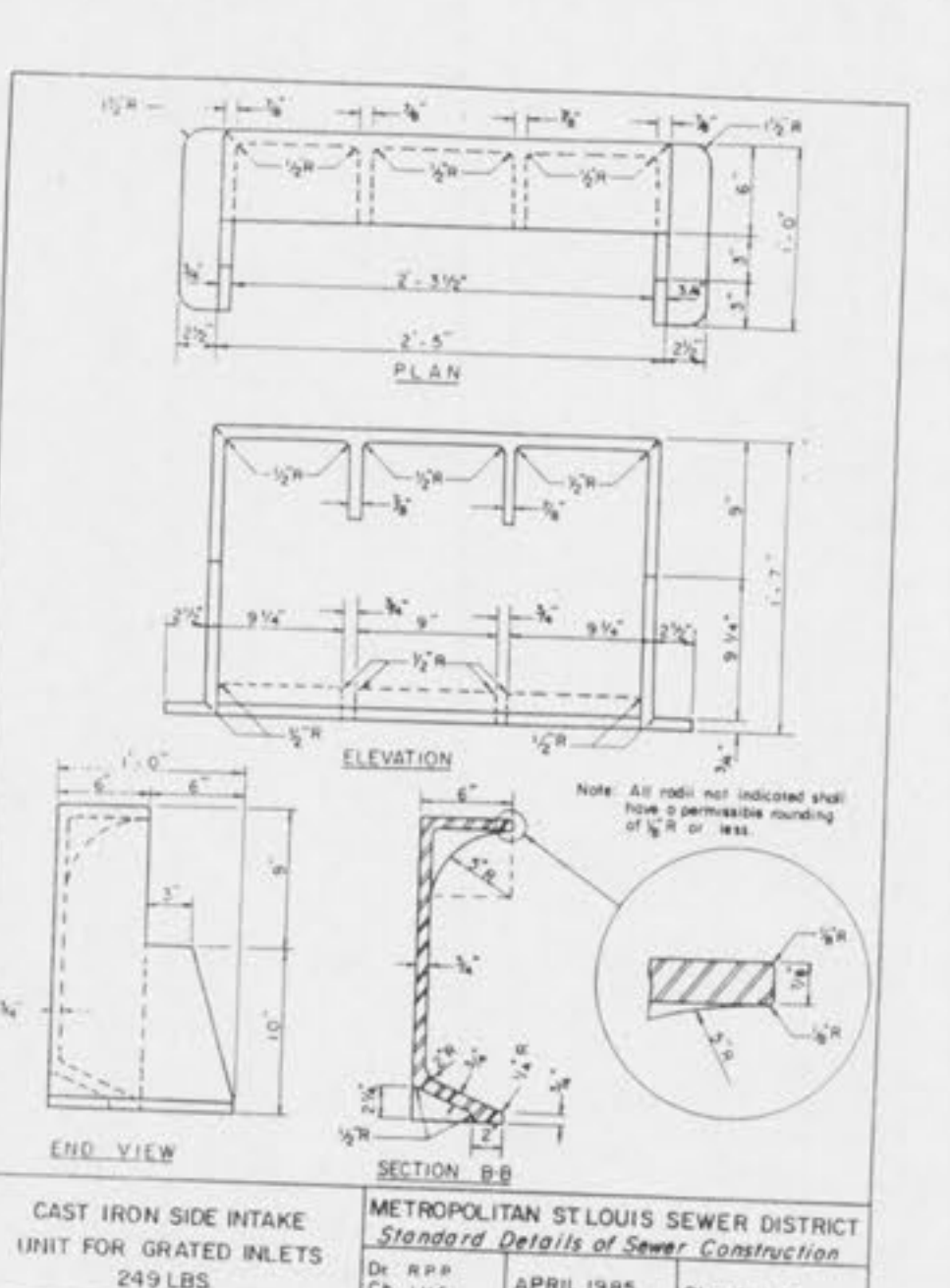

CAST IRON SIDE INTAKE
UNIT FOR GRATED INLETS
249 LBS.
METROPOLITAN ST LOUIS SEWER DISTRICT
Standard Details of Sewer Construction
Dr. R.P.P. April 1985 Sheet 43

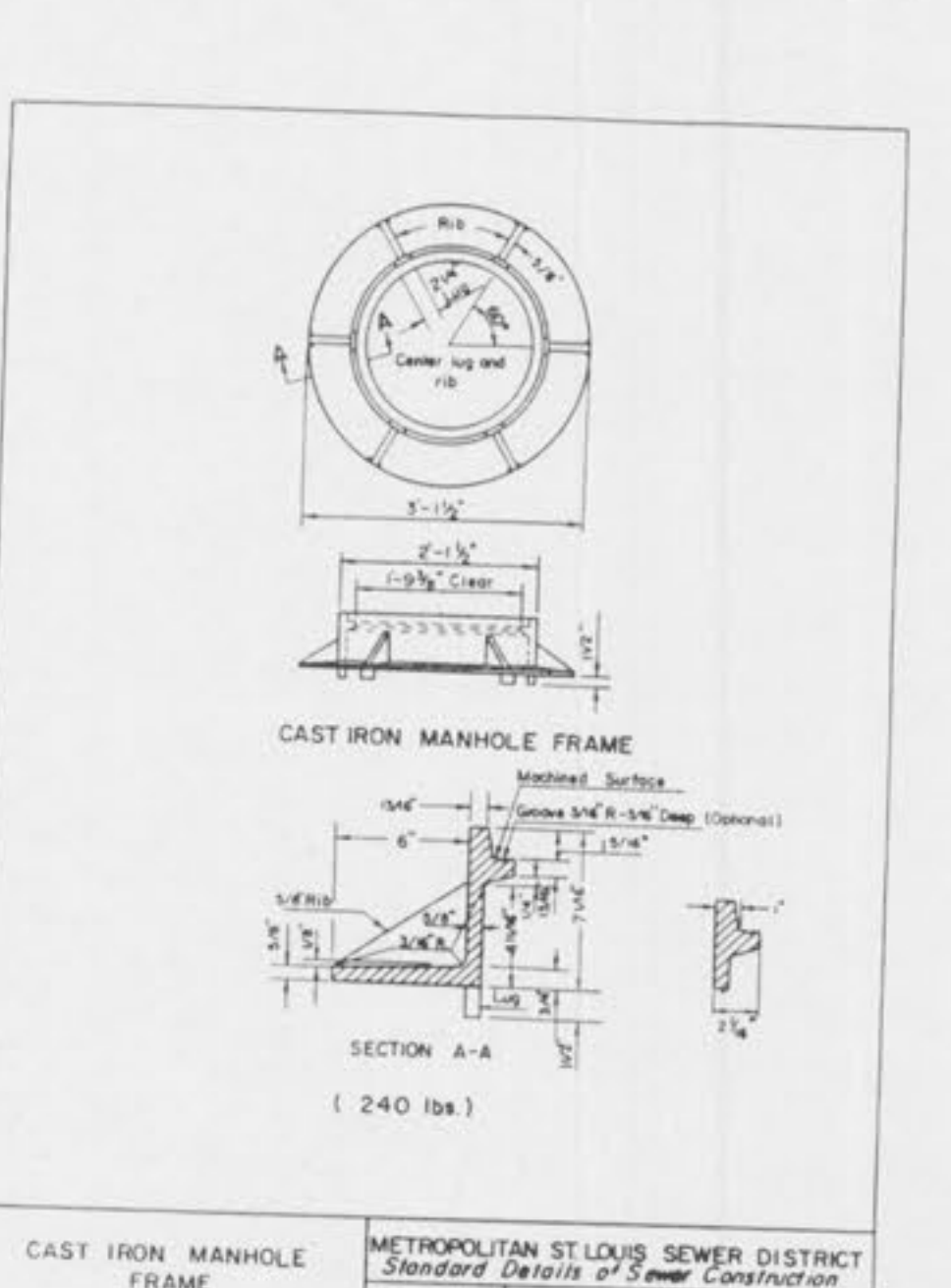

CAST IRON MANHOLE
FRAME
METROPOLITAN ST LOUIS SEWER DISTRICT
Standard Details of Sewer Construction
Dr. C.H.C. April 1979 Sheet 44

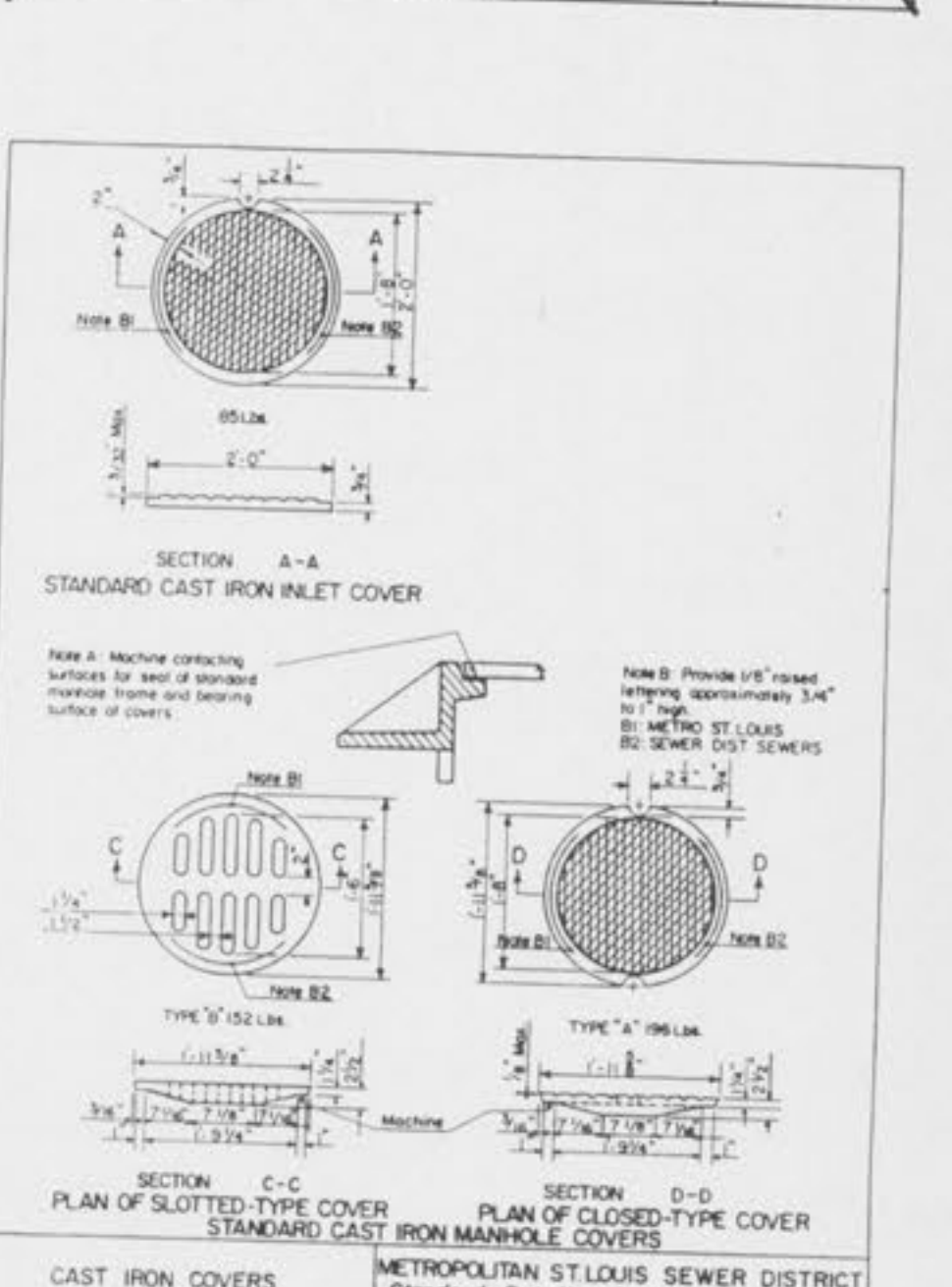

CAST IRON COVERS
MANHOLES AND INLETS
METROPOLITAN ST LOUIS SEWER DISTRICT
Standard Details of Sewer Construction
Dr. A.D.S. April 1985 Sheet 45

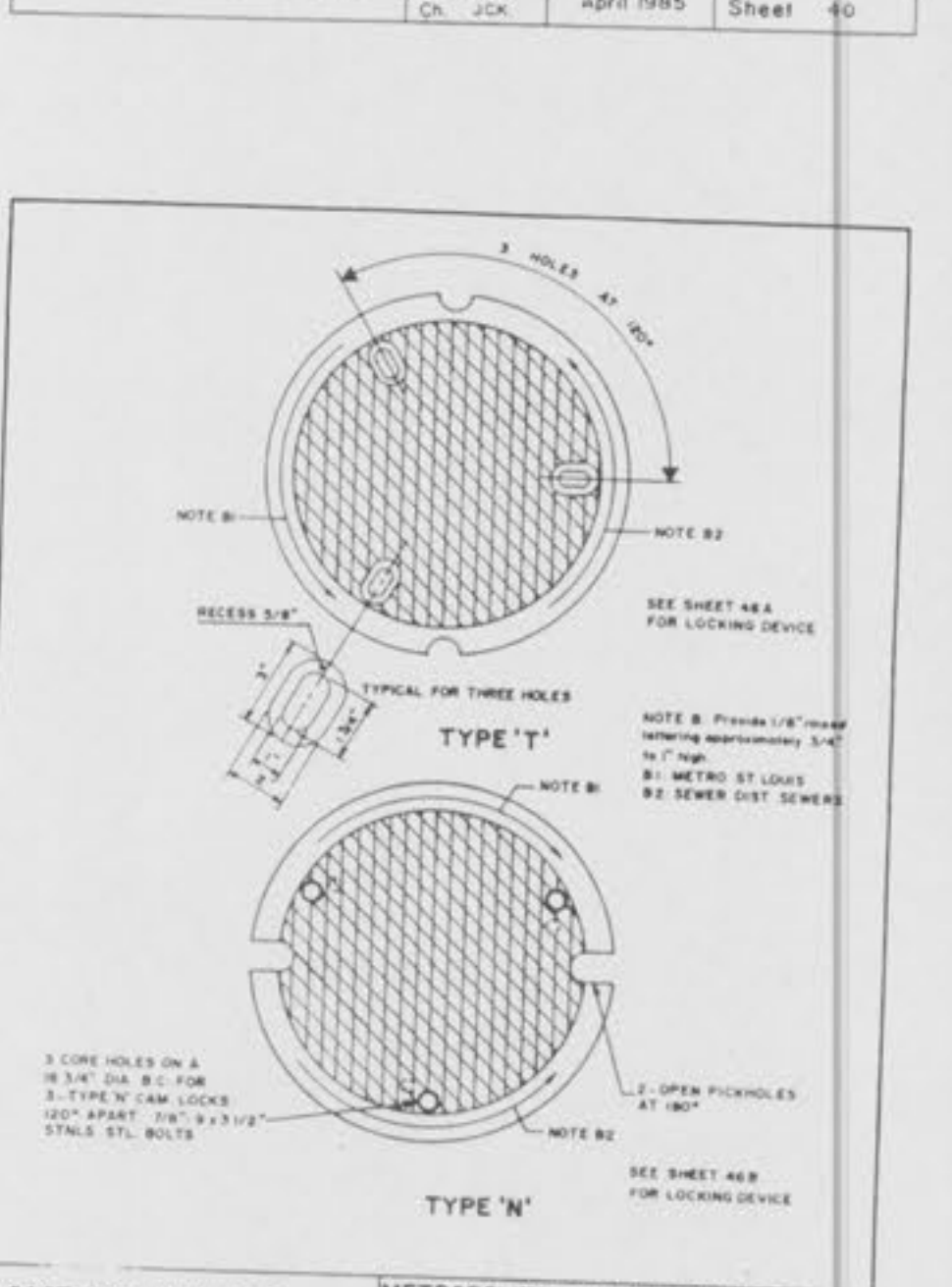

CAST IRON MANHOLE
COVERS
(LOCK TYPE)
METROPOLITAN ST LOUIS SEWER DISTRICT
Standard Details of Sewer Construction
Dr. R.J.S. April 1984 Sheet 46

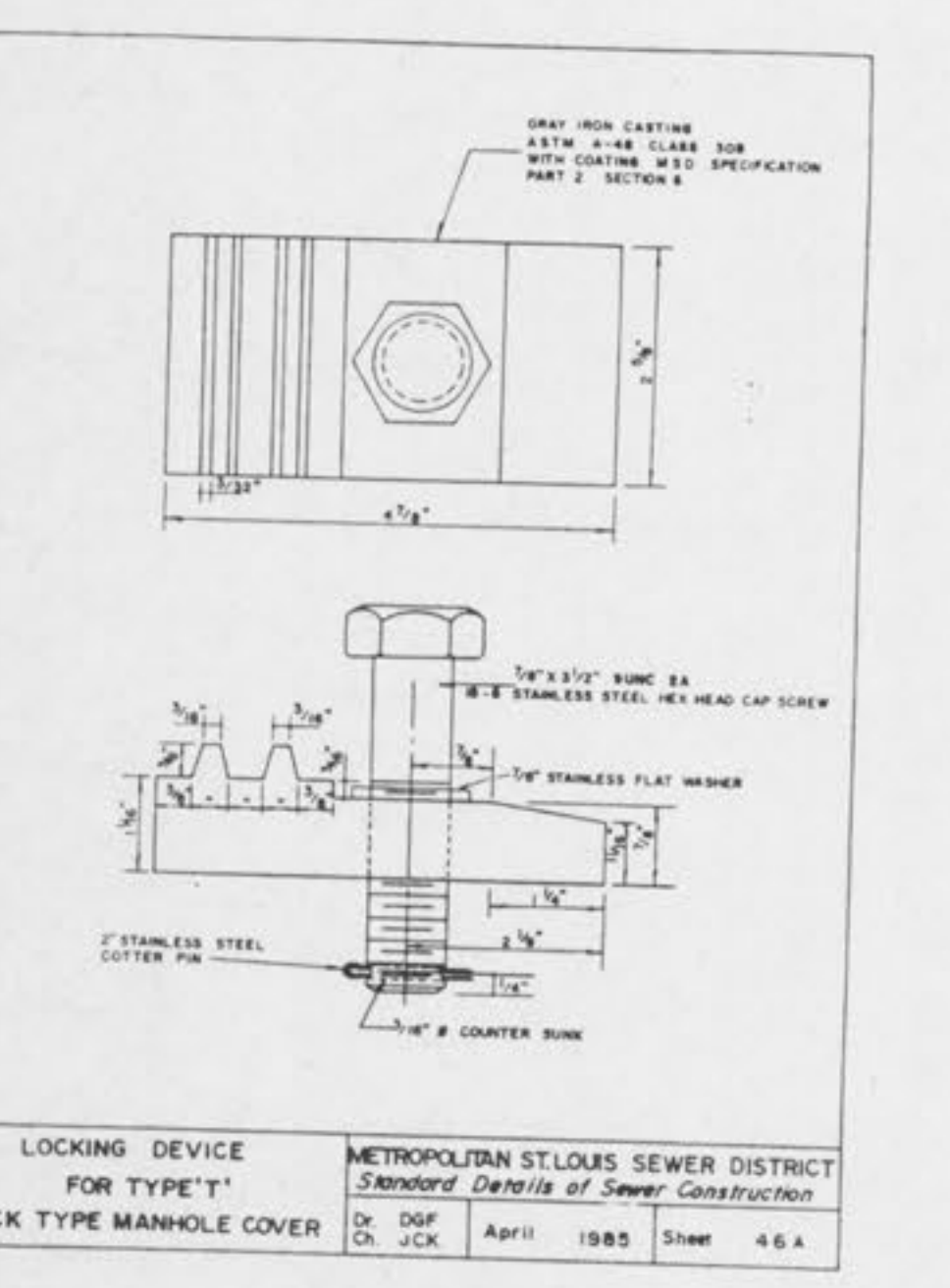

LOCKING DEVICE
FOR TYPE 'T'
LOCK TYPE MANHOLE COVER
METROPOLITAN ST LOUIS SEWER DISTRICT
Standard Details of Sewer Construction
Dr. D.G.P. April 1985 Sheet 46 x

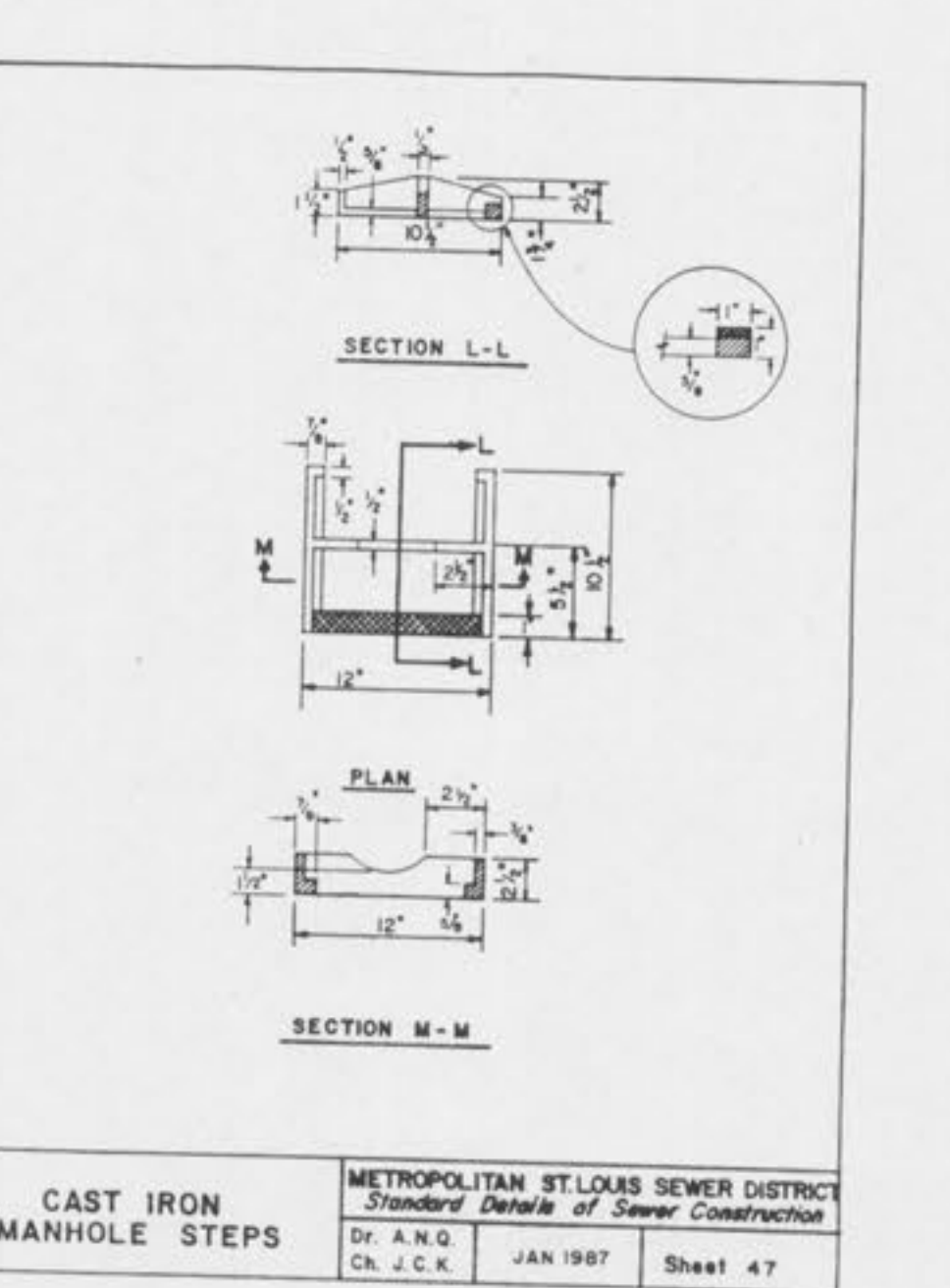

CAST IRON
MANHOLE STEPS
METROPOLITAN ST LOUIS SEWER DISTRICT
Standard Details of Sewer Construction
Dr. A.N.O. Jan 1987 Sheet 47

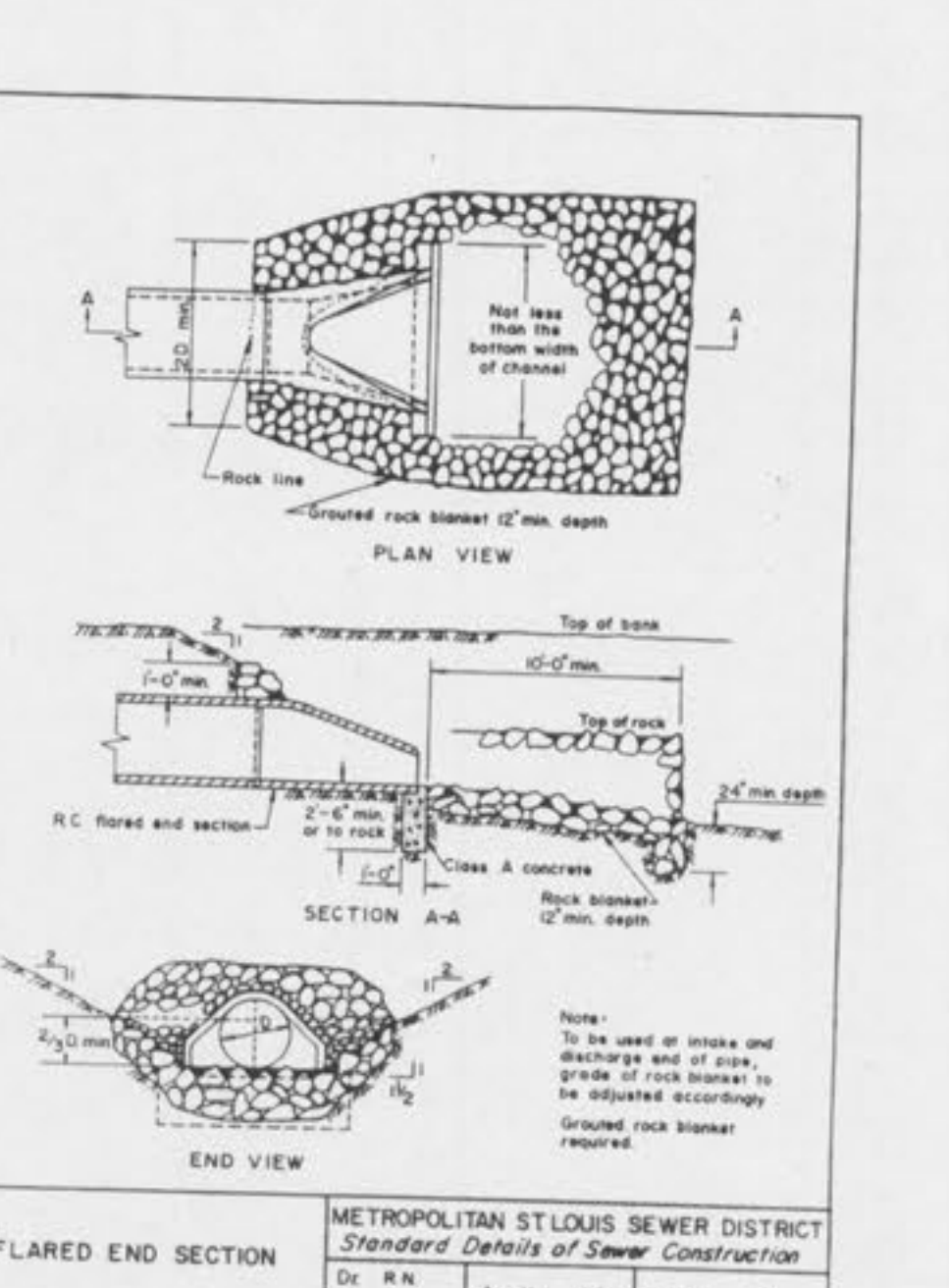

FLARED END SECTION
METROPOLITAN ST LOUIS SEWER DISTRICT
Standard Details of Sewer Construction
Dr. W.K. April 1979 Sheet 48

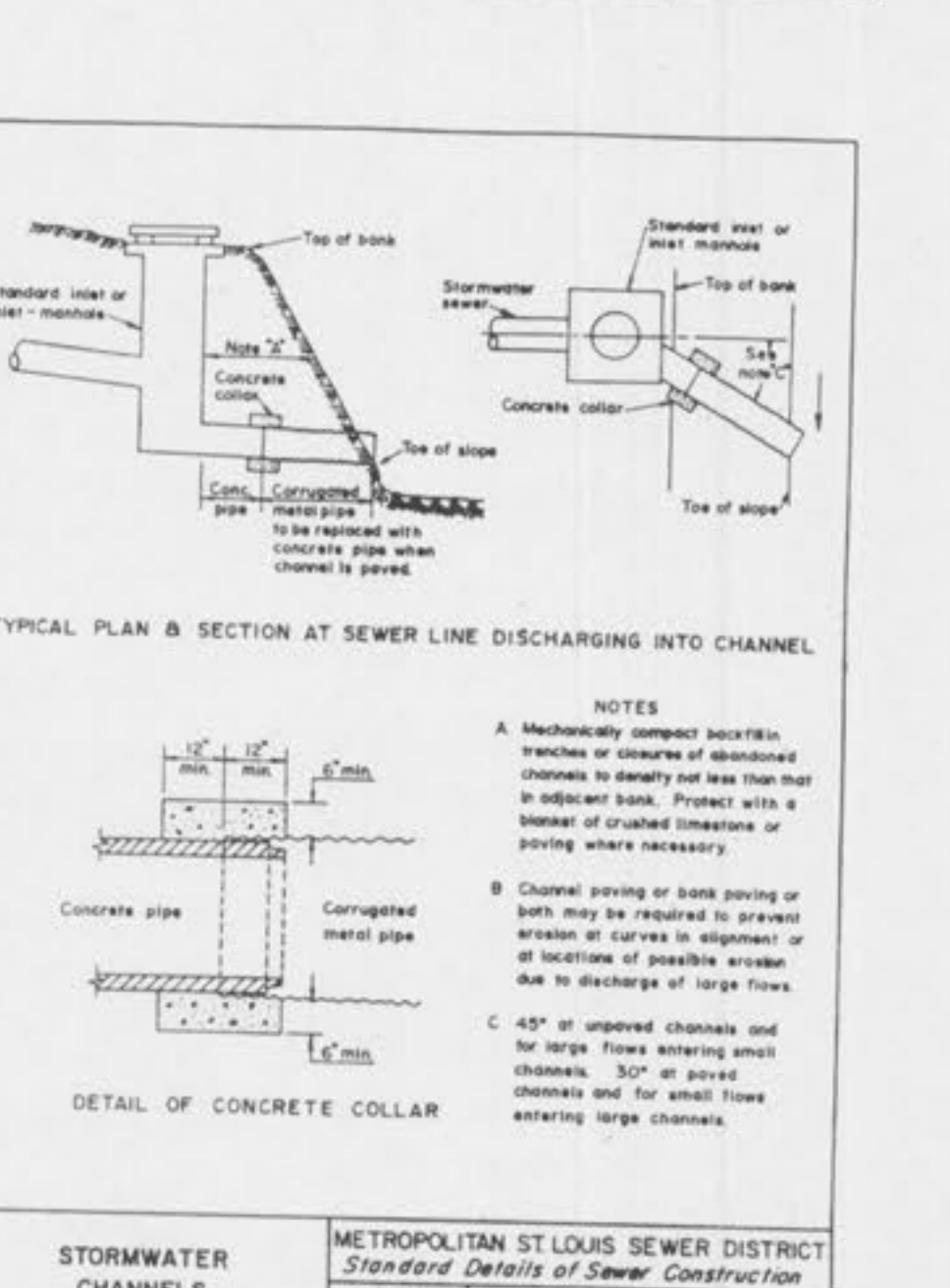

STORMWATER
CHANNELS
METROPOLITAN ST LOUIS SEWER DISTRICT
Standard Details of Sewer Construction
Dr. R.N. April 1985 Sheet 49

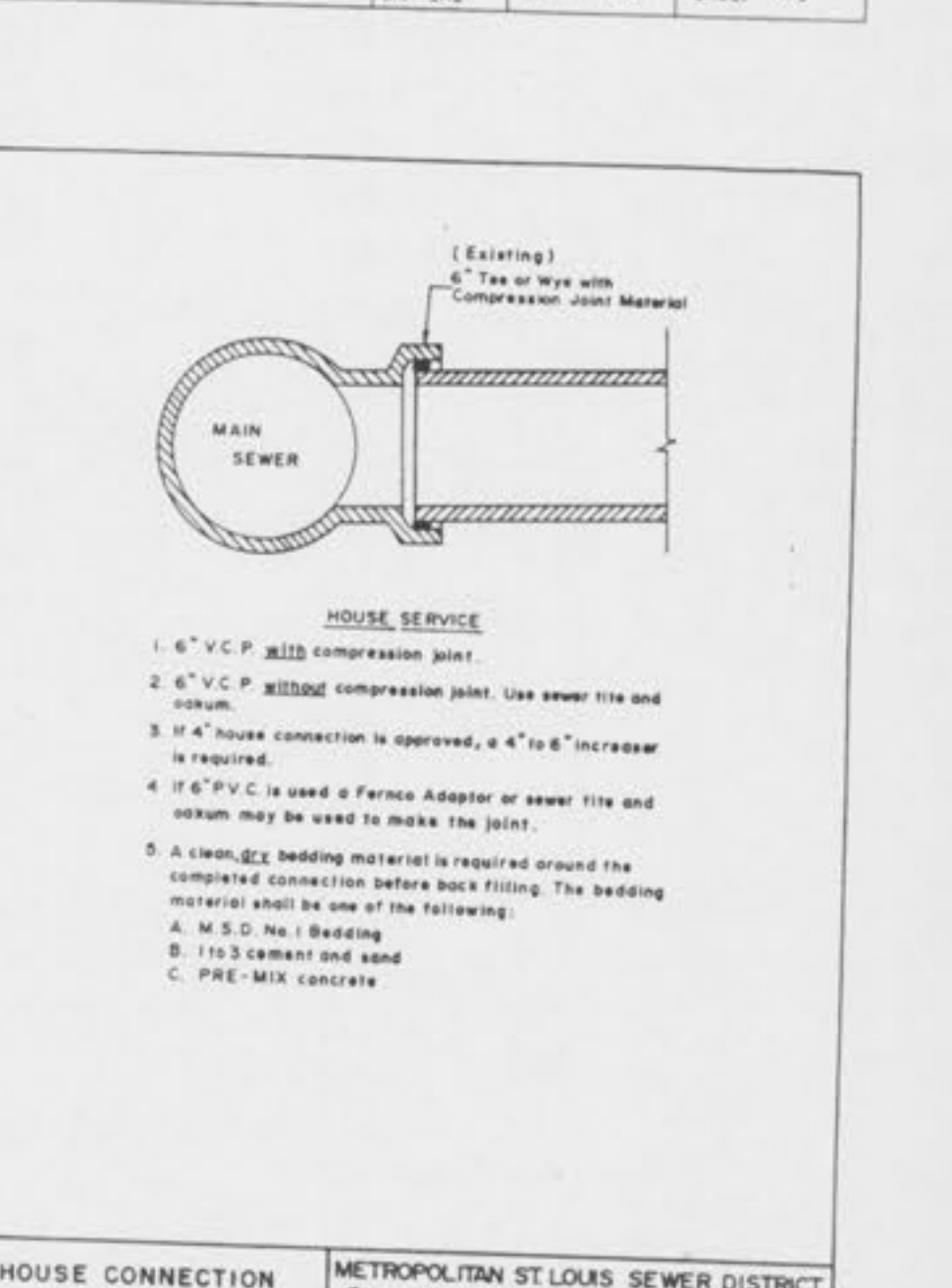

HOUSE CONNECTION
TO EXISTING
TEE OR WYE
METROPOLITAN ST LOUIS SEWER DISTRICT
Standard Details of Sewer Construction
Dr. A.E.S. April 1978 Sheet 50

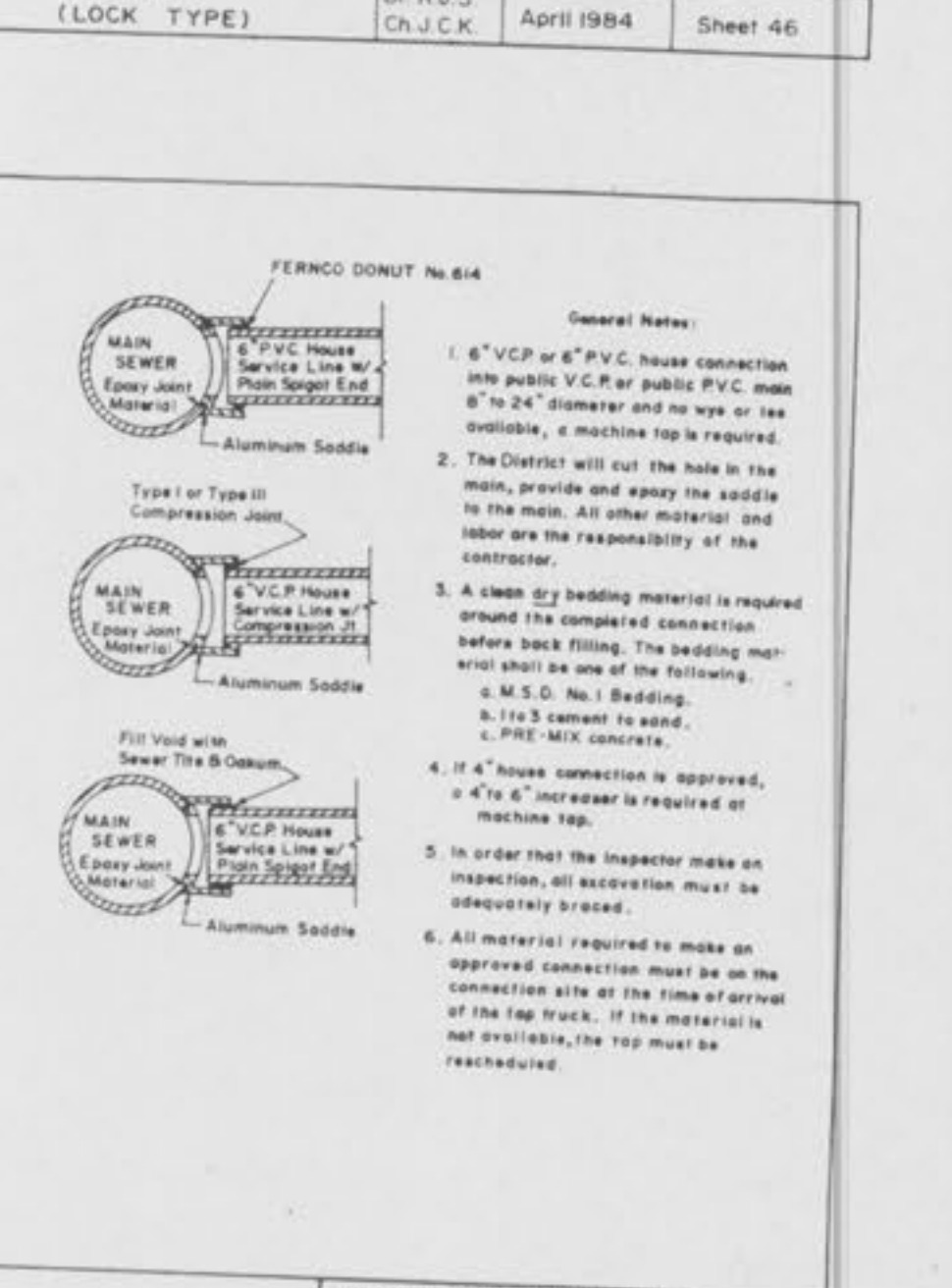

MACHINE TAP
METROPOLITAN ST LOUIS SEWER DISTRICT
Standard Details of Sewer Construction
Dr. A.E.S. April 1979 Sheet 51