

ROUND PIPE				HORIZONTAL ELLIPTICAL PIPE			
DIAMETER OF PIPE (INCHES)	PAVING DEPTH (INCHES)	PAVING DEPTH (INCHES)	PAVING DEPTH (INCHES)	DIAMETER OF PIPE (INCHES)	PAVING DEPTH (INCHES)	PAVING DEPTH (INCHES)	PAVING DEPTH (INCHES)
6	30	230	230	6	30	230	230
8	30	230	230	8	30	230	230
10	30	230	230	10	30	230	230
12	30	230	230	12	30	230	230
14	30	230	230	14	30	230	230
16	30	230	230	16	30	230	230
18	30	230	230	18	30	230	230
20	30	230	230	20	30	230	230
22	30	230	230	22	30	230	230
24	30	230	230	24	30	230	230
26	30	230	230	26	30	230	230
28	30	230	230	28	30	230	230
30	30	230	230	30	30	230	230
32	30	230	230	32	30	230	230
34	30	230	230	34	30	230	230
36	30	230	230	36	30	230	230
38	30	230	230	38	30	230	230
40	30	230	230	40	30	230	230
42	30	230	230	42	30	230	230
44	30	230	230	44	30	230	230
46	30	230	230	46	30	230	230
48	30	230	230	48	30	230	230
50	30	230	230	50	30	230	230
52	30	230	230	52	30	230	230
54	30	230	230	54	30	230	230
56	30	230	230	56	30	230	230
58	30	230	230	58	30	230	230
60	30	230	230	60	30	230	230
62	30	230	230	62	30	230	230
64	30	230	230	64	30	230	230
66	30	230	230	66	30	230	230
68	30	230	230	68	30	230	230
70	30	230	230	70	30	230	230
72	30	230	230	72	30	230	230
74	30	230	230	74	30	230	230
76	30	230	230	76	30	230	230
78	30	230	230	78	30	230	230
80	30	230	230	80	30	230	230
82	30	230	230	82	30	230	230
84	30	230	230	84	30	230	230
86	30	230	230	86	30	230	230
88	30	230	230	88	30	230	230
90	30	230	230	90	30	230	230
92	30	230	230	92	30	230	230
94	30	230	230	94	30	230	230
96	30	230	230	96	30	230	230
98	30	230	230	98	30	230	230
100	30	230	230	100	30	230	230

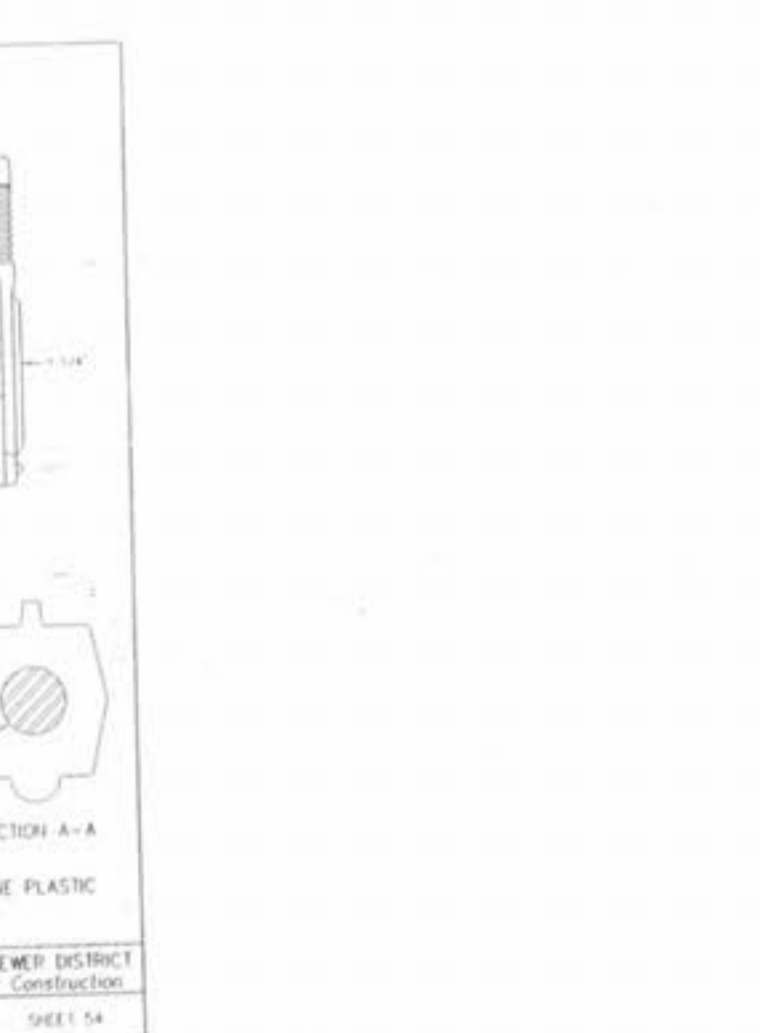
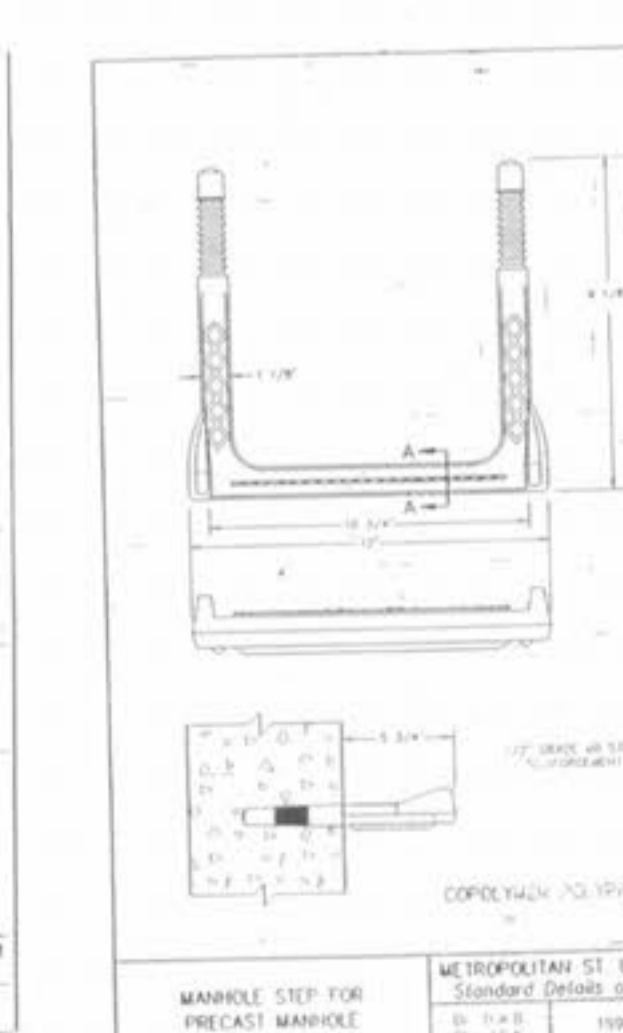
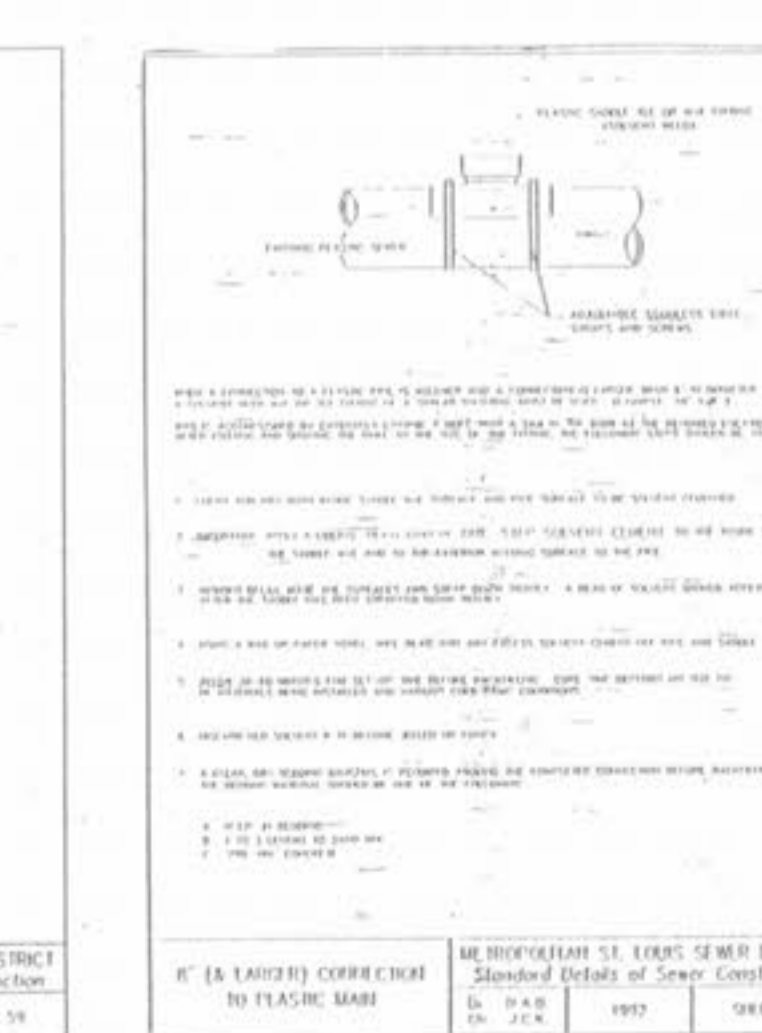
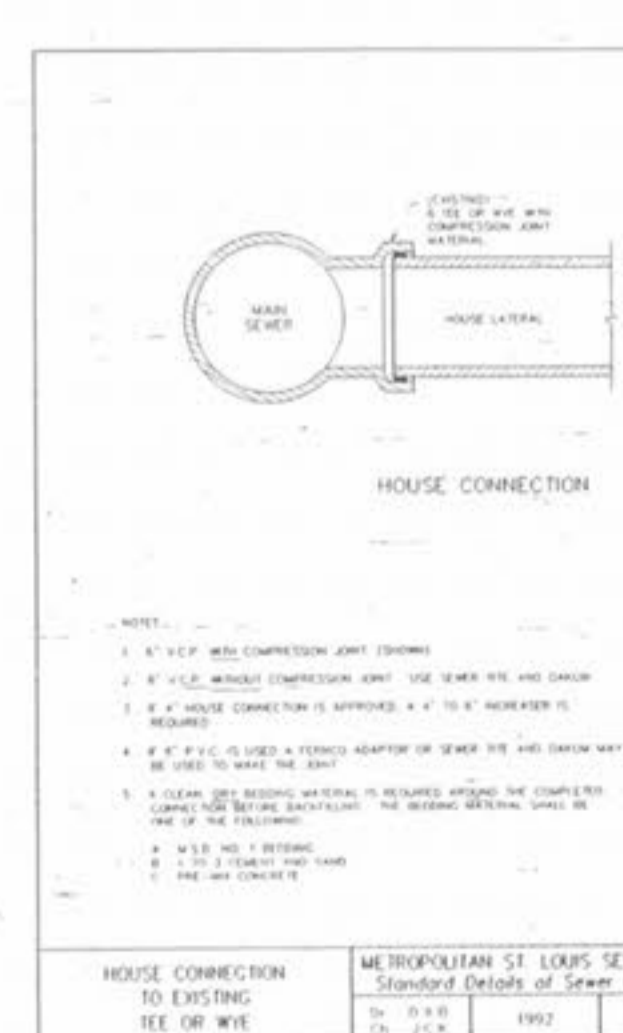
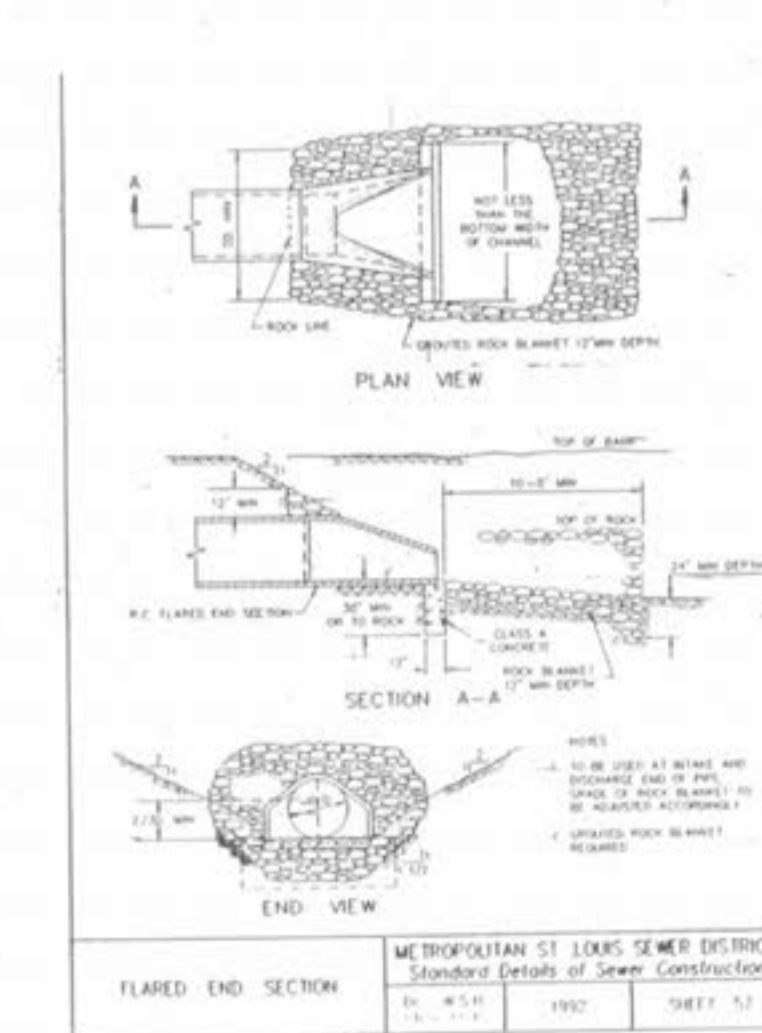
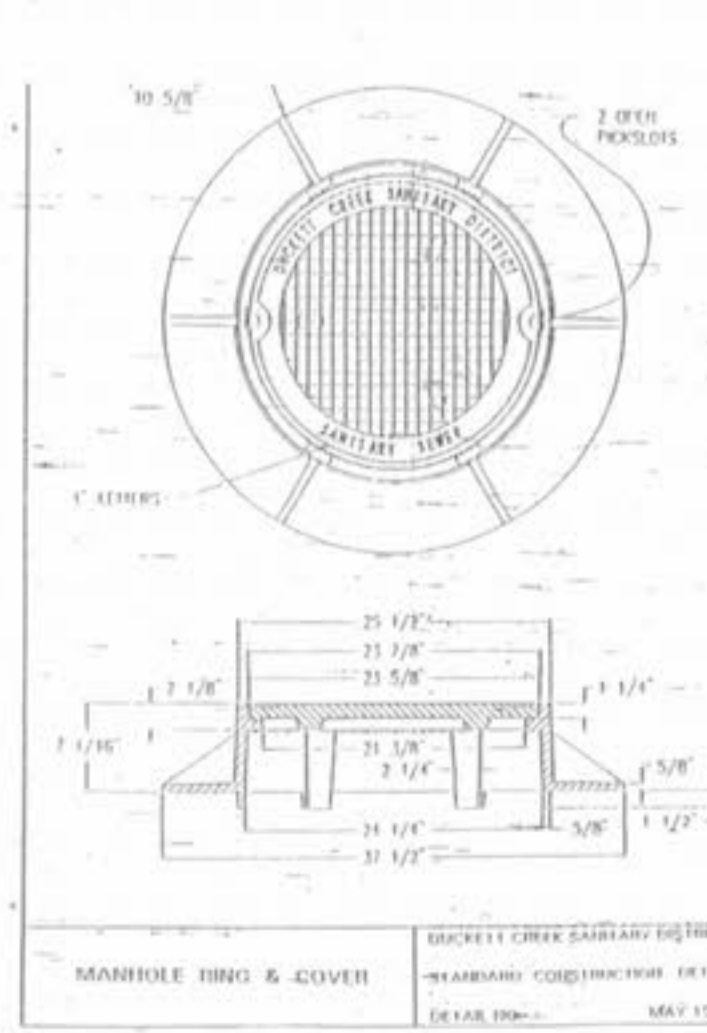
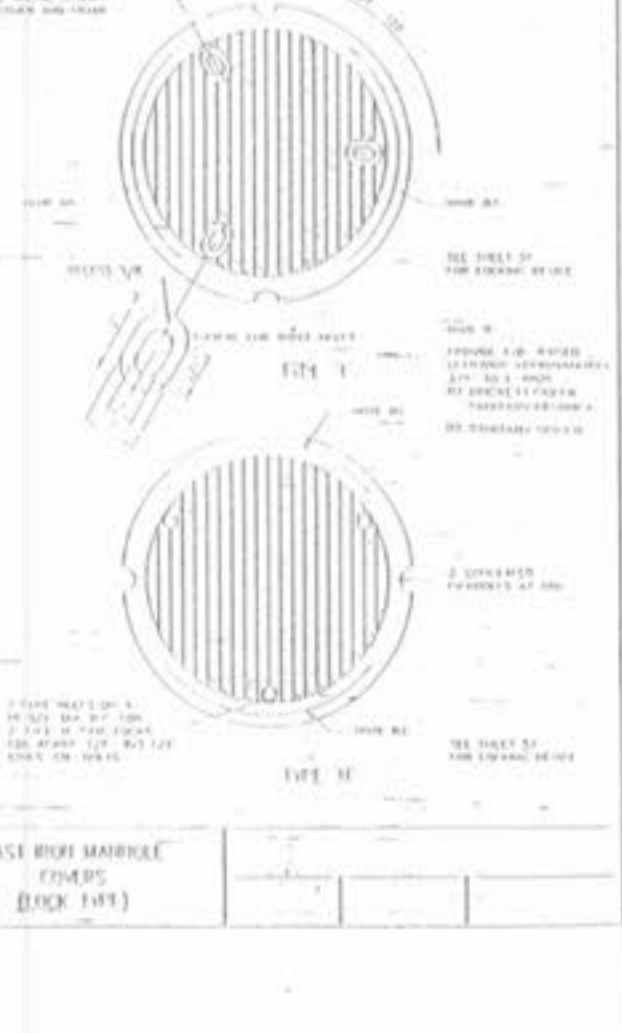
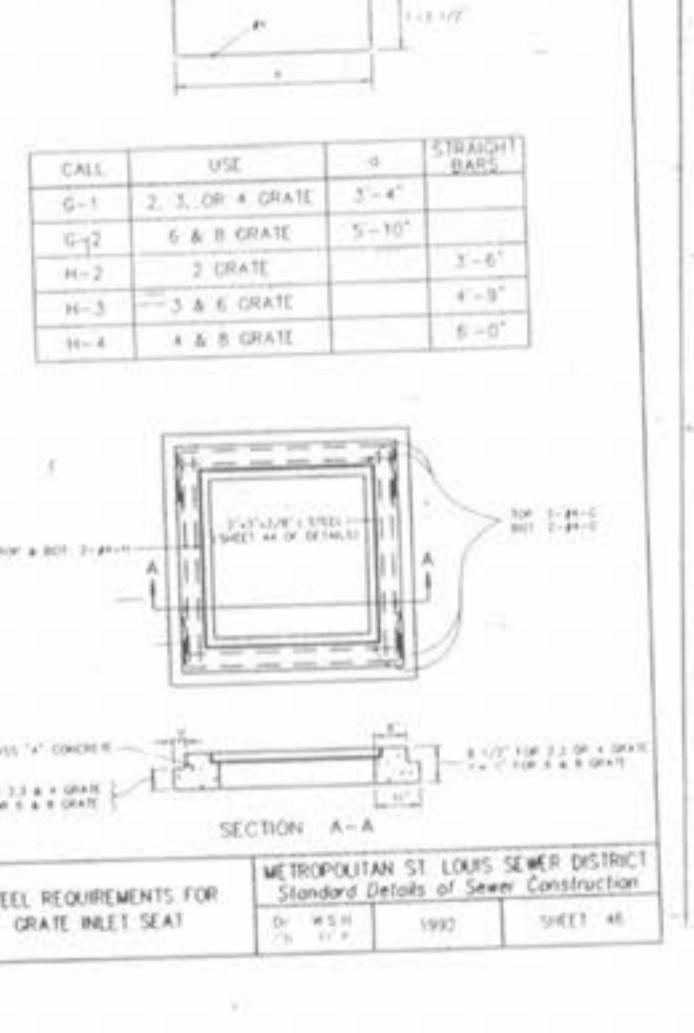
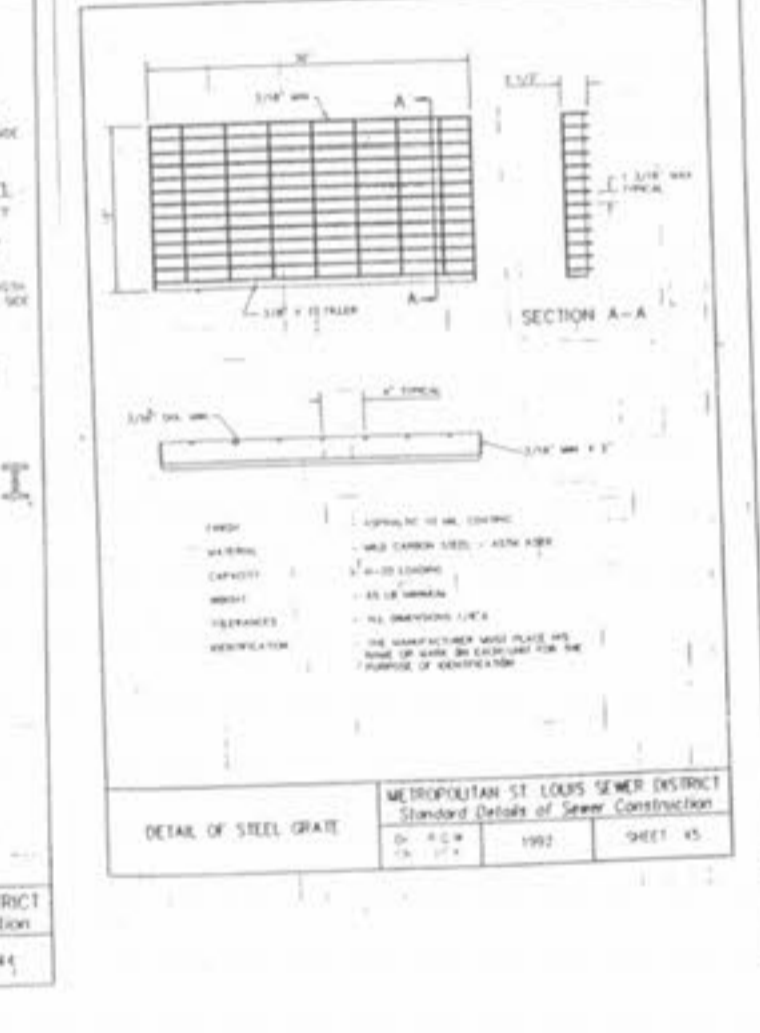
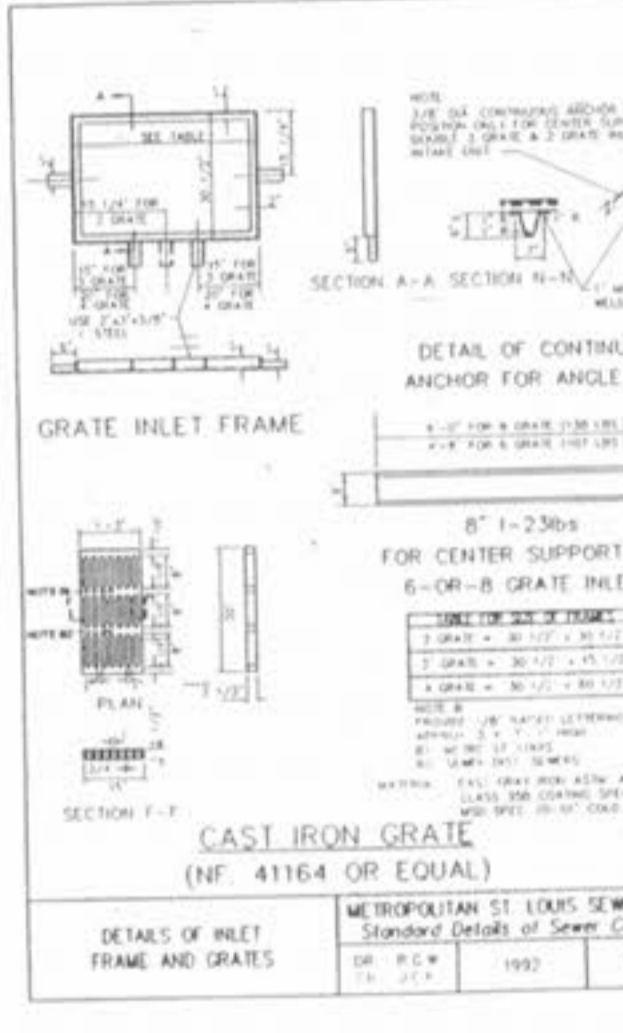
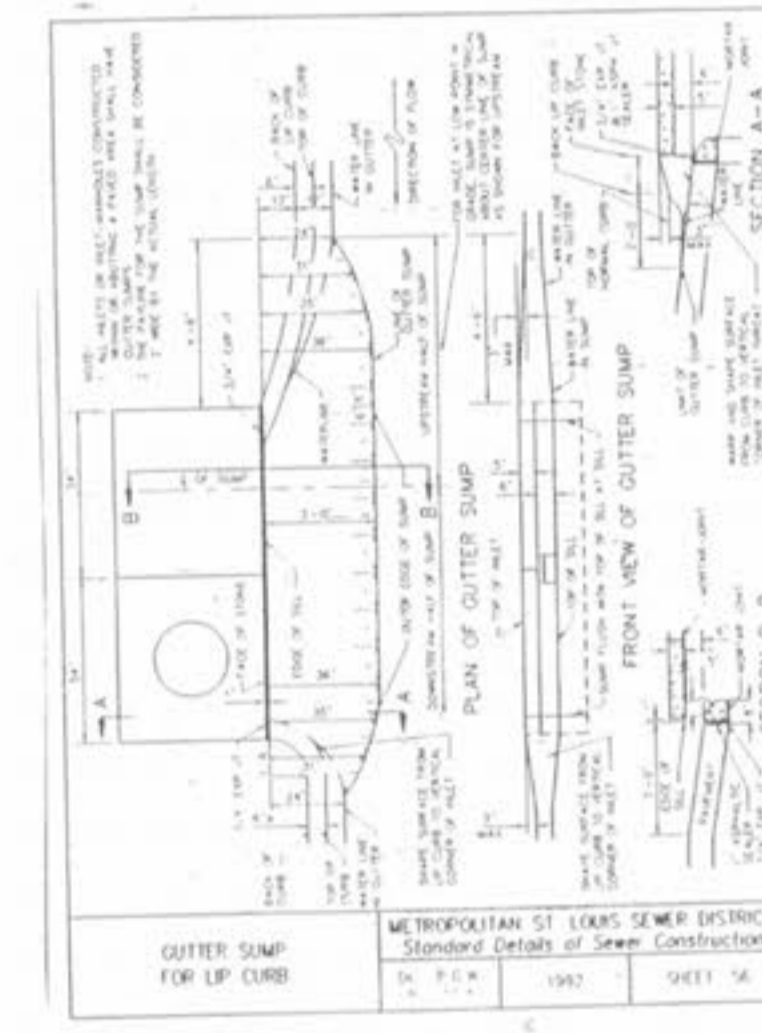
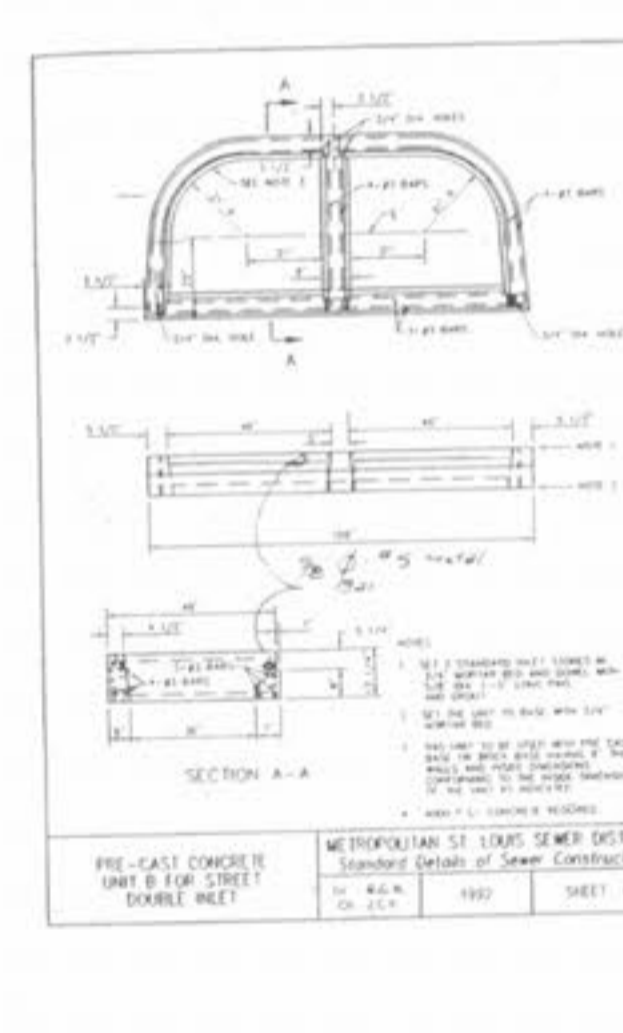
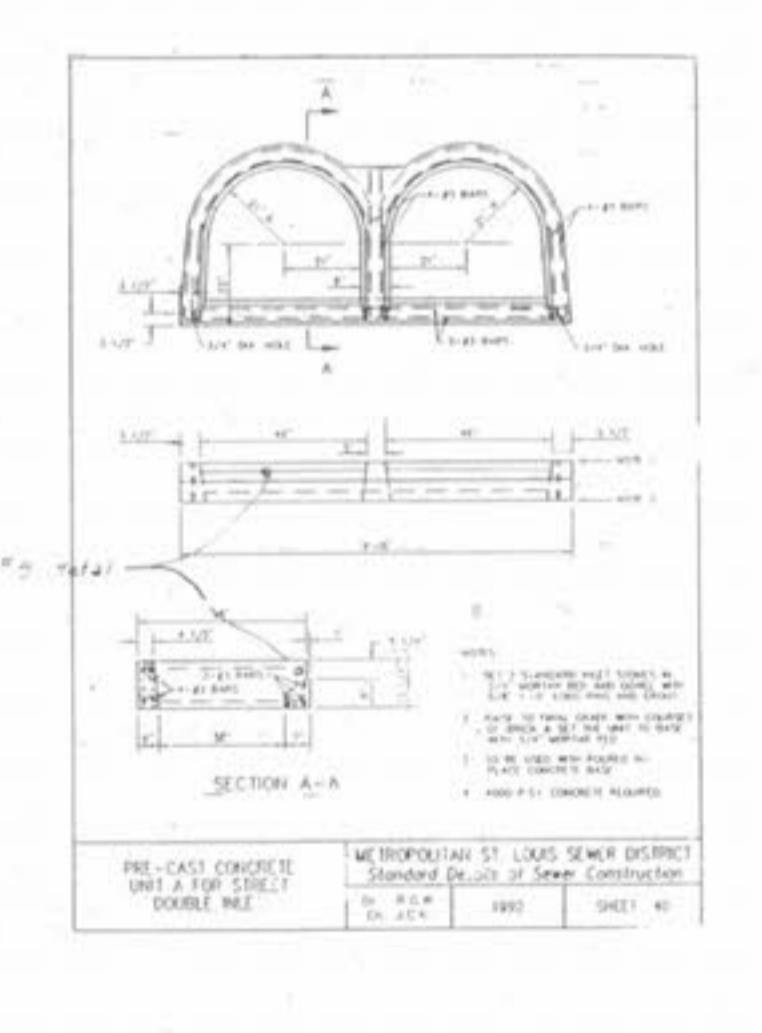
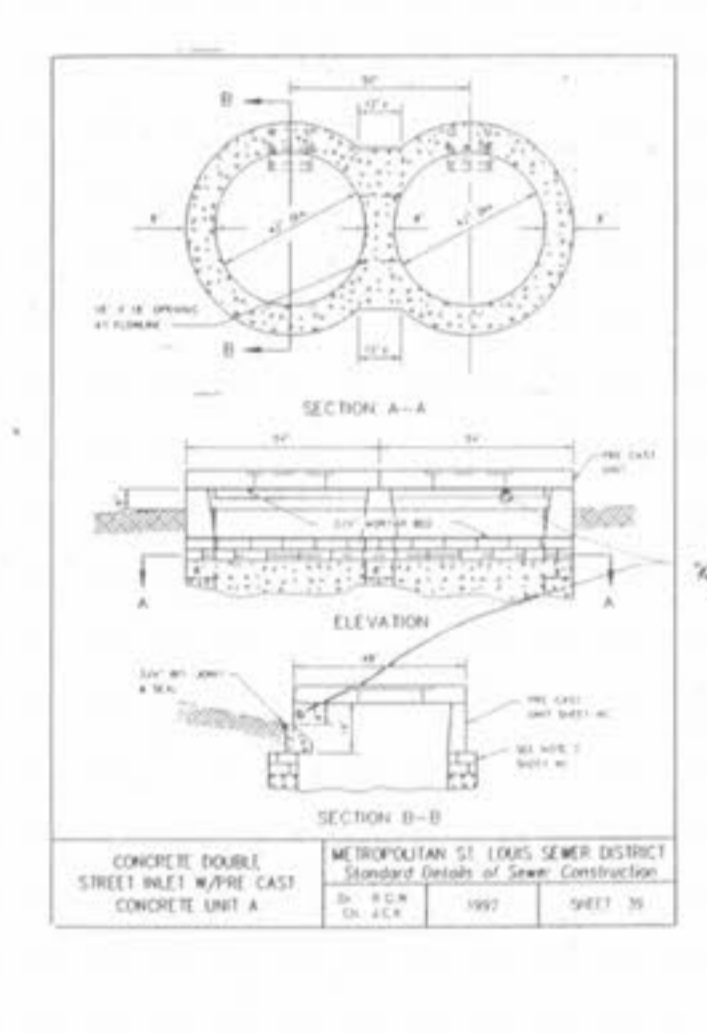
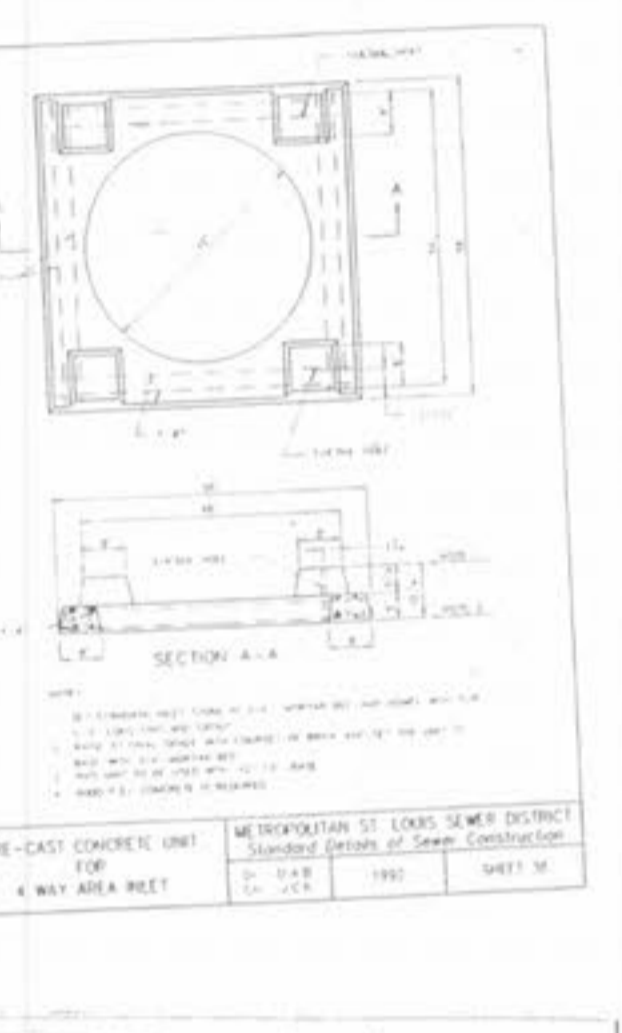
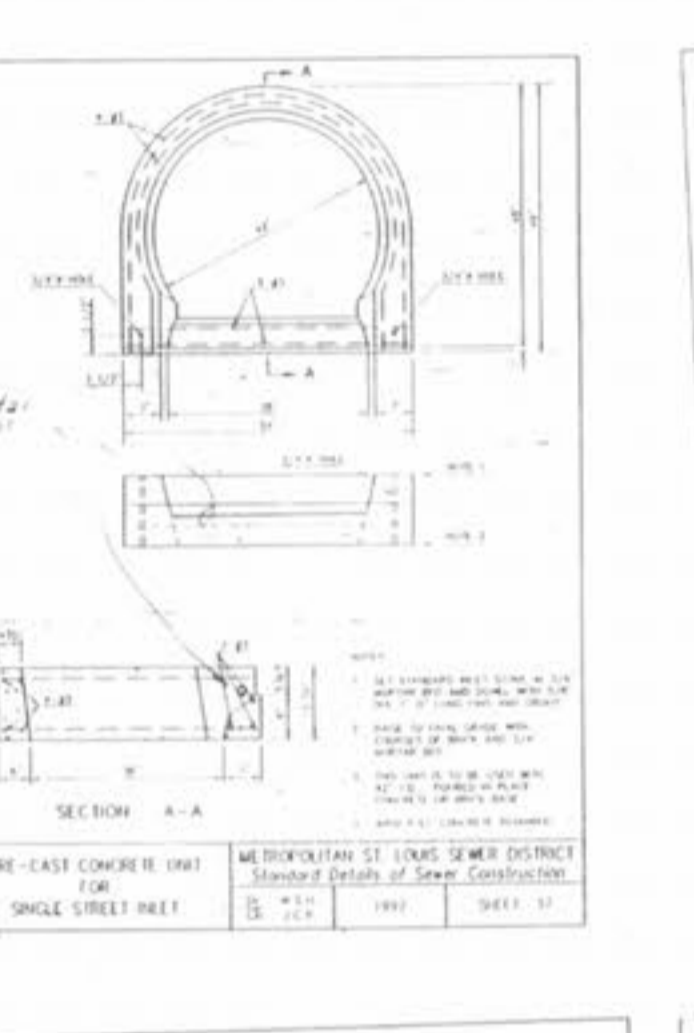
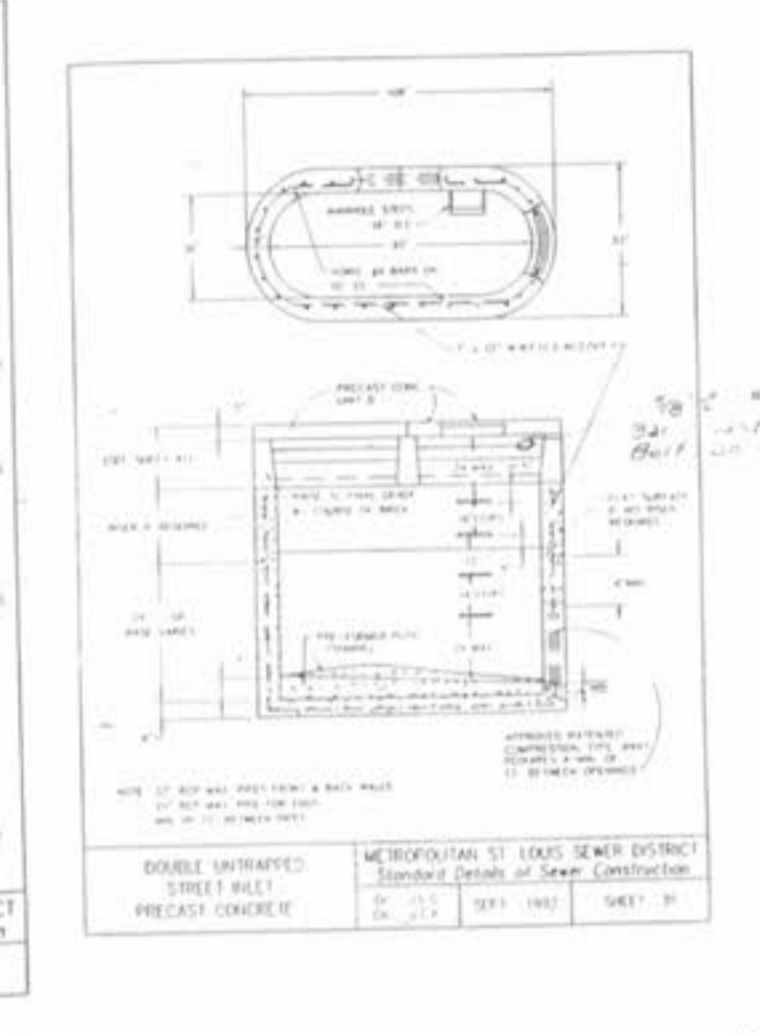
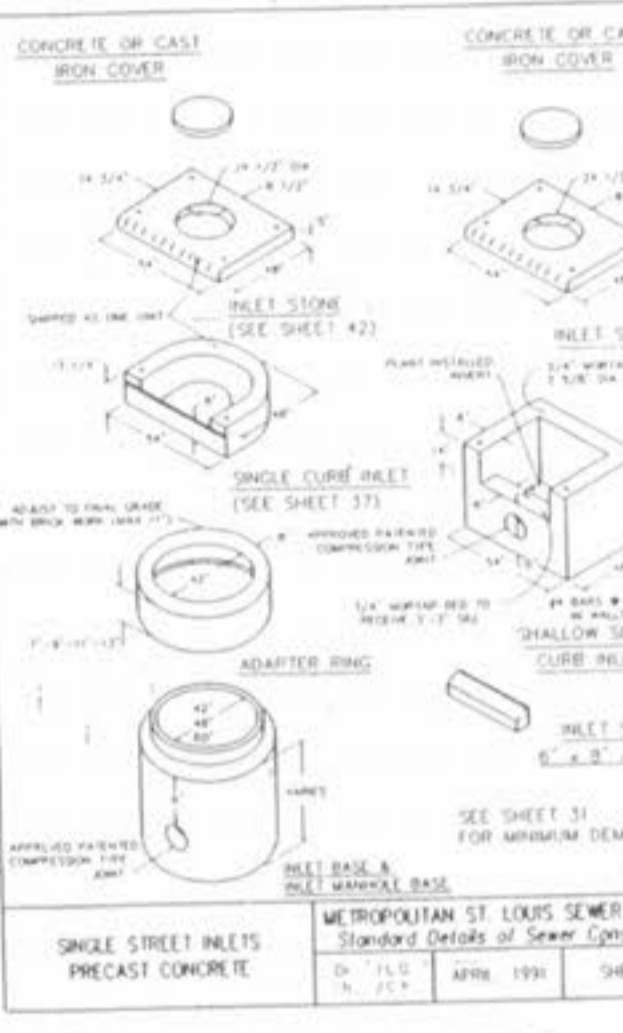
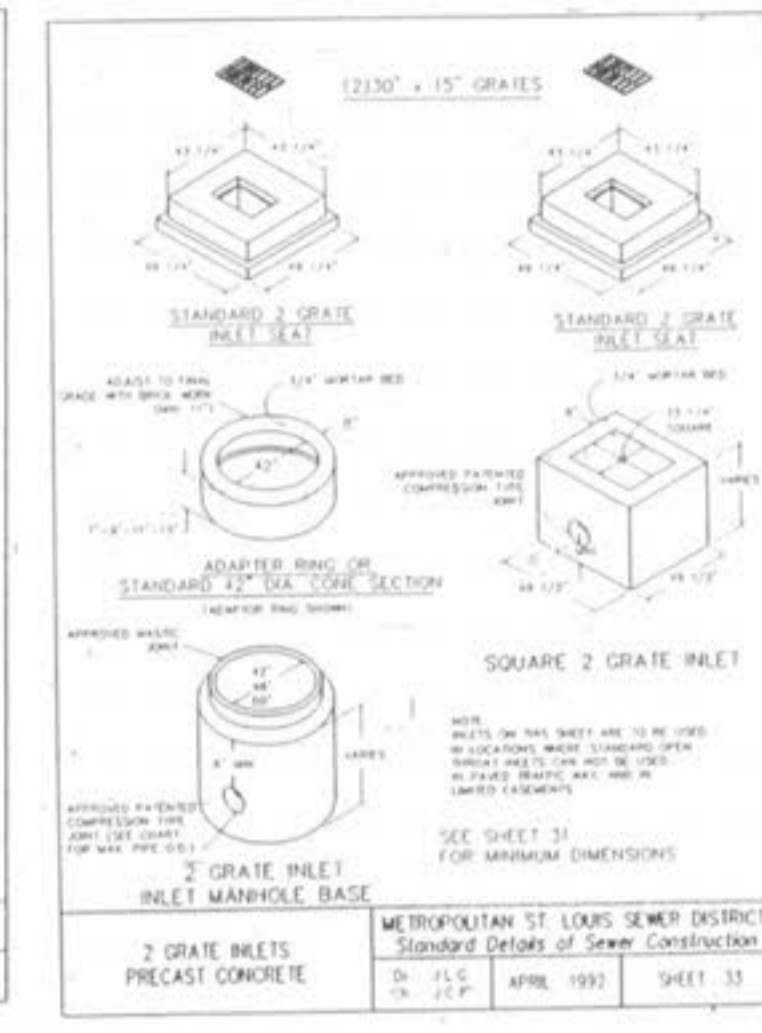
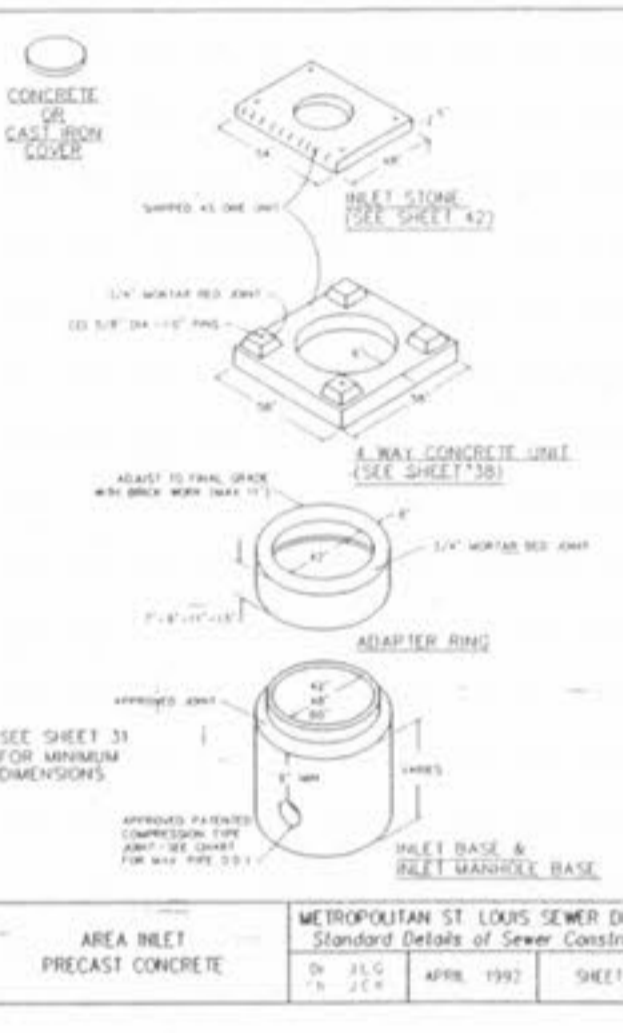
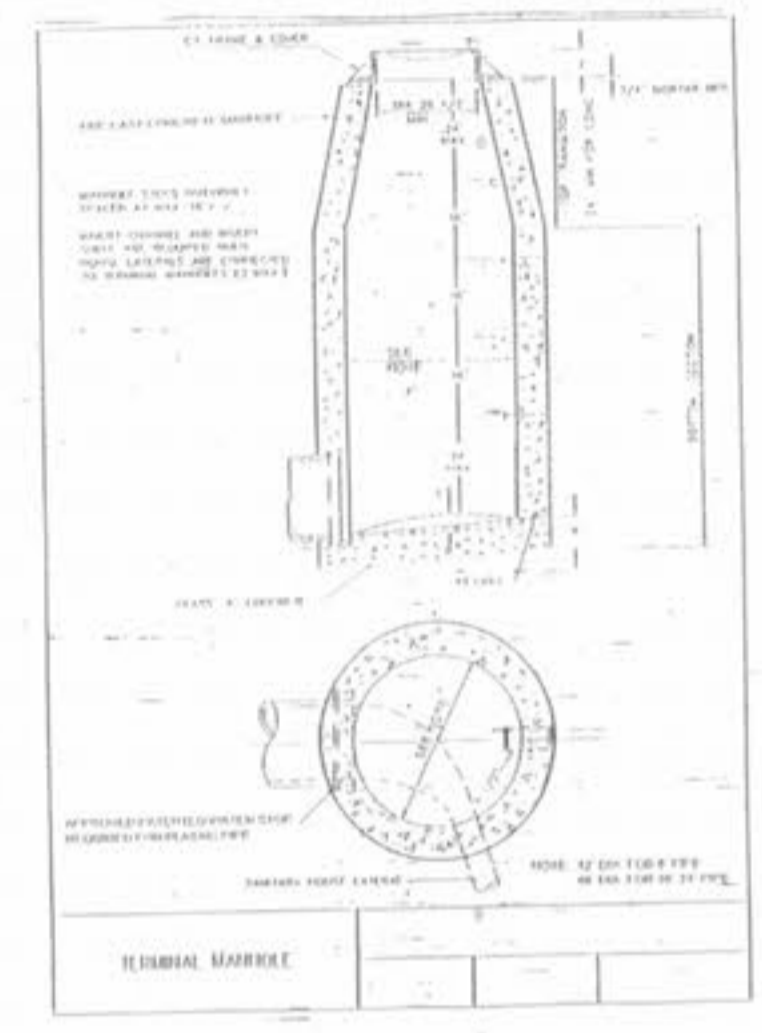
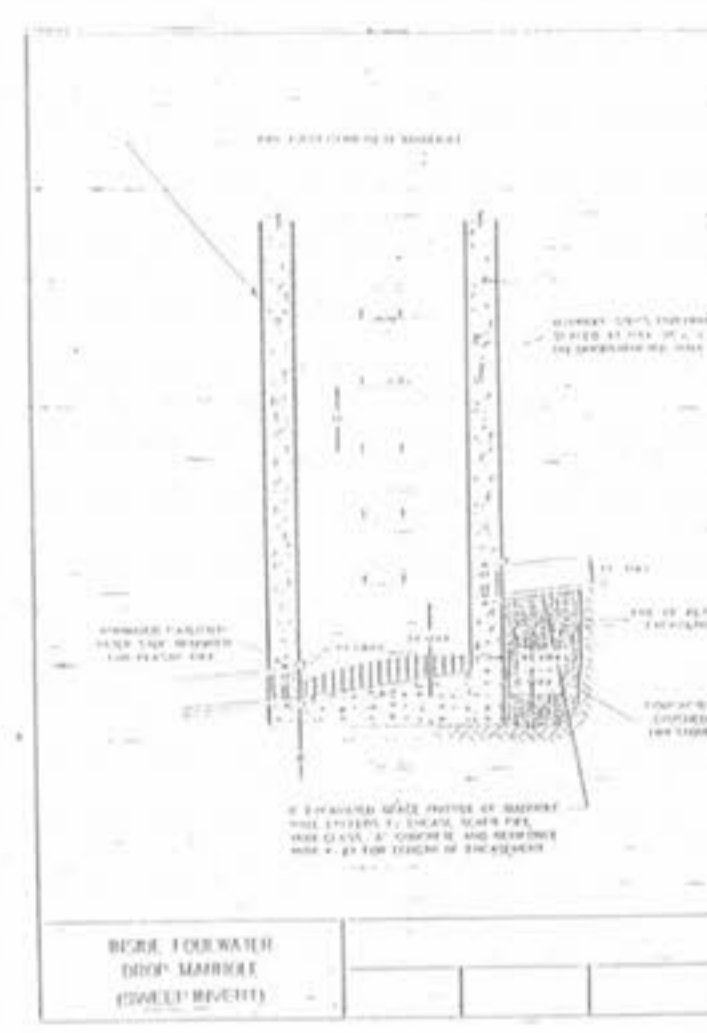
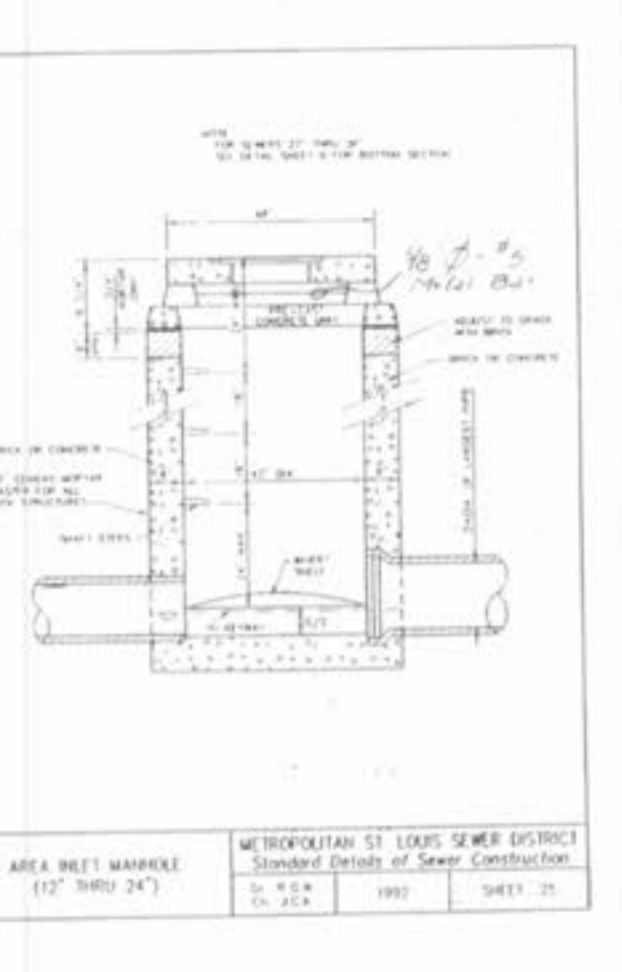
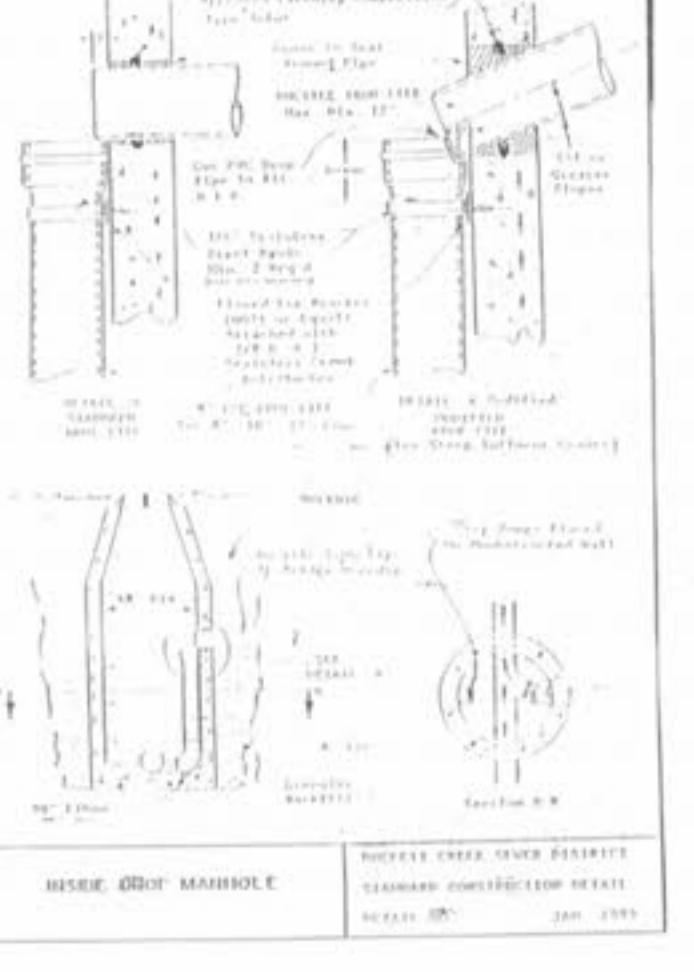
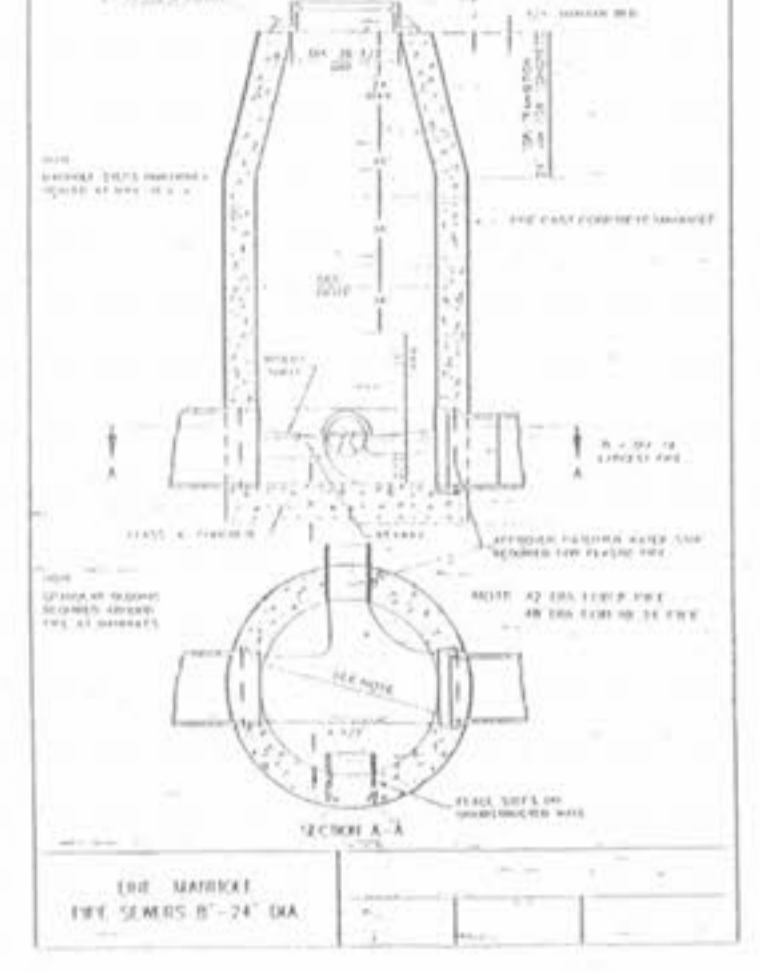
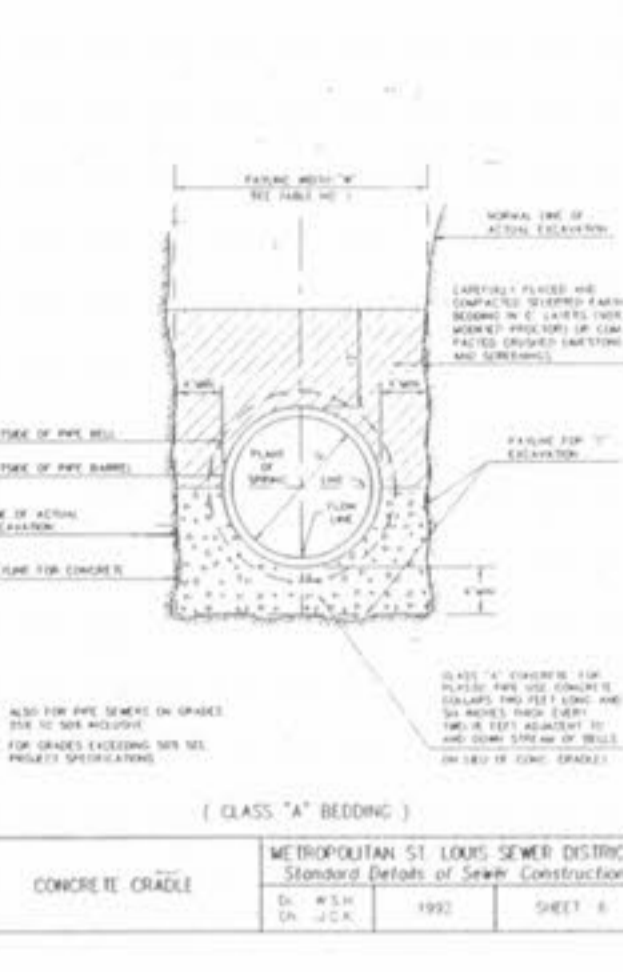
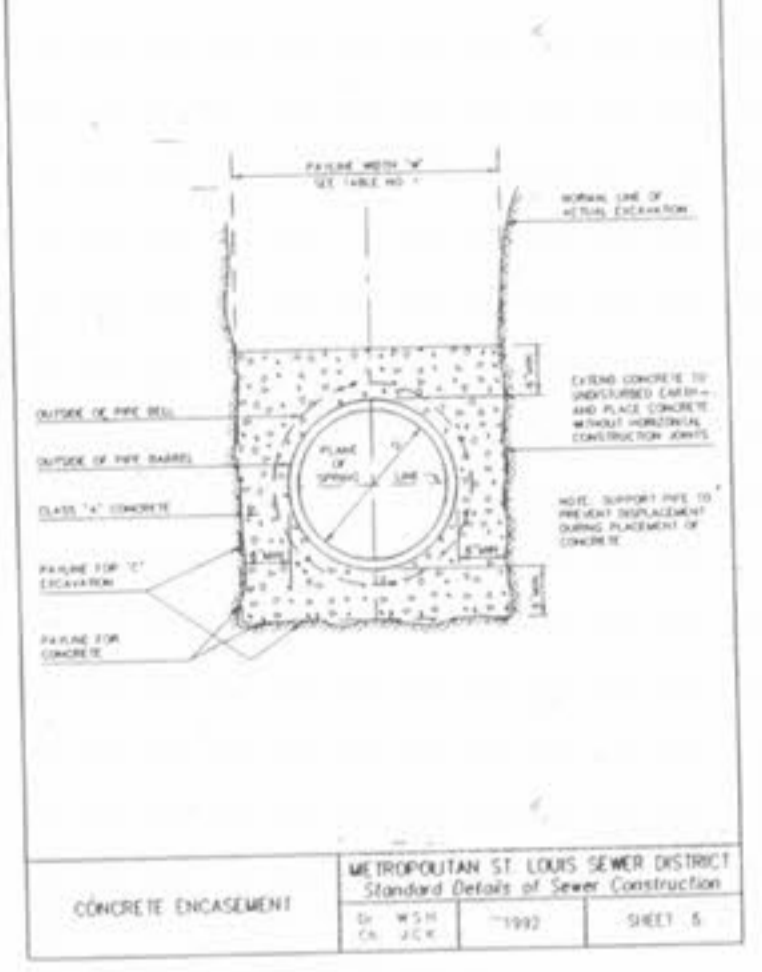
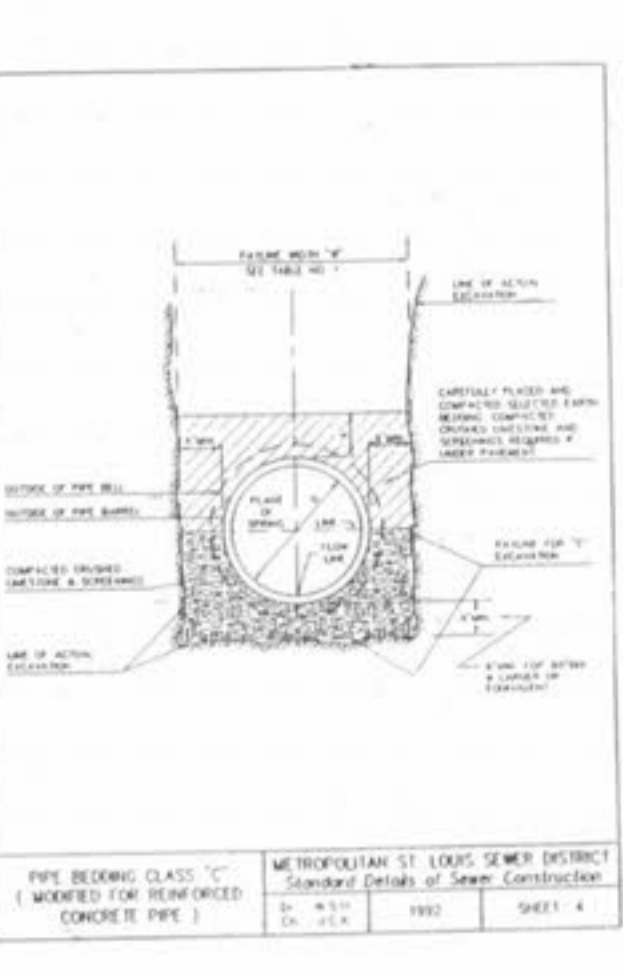
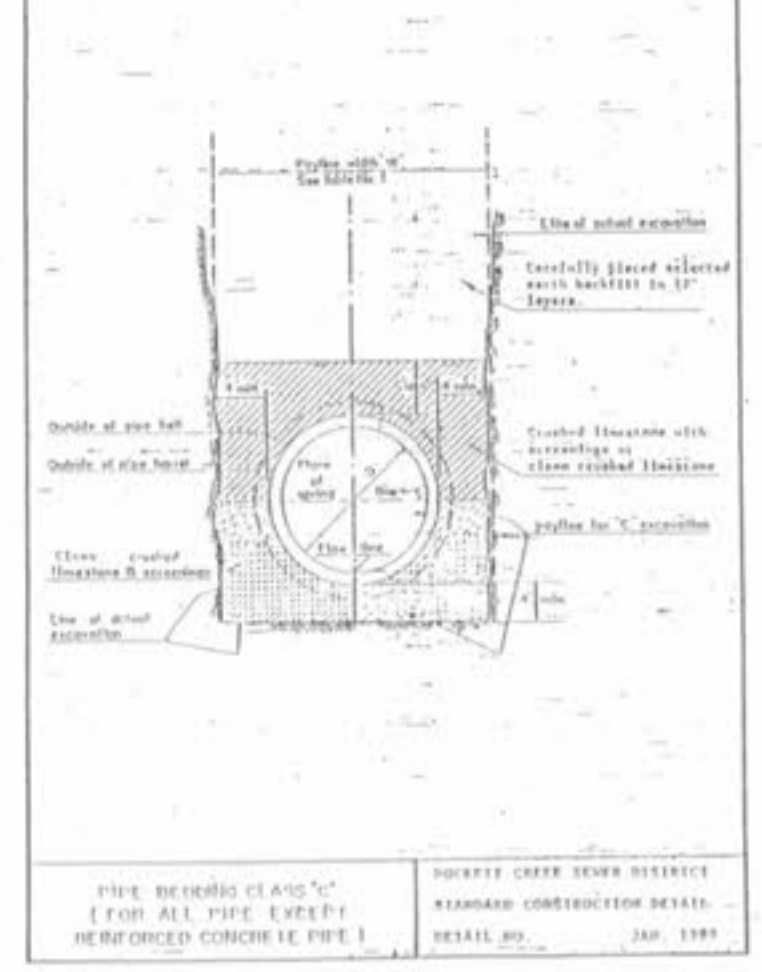

WINGHAVEN
RESIDENTIAL LLC

VOLZ

WINGHAVEN

CONSTRUCTION DETAILS
Design By: R.L.M.
Drawn By: M.E.K.
Checked By: E.A.K.
B-5500
6-28-99
16