

ROUND PIPE		HORIZONTAL ELLIPTICAL PIPE	
PIPE DIAMETER (INCHES)	PIPE WEIGHT (LBS PER FOOT)	PIPE DIAMETER (INCHES)	PIPE WEIGHT (LBS PER FOOT)
12	1.50	12	1.50
14	1.75	14	1.75
16	2.00	16	2.00
18	2.25	18	2.25
20	2.50	20	2.50
22	2.75	22	2.75
24	3.00	24	3.00
26	3.25	26	3.25
28	3.50	28	3.50
30	3.75	30	3.75
32	4.00	32	4.00
34	4.25	34	4.25
36	4.50	36	4.50
38	4.75	38	4.75
40	5.00	40	5.00
42	5.25	42	5.25
44	5.50	44	5.50
46	5.75	46	5.75
48	6.00	48	6.00
50	6.25	50	6.25
52	6.50	52	6.50
54	6.75	54	6.75
56	7.00	56	7.00
58	7.25	58	7.25
60	7.50	60	7.50
62	7.75	62	7.75
64	8.00	64	8.00
66	8.25	66	8.25
68	8.50	68	8.50
70	8.75	70	8.75
72	9.00	72	9.00
74	9.25	74	9.25
76	9.50	76	9.50
78	9.75	78	9.75
80	10.00	80	10.00
82	10.25	82	10.25
84	10.50	84	10.50
86	10.75	86	10.75
88	11.00	88	11.00
90	11.25	90	11.25
92	11.50	92	11.50
94	11.75	94	11.75
96	12.00	96	12.00
98	12.25	98	12.25
100	12.50	100	12.50

TABLE 1
PAVING WEIGHTS OF VARIOUS
AND PAVEMENTS OF CONCRETE

METROPOLITAN ST. LOUIS SEWER DISTRICT
Standard Details of Sewer Construction
D. W. H. & S. J. 1992 SHEET 1

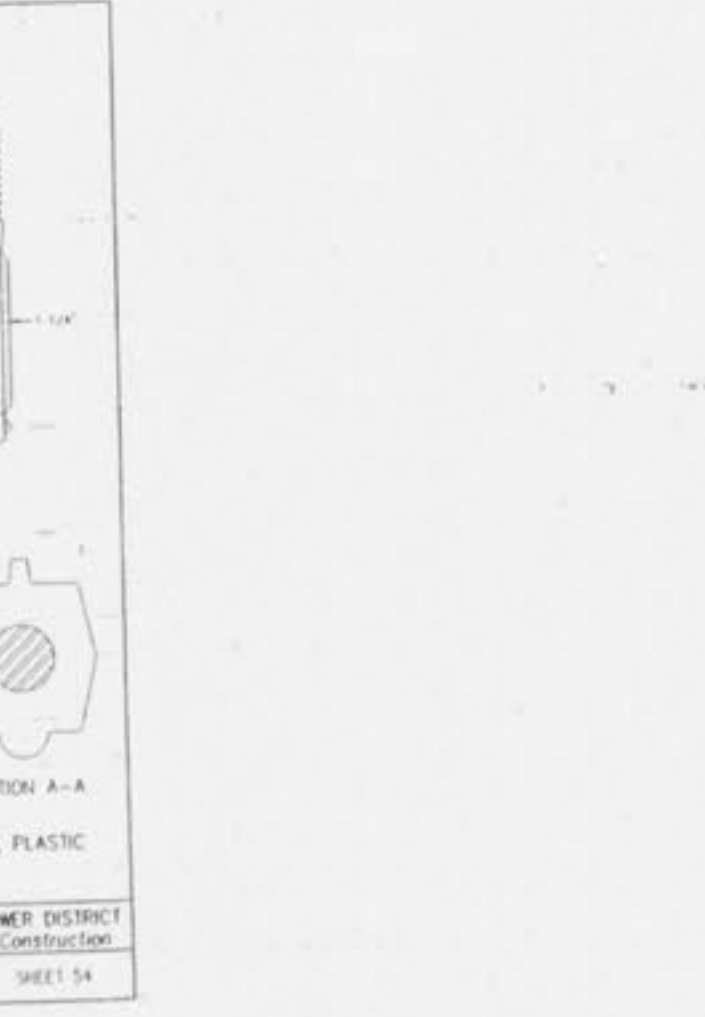
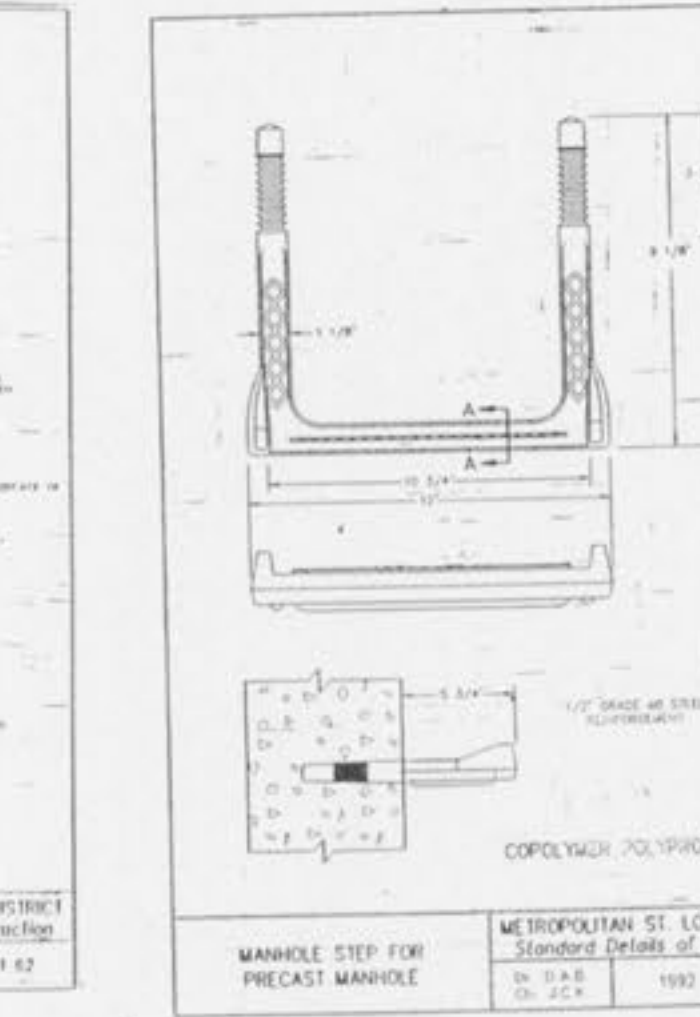
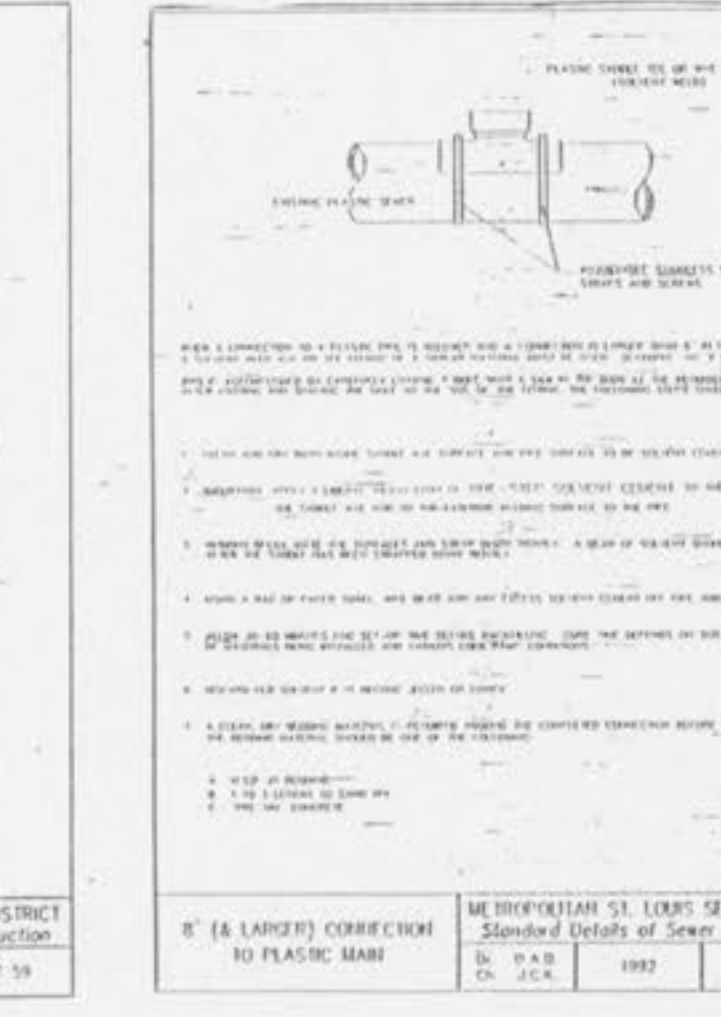
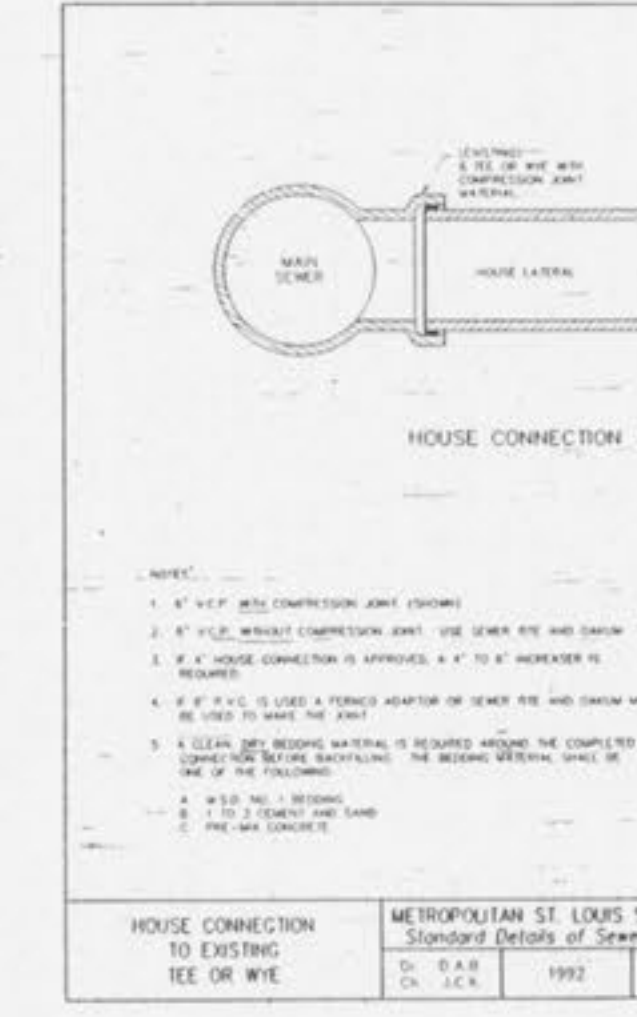
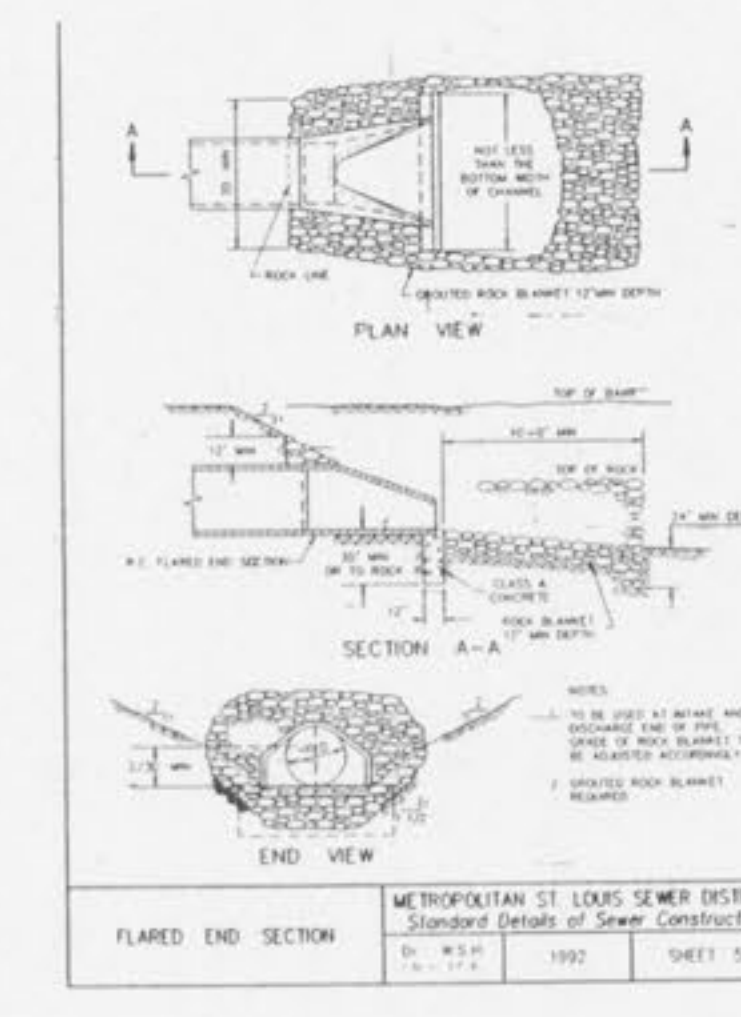
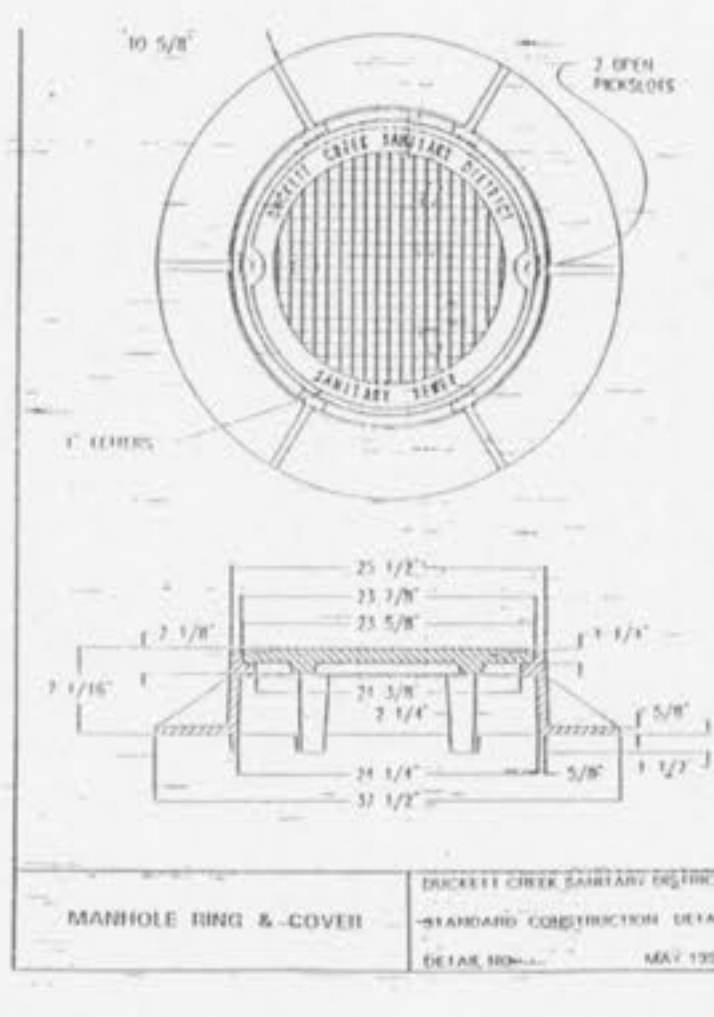
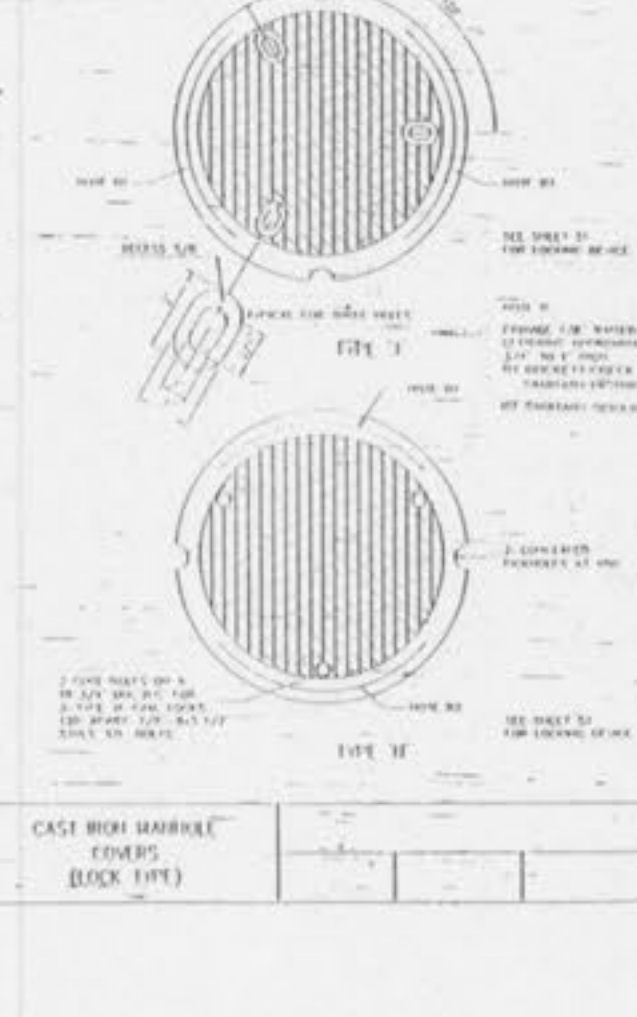
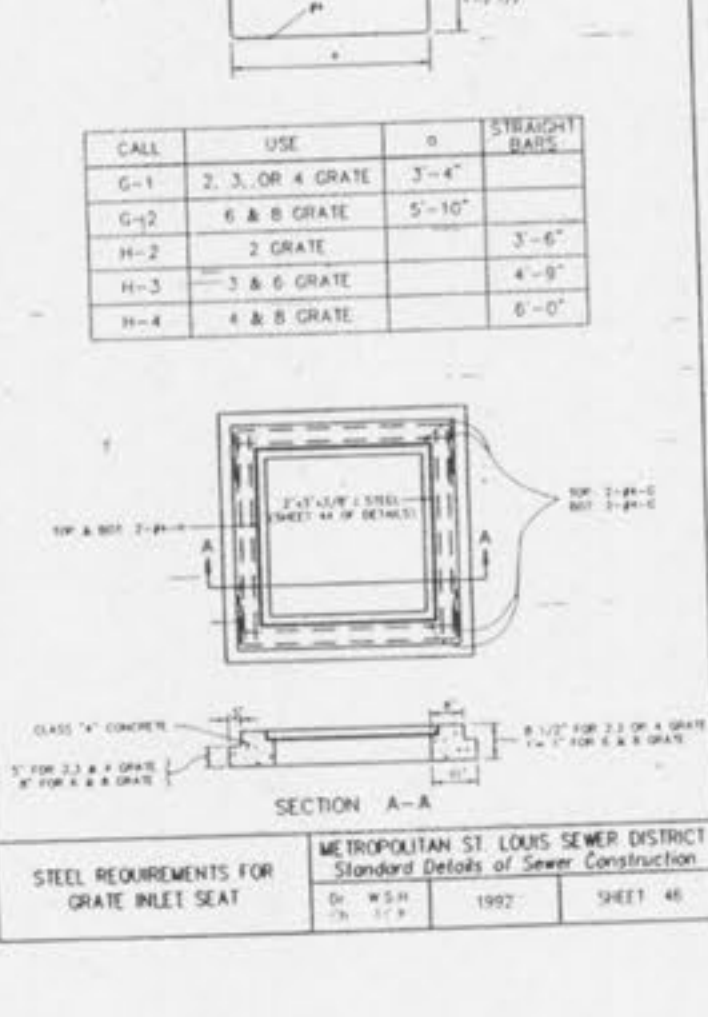
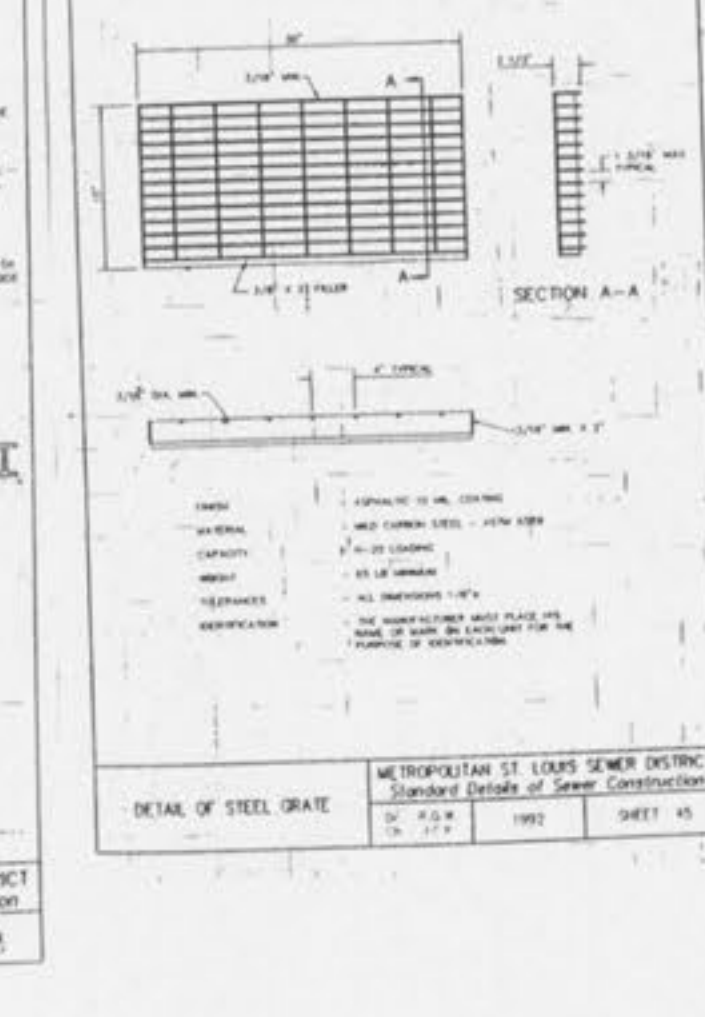
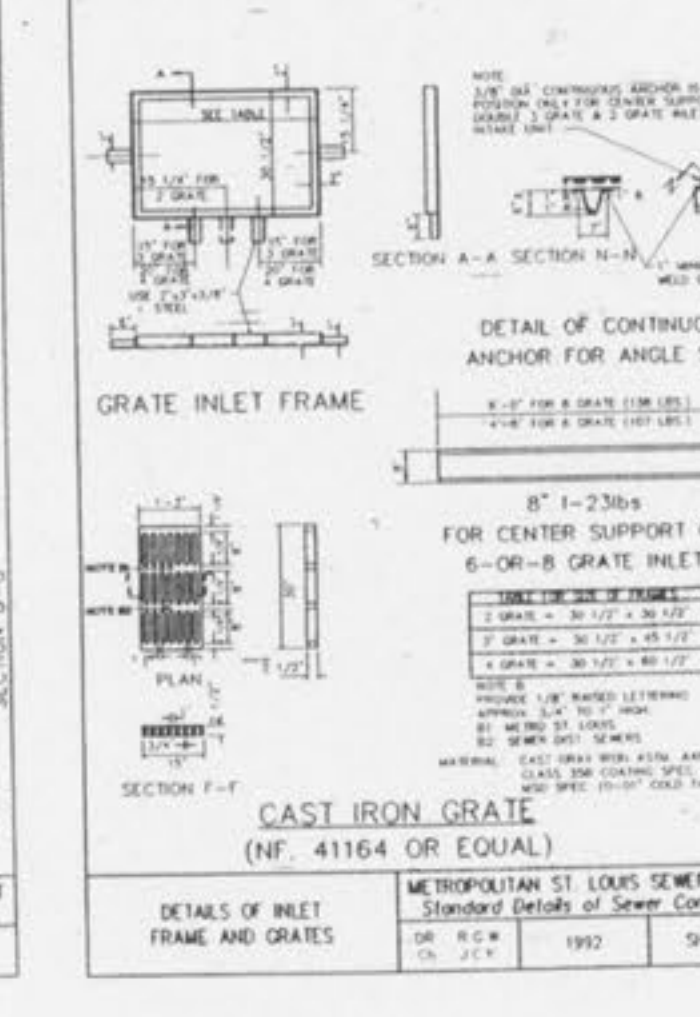
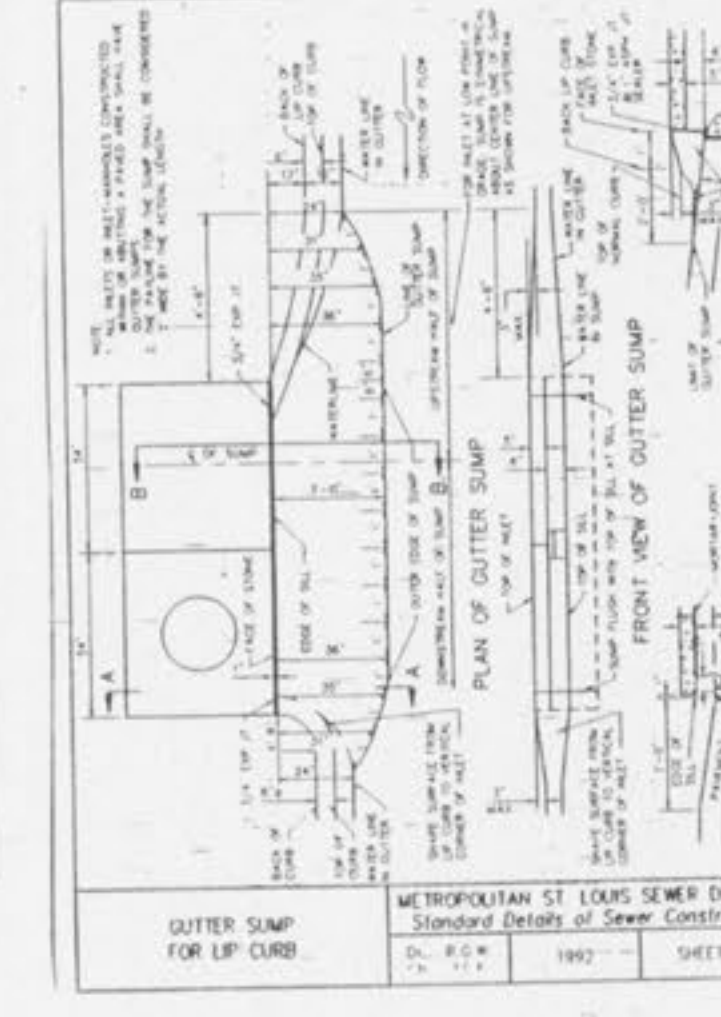
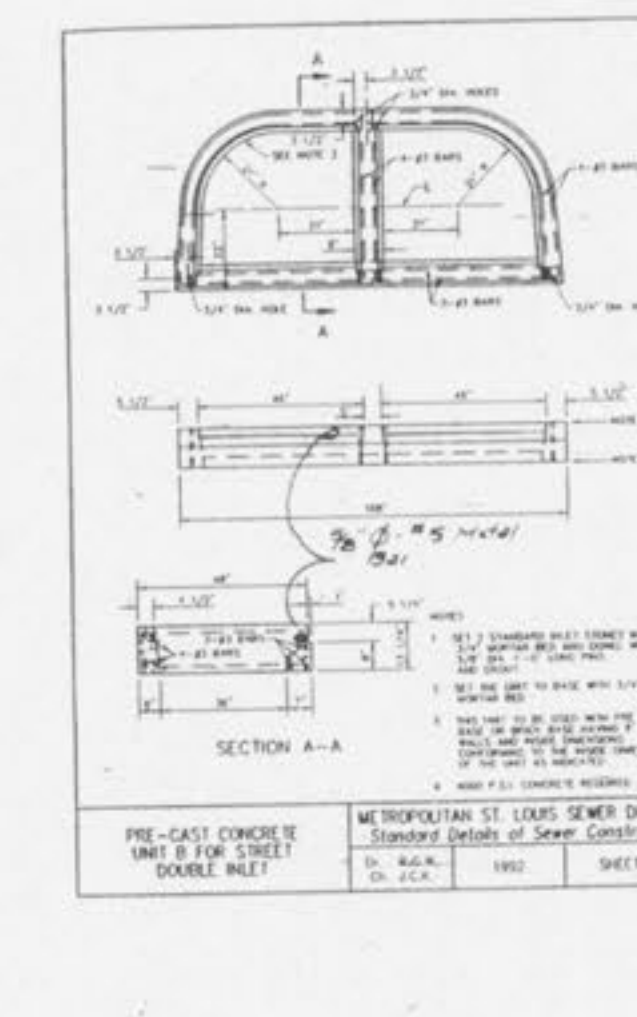
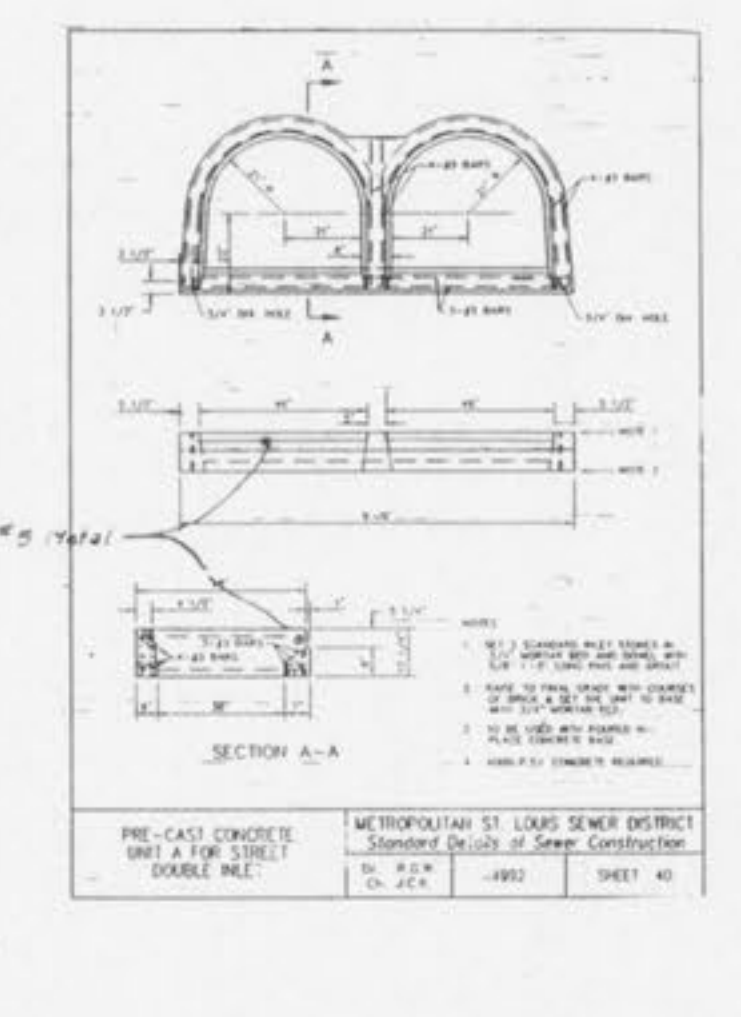
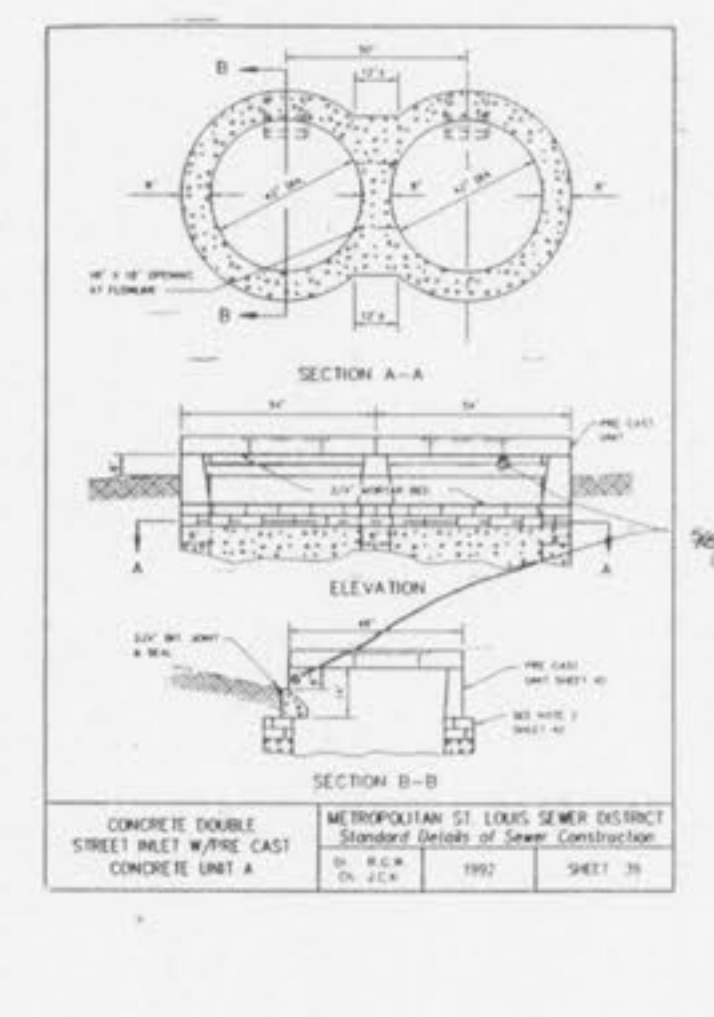
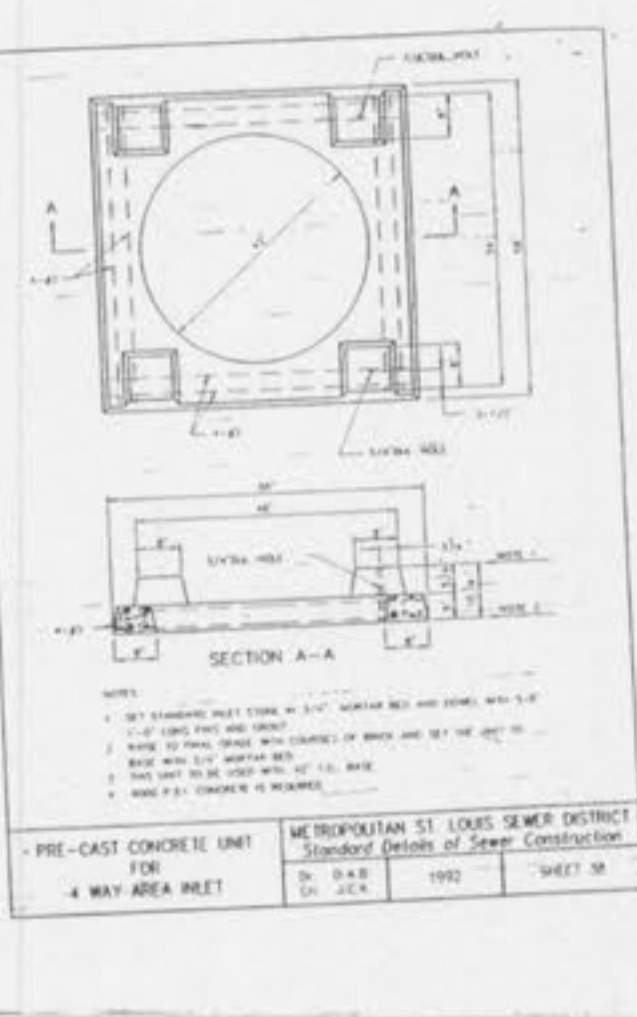
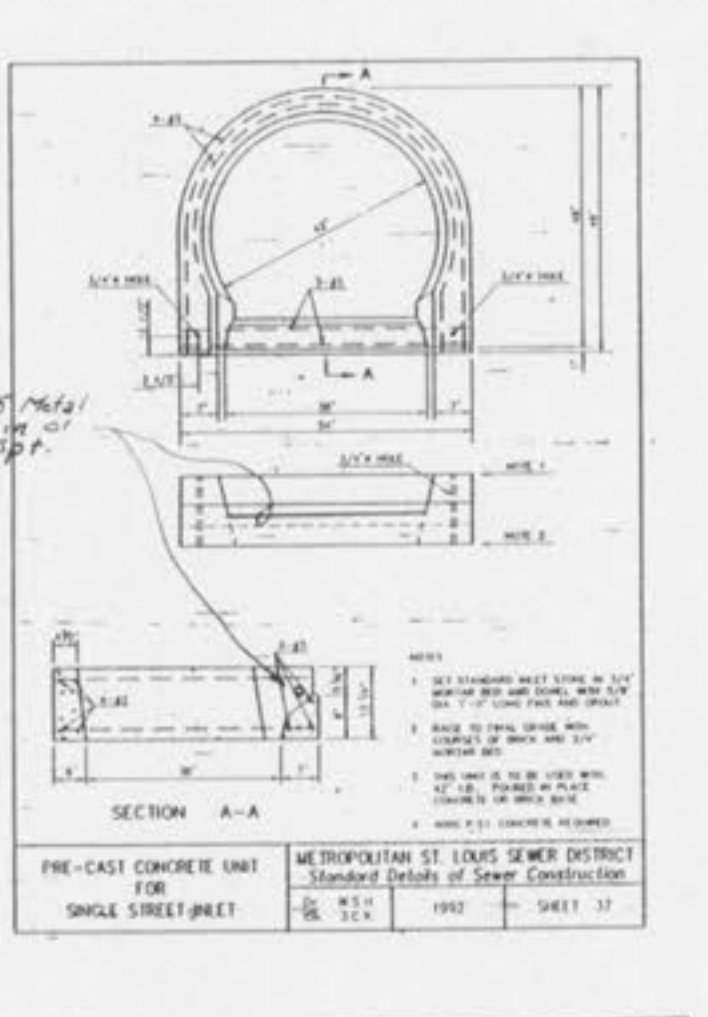
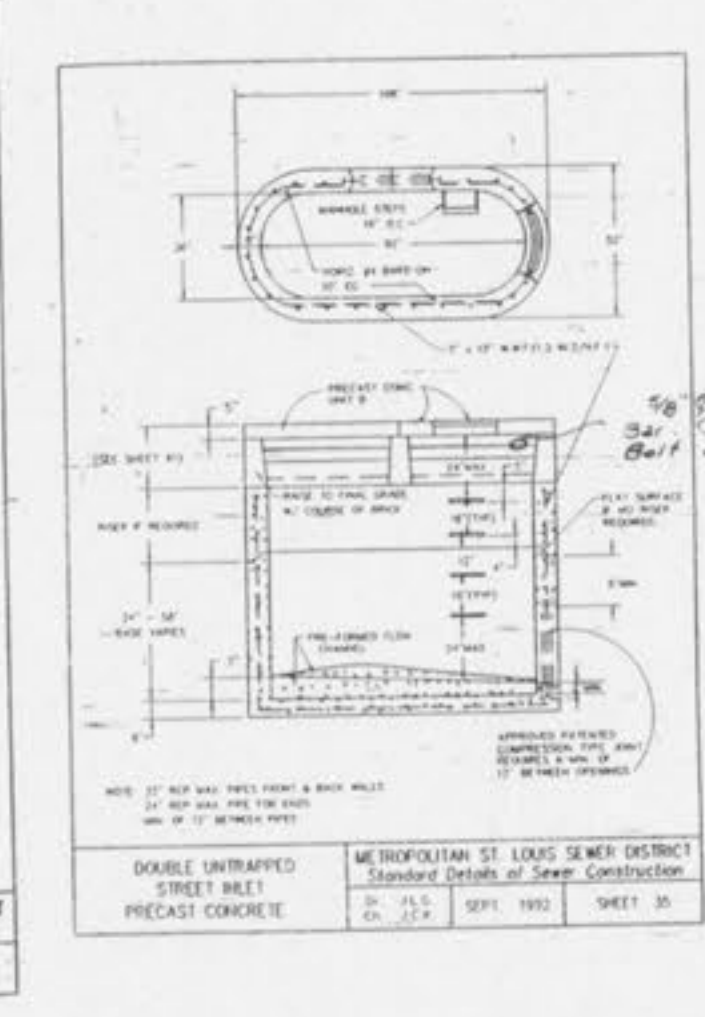
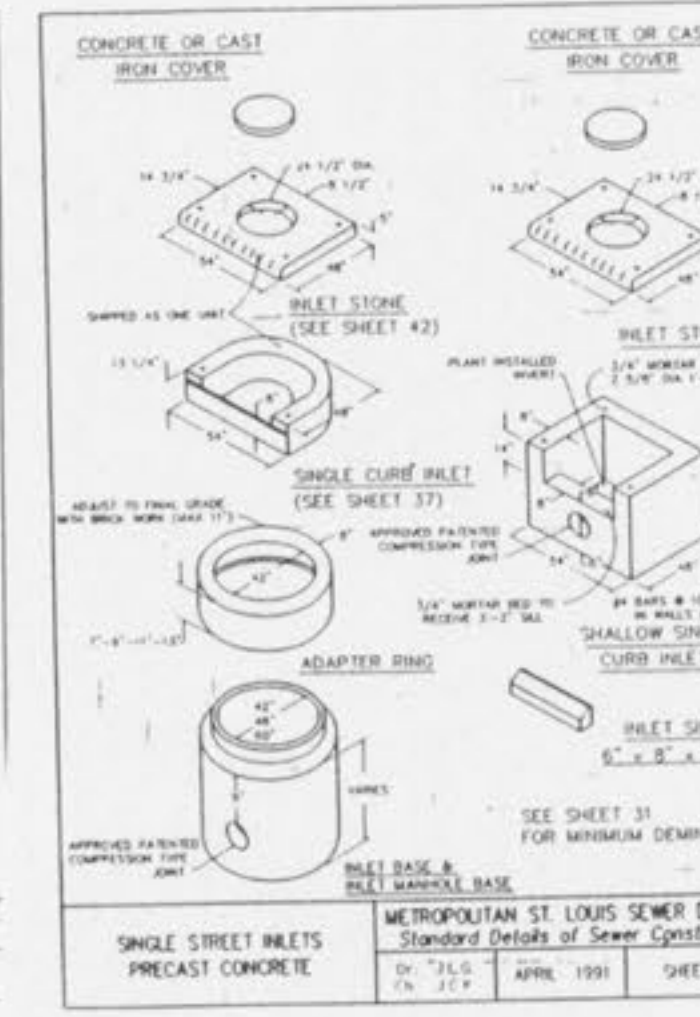
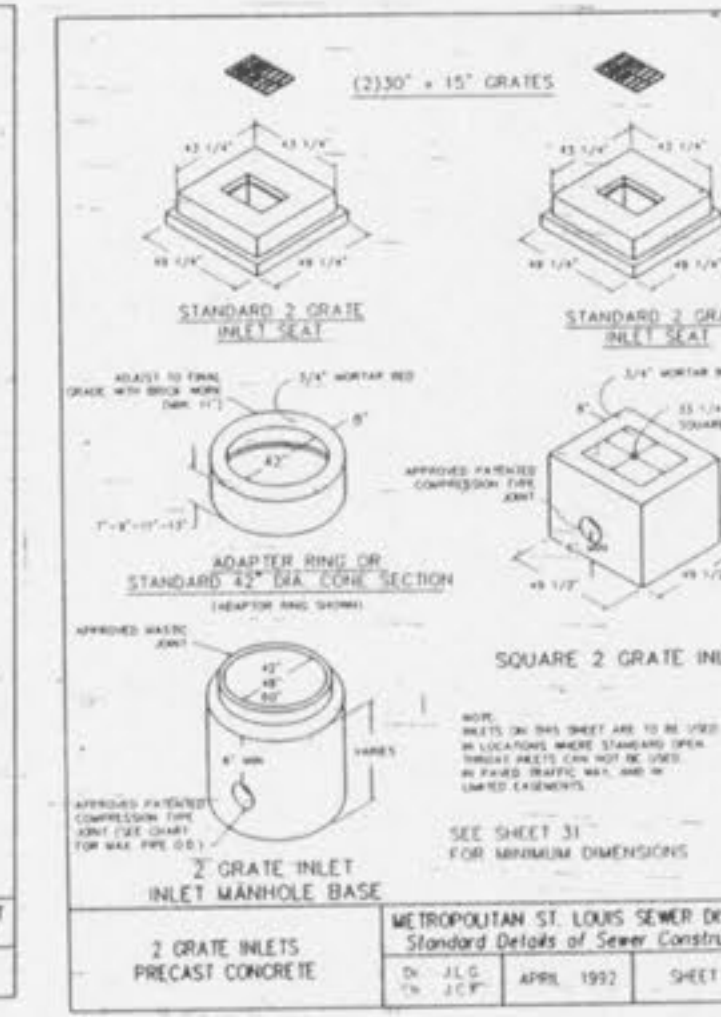
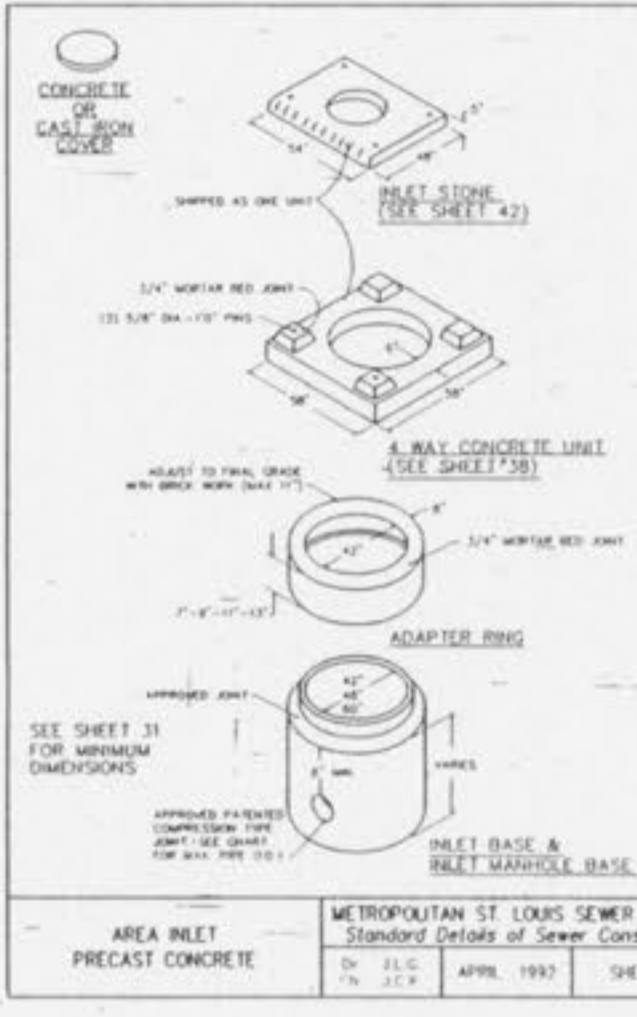
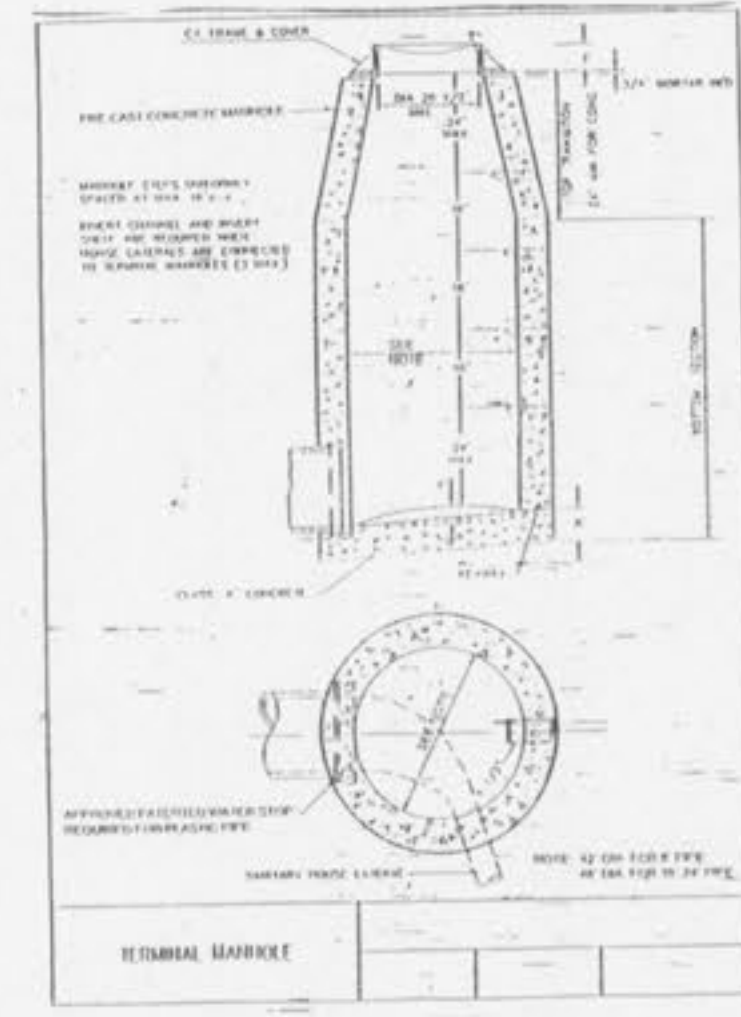
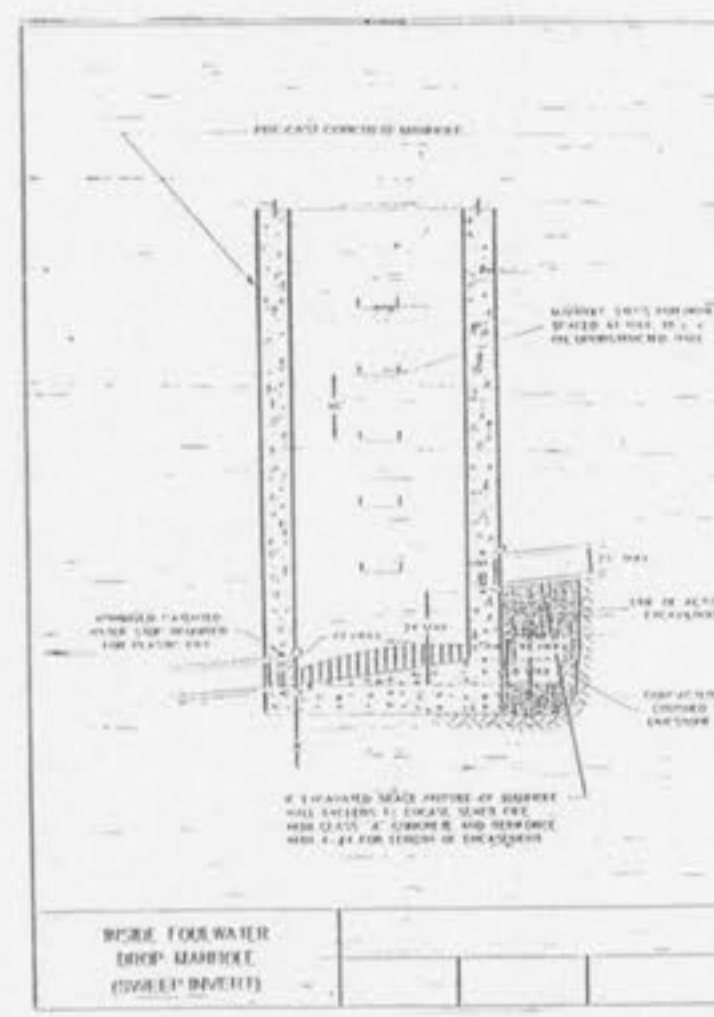
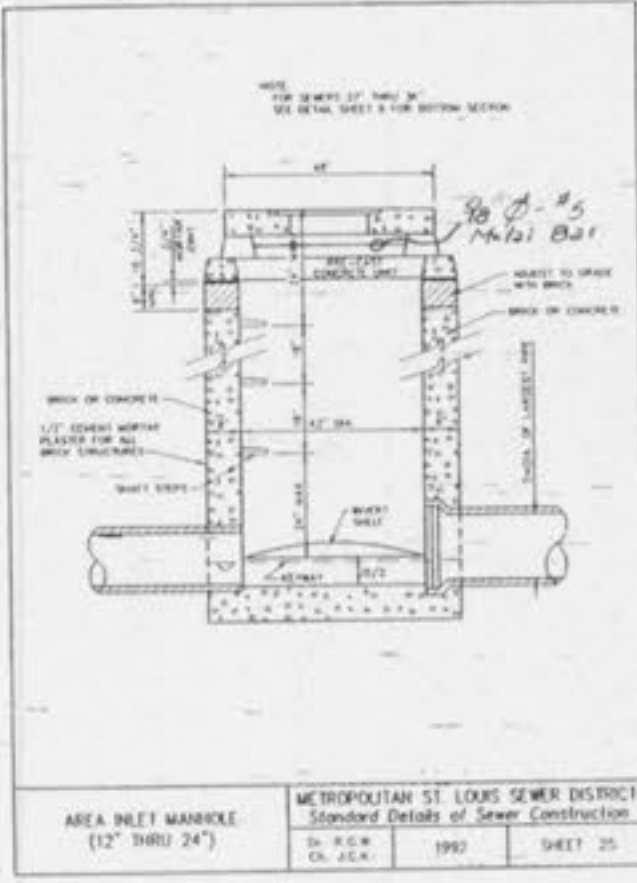
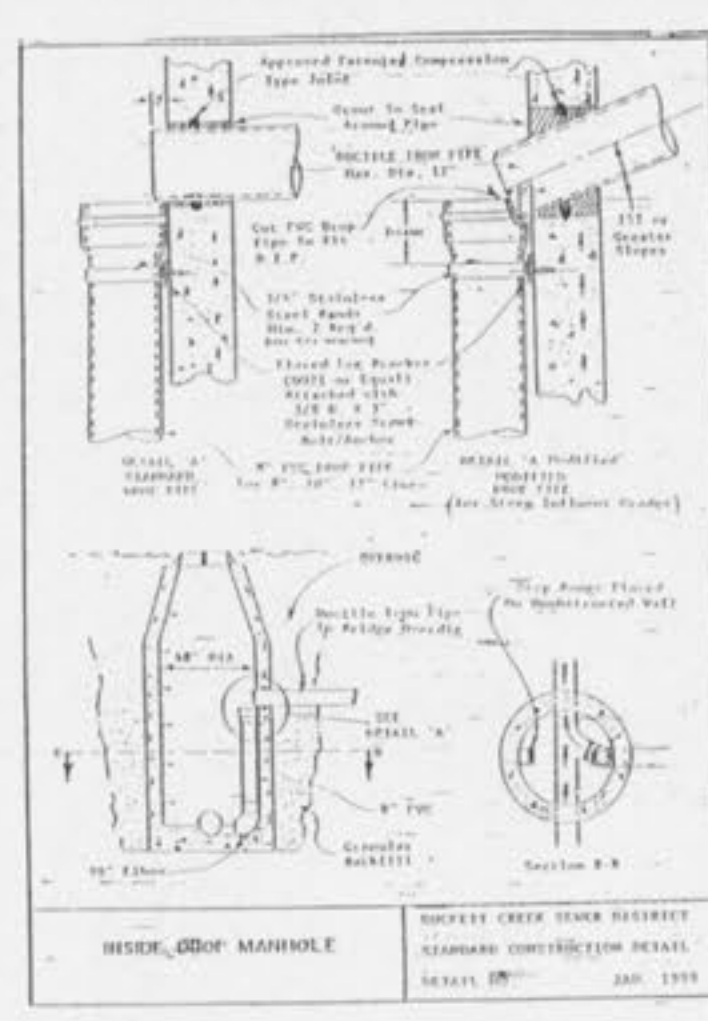
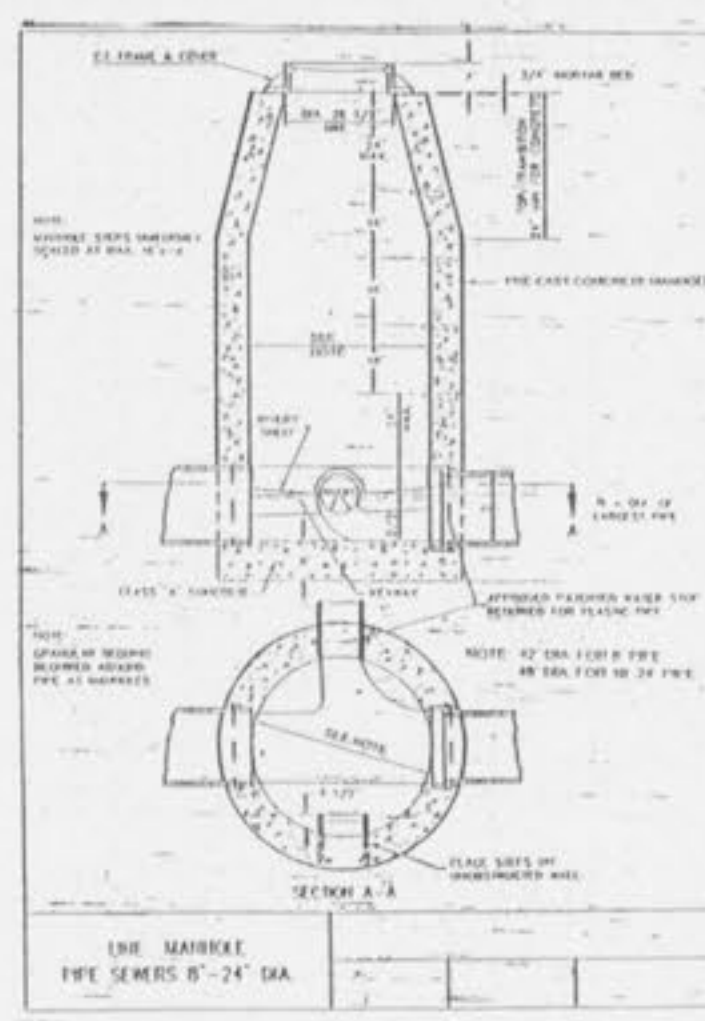
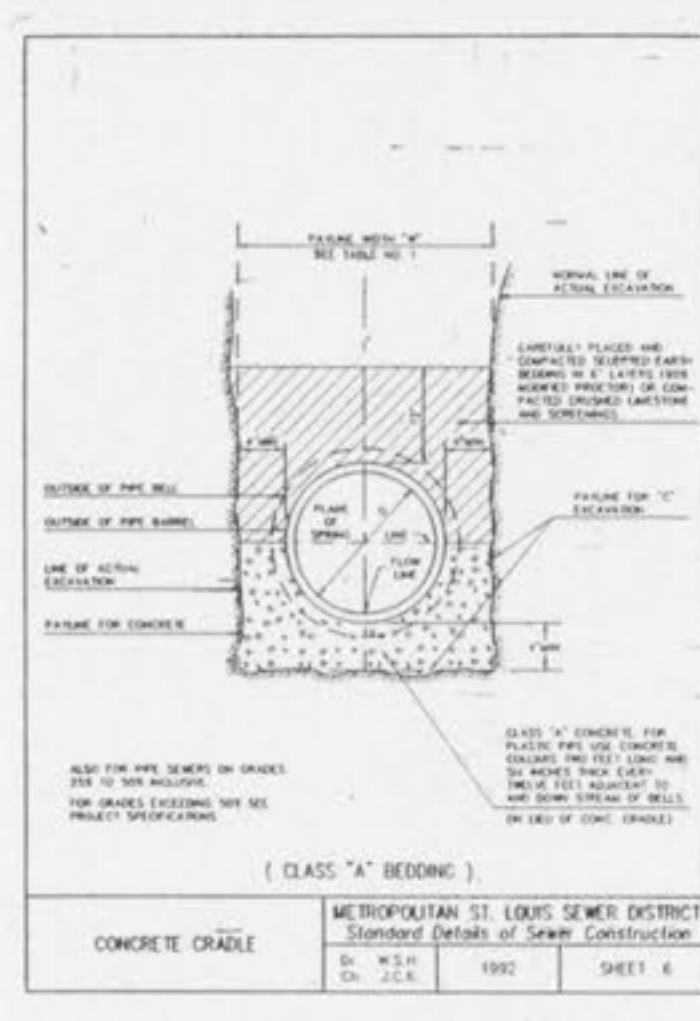
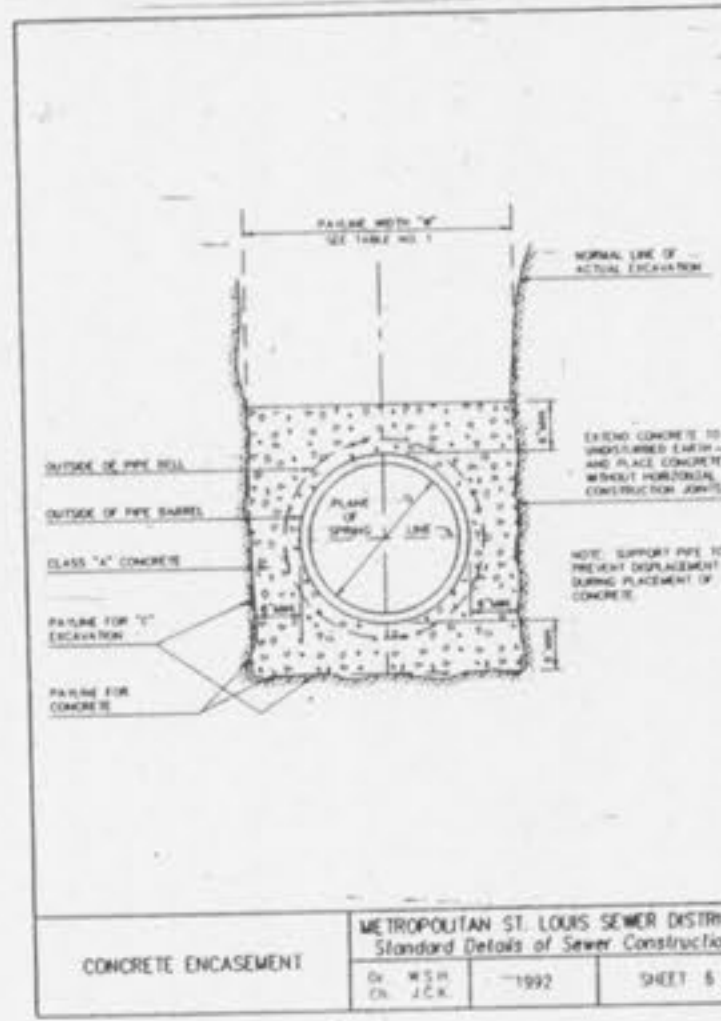
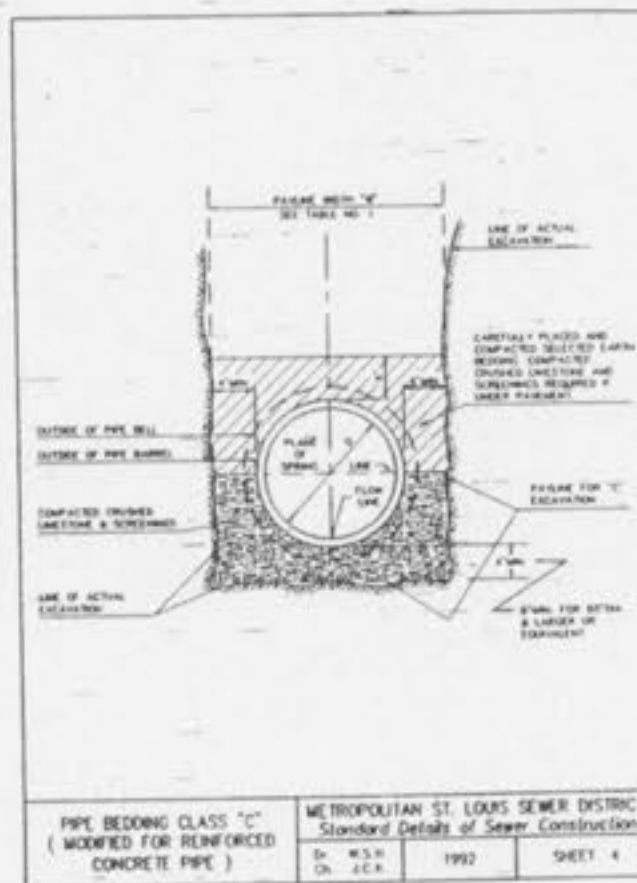
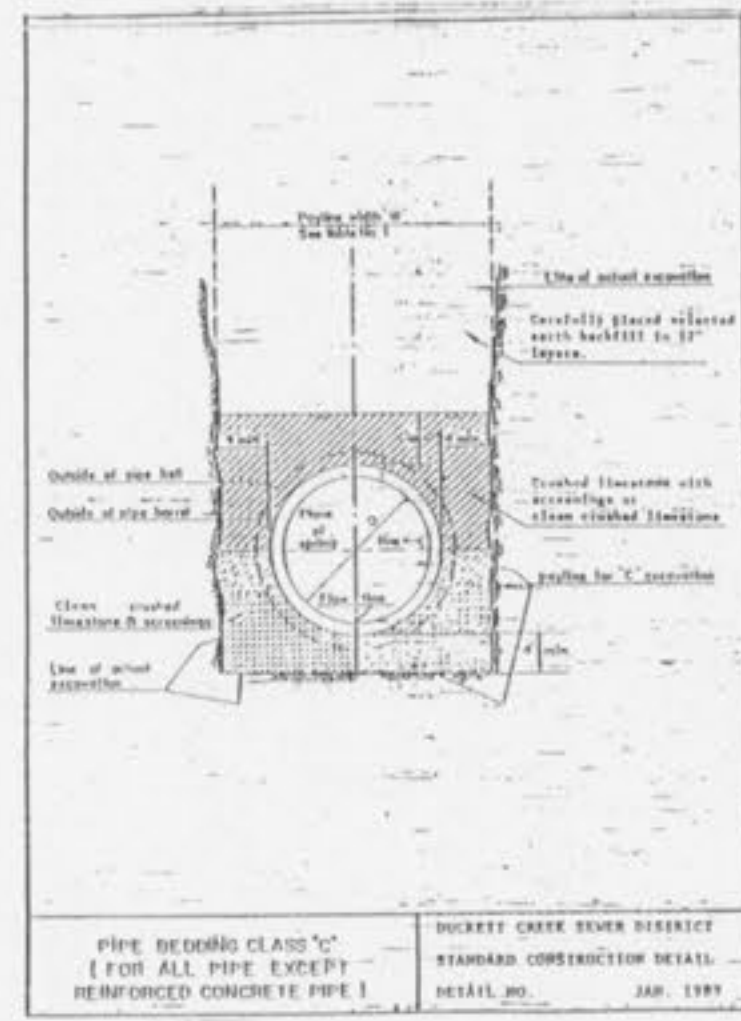

WINGHAVEN
RESIDENTIAL L.L.C.
11111 WINGHAVEN DRIVE
CORPORATE CENTER DRIVE
SUITE 100
DALLAS, TEXAS 75243
PHONE (214) 537-5000



CONSTRUCTION DETAILS
Design By: B.L.M.
Drawn By: M.E.K.
Checked By: E.A.K.

WINGHAVEN

CONSTRUCTION DETAILS
Design By: B.L.M.
Drawn By: M.E.K.
Checked By: E.A.K.