

ROUND PIPE		HORIZONTAL ELLIPTICAL PIPE	
DIAMETER (INCHES)	WEIGHT (LBS. PER FT.)	DIAMETER (INCHES)	WEIGHT (LBS. PER FT.)
4	3.30	12	10.50
6	5.10	18	15.75
8	6.90	24	21.00
10	8.70	30	26.25
12	10.50	36	31.50
14	12.30	42	36.75
16	14.10	48	42.00
18	15.90	54	47.25
20	17.70	60	52.50
22	19.50	66	57.75
24	21.30	72	63.00
26	23.10	78	68.25
28	24.90	84	73.50
30	26.70	90	78.75
32	28.50	96	84.00
34	30.30	102	89.25
36	32.10	108	94.50
38	33.90	114	99.75
40	35.70	120	105.00
42	37.50	126	110.25
44	39.30	132	115.50
46	41.10	138	120.75
48	42.90	144	126.00
50	44.70	150	131.25
52	46.50	156	136.50
54	48.30	162	141.75
56	50.10	168	147.00
58	51.90	174	152.25
60	53.70	180	157.50
62	55.50	186	162.75
64	57.30	192	168.00
66	59.10	198	173.25
68	60.90	204	178.50
70	62.70	210	183.75
72	64.50	216	189.00
74	66.30	222	194.25
76	68.10	228	199.50
78	69.90	234	204.75
80	71.70	240	210.00
82	73.50	246	215.25
84	75.30	252	220.50
86	77.10	258	225.75
88	78.90	264	231.00
90	80.70	270	236.25
92	82.50	276	241.50
94	84.30	282	246.75
96	86.10	288	252.00
98	87.90	294	257.25
100	89.70	300	262.50
102	91.50	306	267.75
104	93.30	312	273.00
106	95.10	318	278.25
108	96.90	324	283.50
110	98.70	330	288.75
112	100.50	336	294.00
114	102.30	342	299.25
116	104.10	348	304.50
118	105.90	354	309.75
120	107.70	360	315.00
122	109.50	366	320.25
124	111.30	372	325.50
126	113.10	378	330.75
128	114.90	384	336.00
130	116.70	390	341.25
132	118.50	396	346.50
134	120.30	402	351.75
136	122.10	408	357.00
138	123.90	414	362.25
140	125.70	420	367.50
142	127.50	426	372.75
144	129.30	432	378.00
146	131.10	438	383.25
148	132.90	444	388.50
150	134.70	450	393.75
152	136.50	456	399.00
154	138.30	462	404.25
156	140.10	468	409.50
158	141.90	474	414.75
160	143.70	480	420.00
162	145.50	486	425.25
164	147.30	492	430.50
166	149.10	498	435.75
168	150.90	504	441.00
170	152.70	510	446.25
172	154.50	516	451.50
174	156.30	522	456.75
176	158.10	528	462.00
178	159.90	534	467.25
180	161.70	540	472.50
182	163.50	546	477.75
184	165.30	552	483.00
186	167.10	558	488.25
188	168.90	564	493.50
190	170.70	570	498.75
192	172.50	576	504.00
194	174.30	582	509.25
196	176.10	588	514.50
198	177.90	594	519.75
200	179.70	600	525.00

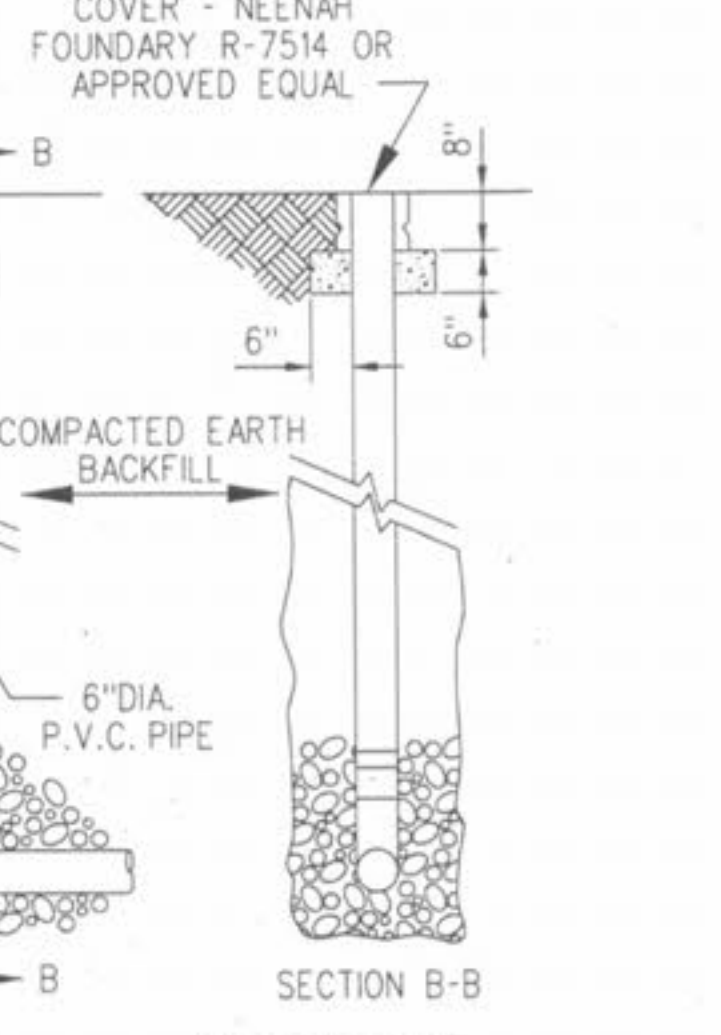
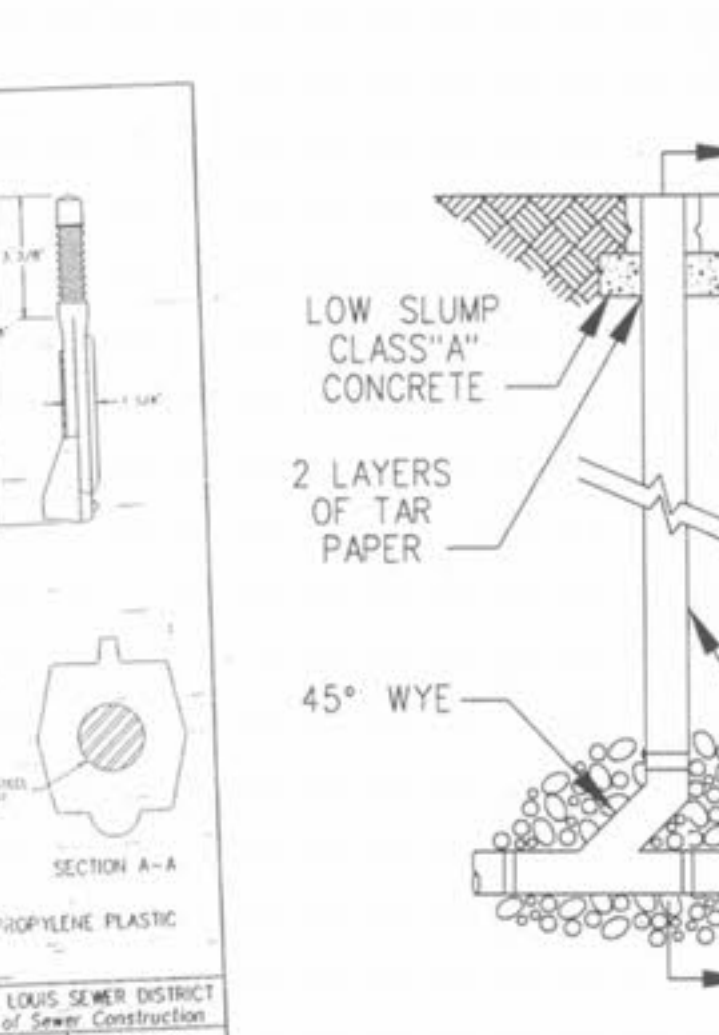
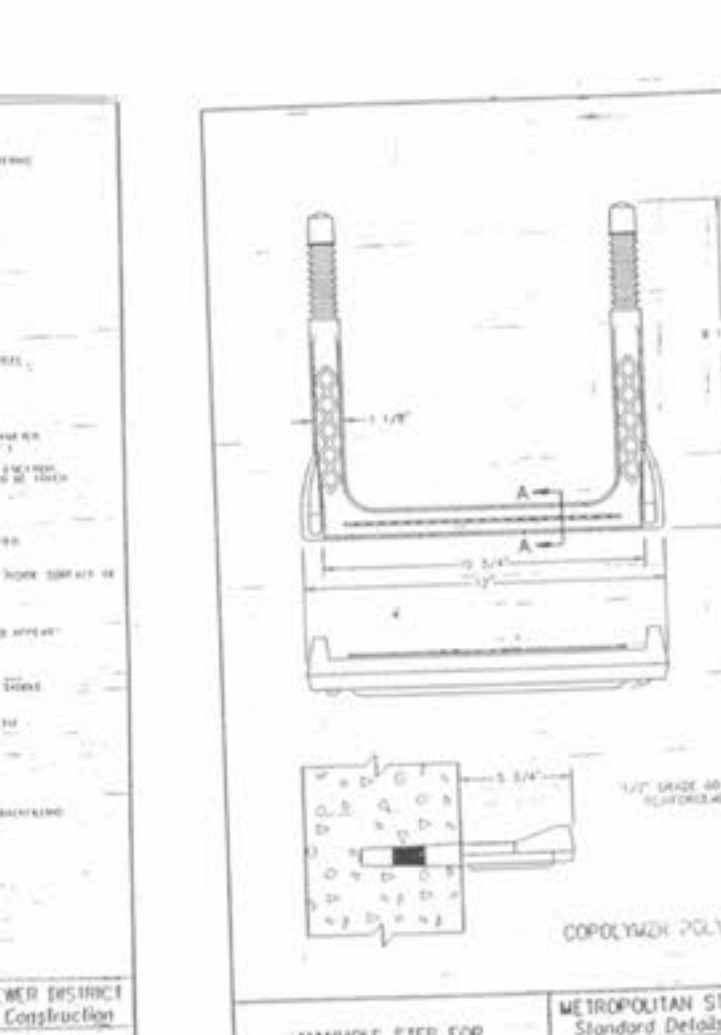
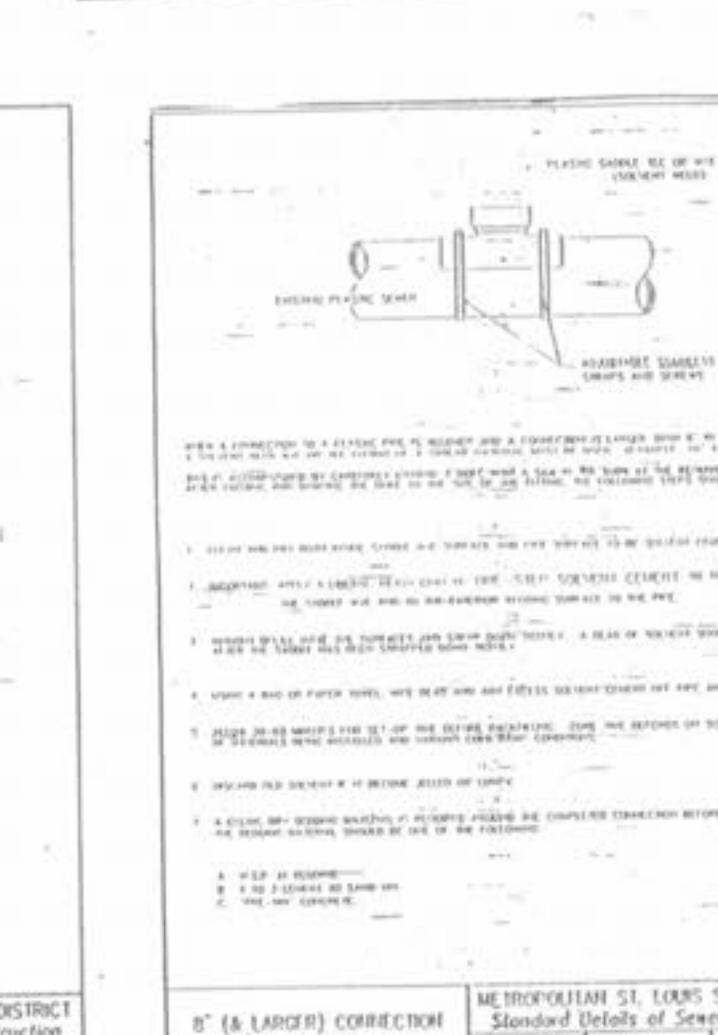
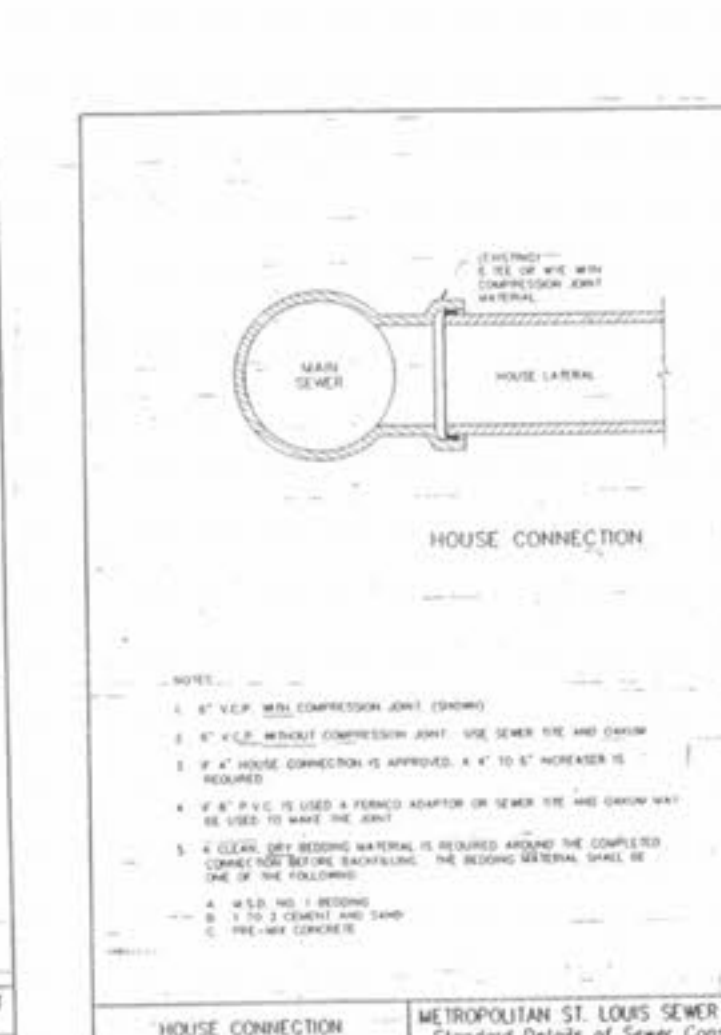
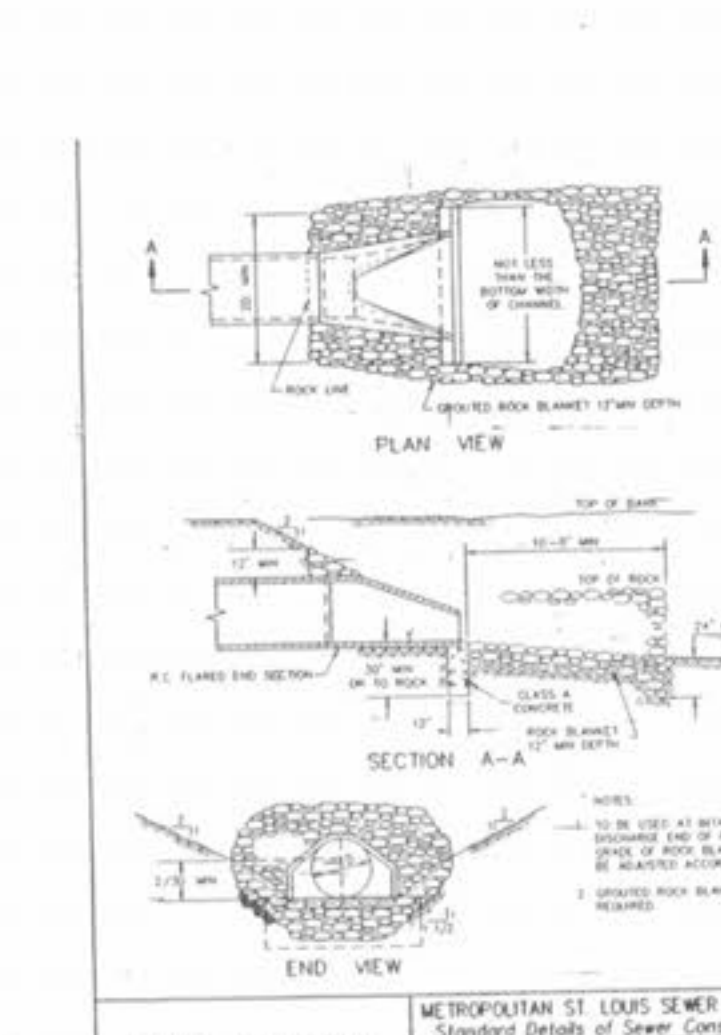
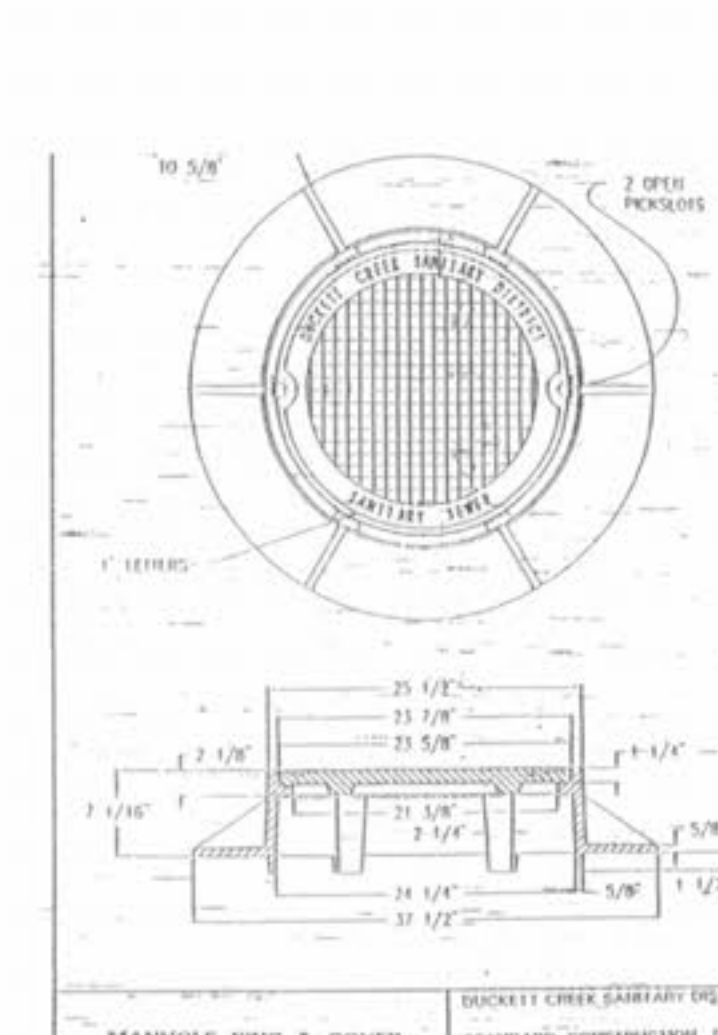
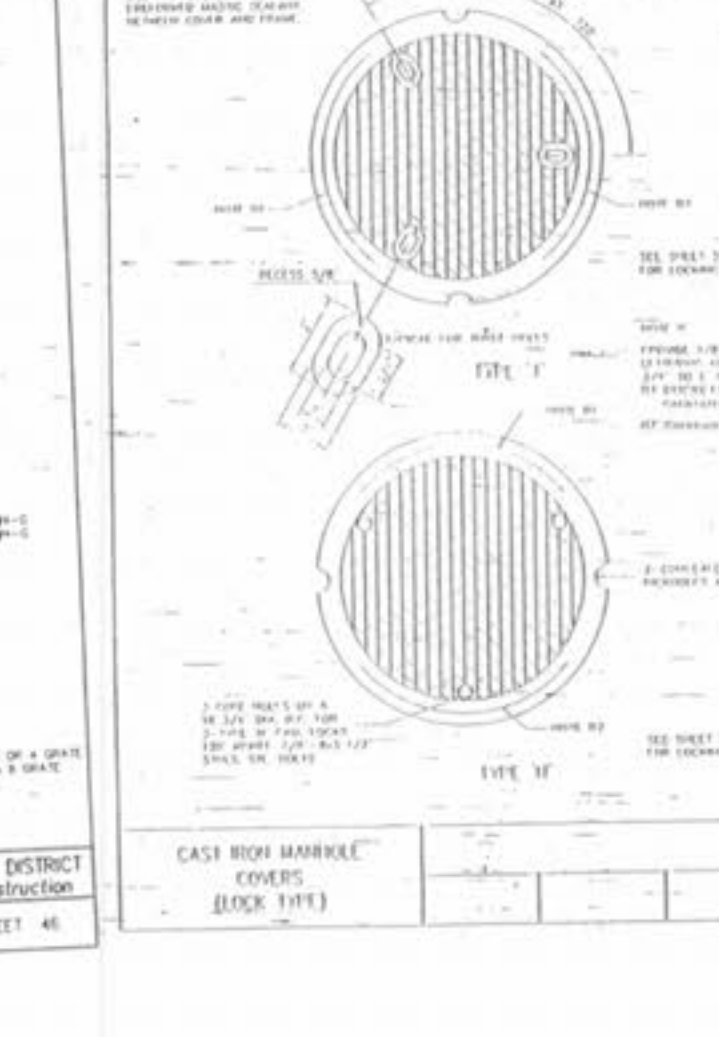
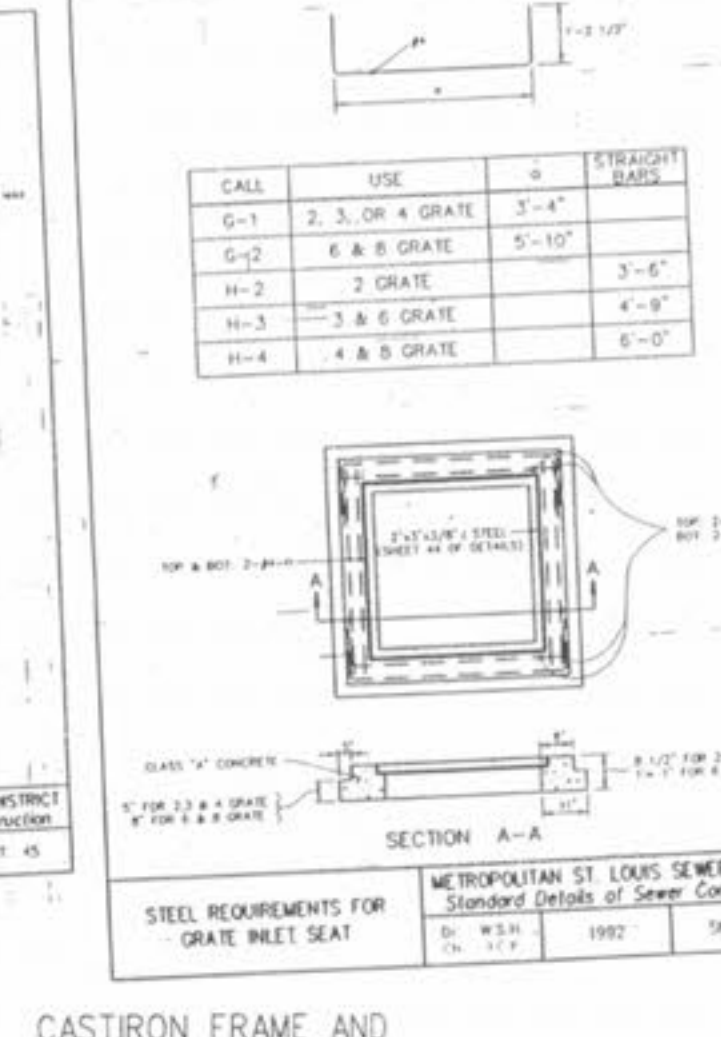
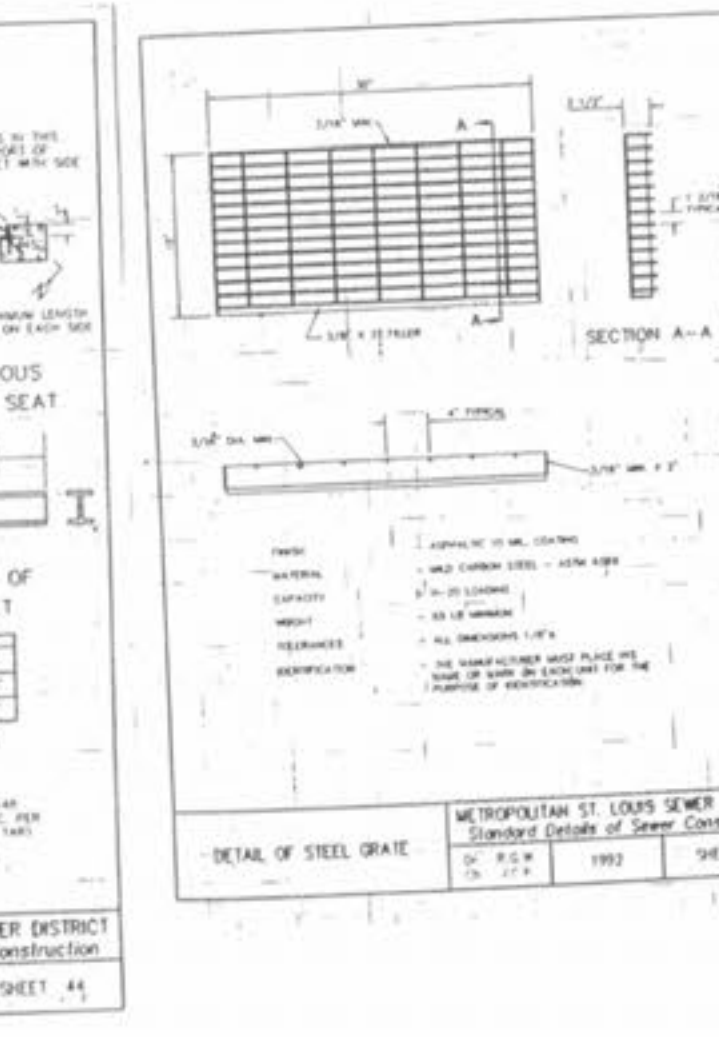
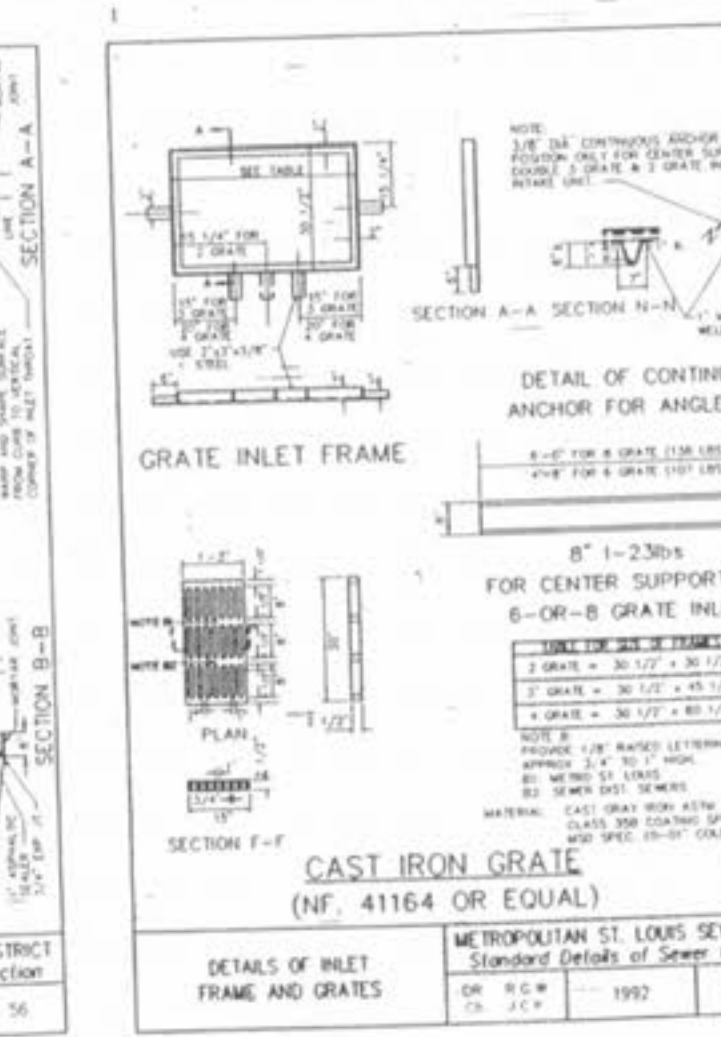
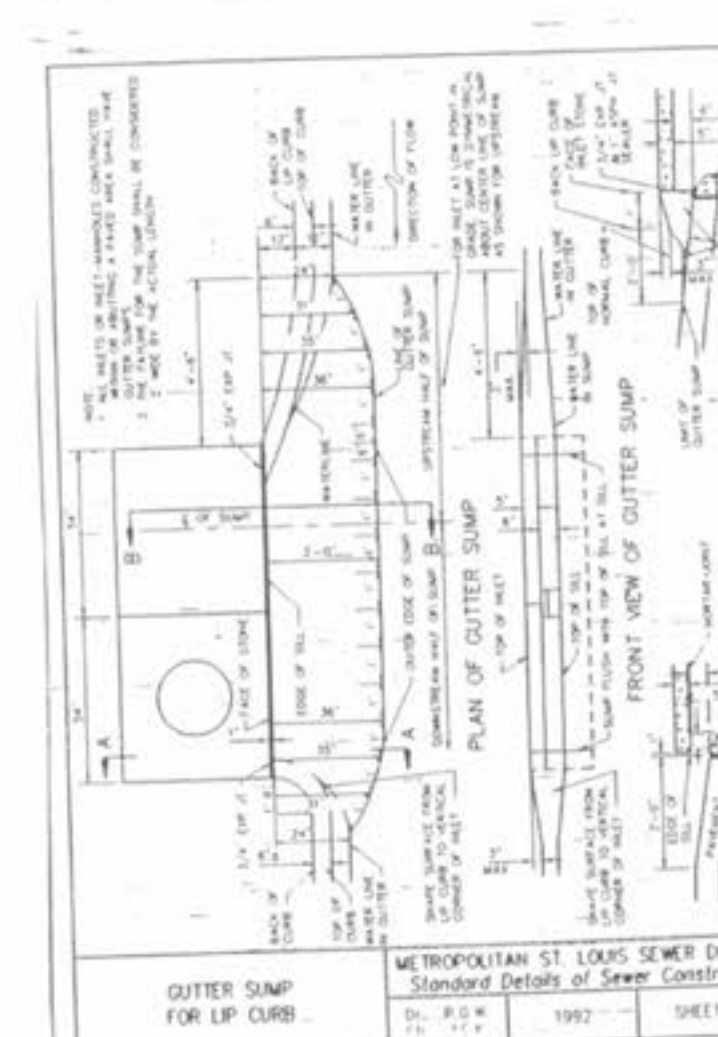
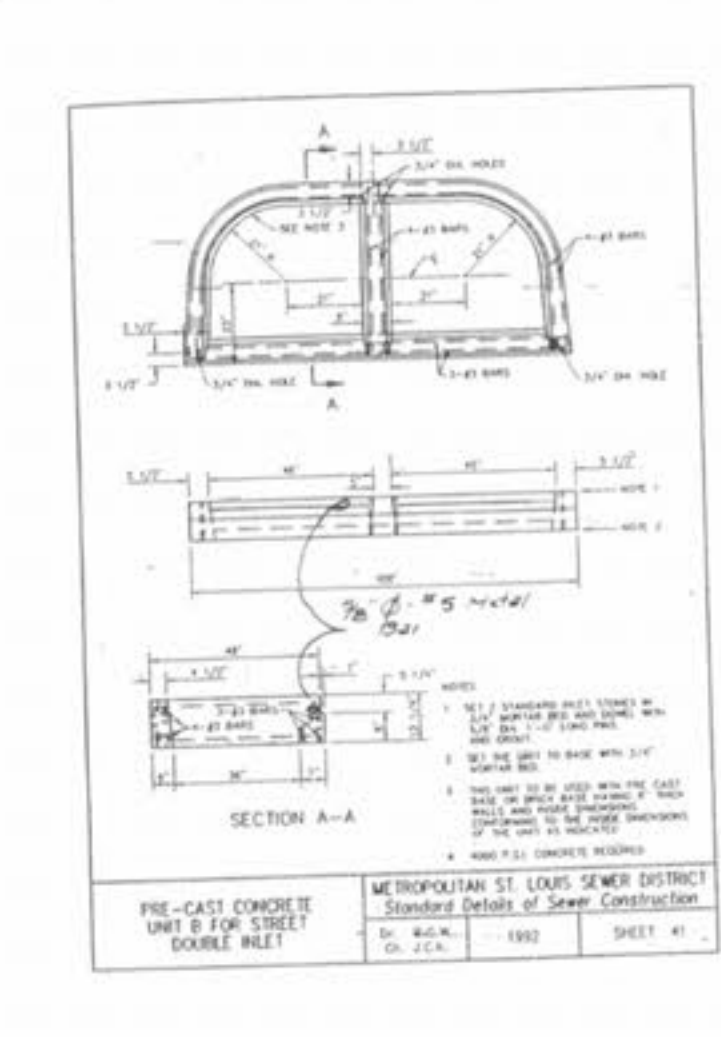
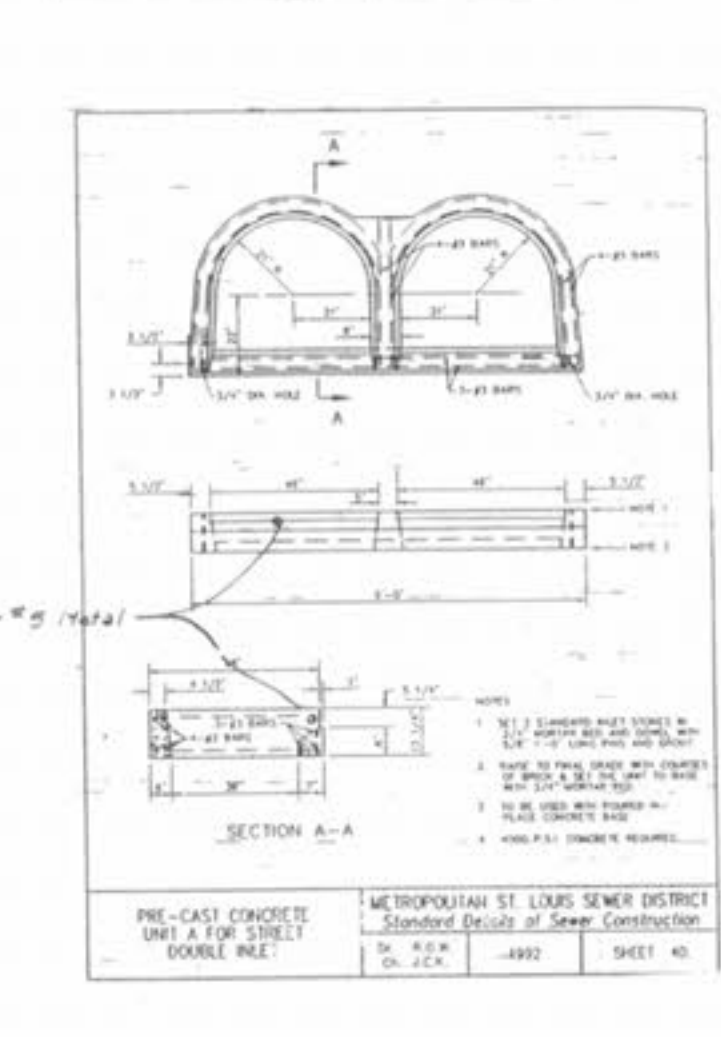
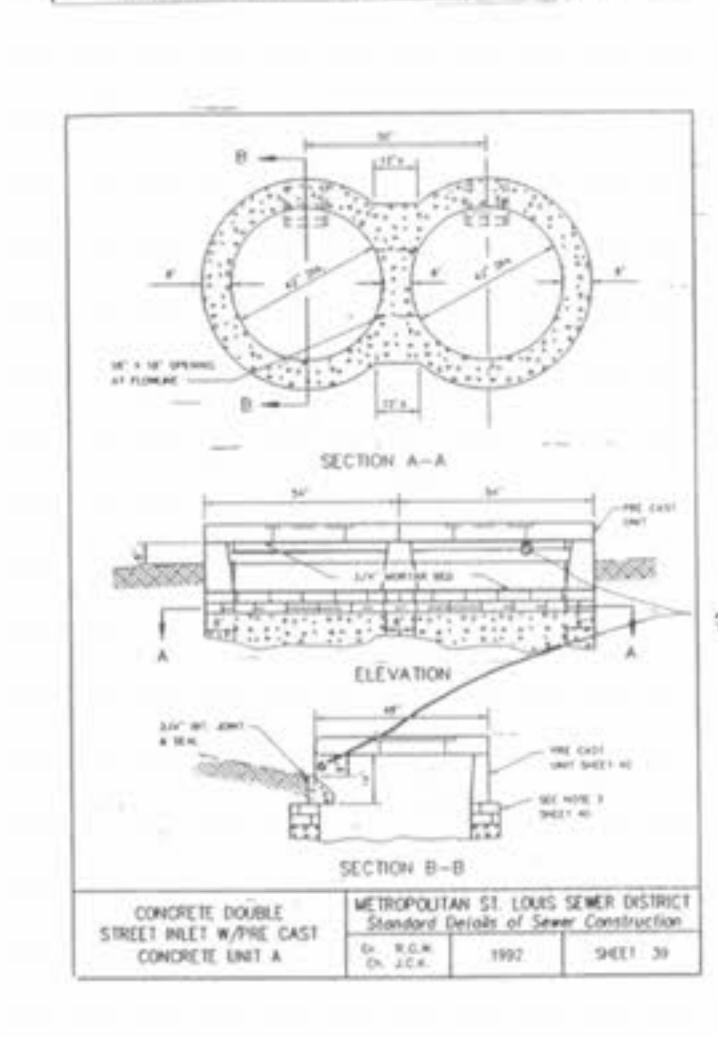
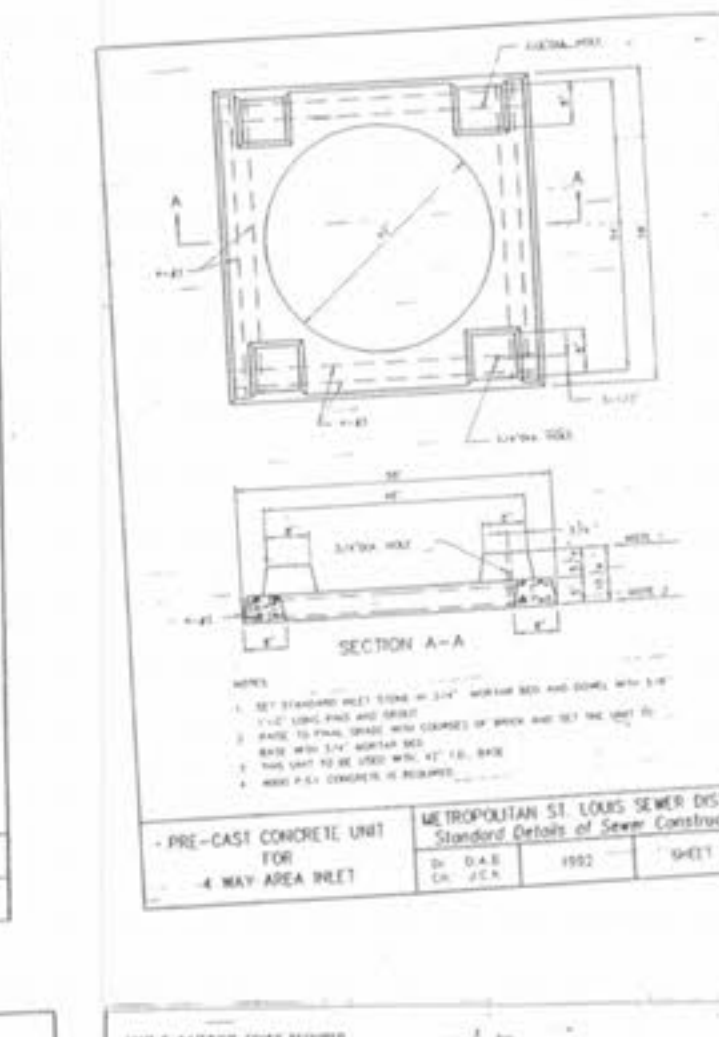
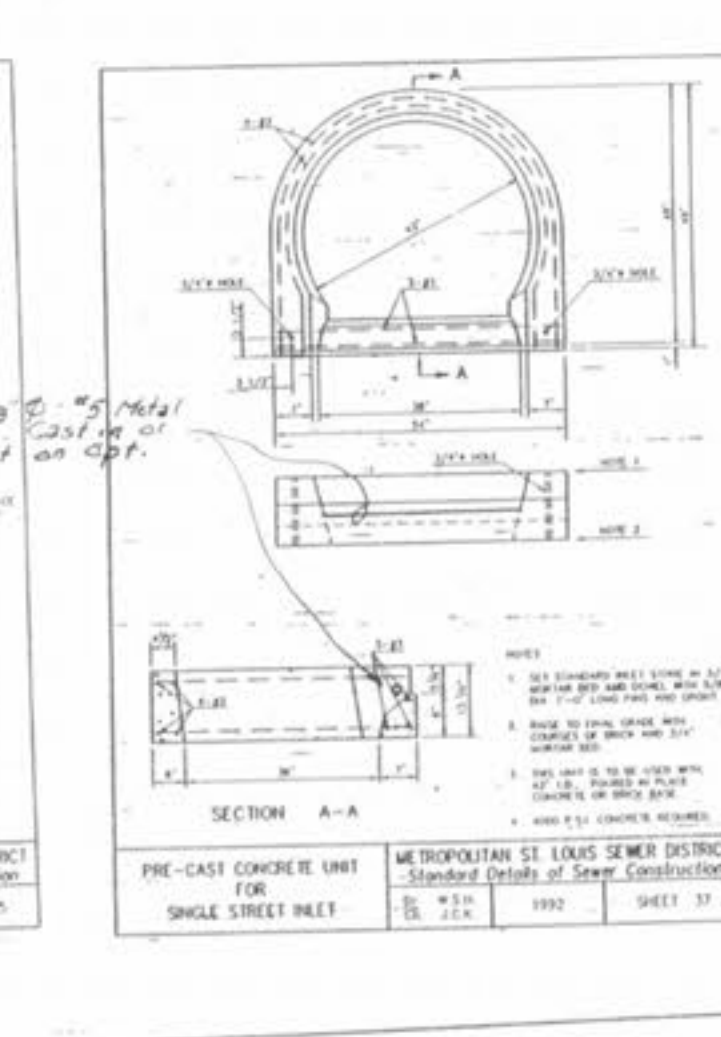
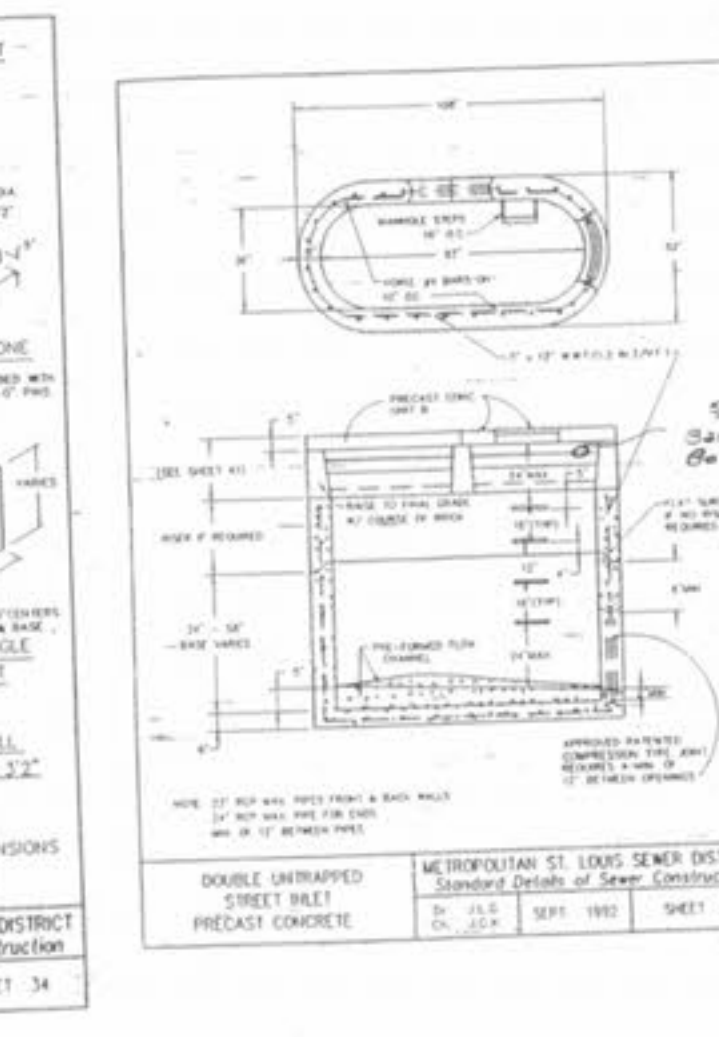
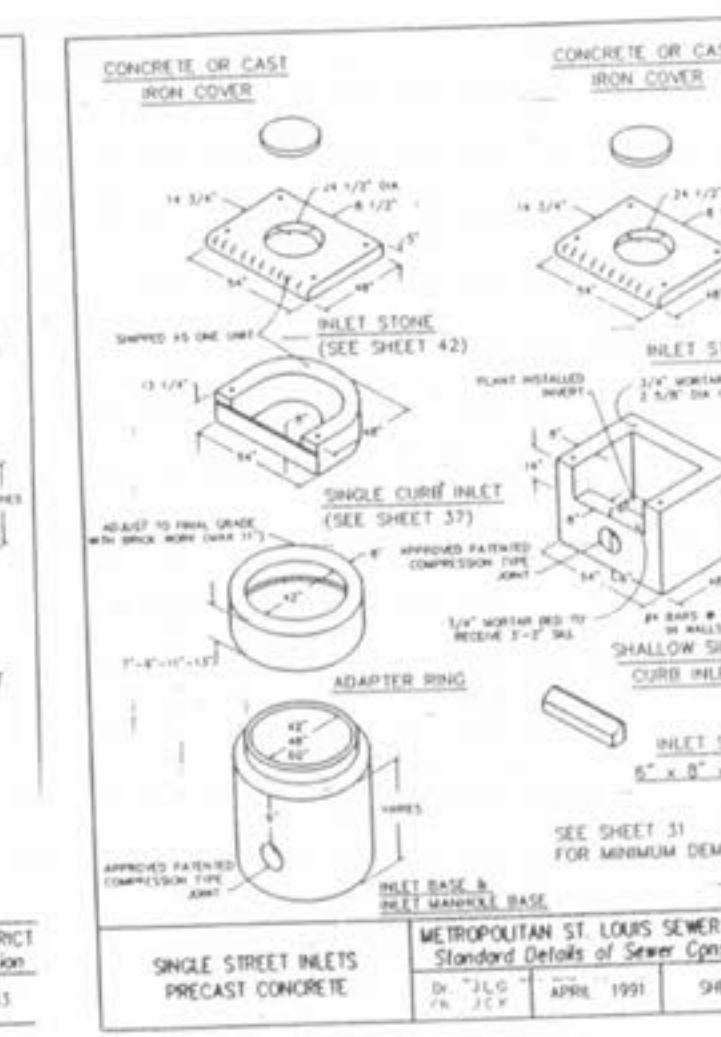
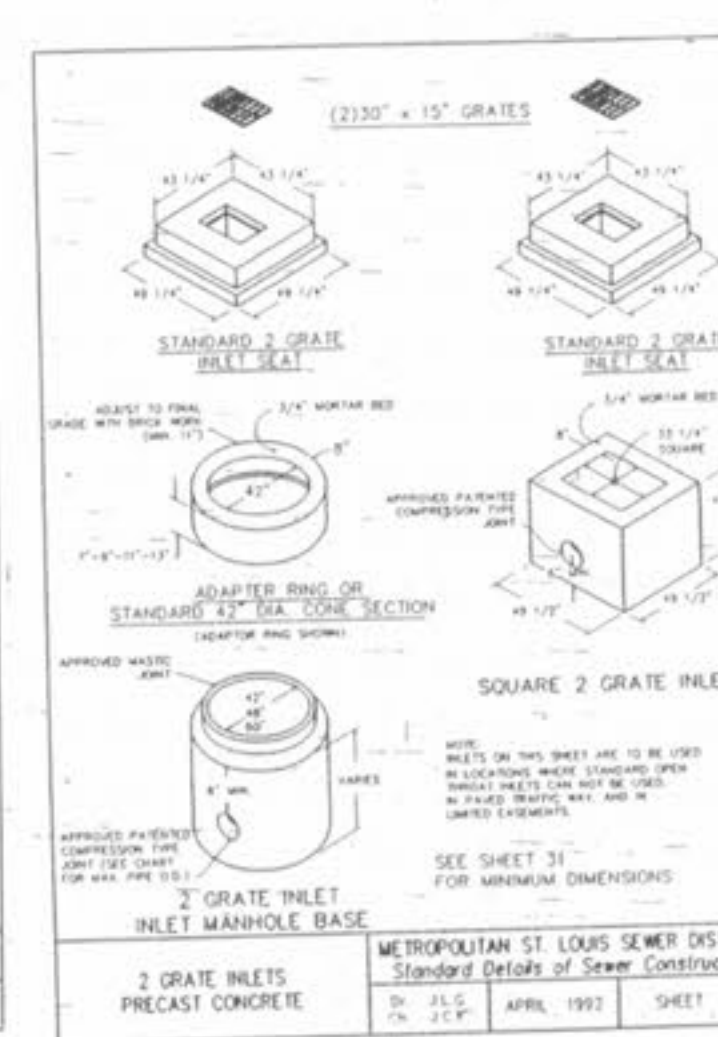
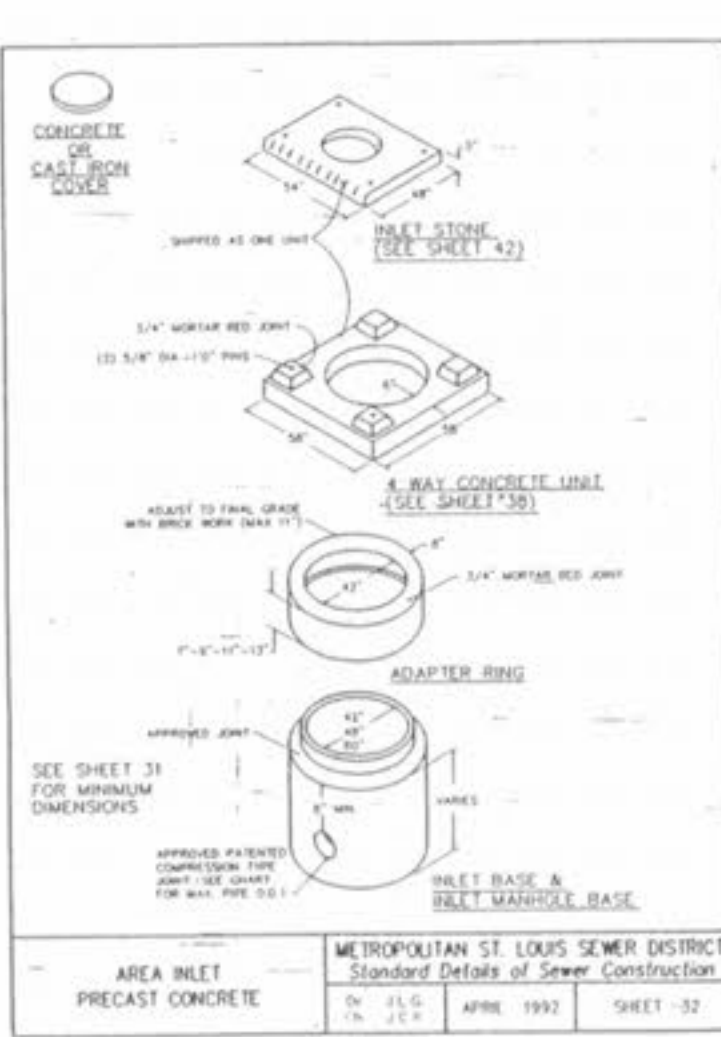
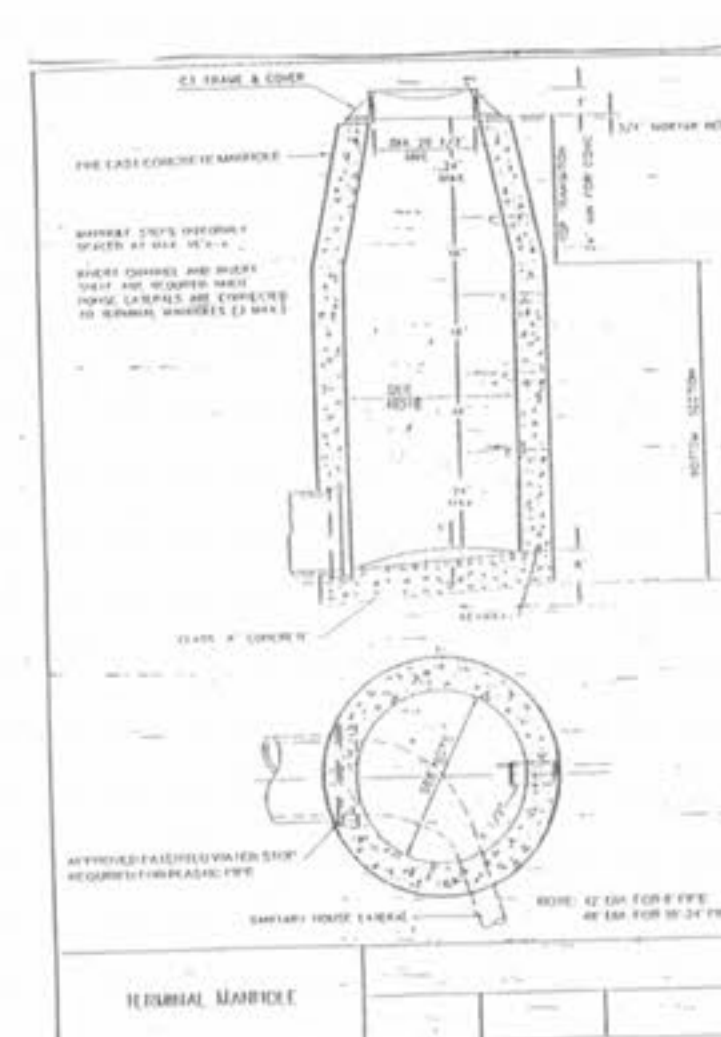
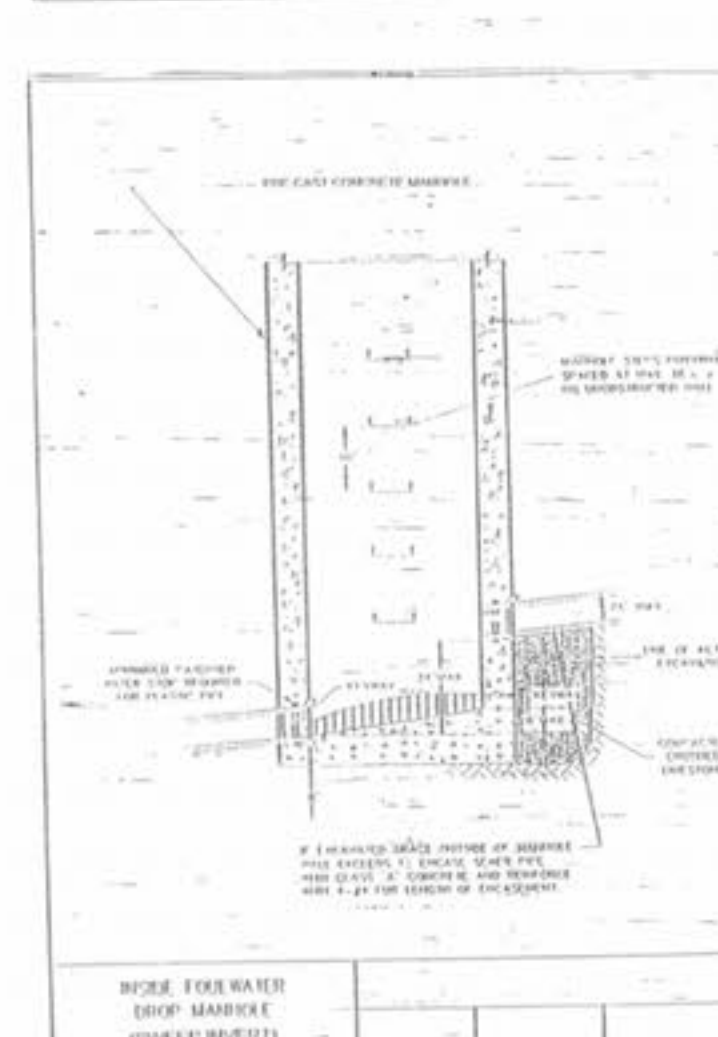
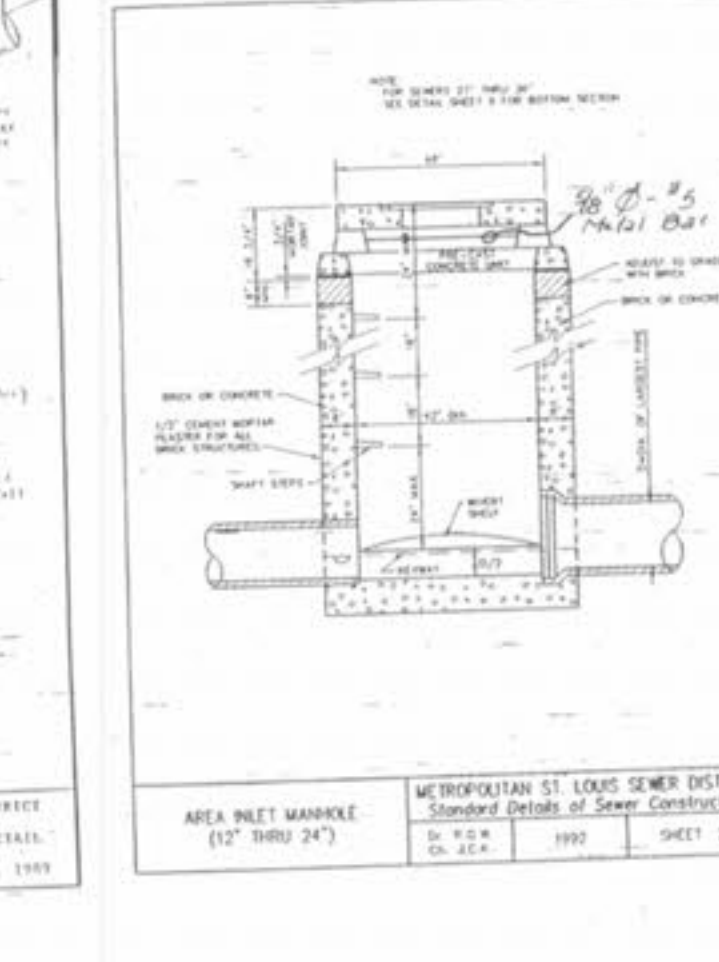
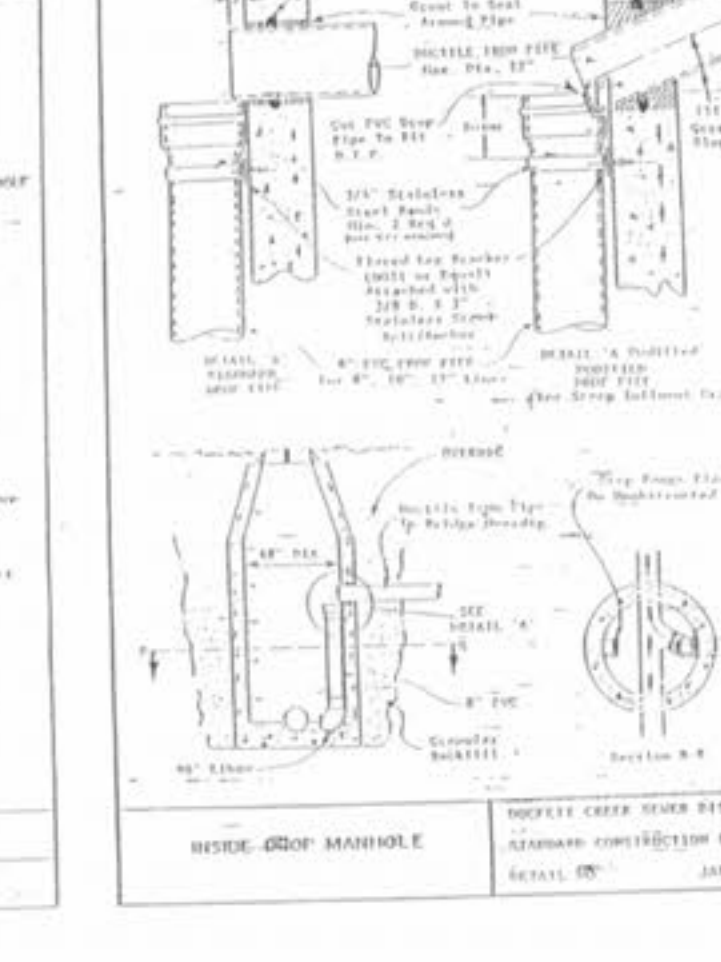
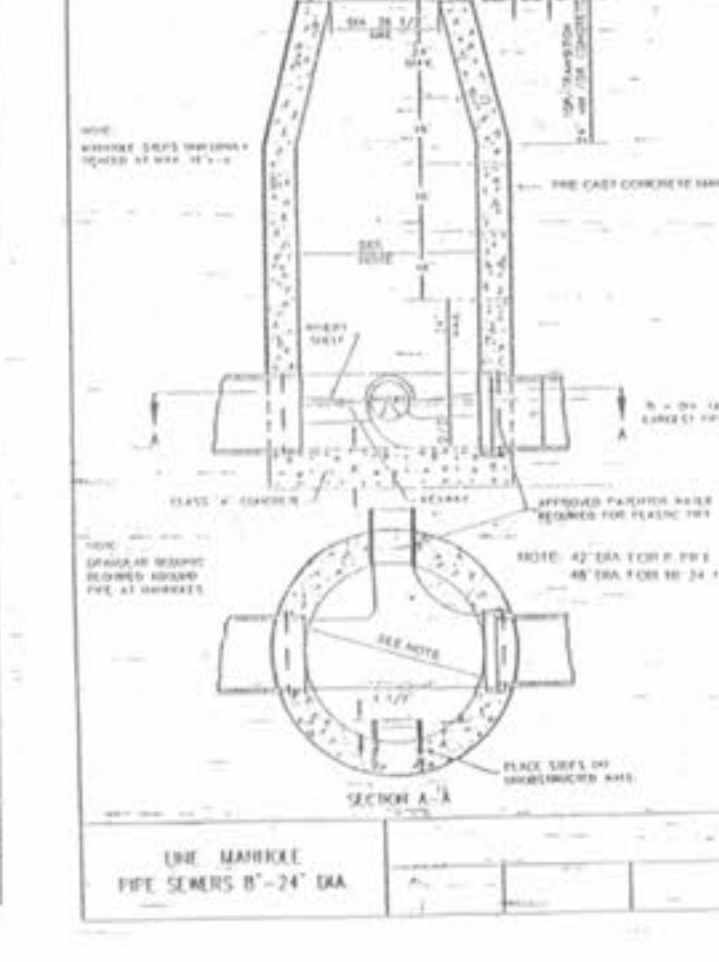
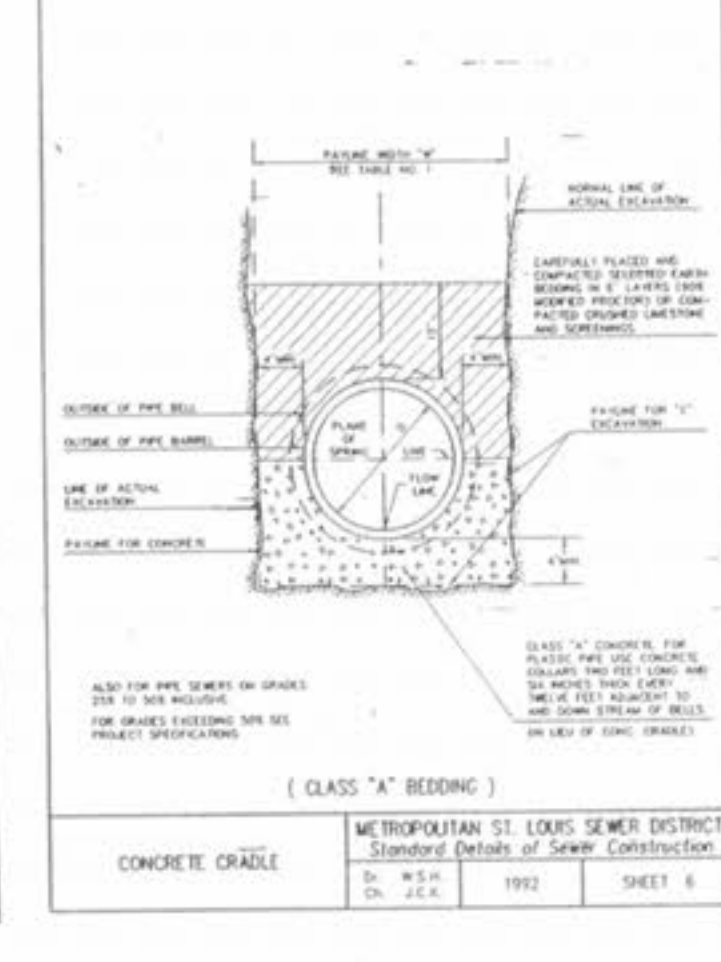
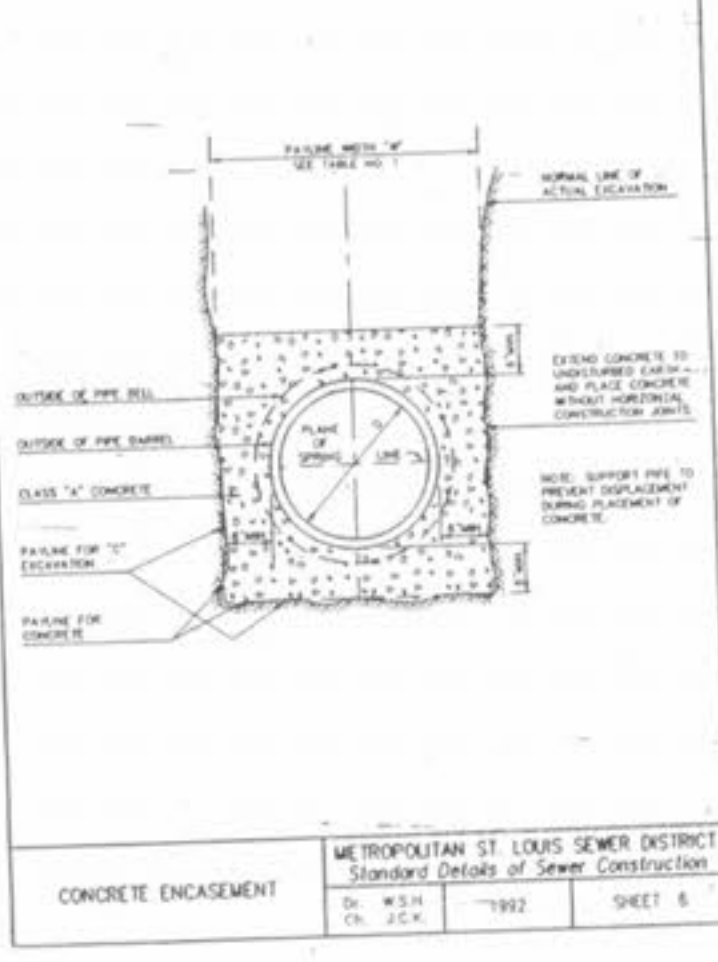
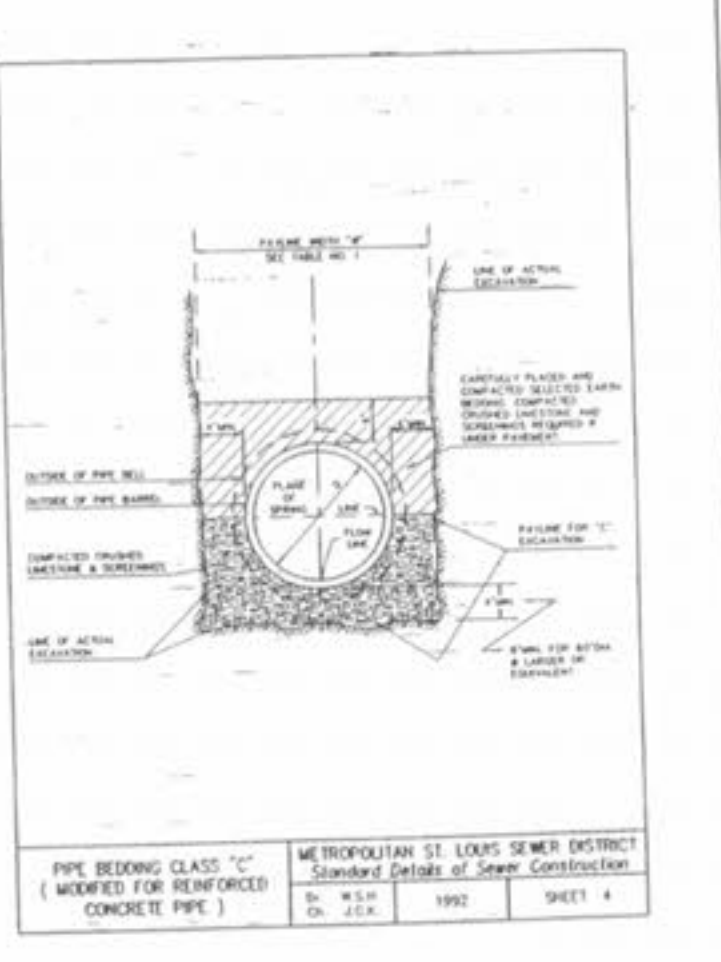
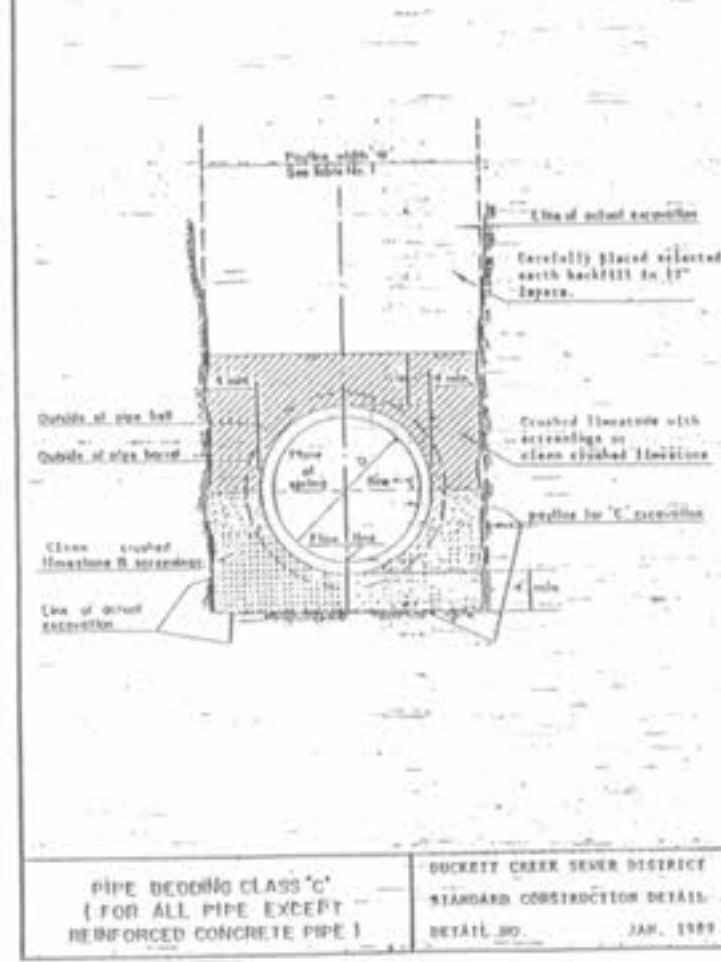

WINGHAVEN
RESIDENTIAL L.L.C.
11140 BRIDGE & SON
CORPORATE CENTER
ST. LOUIS, MISSOURI 63105
PHONE (314) 537-2000

VOLZ

REGISTERED PROFESSIONAL ENGINEER
STATE OF MISSOURI
No. 10000
EXPIRES 12/31/2000

WINGHAVEN

CONSTRUCTION DETAILS

Design By: R.L.M.
Drawn By: M.E.K.
Checked By: E.A.K.

05-24-99

10

B-5000