

ROUND PIPE				HORIZONTAL ELLIPTICAL PIPE			
PIPE DIAMETER (INCHES)	MINIMUM COVER (INCHES)	MINIMUM COVER (INCHES)	MINIMUM COVER (INCHES)	MINIMUM COVER (INCHES)	MINIMUM COVER (INCHES)	MINIMUM COVER (INCHES)	MINIMUM COVER (INCHES)
4	30	2.50	1.50	30	2.50	1.50	30
6	30	2.50	1.50	30	2.50	1.50	30
8	30	2.50	1.50	30	2.50	1.50	30
10	30	2.50	1.50	30	2.50	1.50	30
12	30	2.50	1.50	30	2.50	1.50	30
14	30	2.50	1.50	30	2.50	1.50	30
16	30	2.50	1.50	30	2.50	1.50	30
18	30	2.50	1.50	30	2.50	1.50	30
20	30	2.50	1.50	30	2.50	1.50	30
22	30	2.50	1.50	30	2.50	1.50	30
24	30	2.50	1.50	30	2.50	1.50	30
26	30	2.50	1.50	30	2.50	1.50	30
28	30	2.50	1.50	30	2.50	1.50	30
30	30	2.50	1.50	30	2.50	1.50	30
32	30	2.50	1.50	30	2.50	1.50	30
34	30	2.50	1.50	30	2.50	1.50	30
36	30	2.50	1.50	30	2.50	1.50	30
38	30	2.50	1.50	30	2.50	1.50	30
40	30	2.50	1.50	30	2.50	1.50	30
42	30	2.50	1.50	30	2.50	1.50	30
44	30	2.50	1.50	30	2.50	1.50	30
46	30	2.50	1.50	30	2.50	1.50	30
48	30	2.50	1.50	30	2.50	1.50	30
50	30	2.50	1.50	30	2.50	1.50	30
52	30	2.50	1.50	30	2.50	1.50	30
54	30	2.50	1.50	30	2.50	1.50	30
56	30	2.50	1.50	30	2.50	1.50	30
58	30	2.50	1.50	30	2.50	1.50	30
60	30	2.50	1.50	30	2.50	1.50	30
62	30	2.50	1.50	30	2.50	1.50	30
64	30	2.50	1.50	30	2.50	1.50	30
66	30	2.50	1.50	30	2.50	1.50	30
68	30	2.50	1.50	30	2.50	1.50	30
70	30	2.50	1.50	30	2.50	1.50	30
72	30	2.50	1.50	30	2.50	1.50	30
74	30	2.50	1.50	30	2.50	1.50	30
76	30	2.50	1.50	30	2.50	1.50	30
78	30	2.50	1.50	30	2.50	1.50	30
80	30	2.50	1.50	30	2.50	1.50	30
82	30	2.50	1.50	30	2.50	1.50	30
84	30	2.50	1.50	30	2.50	1.50	30
86	30	2.50	1.50	30	2.50	1.50	30
88	30	2.50	1.50	30	2.50	1.50	30
90	30	2.50	1.50	30	2.50	1.50	30
92	30	2.50	1.50	30	2.50	1.50	30
94	30	2.50	1.50	30	2.50	1.50	30
96	30	2.50	1.50	30	2.50	1.50	30
98	30	2.50	1.50	30	2.50	1.50	30
100	30	2.50	1.50	30	2.50	1.50	30

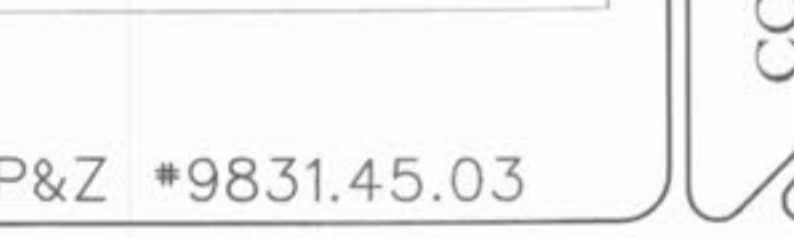

WINGHAVEN
RESIDENTIAL L.L.C.
4141 MCBRIDE & SON
CENTER DRIVE
ST. LOUIS, MISSOURI 63005
PHONE (636) 537-2000

VOLZ

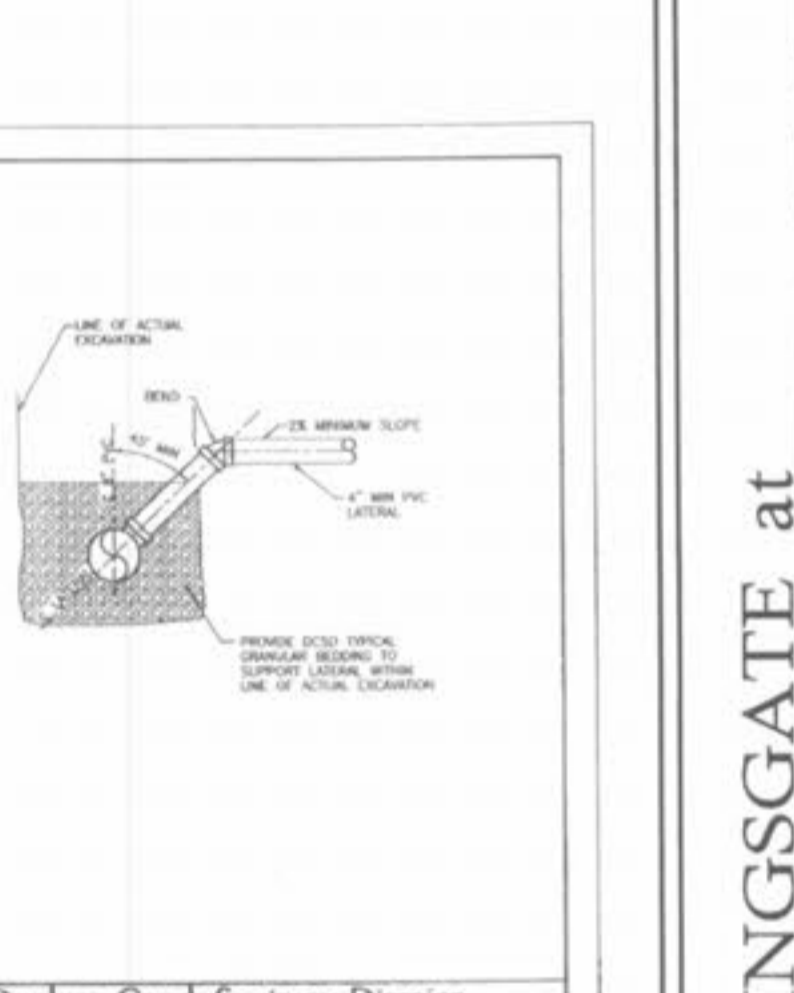
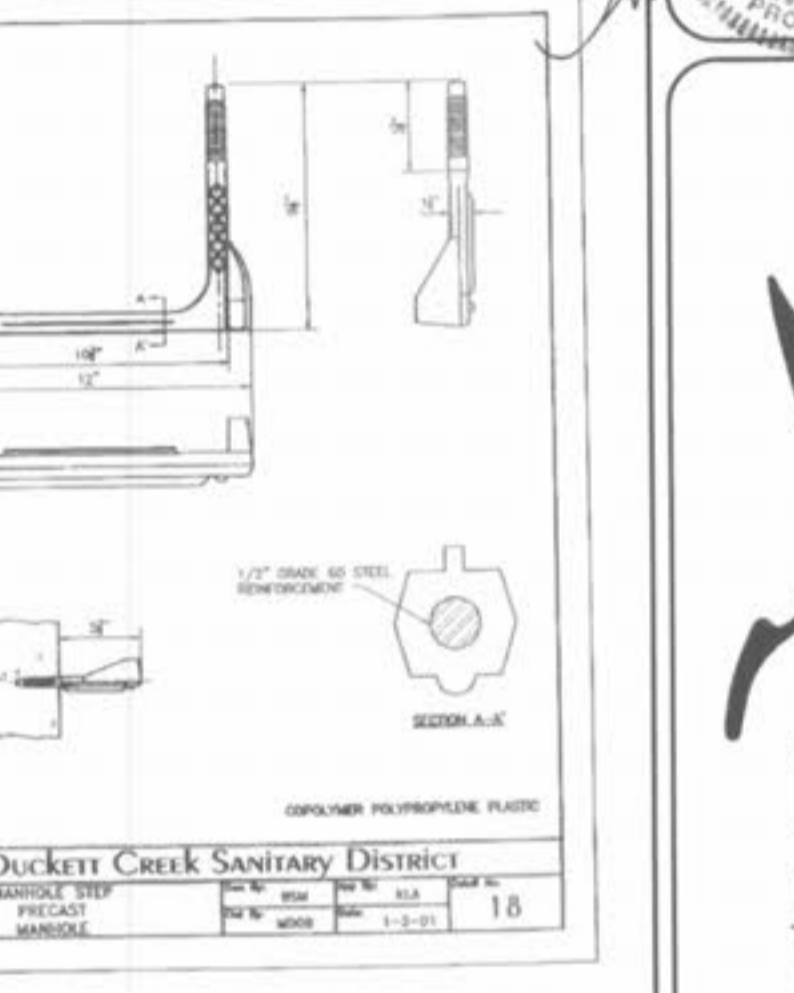
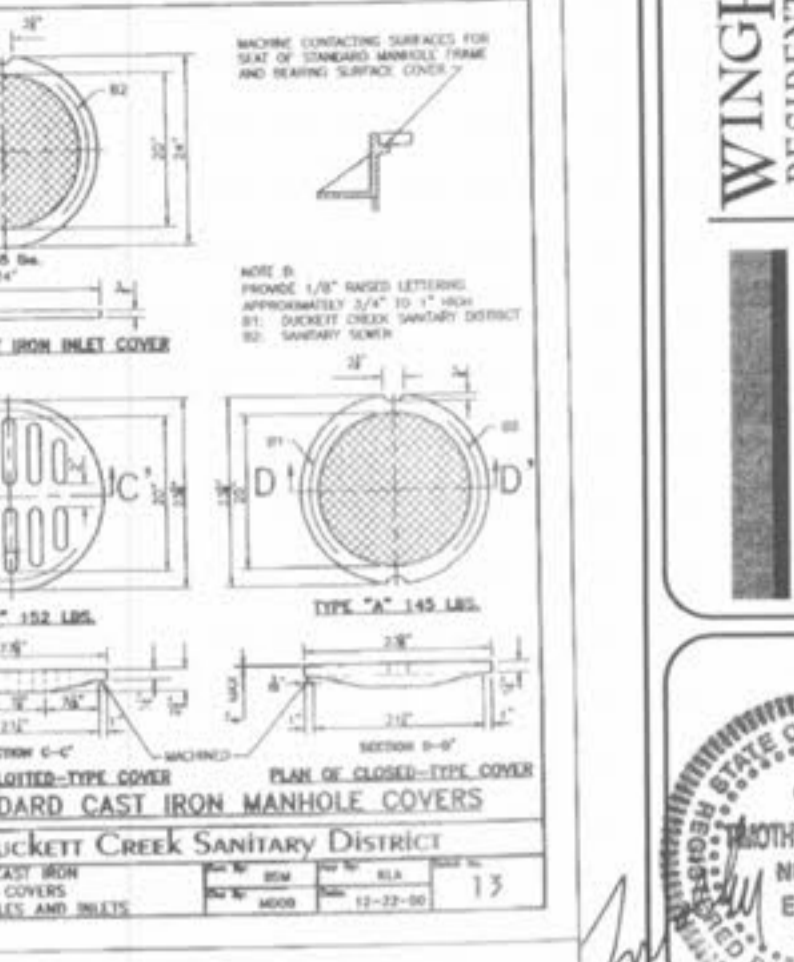
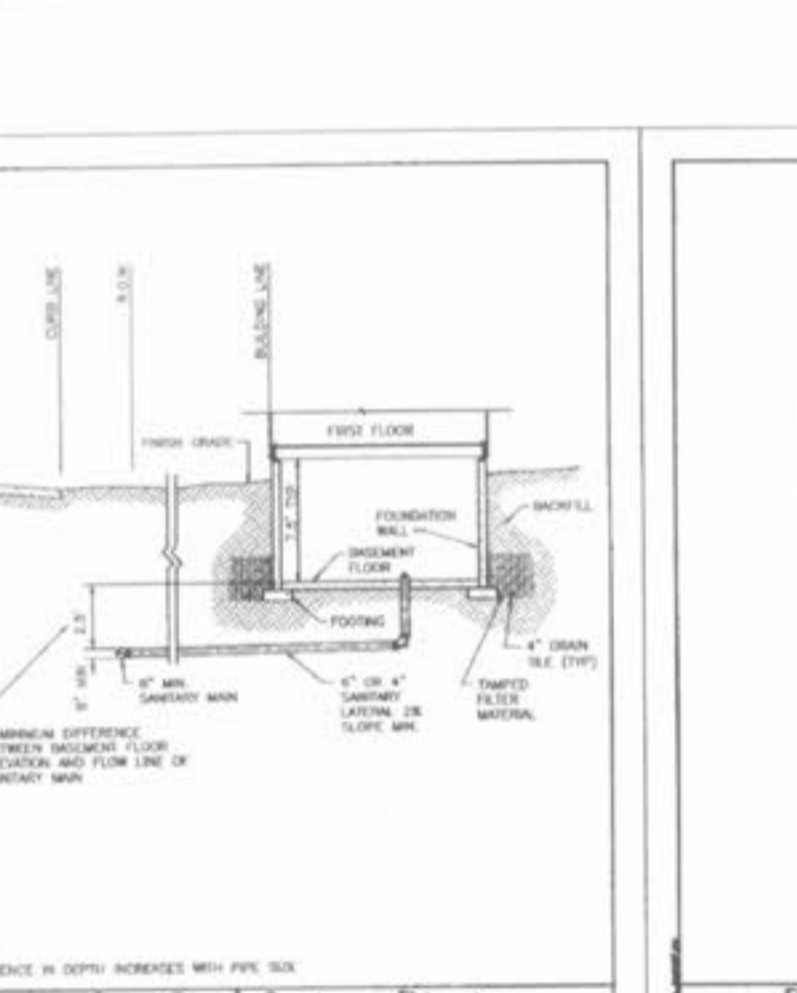
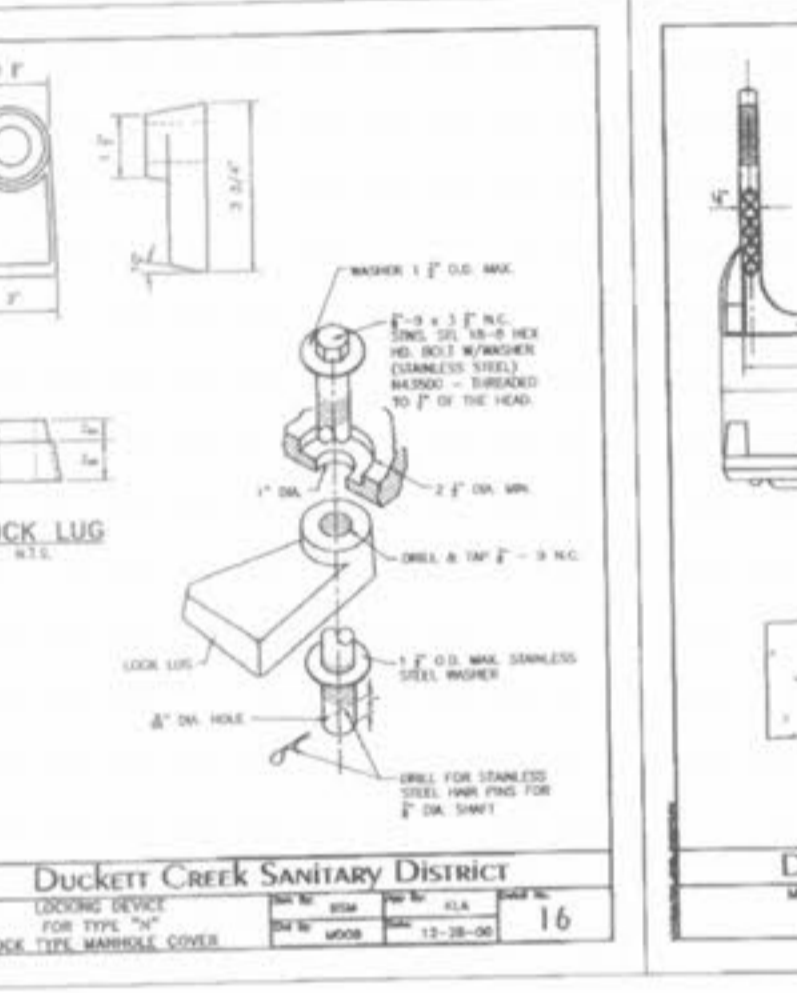
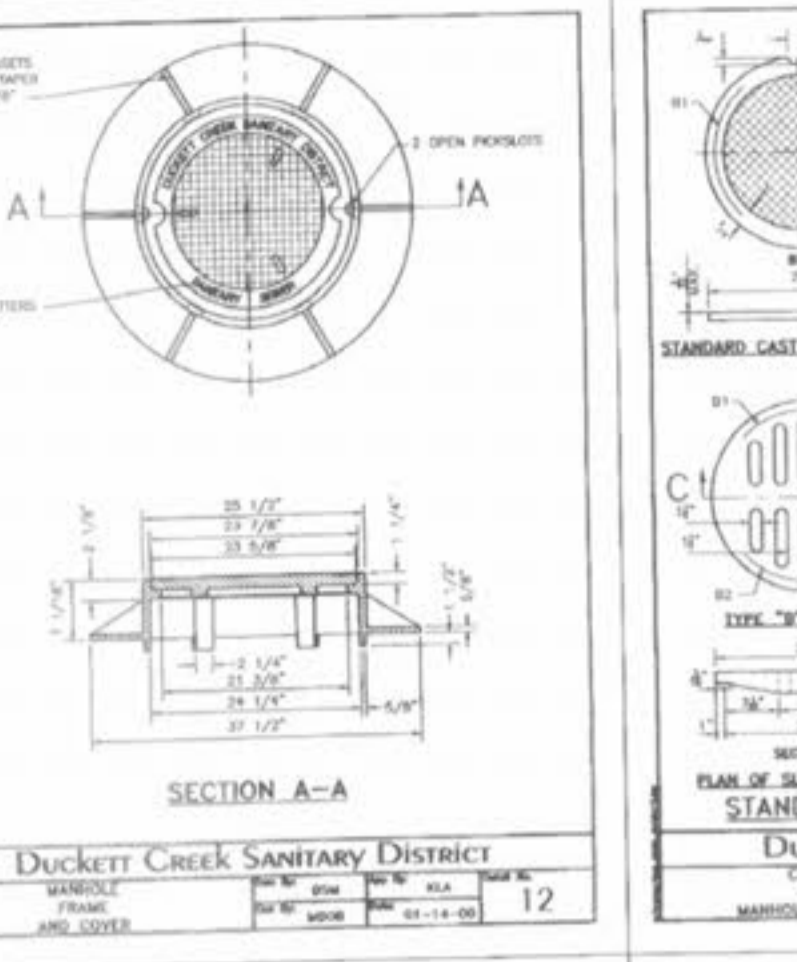
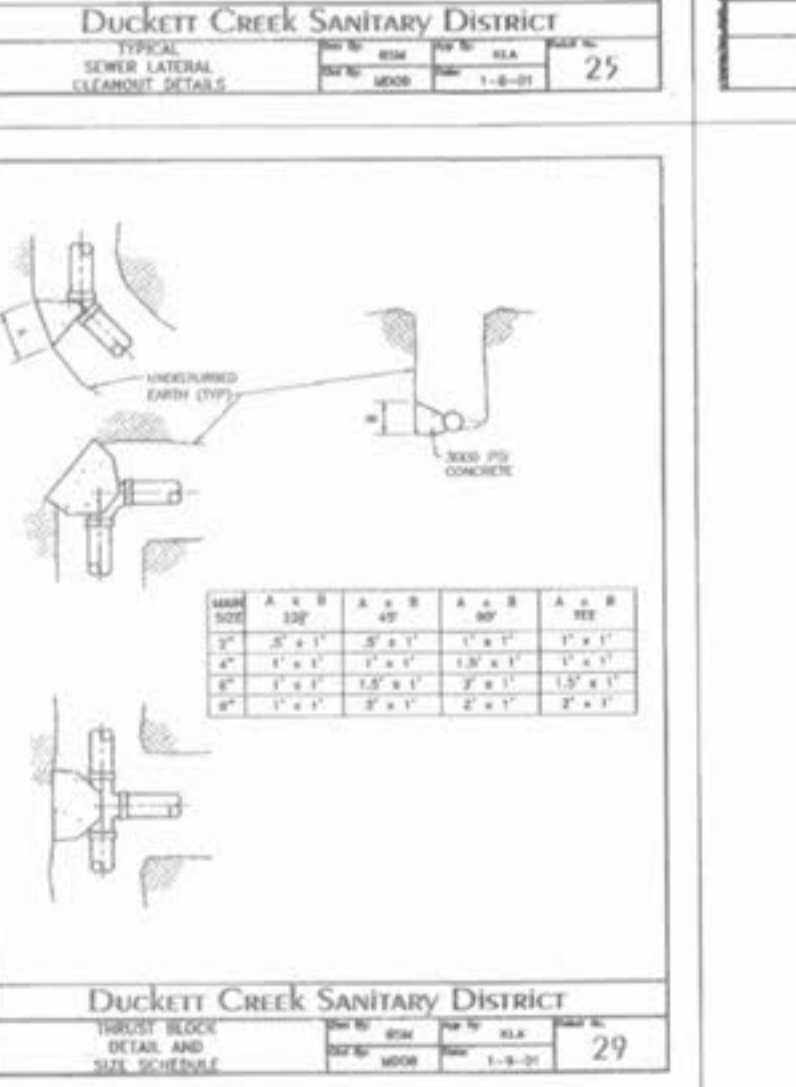
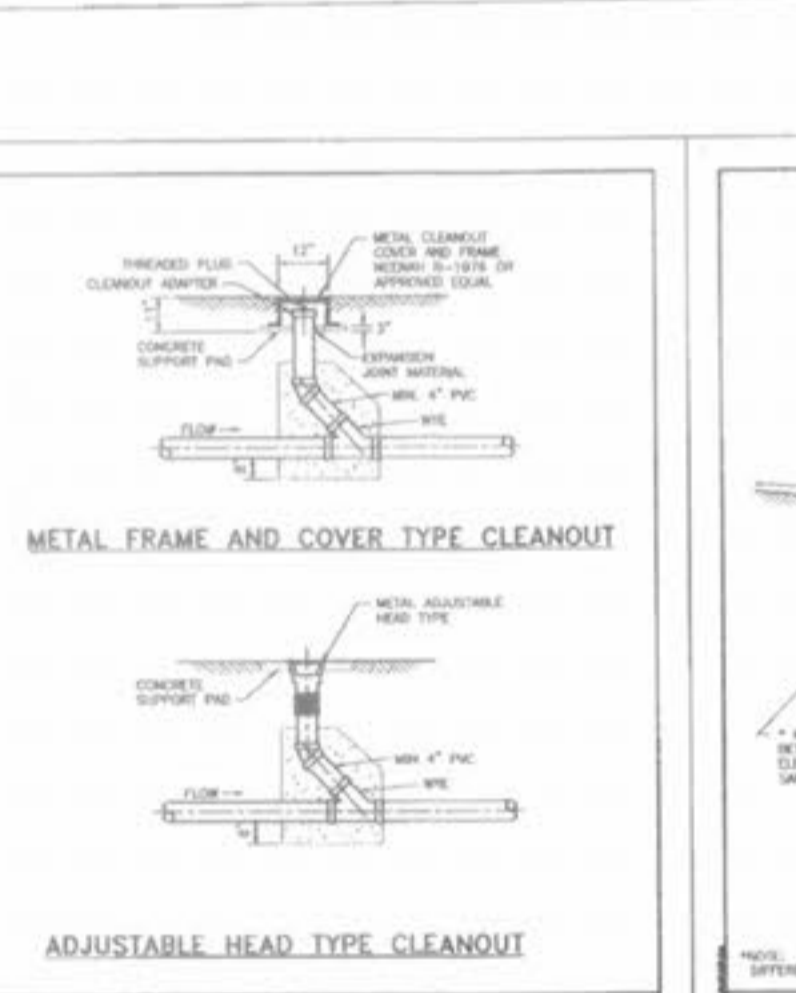
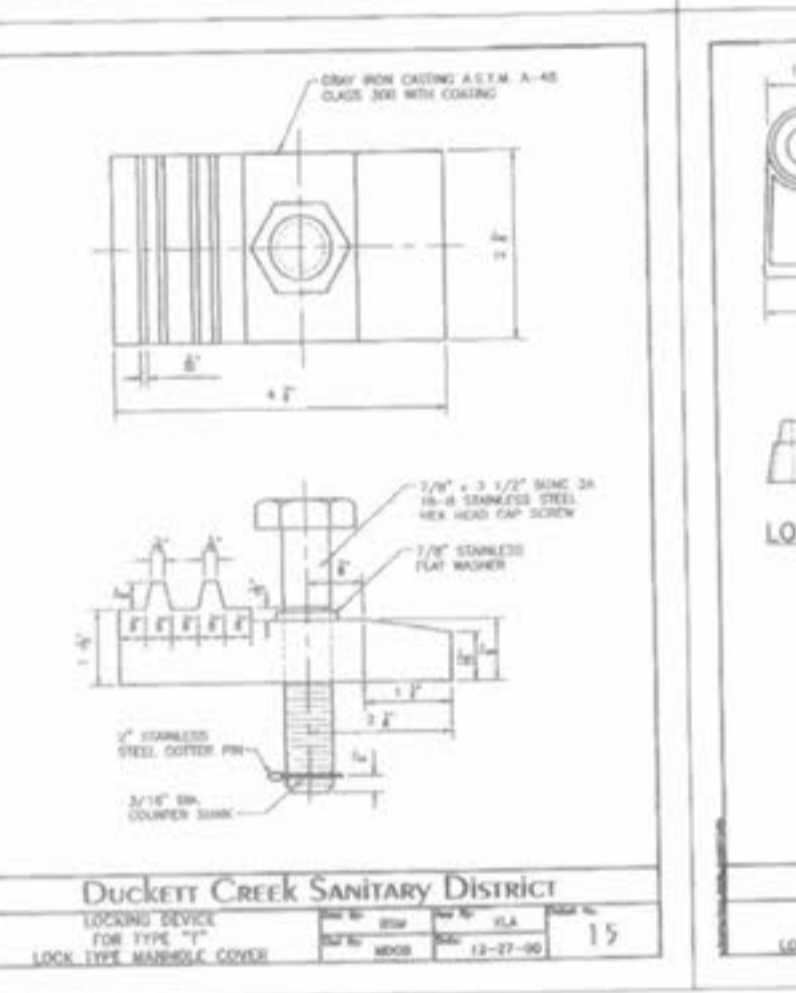
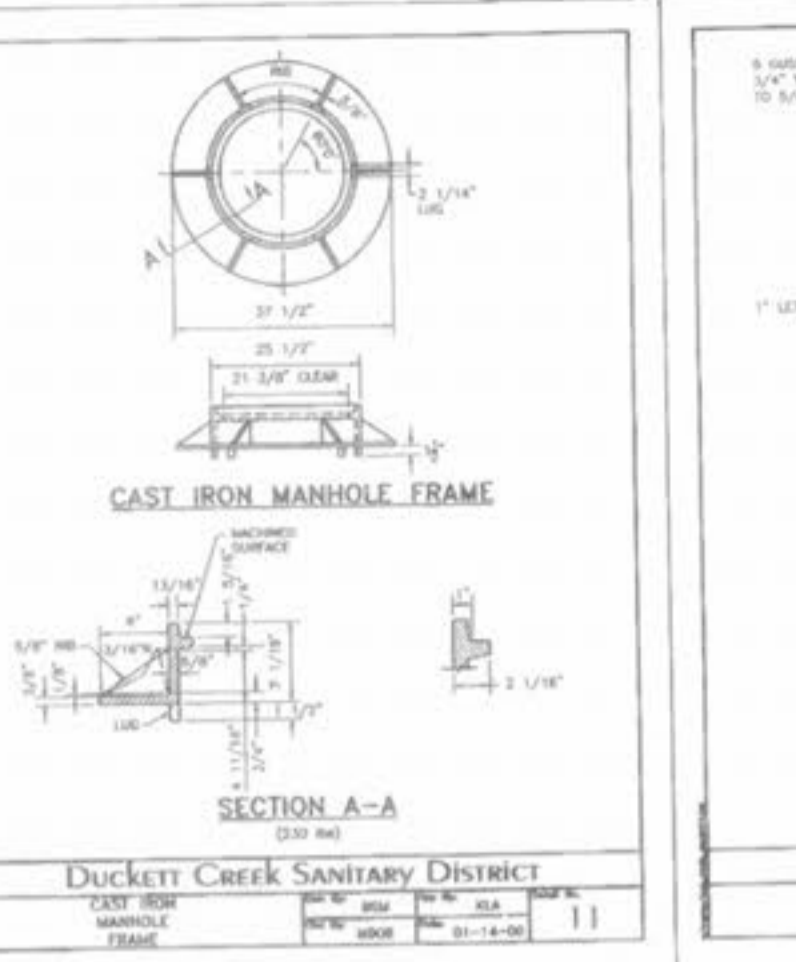
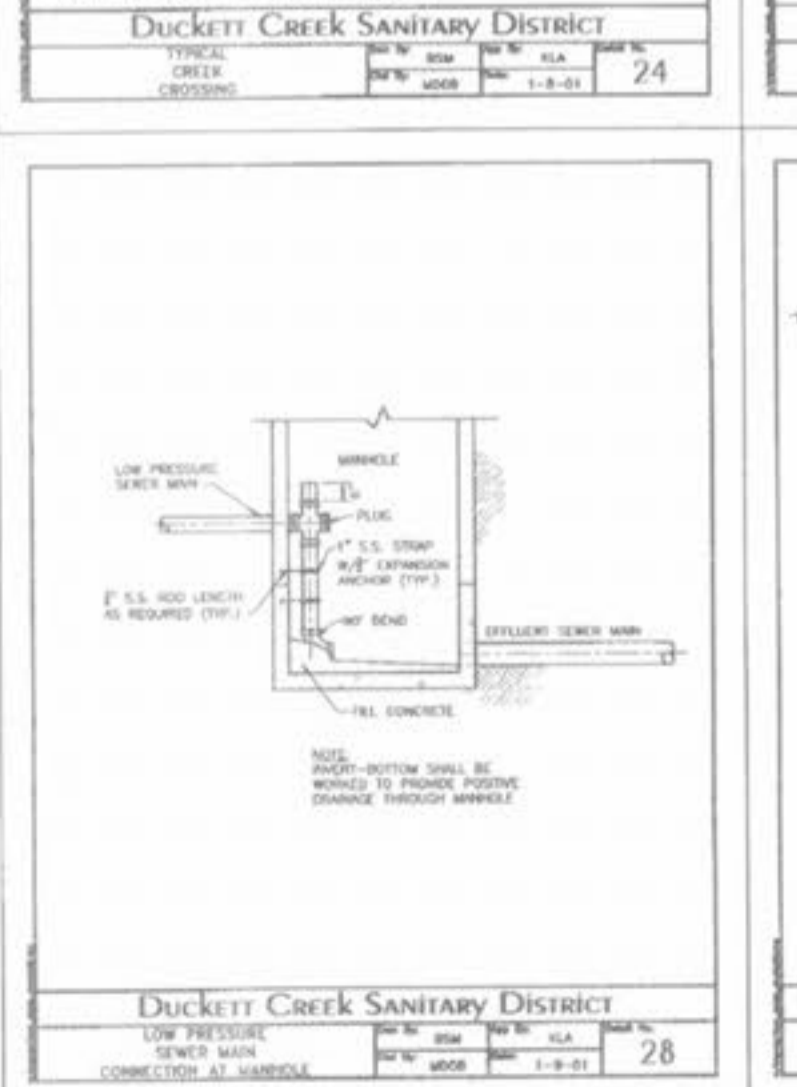
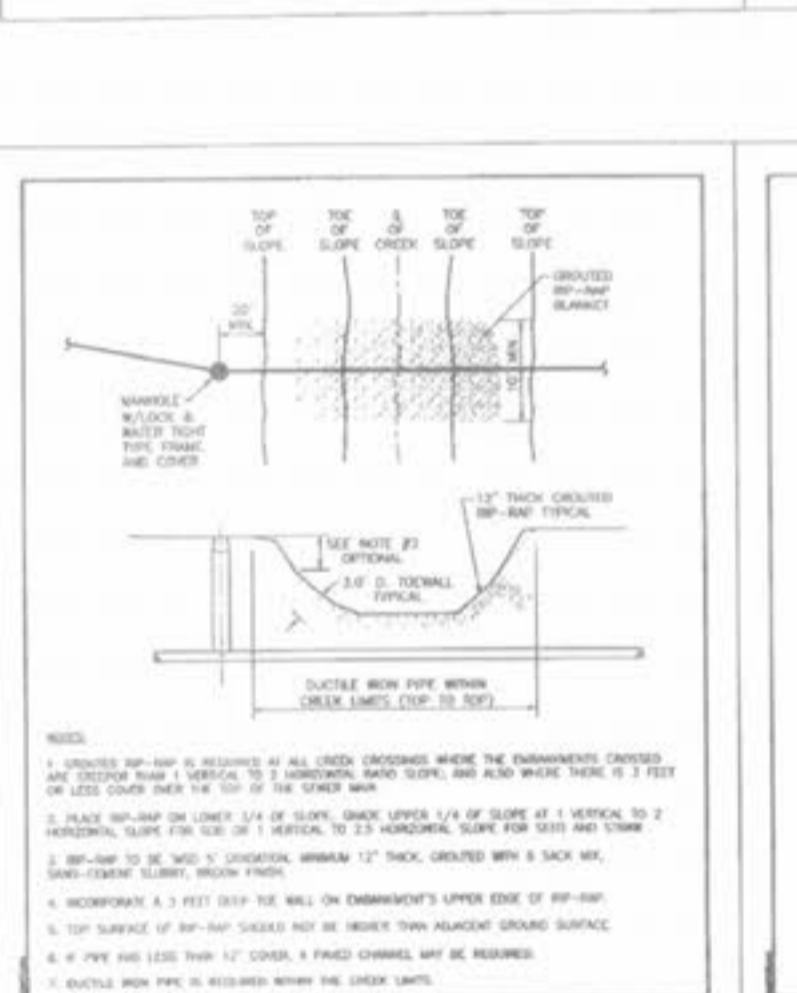
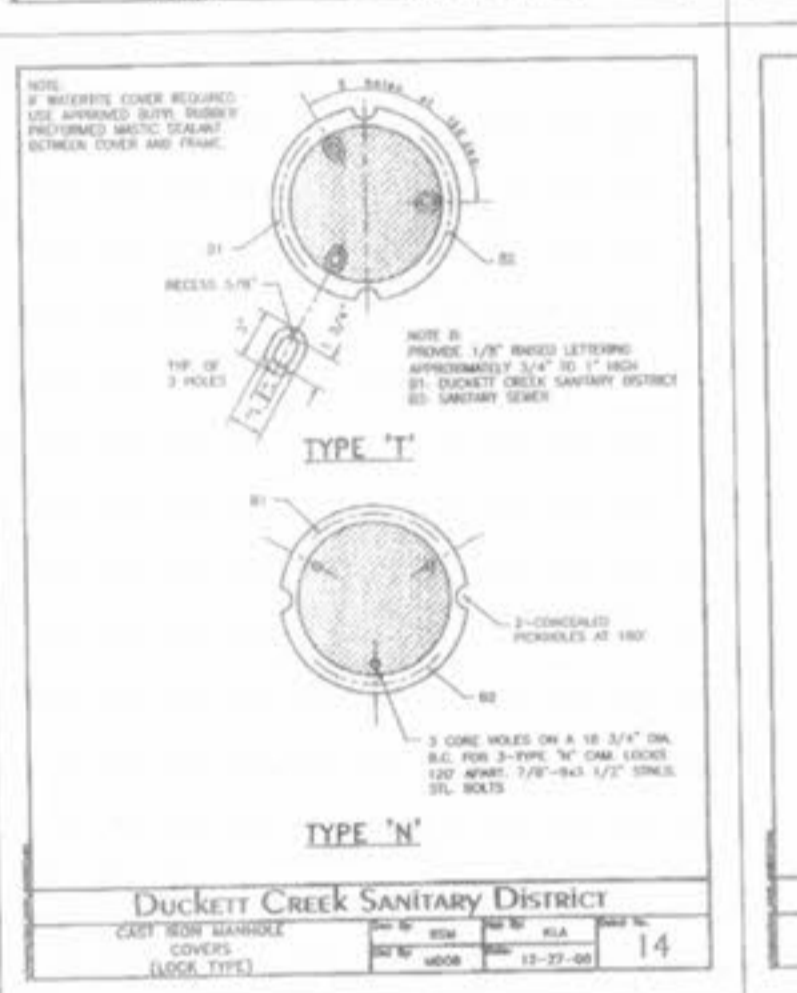
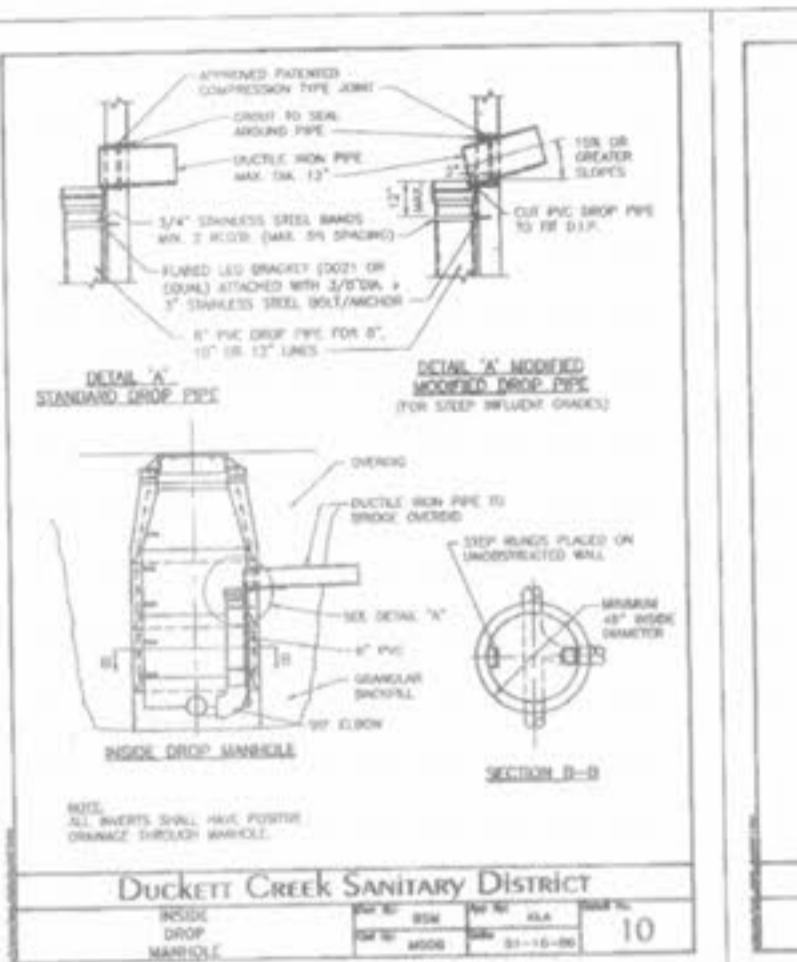
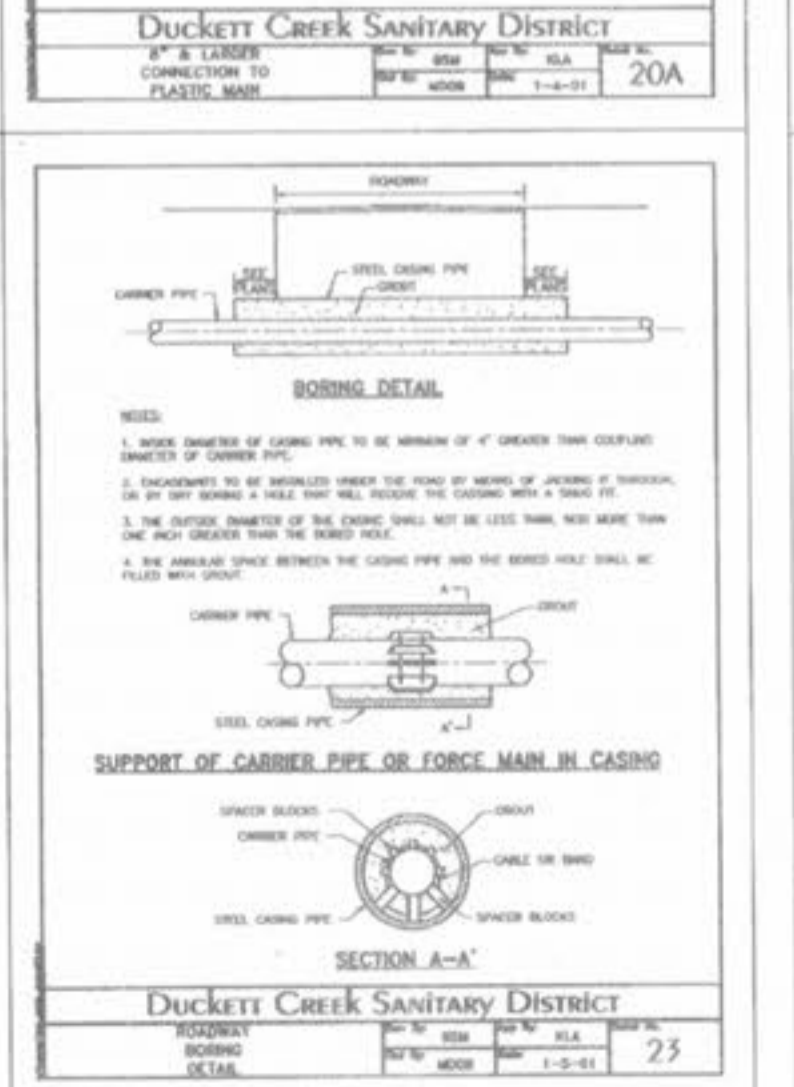
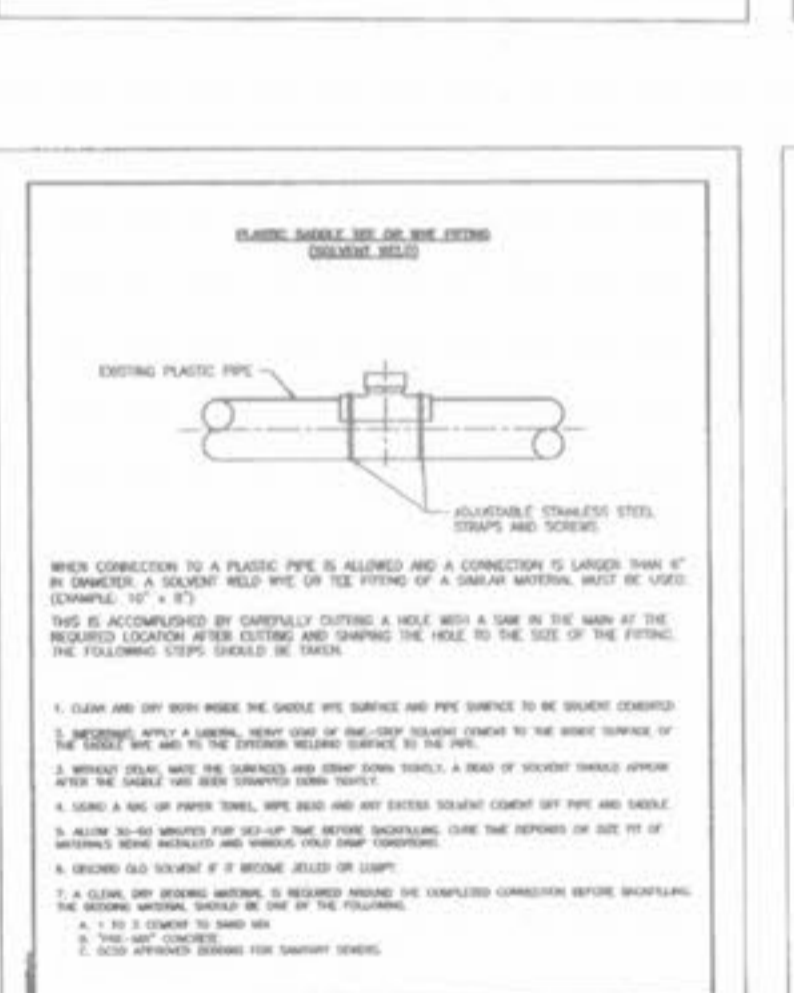
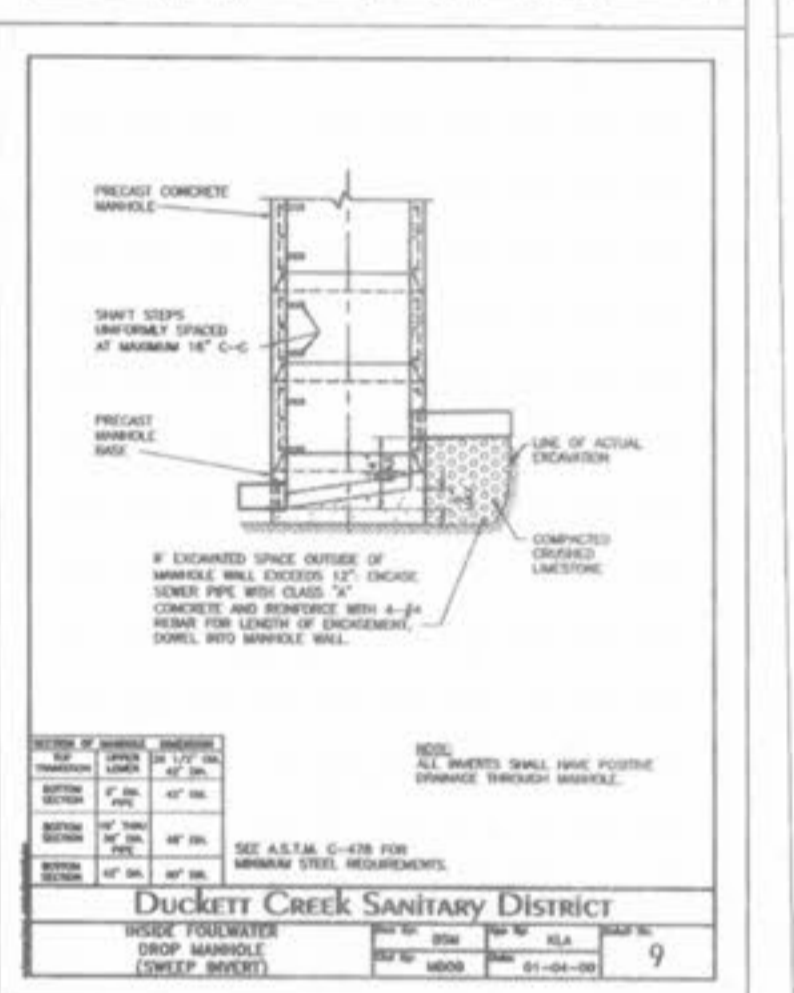
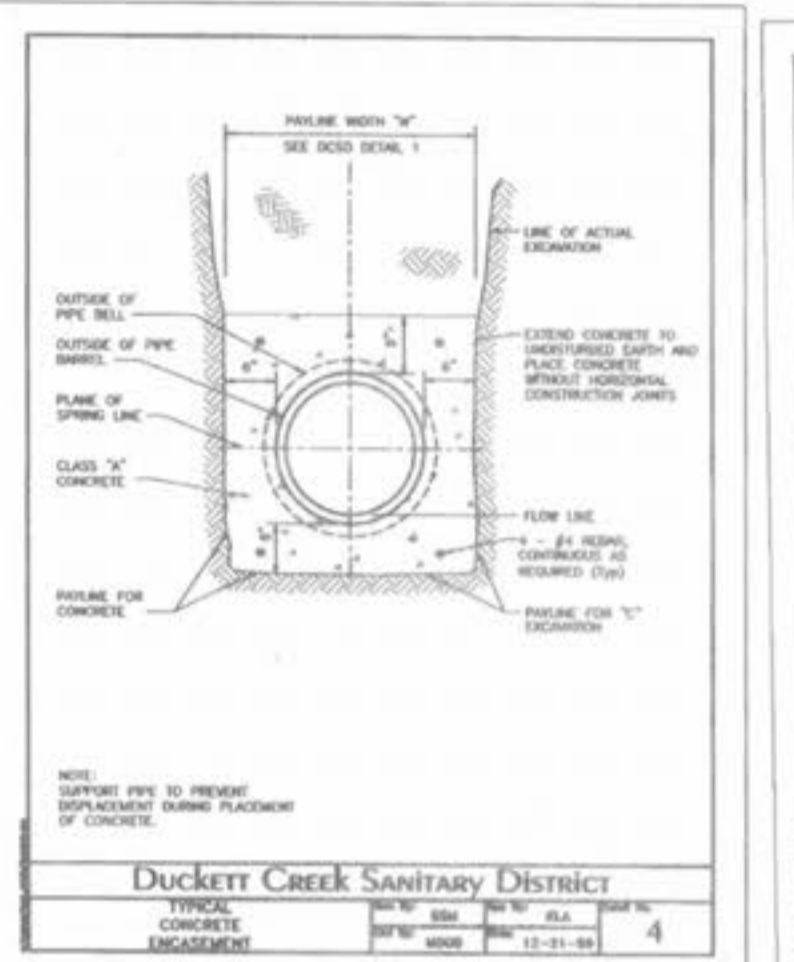
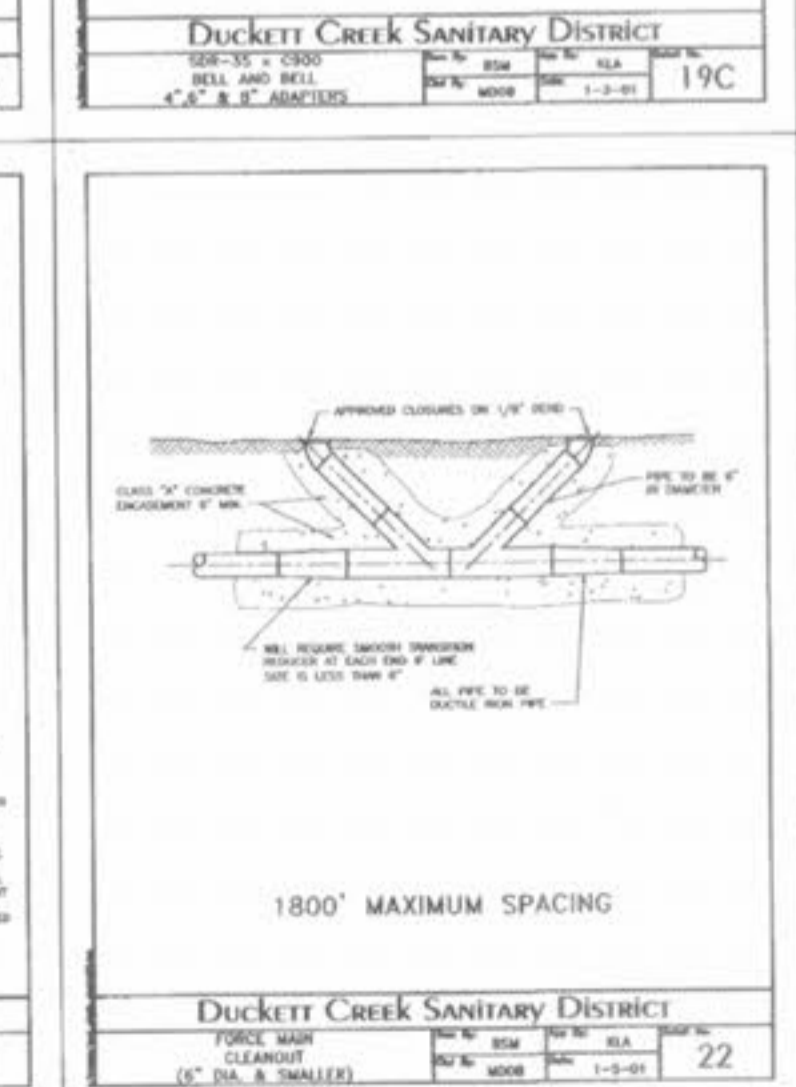
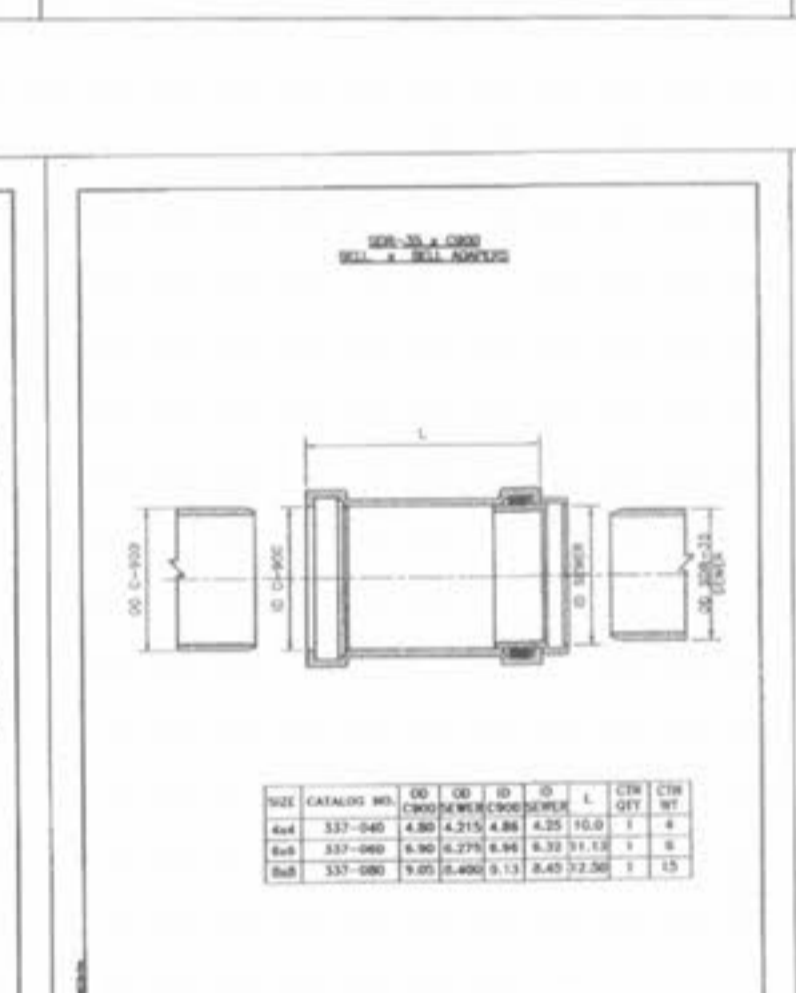
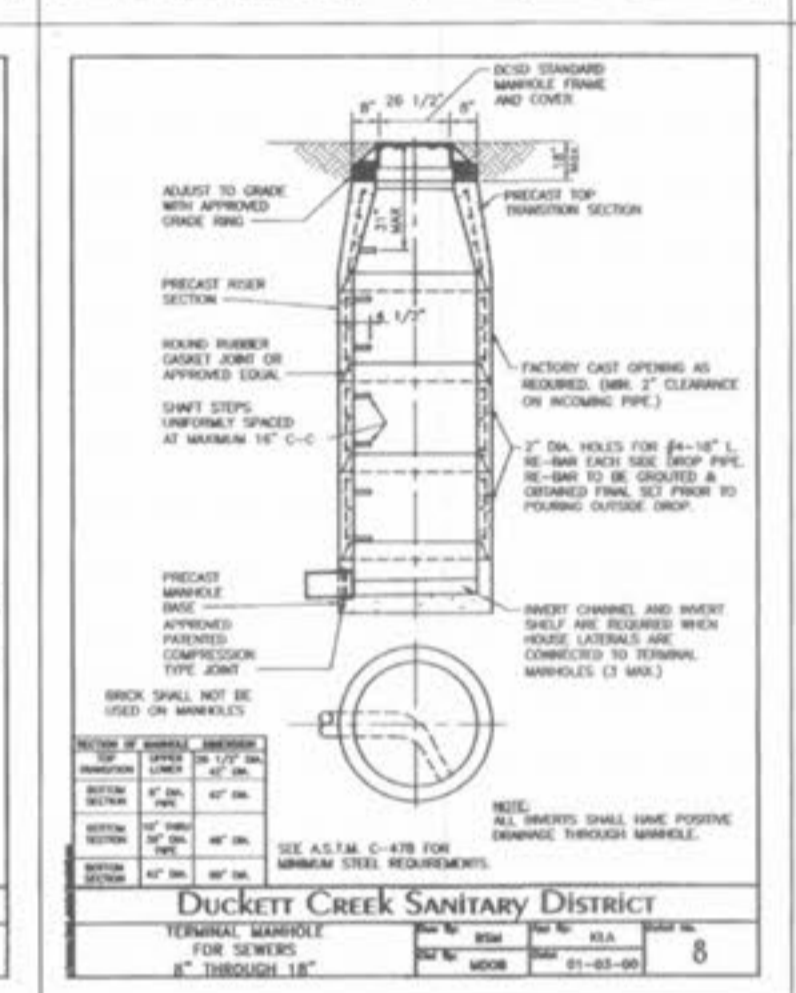
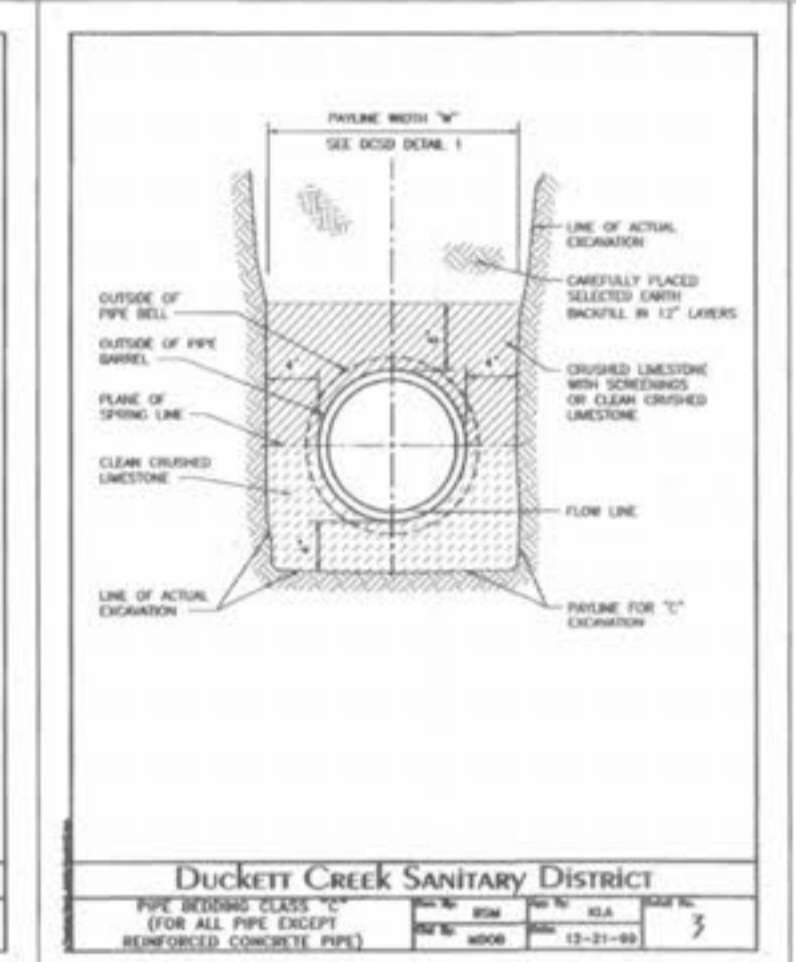
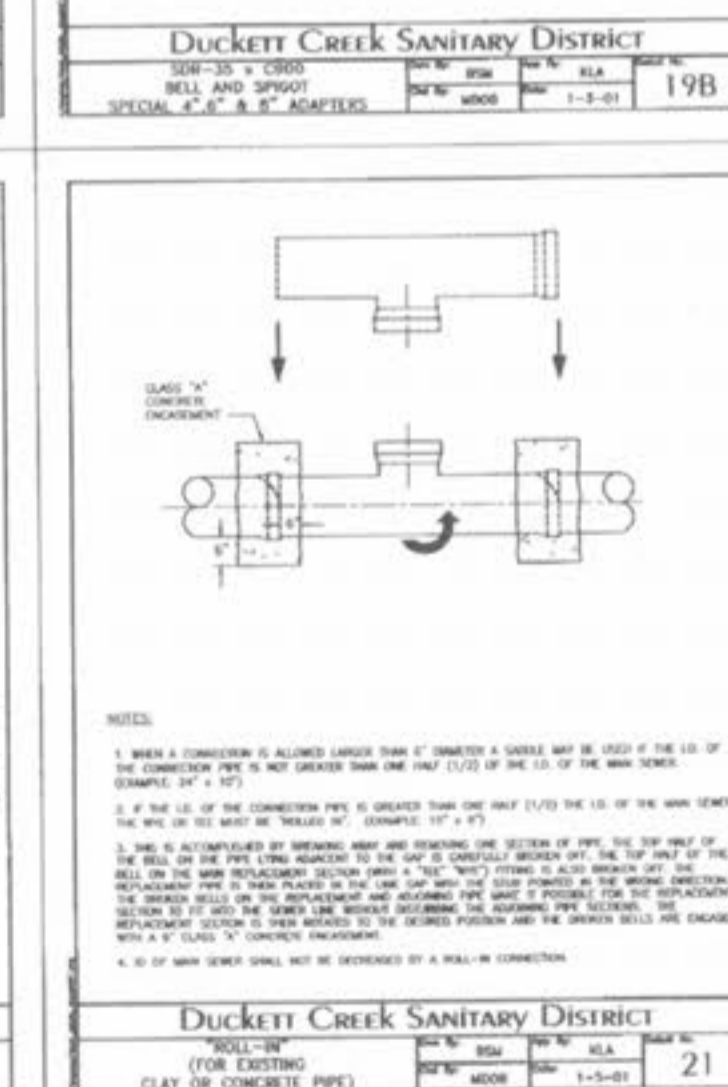
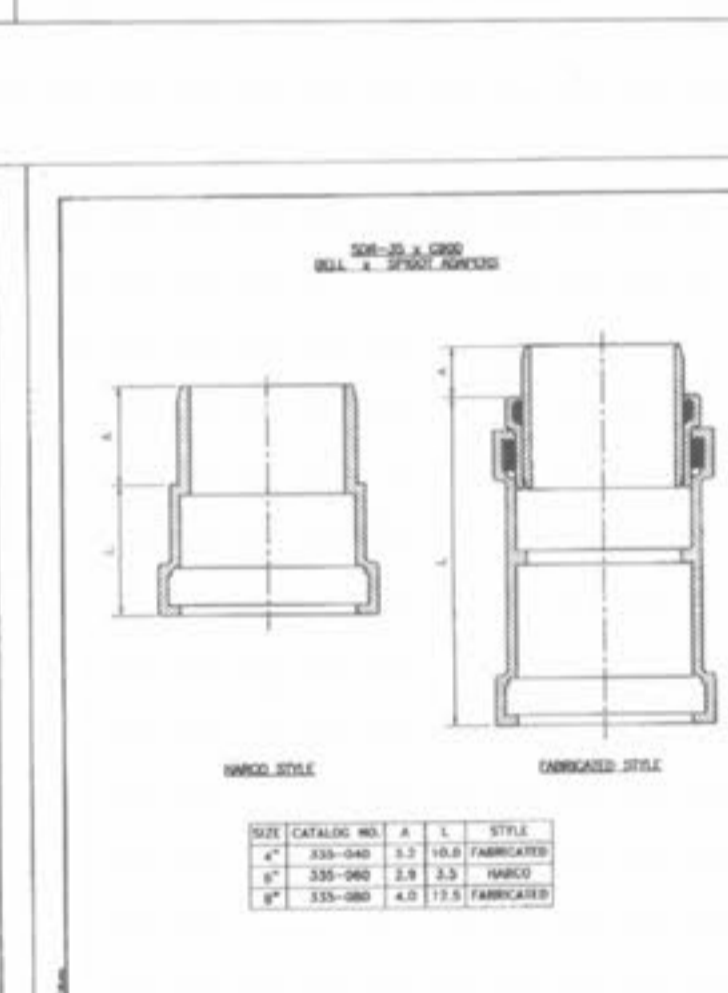
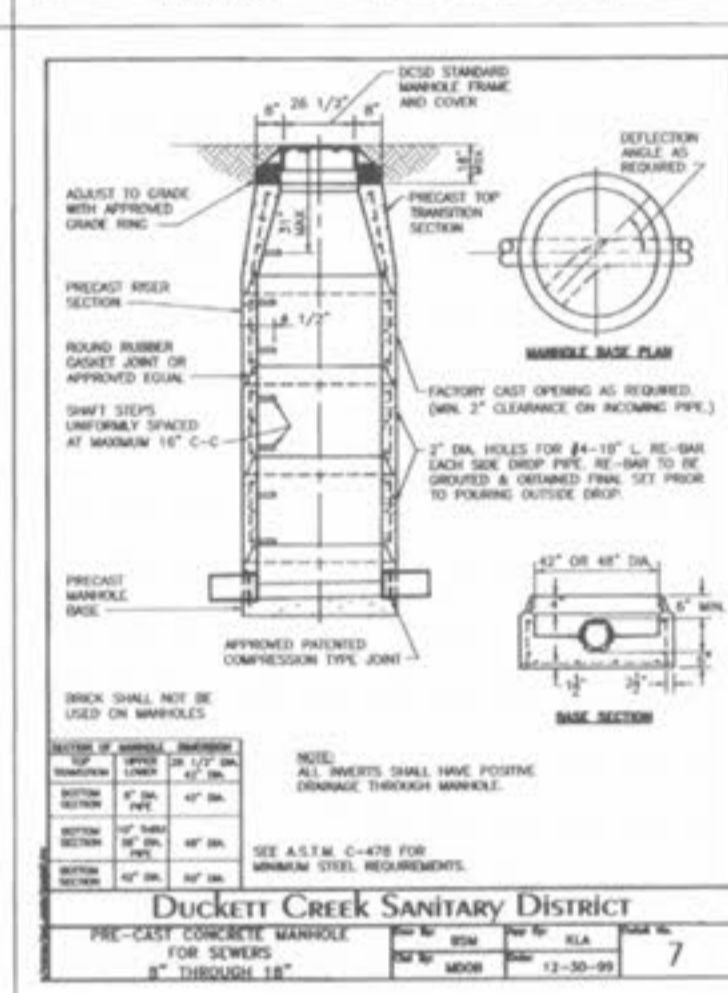
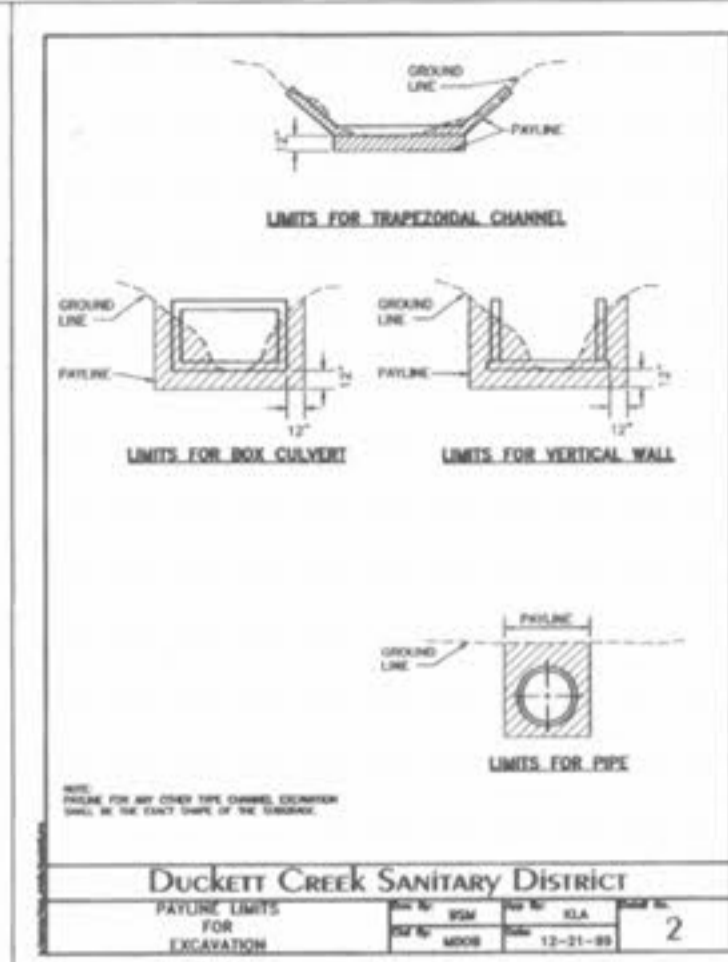
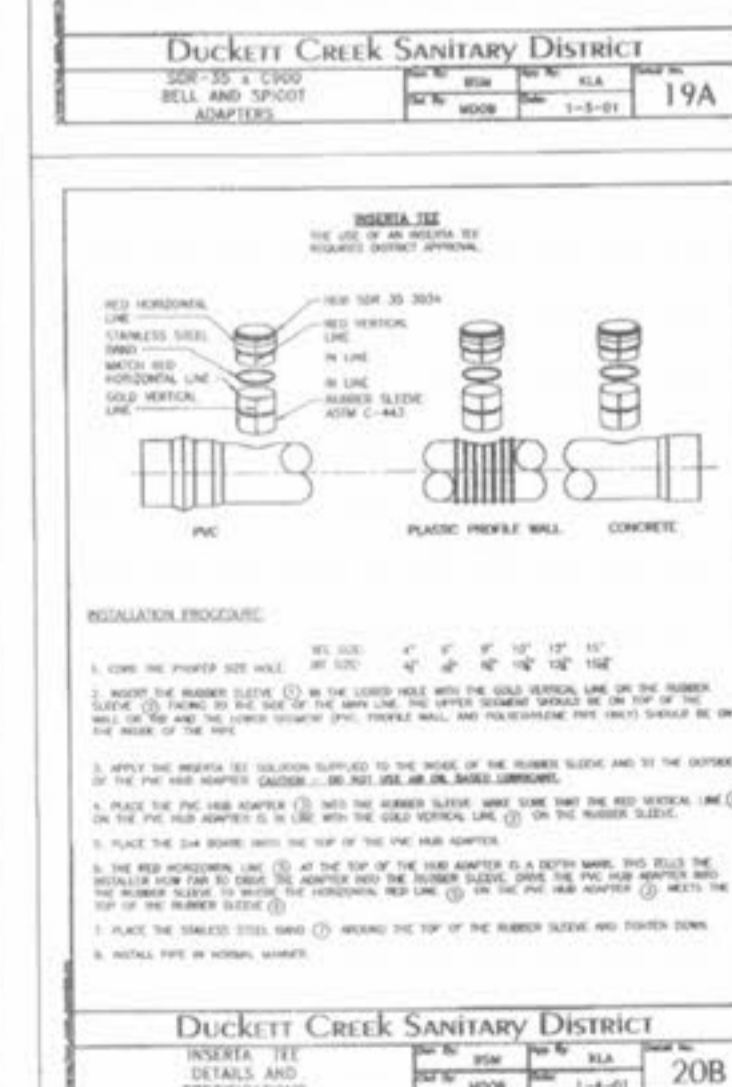
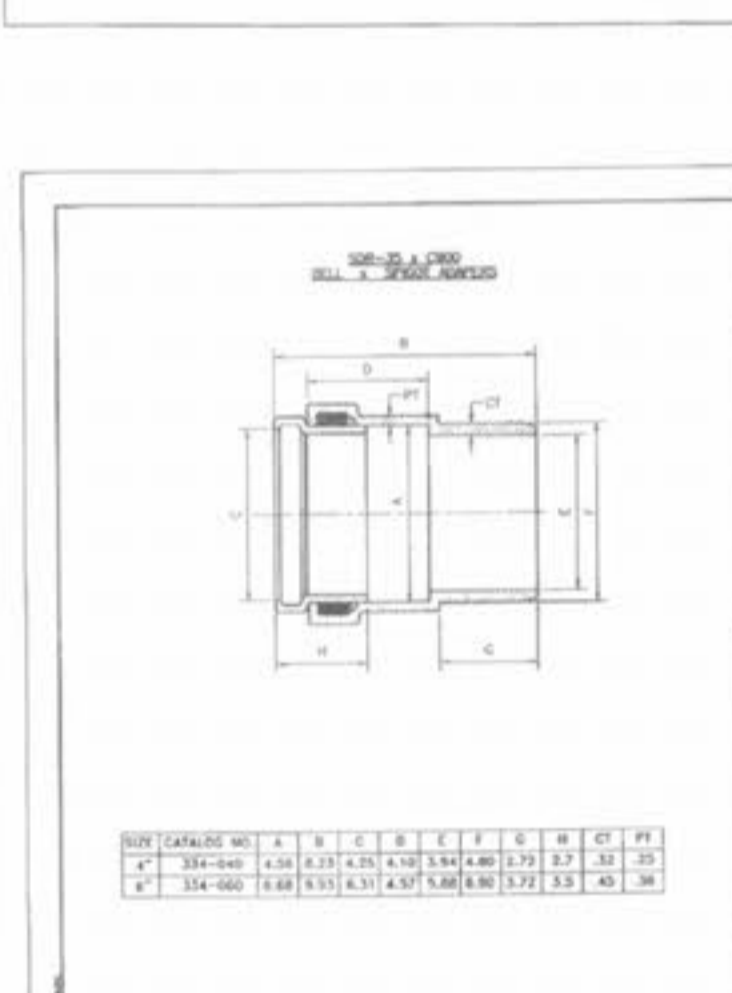
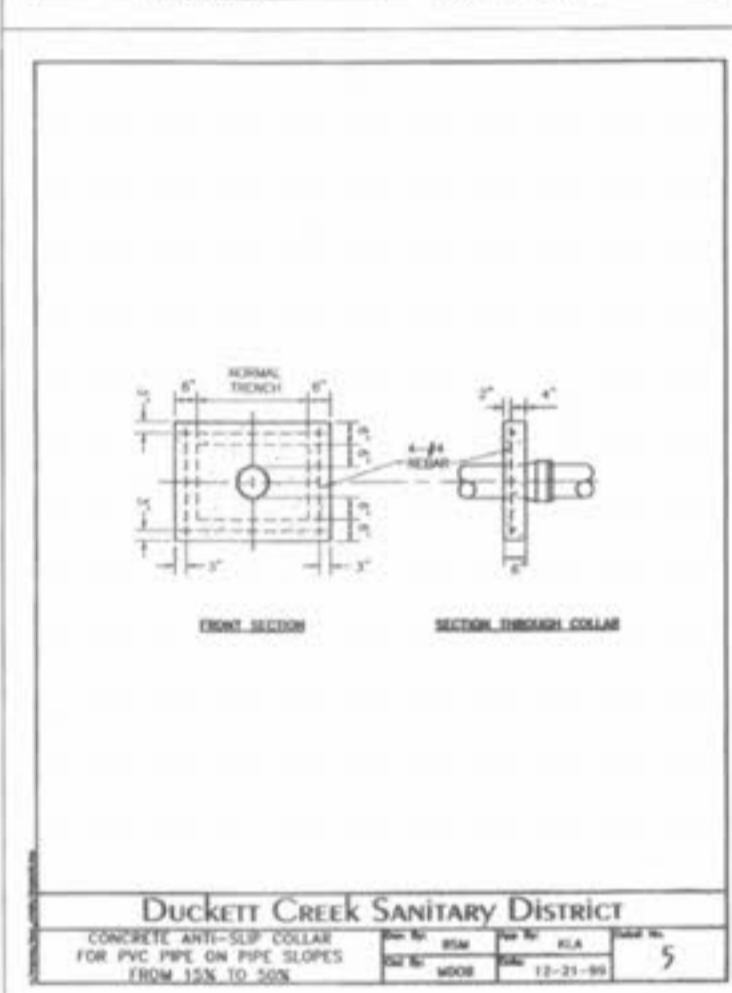
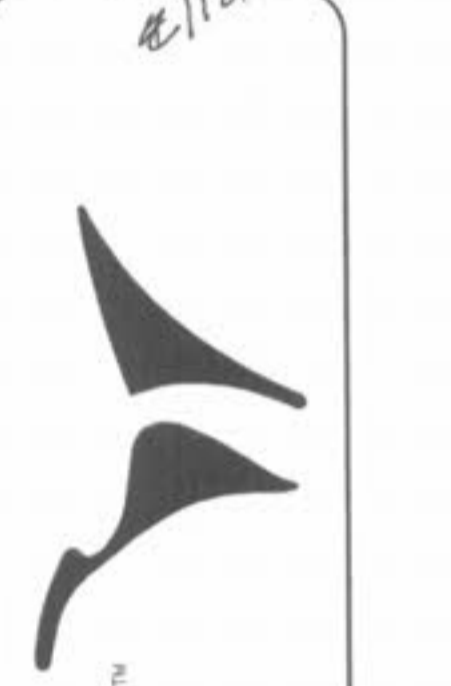

KINGSGATE at WINGHAVEN

CONSTRUCTION DETAIL
Design By: T.B.K.
Drawn By: T.S.J.
Checked By: T.J.M.
11/26/81
10