

ROUND PIPE				HORIZONTAL ELLIPTICAL PIPE			
DIAMETER OF PIPE (INCHES)	WEIGHT PER FOOT (LBS)	PERCENT ENLARGEMENT	PERCENT ENLARGEMENT	DIAMETER OF PIPE (INCHES)	WEIGHT PER FOOT (LBS)	PERCENT ENLARGEMENT	PERCENT ENLARGEMENT
4	3.00	3.00	3.00	4	3.00	3.00	3.00
6	3.00	3.00	3.00	6	3.00	3.00	3.00
8	3.00	3.00	3.00	8	3.00	3.00	3.00
10	3.00	3.00	3.00	10	3.00	3.00	3.00
12	3.00	3.00	3.00	12	3.00	3.00	3.00
14	3.00	3.00	3.00	14	3.00	3.00	3.00
16	3.00	3.00	3.00	16	3.00	3.00	3.00
18	3.00	3.00	3.00	18	3.00	3.00	3.00
20	3.00	3.00	3.00	20	3.00	3.00	3.00
22	3.00	3.00	3.00	22	3.00	3.00	3.00
24	3.00	3.00	3.00	24	3.00	3.00	3.00
26	3.00	3.00	3.00	26	3.00	3.00	3.00
28	3.00	3.00	3.00	28	3.00	3.00	3.00
30	3.00	3.00	3.00	30	3.00	3.00	3.00
32	3.00	3.00	3.00	32	3.00	3.00	3.00
34	3.00	3.00	3.00	34	3.00	3.00	3.00
36	3.00	3.00	3.00	36	3.00	3.00	3.00
38	3.00	3.00	3.00	38	3.00	3.00	3.00
40	3.00	3.00	3.00	40	3.00	3.00	3.00
42	3.00	3.00	3.00	42	3.00	3.00	3.00
44	3.00	3.00	3.00	44	3.00	3.00	3.00
46	3.00	3.00	3.00	46	3.00	3.00	3.00
48	3.00	3.00	3.00	48	3.00	3.00	3.00
50	3.00	3.00	3.00	50	3.00	3.00	3.00
52	3.00	3.00	3.00	52	3.00	3.00	3.00
54	3.00	3.00	3.00	54	3.00	3.00	3.00
56	3.00	3.00	3.00	56	3.00	3.00	3.00
58	3.00	3.00	3.00	58	3.00	3.00	3.00
60	3.00	3.00	3.00	60	3.00	3.00	3.00
62	3.00	3.00	3.00	62	3.00	3.00	3.00
64	3.00	3.00	3.00	64	3.00	3.00	3.00
66	3.00	3.00	3.00	66	3.00	3.00	3.00
68	3.00	3.00	3.00	68	3.00	3.00	3.00
70	3.00	3.00	3.00	70	3.00	3.00	3.00
72	3.00	3.00	3.00	72	3.00	3.00	3.00
74	3.00	3.00	3.00	74	3.00	3.00	3.00
76	3.00	3.00	3.00	76	3.00	3.00	3.00
78	3.00	3.00	3.00	78	3.00	3.00	3.00
80	3.00	3.00	3.00	80	3.00	3.00	3.00
82	3.00	3.00	3.00	82	3.00	3.00	3.00
84	3.00	3.00	3.00	84	3.00	3.00	3.00
86	3.00	3.00	3.00	86	3.00	3.00	3.00
88	3.00	3.00	3.00	88	3.00	3.00	3.00
90	3.00	3.00	3.00	90	3.00	3.00	3.00
92	3.00	3.00	3.00	92	3.00	3.00	3.00
94	3.00	3.00	3.00	94	3.00	3.00	3.00
96	3.00	3.00	3.00	96	3.00	3.00	3.00
98	3.00	3.00	3.00	98	3.00	3.00	3.00
100	3.00	3.00	3.00	100	3.00	3.00	3.00

TABLE 1
PAYLINE WIDTHS OF TRENCH
AND FOOTING QUANTITIES
OF CONCRETE

METROPOLITAN ST. LOUIS SEWER DISTRICT
Standard Details of Sewer Construction
D. W. S. H. & S. O. J. C. K. 1992 SHEET 1

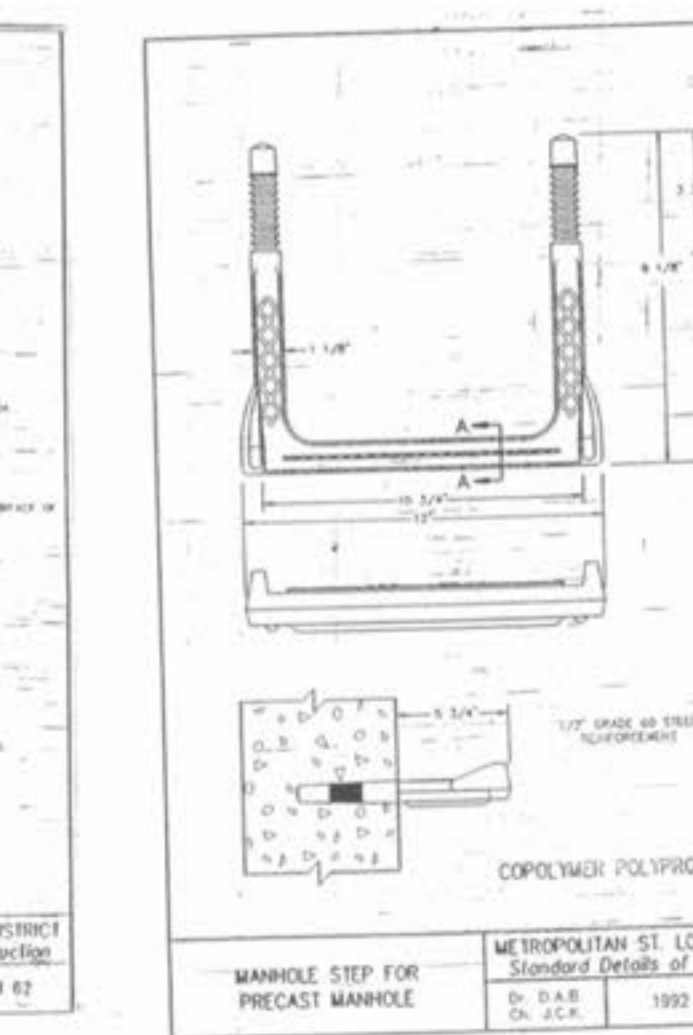
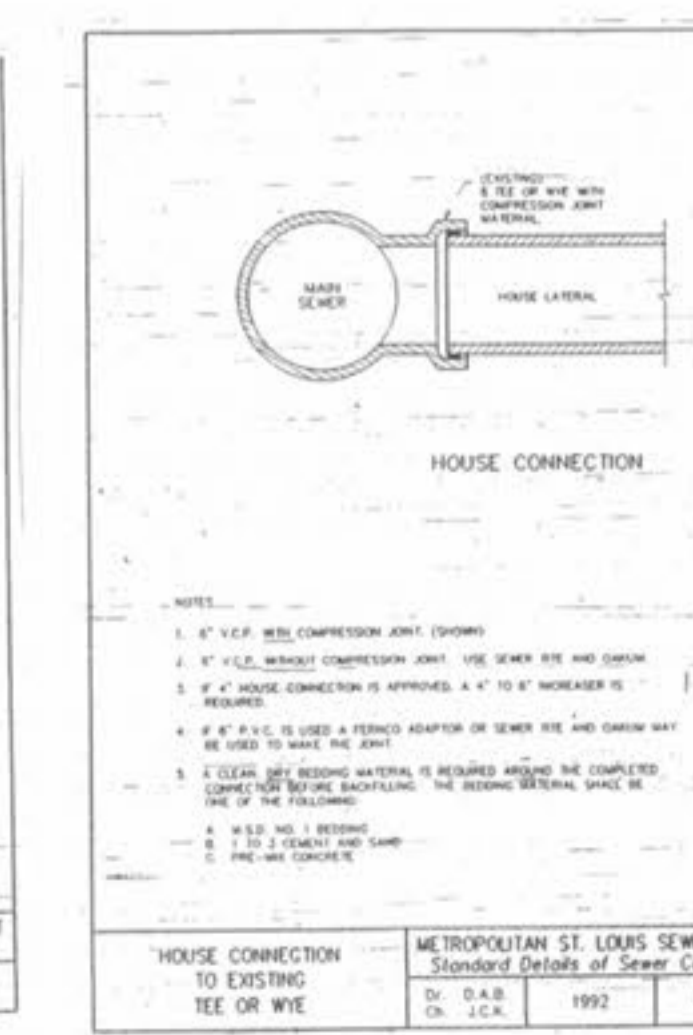
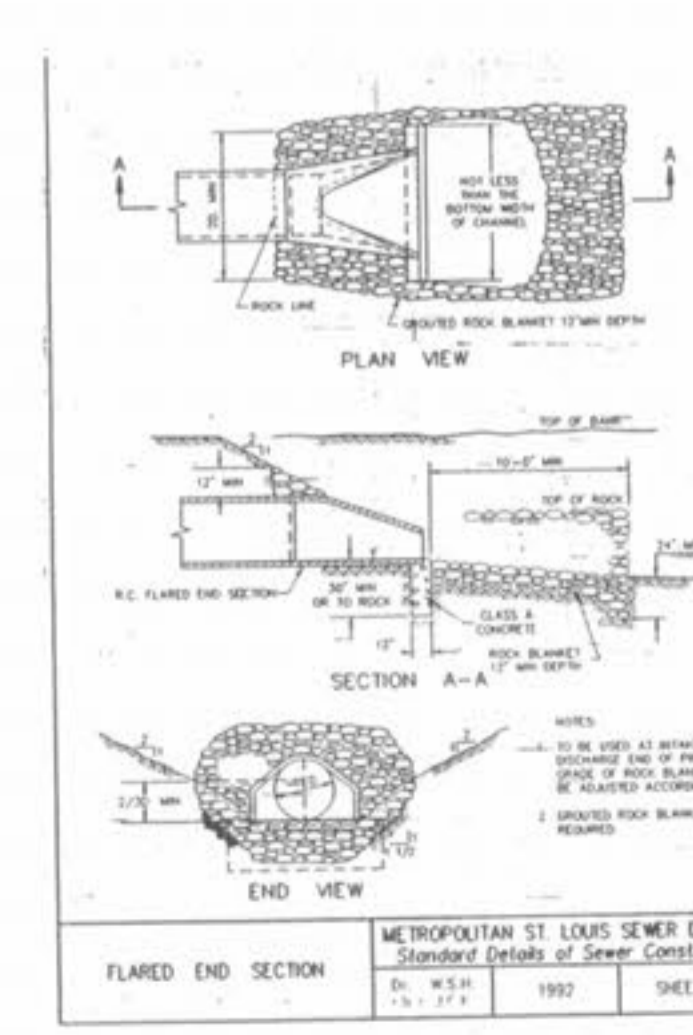
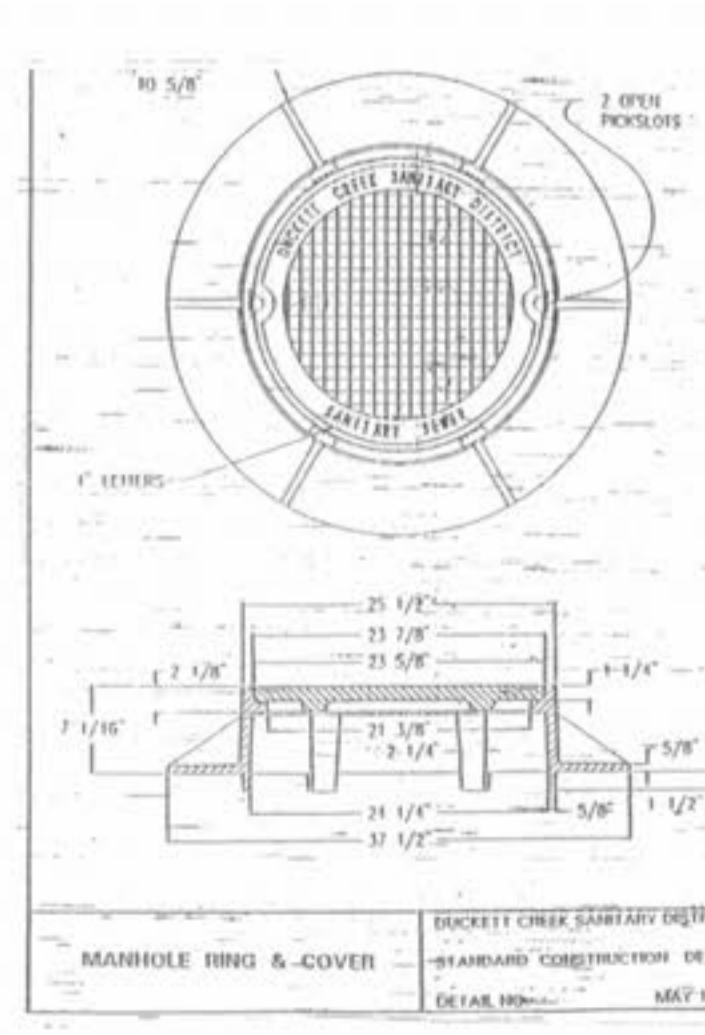
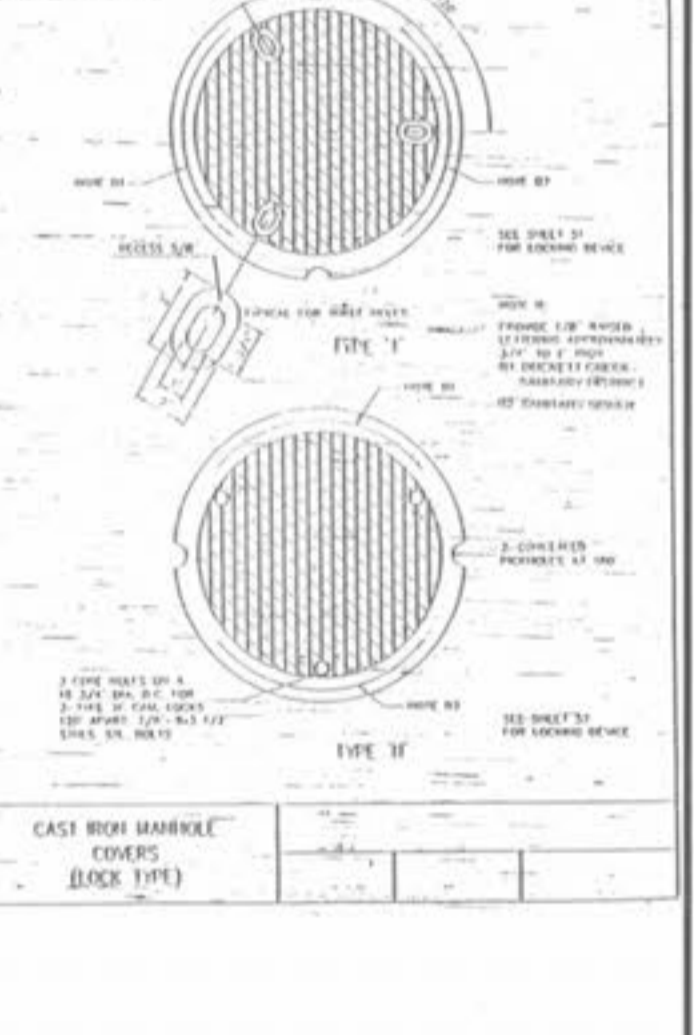
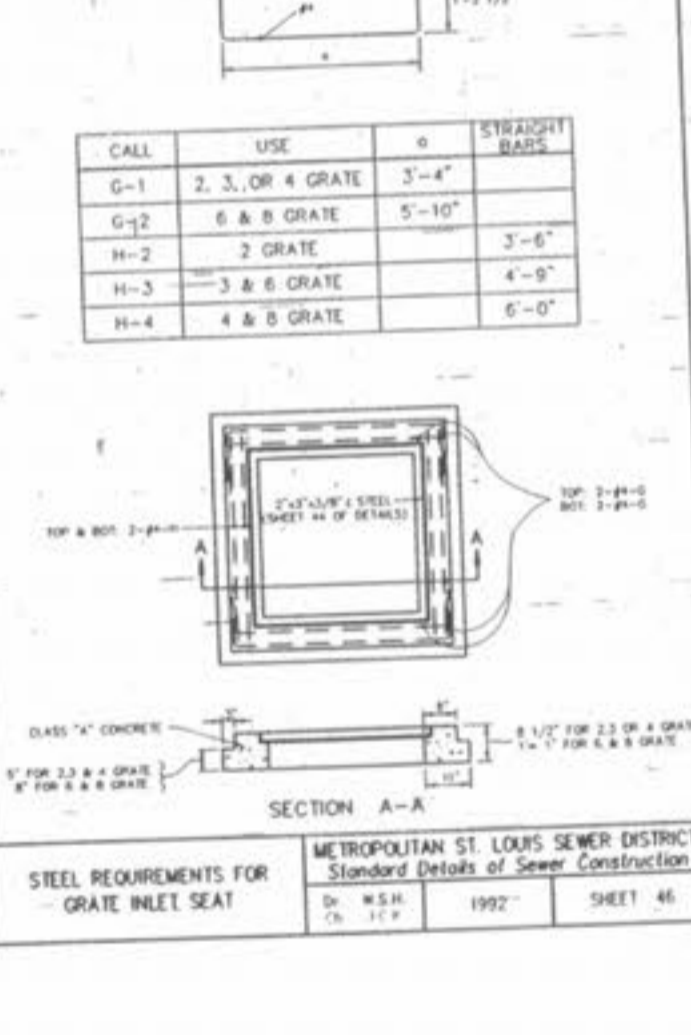
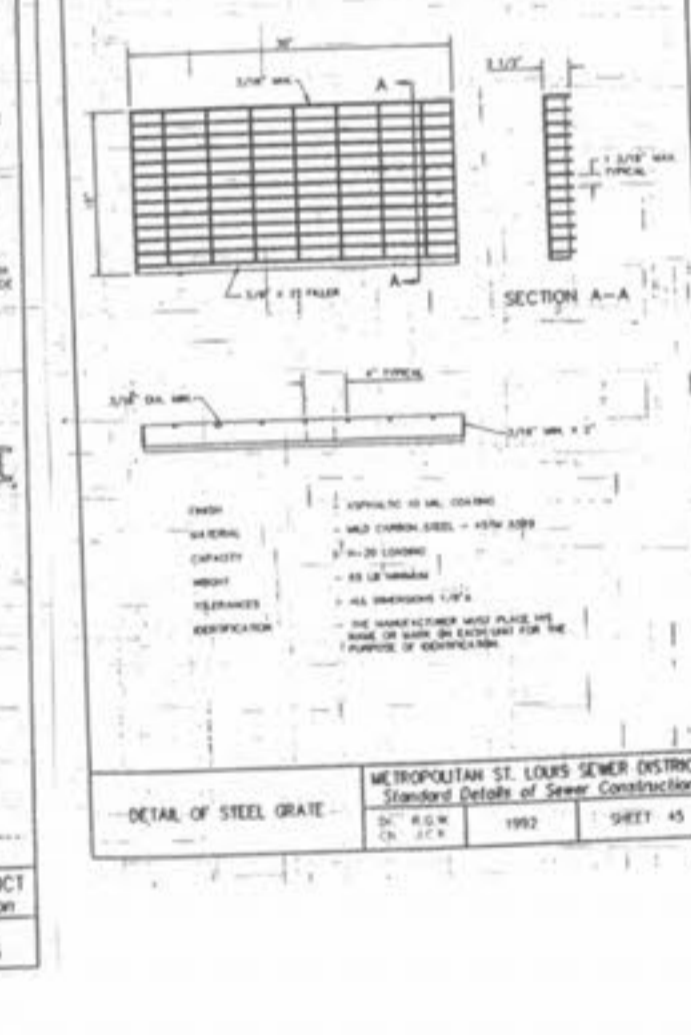
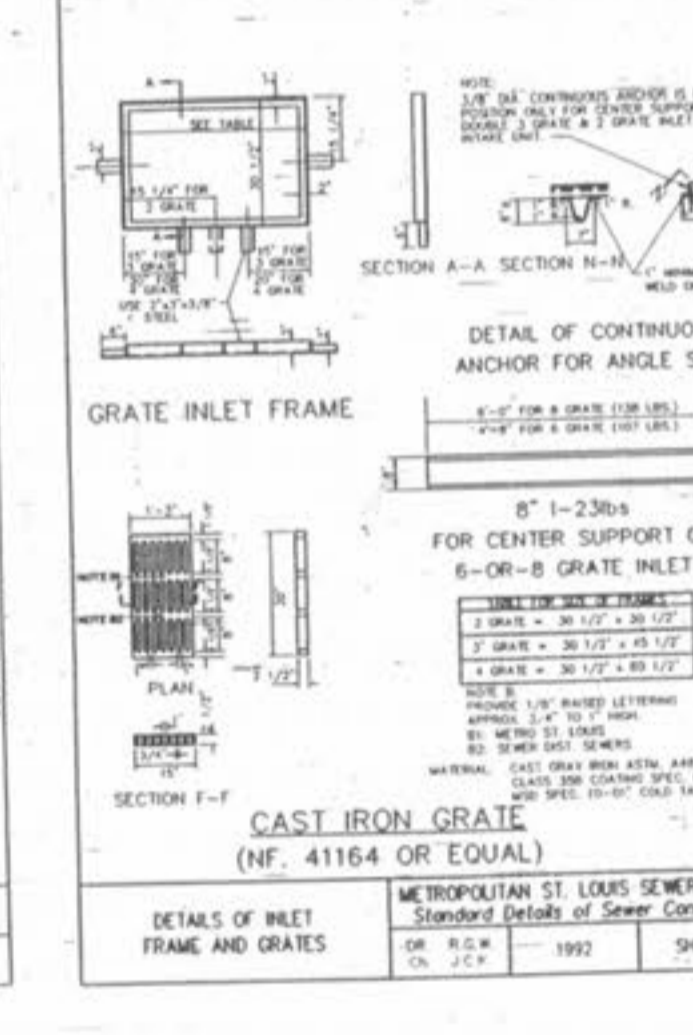
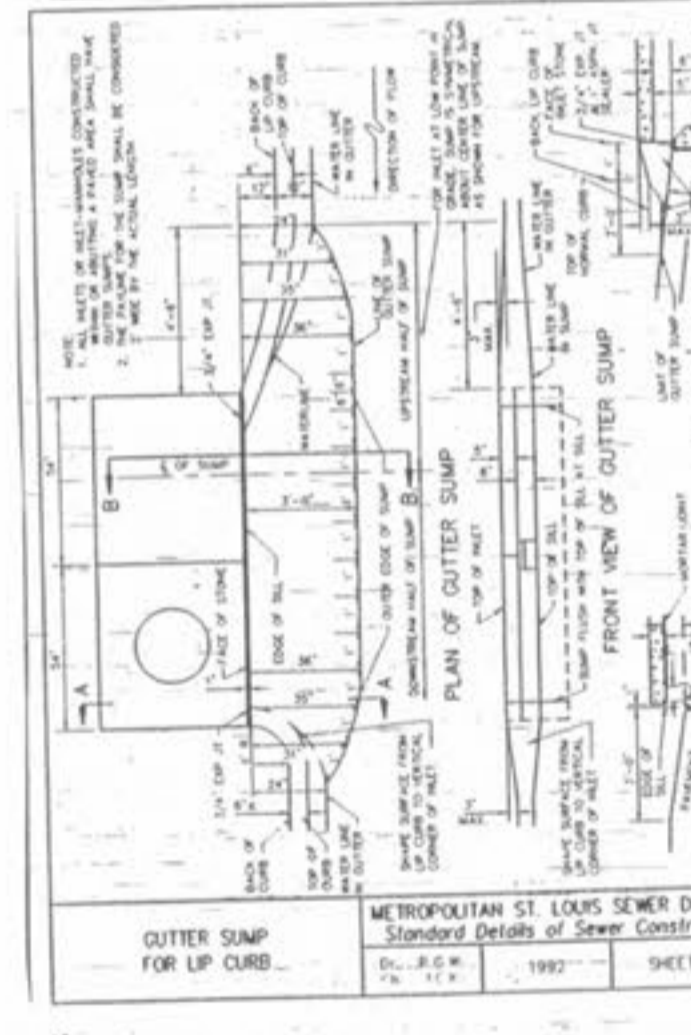
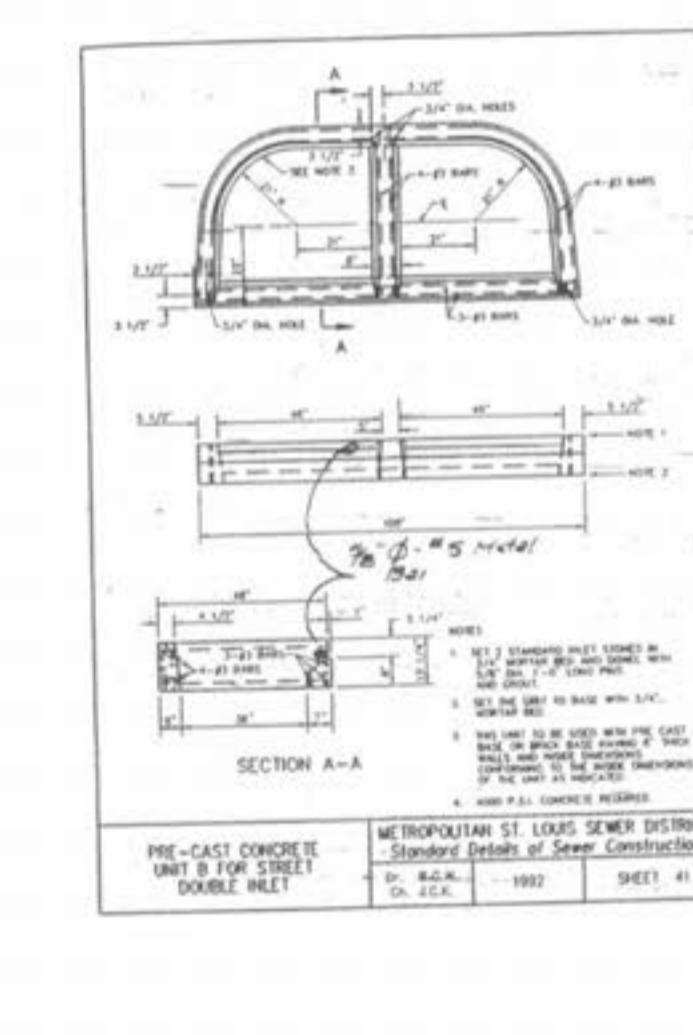
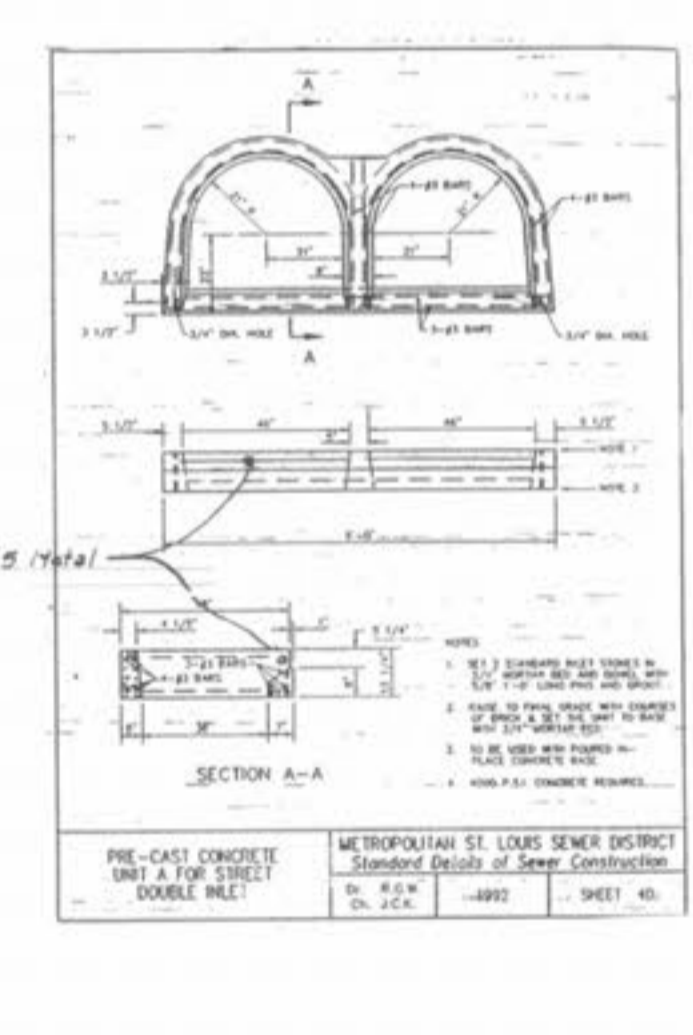
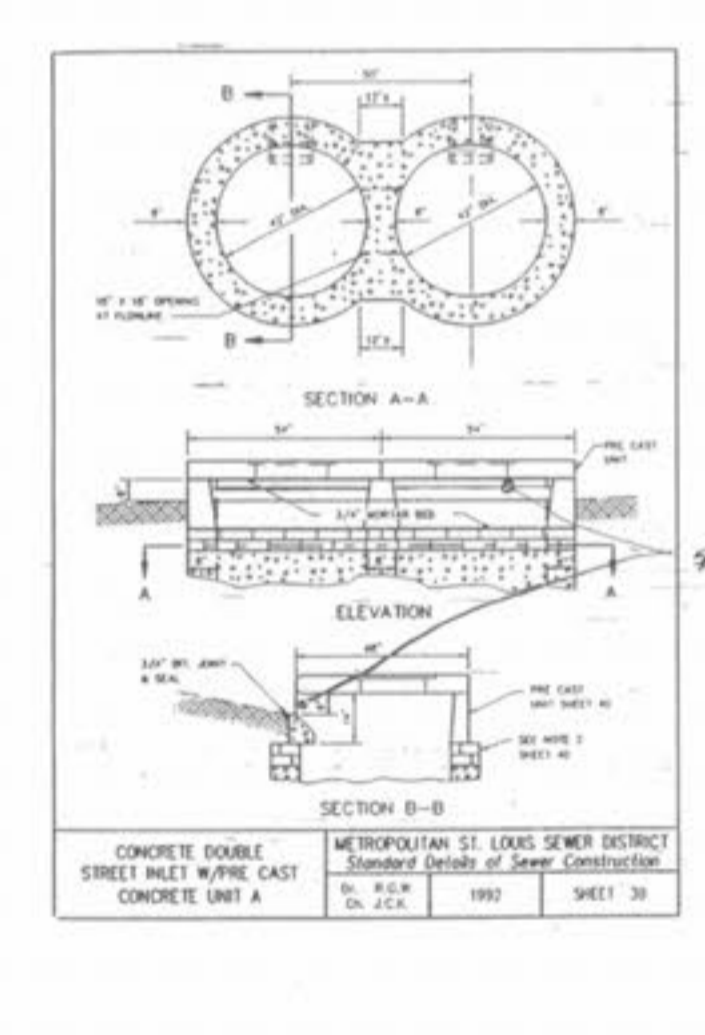
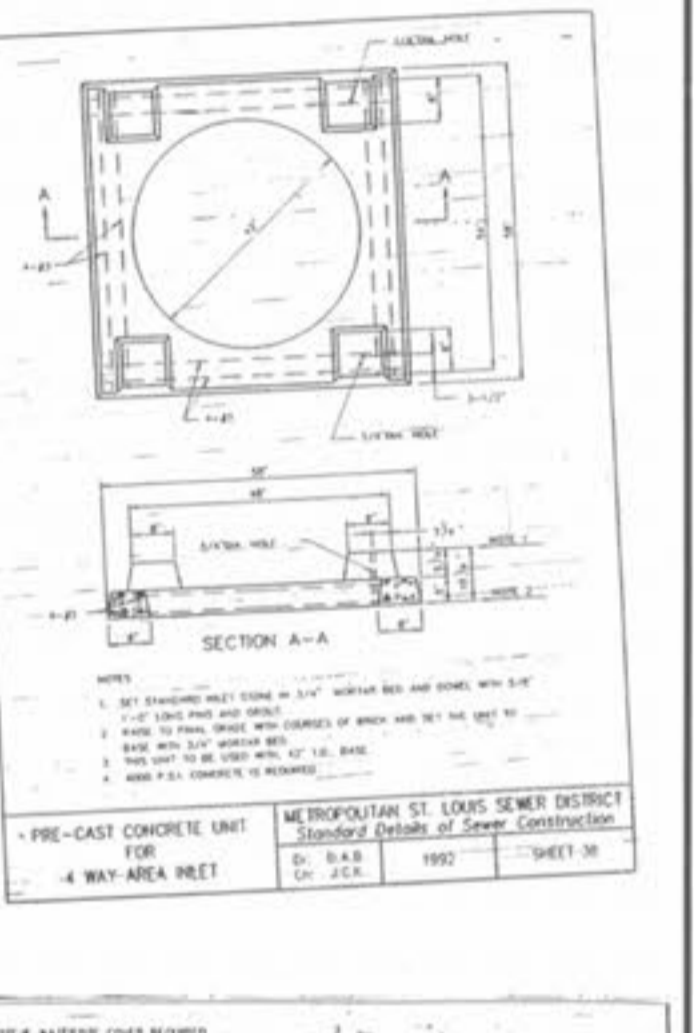
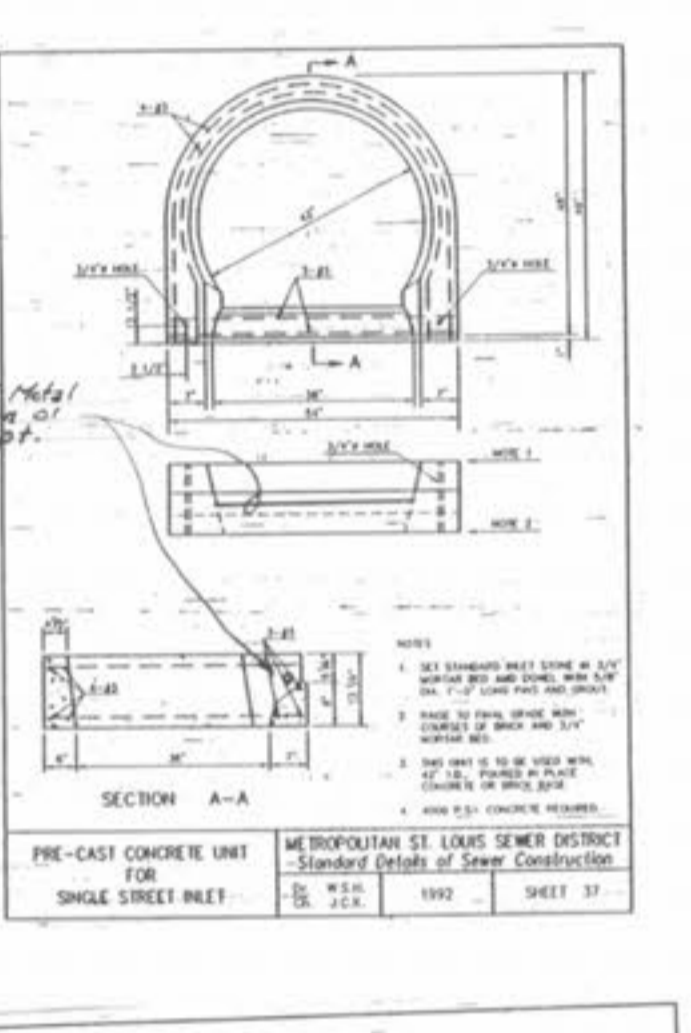
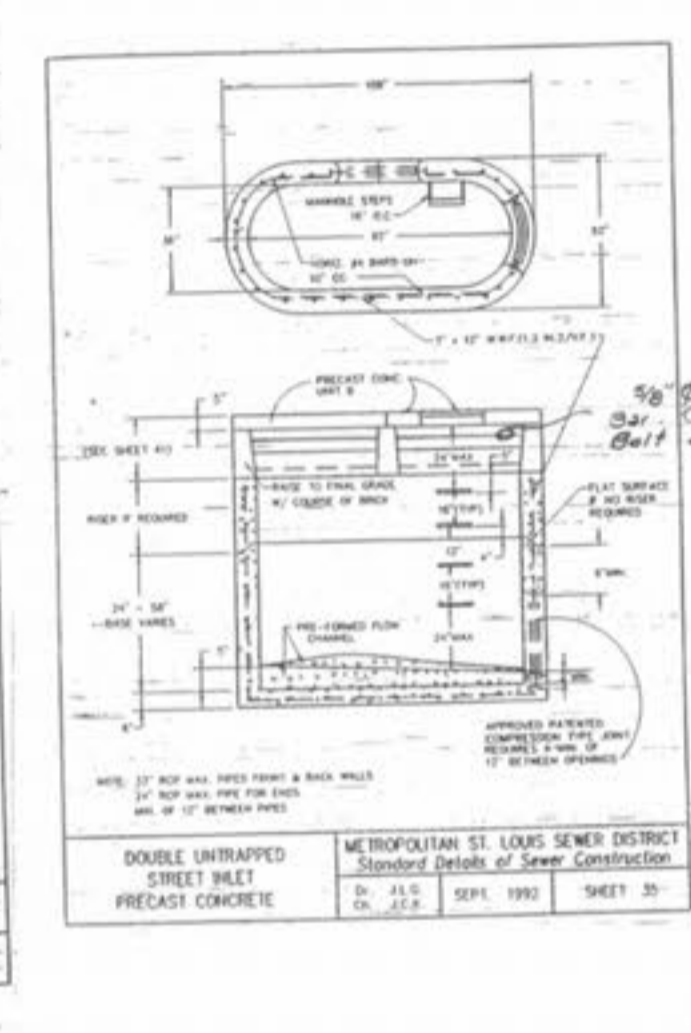
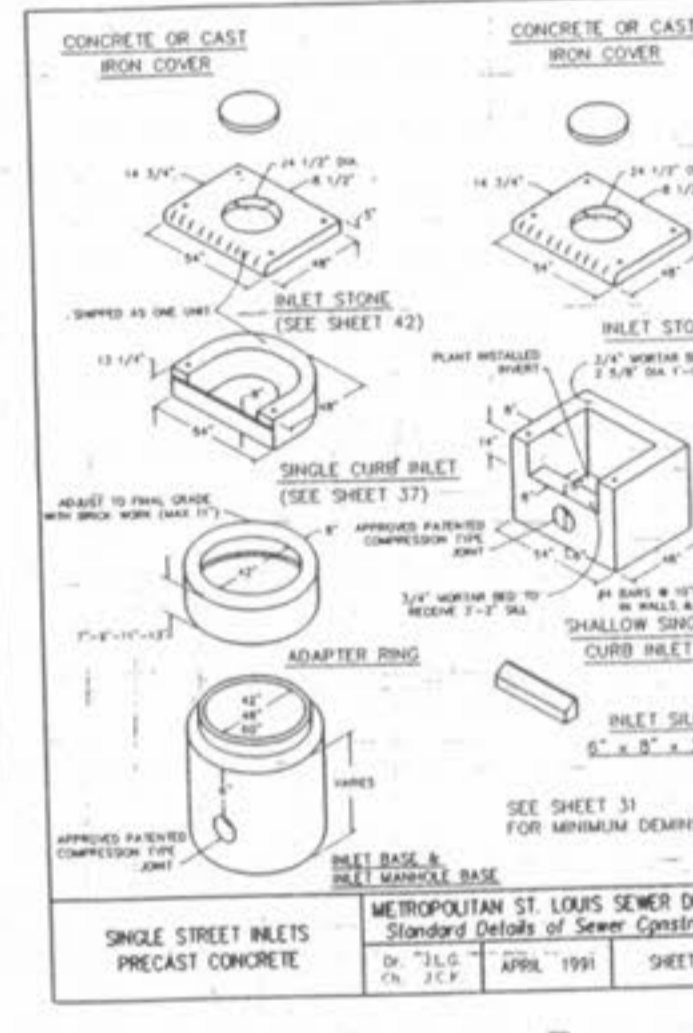
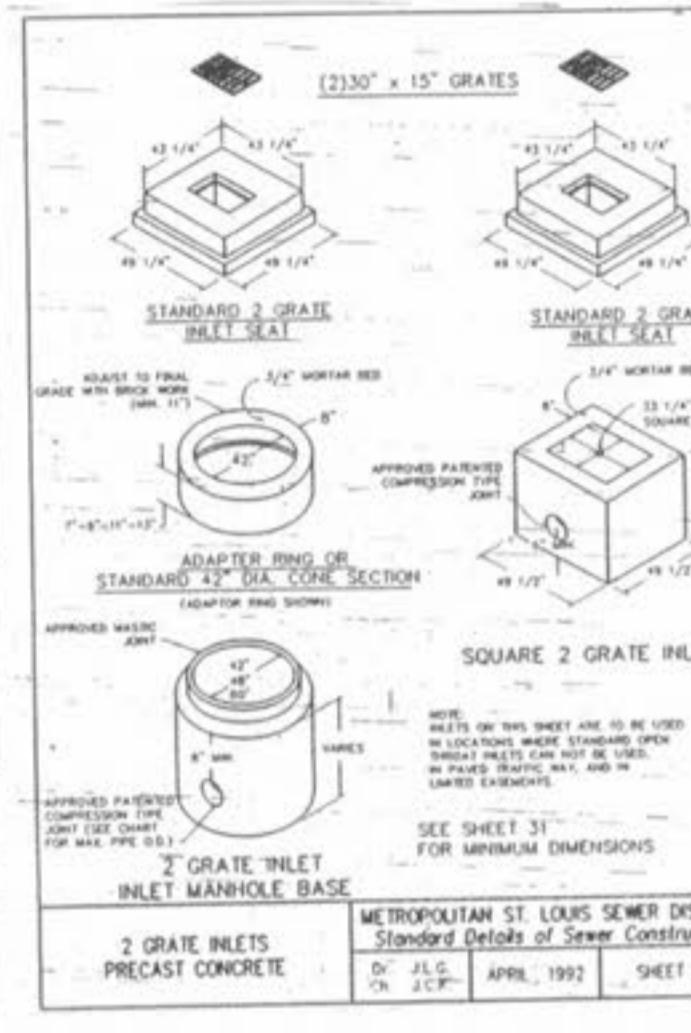
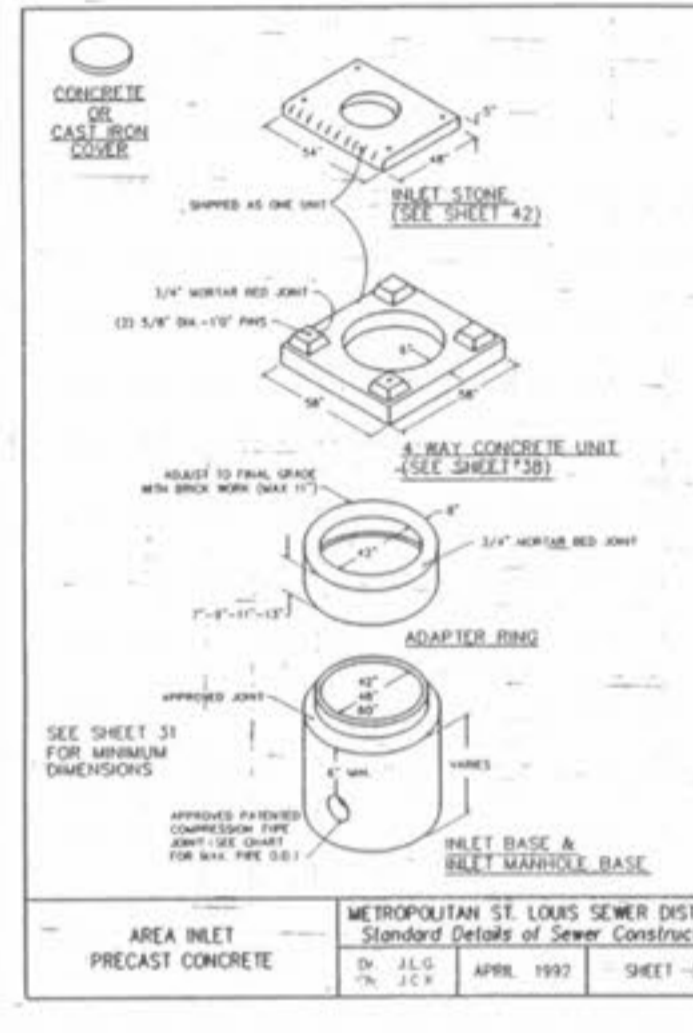
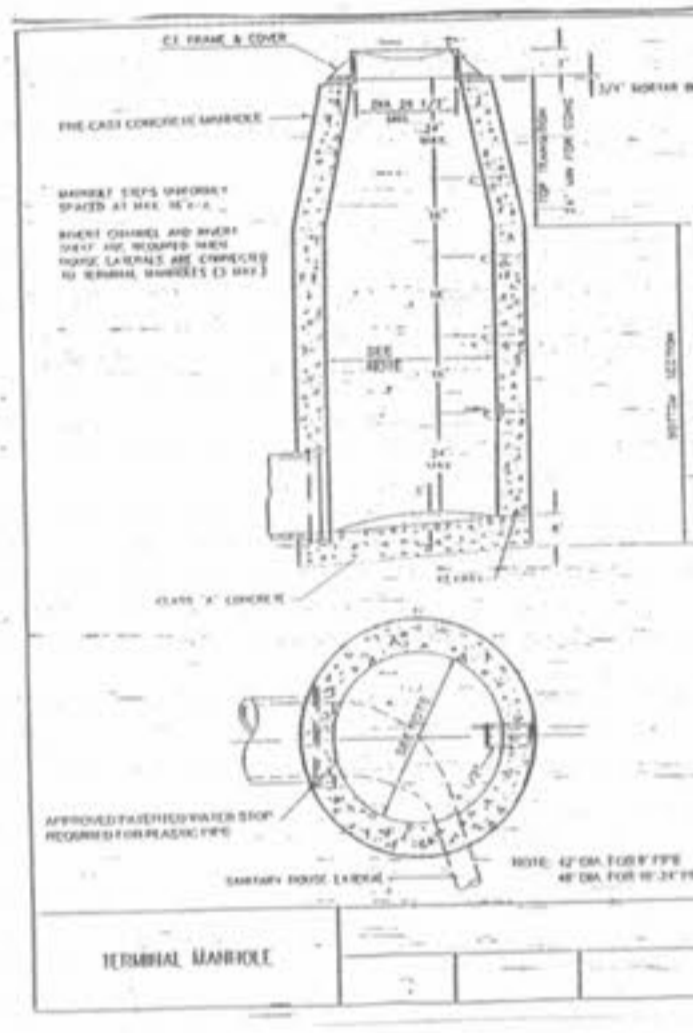
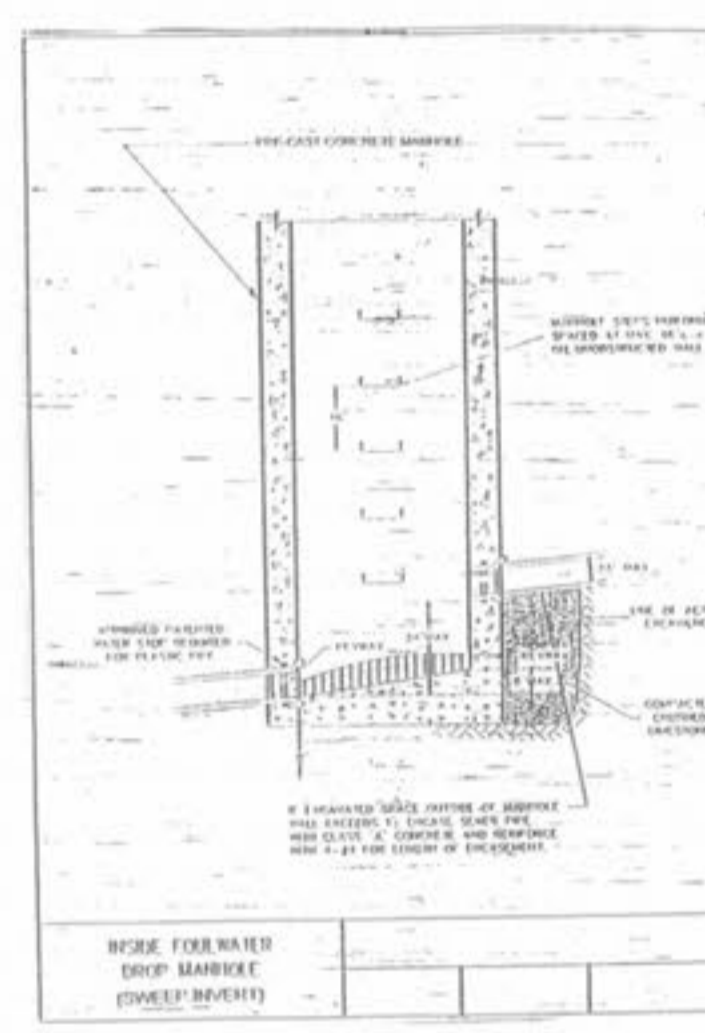
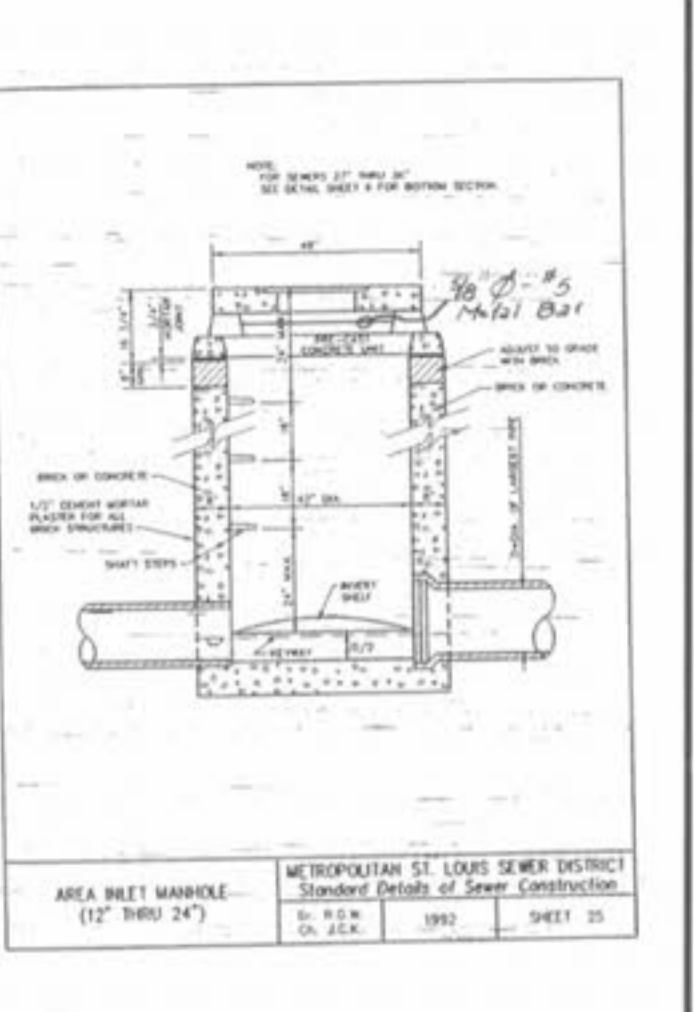
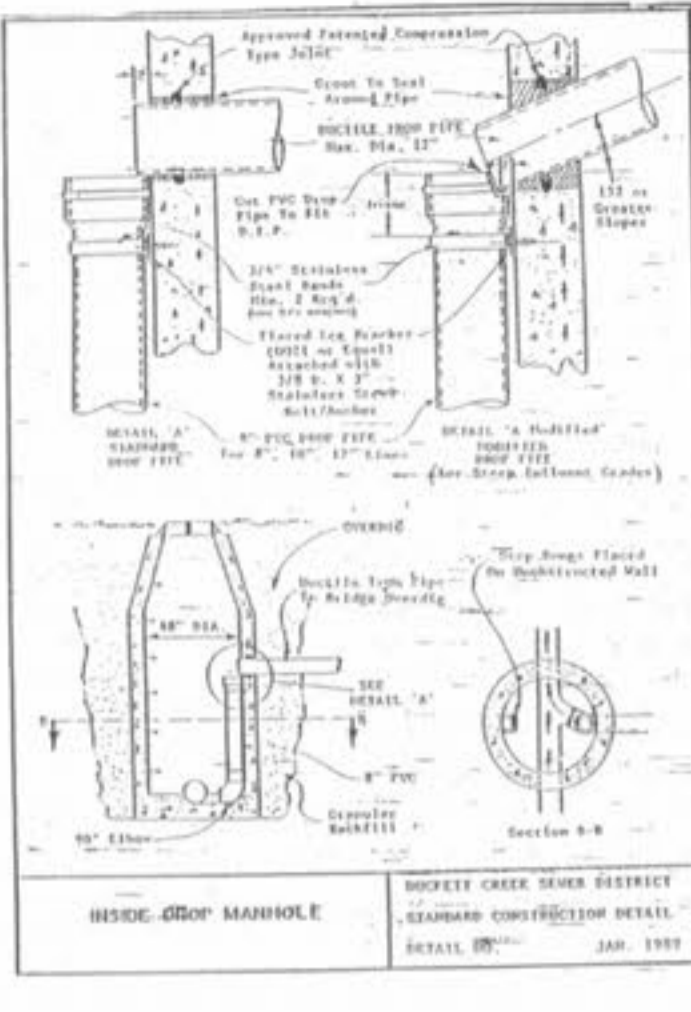
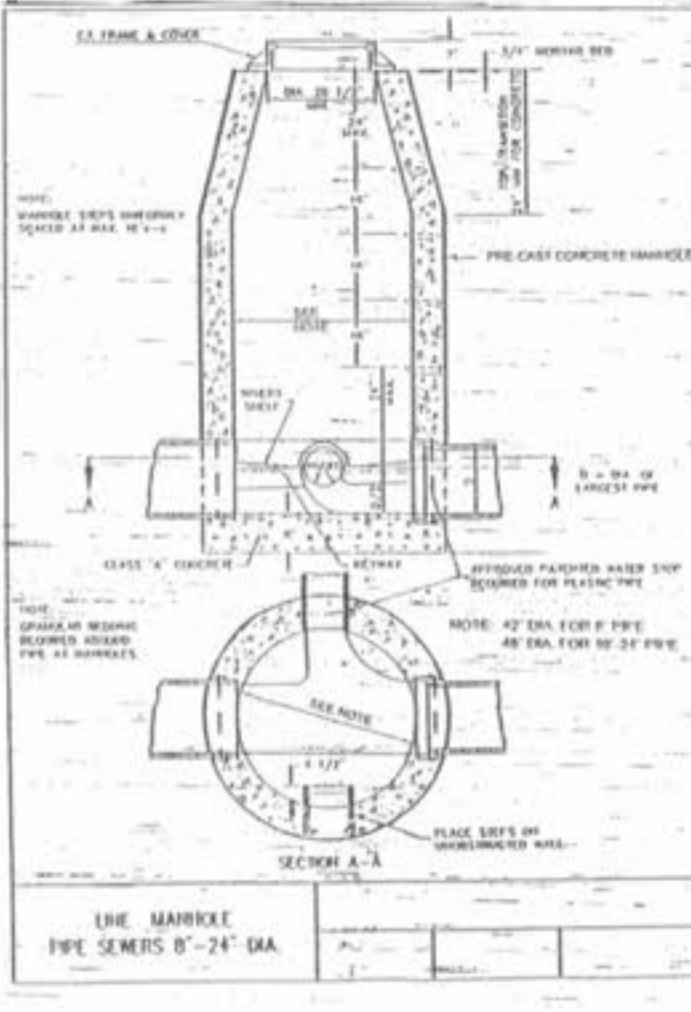
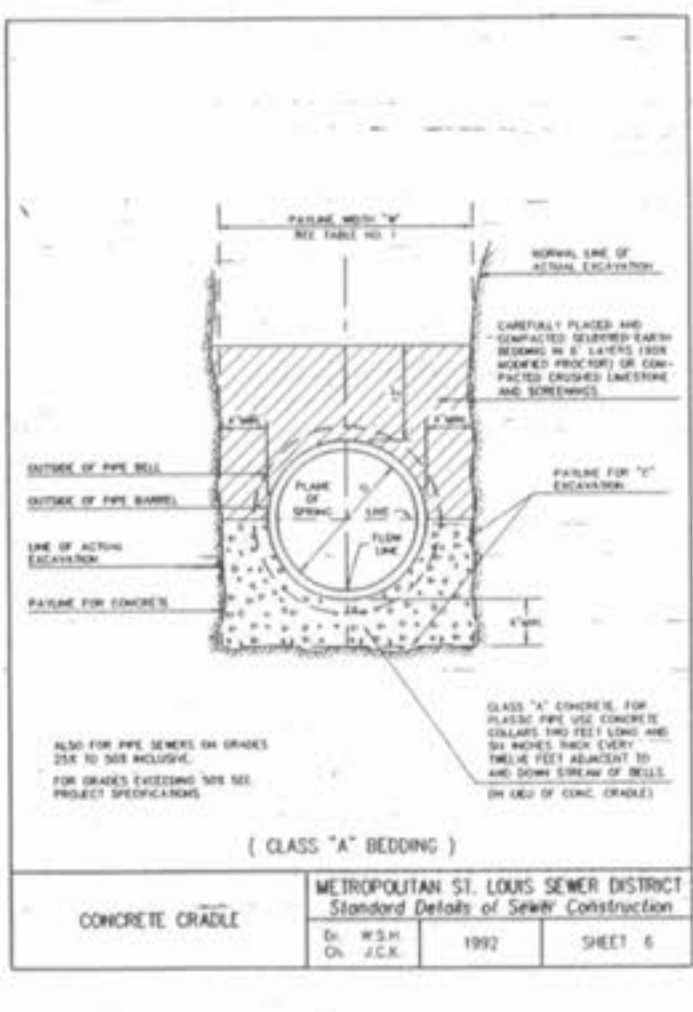
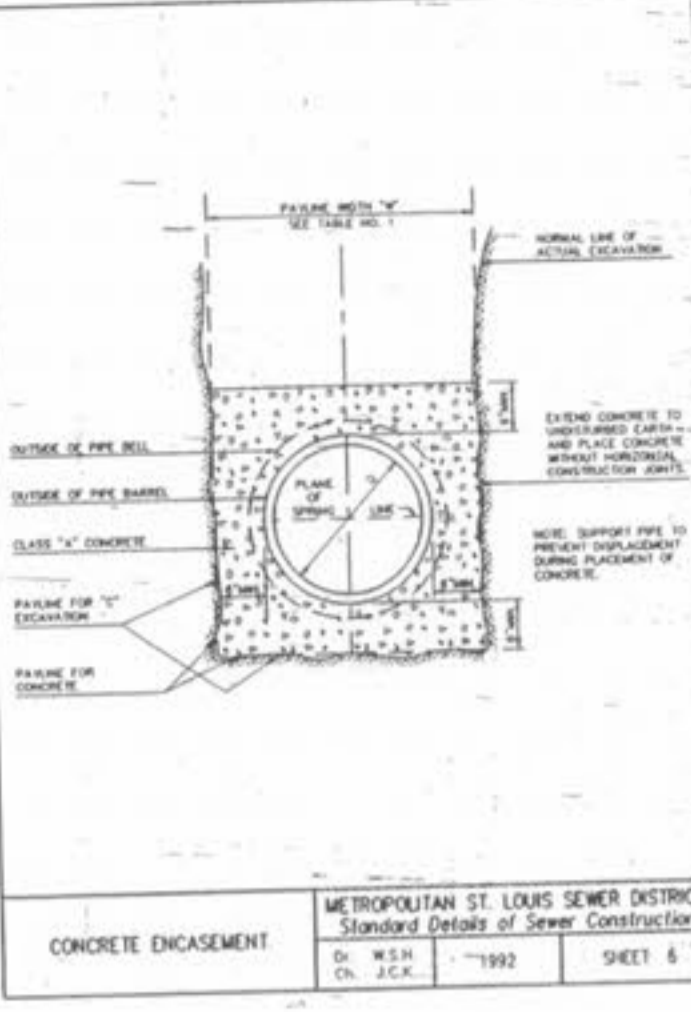
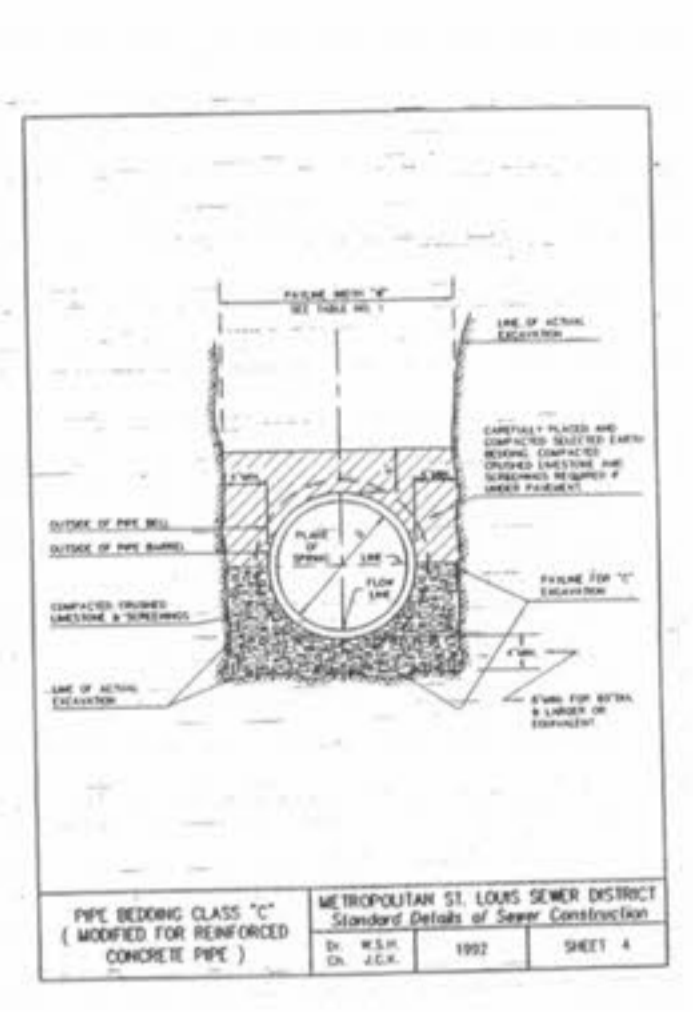
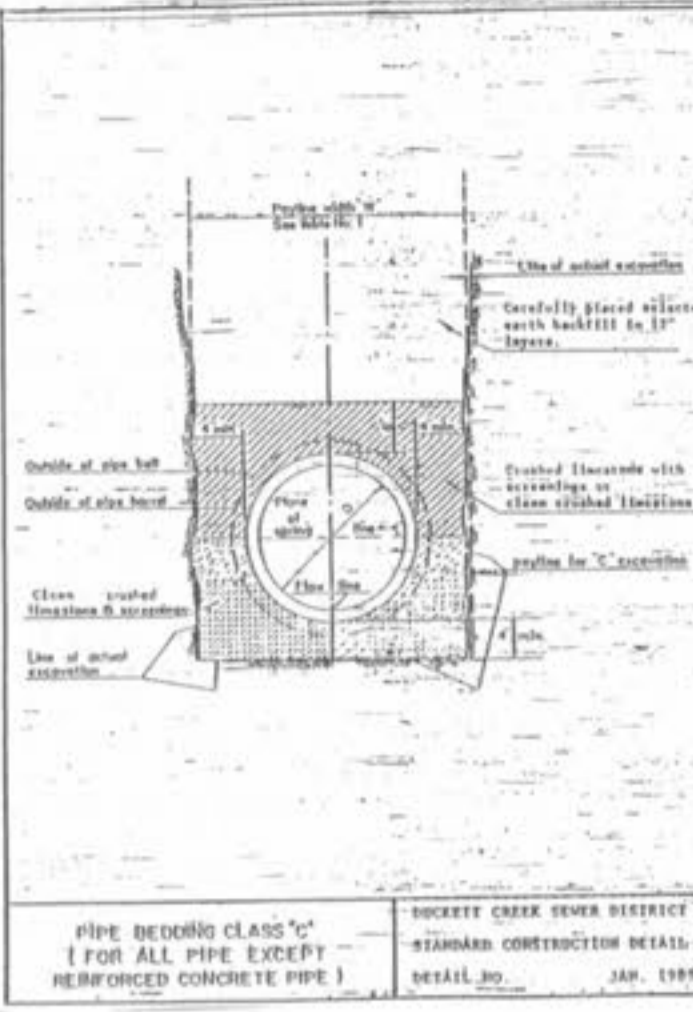

WINGHAVEN
RESIDENTIAL L.L.C.
111 MCRODRE & SON
CORPORATE CENTER DRIVE
ST. LOUIS, MISSOURI 63005
PHONE (314) 531-7200

VOLZ

ELMER ANTHONY KRUISSEL
REGISTERED PROFESSIONAL ENGINEER
STATE OF MISSOURI
NO. 10110
EXPIRES 12/31/97

WINGHAVEN

CONSTRUCTION DETAILS

Design By: R.L.M.
Drawn By: M.E.K.
Checked By: E.A.K.

B-5500