

ROUND PIPE				HORIZONTAL ELLIPTICAL PIPE			
WIDE FLANGE	STANDARD	WIDE FLANGE	STANDARD	WIDE FLANGE	STANDARD	WIDE FLANGE	STANDARD
INCHES	INCHES	INCHES	INCHES	INCHES	INCHES	INCHES	INCHES
1	1.315	1.315	1.315	1.315	1.315	1.315	1.315
2	2.375	2.375	2.375	2.375	2.375	2.375	2.375
3	3.500	3.500	3.500	3.500	3.500	3.500	3.500
4	4.500	4.500	4.500	4.500	4.500	4.500	4.500
6	6.625	6.625	6.625	6.625	6.625	6.625	6.625
8	8.625	8.625	8.625	8.625	8.625	8.625	8.625
10	10.750	10.750	10.750	10.750	10.750	10.750	10.750
12	12.750	12.750	12.750	12.750	12.750	12.750	12.750
15	15.750	15.750	15.750	15.750	15.750	15.750	15.750
18	18.750	18.750	18.750	18.750	18.750	18.750	18.750
20	20.750	20.750	20.750	20.750	20.750	20.750	20.750
24	24.750	24.750	24.750	24.750	24.750	24.750	24.750
30	30.750	30.750	30.750	30.750	30.750	30.750	30.750
36	36.750	36.750	36.750	36.750	36.750	36.750	36.750
42	42.750	42.750	42.750	42.750	42.750	42.750	42.750
48	48.750	48.750	48.750	48.750	48.750	48.750	48.750
54	54.750	54.750	54.750	54.750	54.750	54.750	54.750
60	60.750	60.750	60.750	60.750	60.750	60.750	60.750
66	66.750	66.750	66.750	66.750	66.750	66.750	66.750
72	72.750	72.750	72.750	72.750	72.750	72.750	72.750
78	78.750	78.750	78.750	78.750	78.750	78.750	78.750
84	84.750	84.750	84.750	84.750	84.750	84.750	84.750
90	90.750	90.750	90.750	90.750	90.750	90.750	90.750
96	96.750	96.750	96.750	96.750	96.750	96.750	96.750
102	102.750	102.750	102.750	102.750	102.750	102.750	102.750
108	108.750	108.750	108.750	108.750	108.750	108.750	108.750
114	114.750	114.750	114.750	114.750	114.750	114.750	114.750
120	120.750	120.750	120.750	120.750	120.750	120.750	120.750
126	126.750	126.750	126.750	126.750	126.750	126.750	126.750
132	132.750	132.750	132.750	132.750	132.750	132.750	132.750
138	138.750	138.750	138.750	138.750	138.750	138.750	138.750
144	144.750	144.750	144.750	144.750	144.750	144.750	144.750
150	150.750	150.750	150.750	150.750	150.750	150.750	150.750
156	156.750	156.750	156.750	156.750	156.750	156.750	156.750
162	162.750	162.750	162.750	162.750	162.750	162.750	162.750
168	168.750	168.750	168.750	168.750	168.750	168.750	168.750
174	174.750	174.750	174.750	174.750	174.750	174.750	174.750
180	180.750	180.750	180.750	180.750	180.750	180.750	180.750
186	186.750	186.750	186.750	186.750	186.750	186.750	186.750
192	192.750	192.750	192.750	192.750	192.750	192.750	192.750
198	198.750	198.750	198.750	198.750	198.750	198.750	198.750
204	204.750	204.750	204.750	204.750	204.750	204.750	204.750
210	210.750	210.750	210.750	210.750	210.750	210.750	210.750
216	216.750	216.750	216.750	216.750	216.750	216.750	216.750
222	222.750	222.750	222.750	222.750	222.750	222.750	222.750
228	228.750	228.750	228.750	228.750	228.750	228.750	228.750
234	234.750	234.750	234.750	234.750	234.750	234.750	234.750
240	240.750	240.750	240.750	240.750	240.750	240.750	240.750
246	246.750	246.750	246.750	246.750	246.750	246.750	246.750
252	252.750	252.750	252.750	252.750	252.750	252.750	252.750
258	258.750	258.750	258.750	258.750	258.750	258.750	258.750
264	264.750	264.750	264.750	264.750	264.750	264.750	264.750
270	270.750	270.750	270.750	270.750	270.750	270.750	270.750
276	276.750	276.750	276.750	276.750	276.750	276.750	276.750
282	282.750	282.750	282.750	282.750	282.750	282.750	282.750
288	288.750	288.750	288.750	288.750	288.750	288.750	288.750
294	294.750	294.750	294.750	294.750	294.750	294.750	294.750
300	300.750	300.750	300.750	300.750	300.750	300.750	300.750

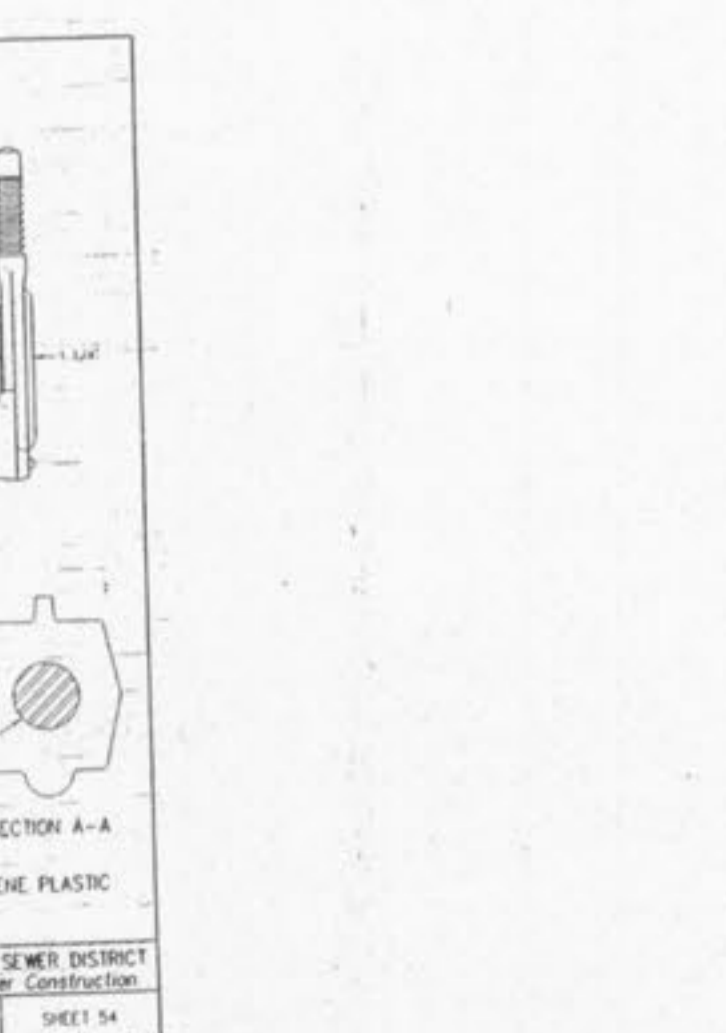
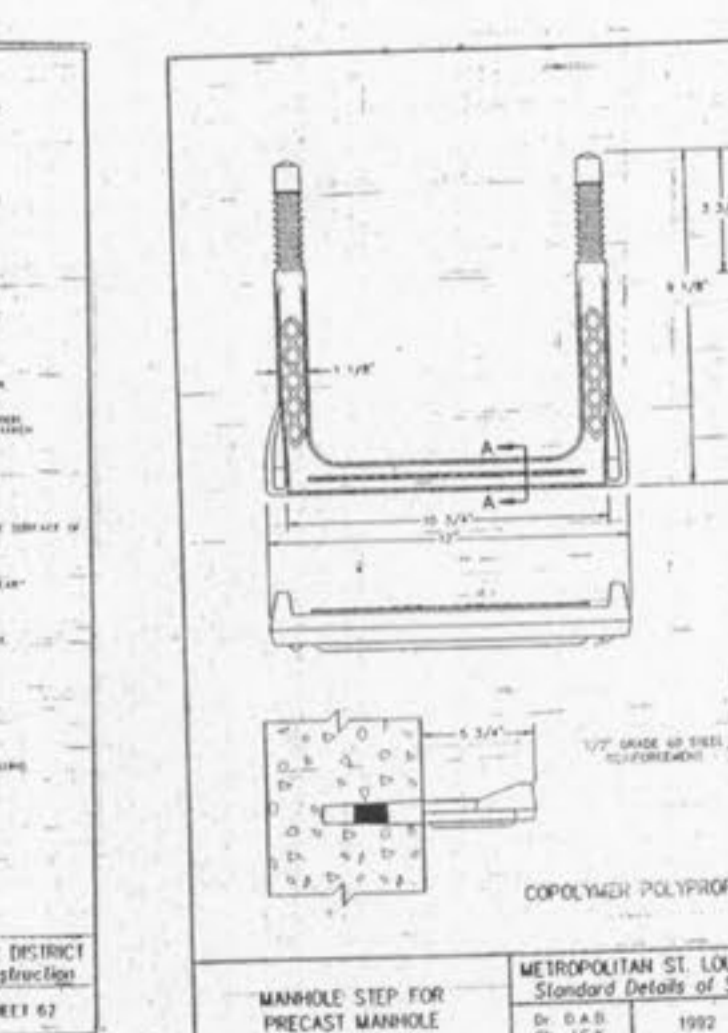
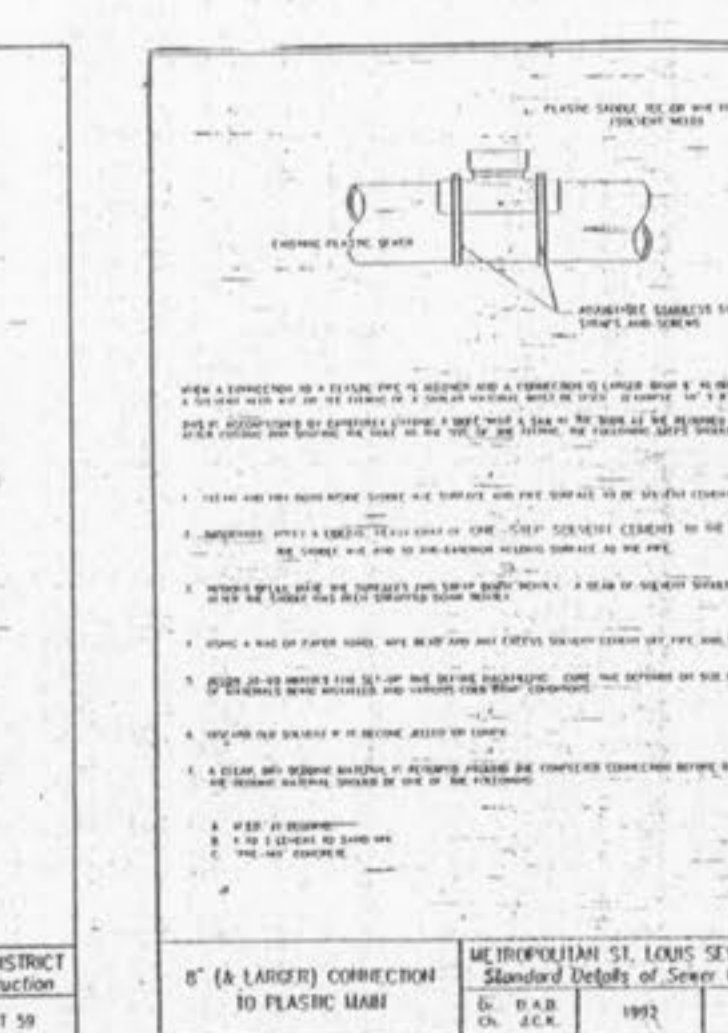
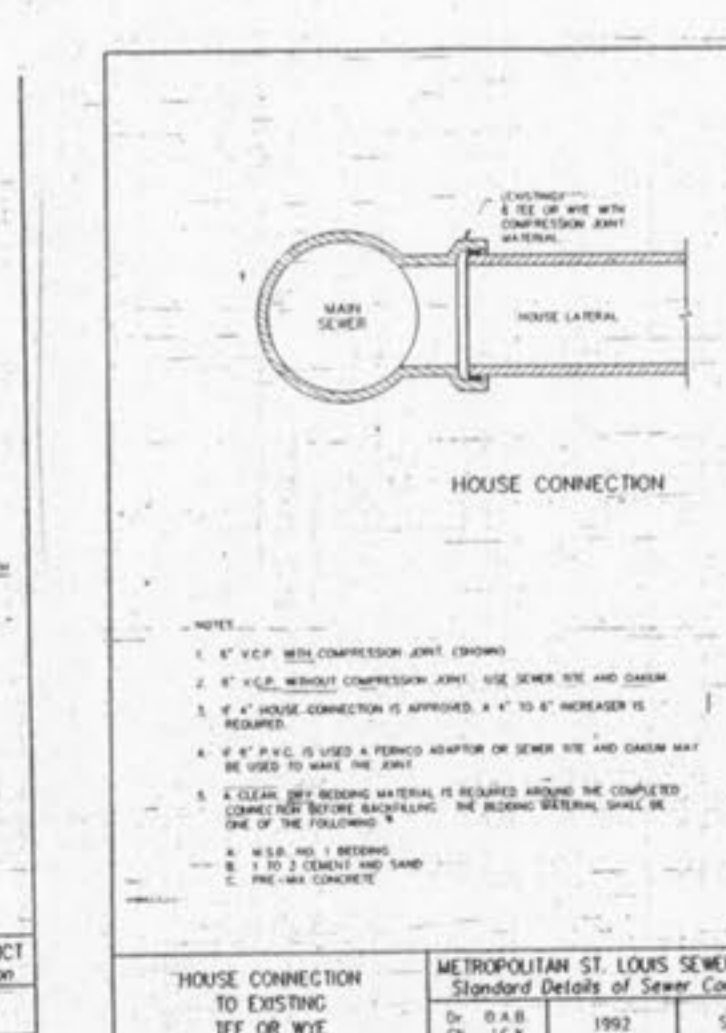
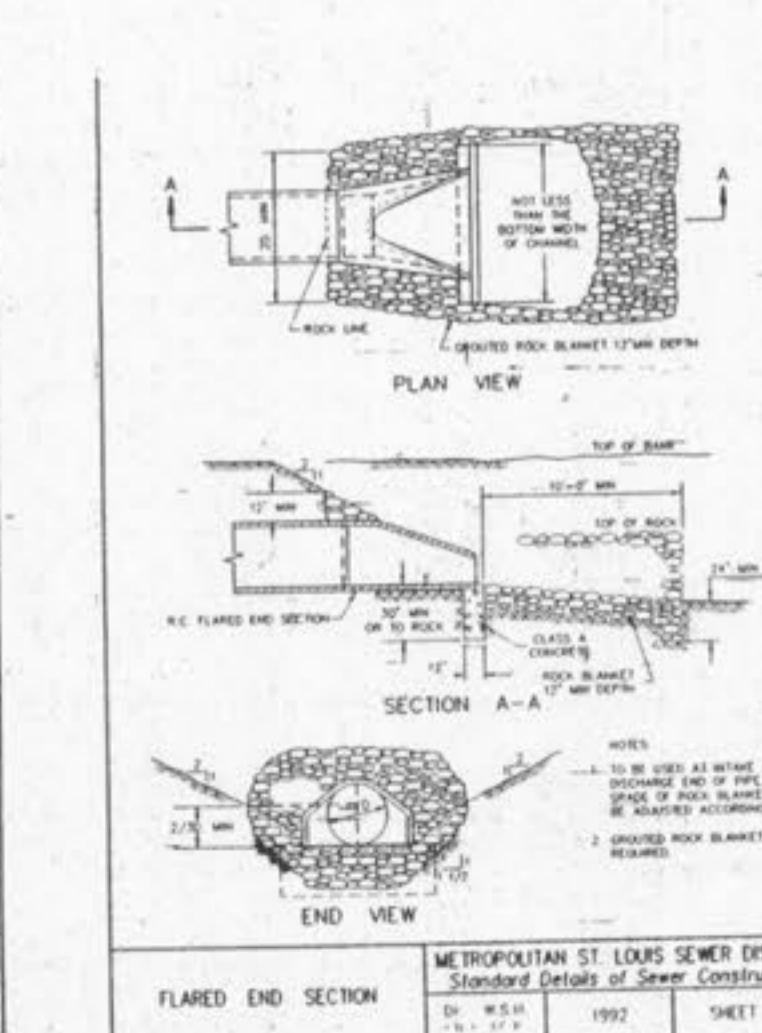
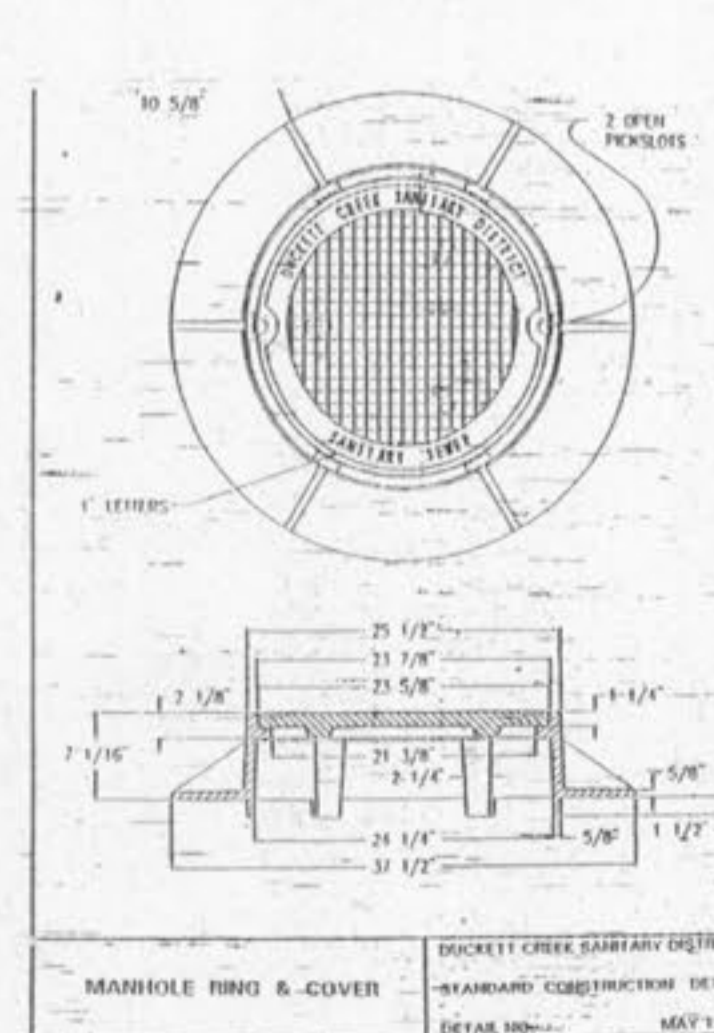
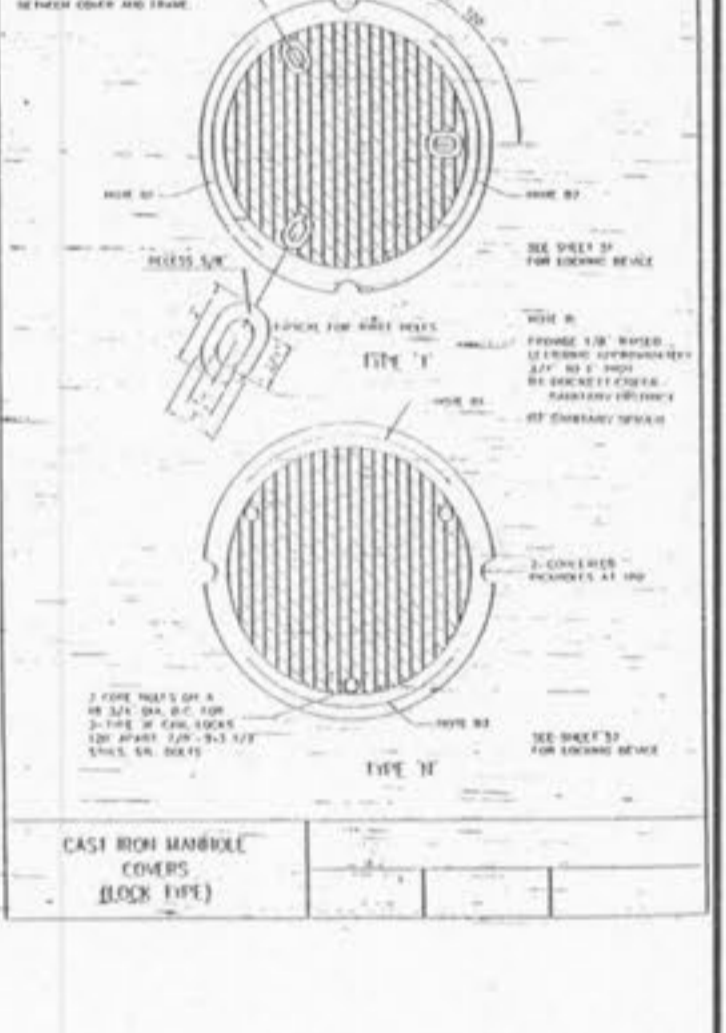
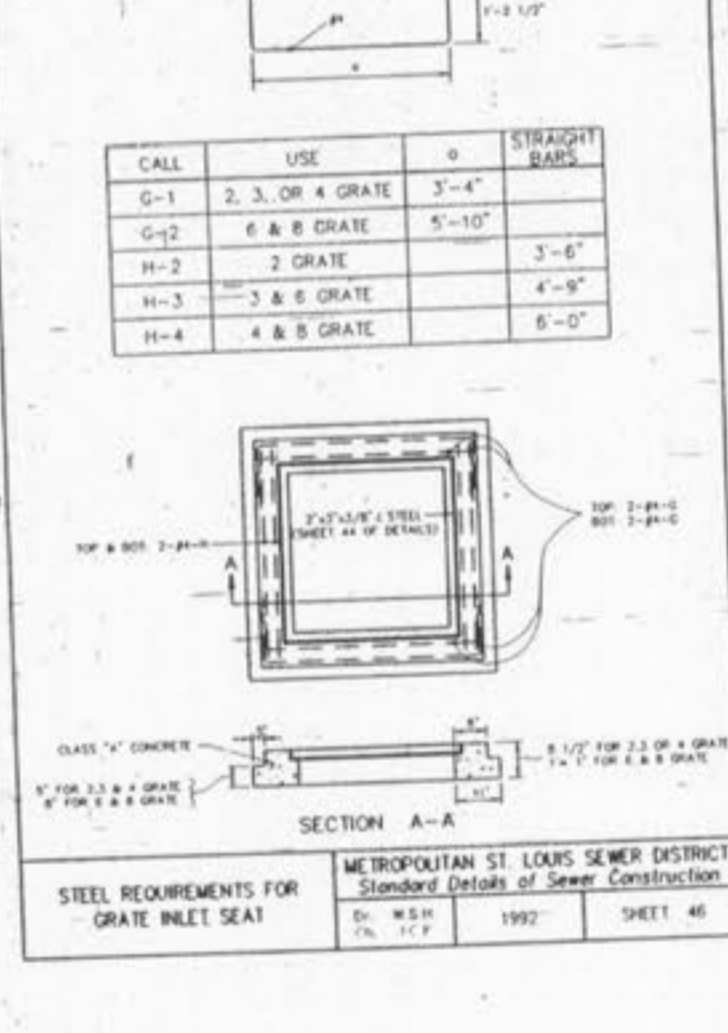
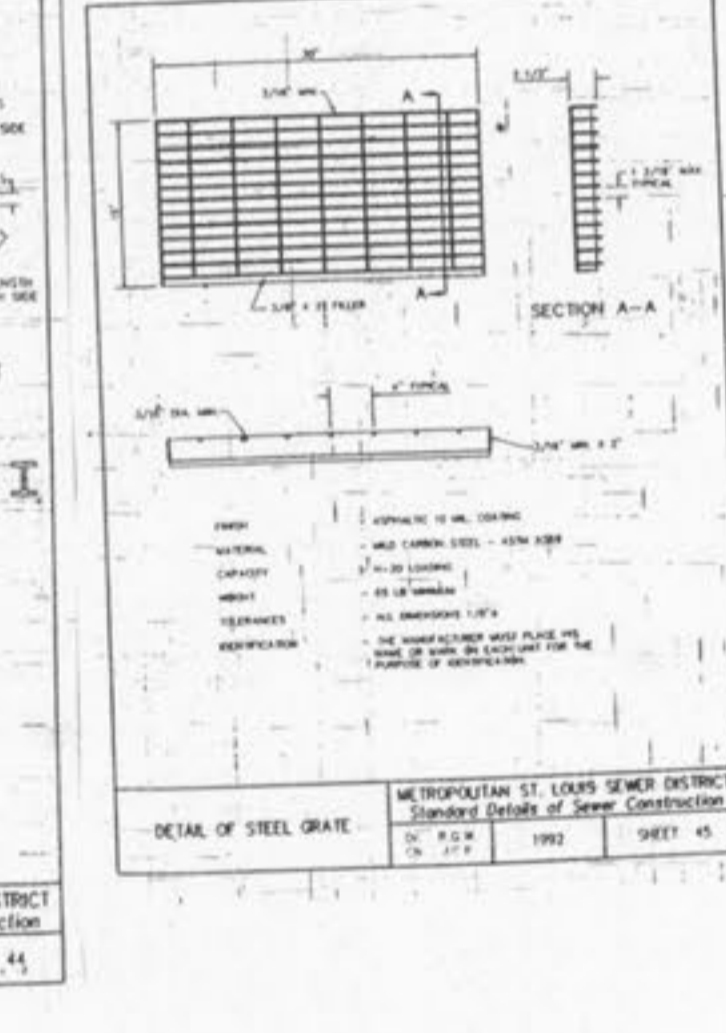
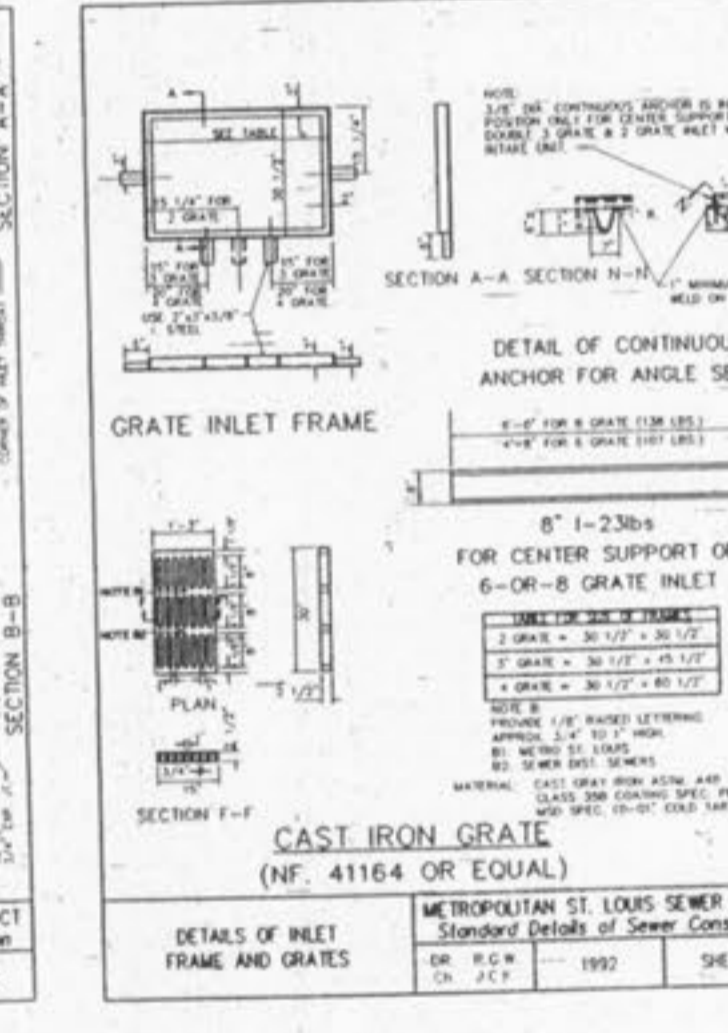
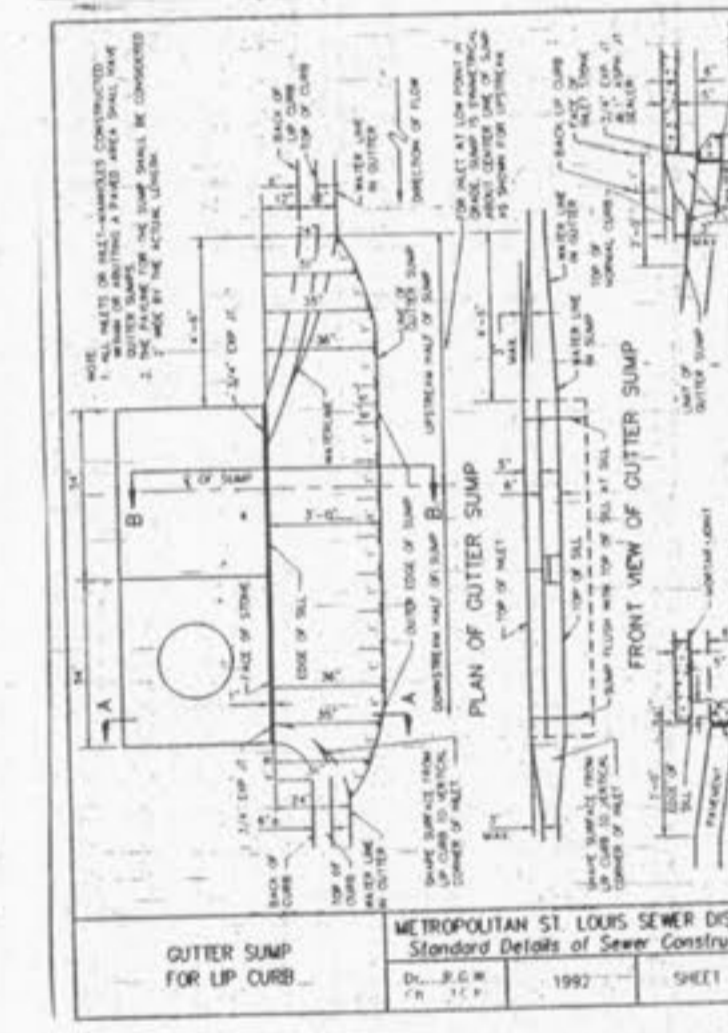
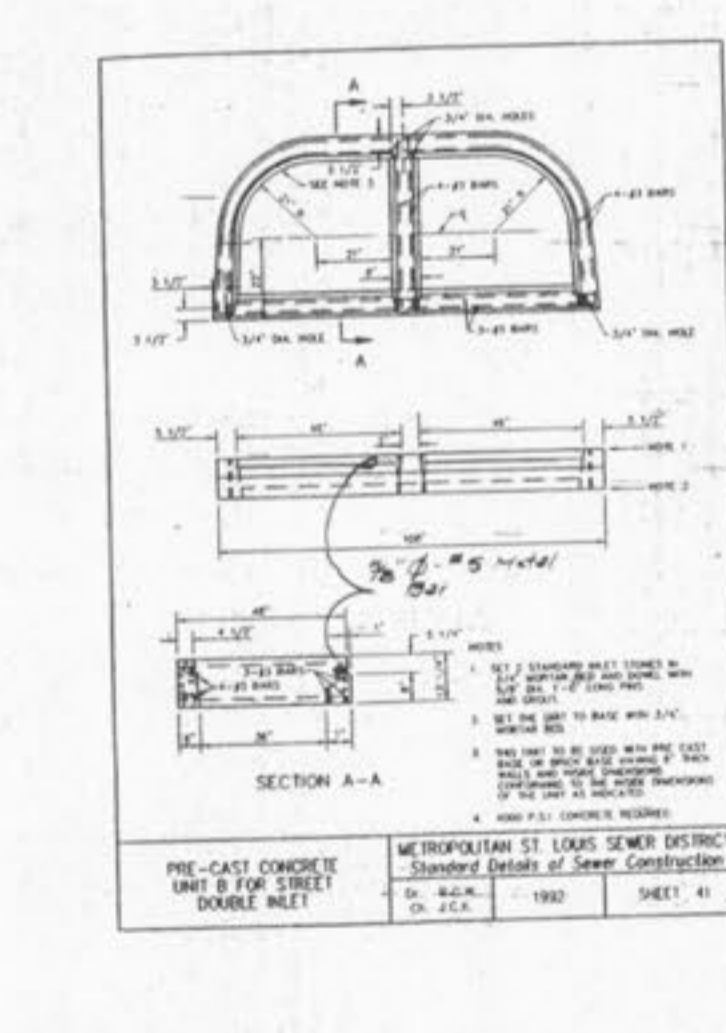
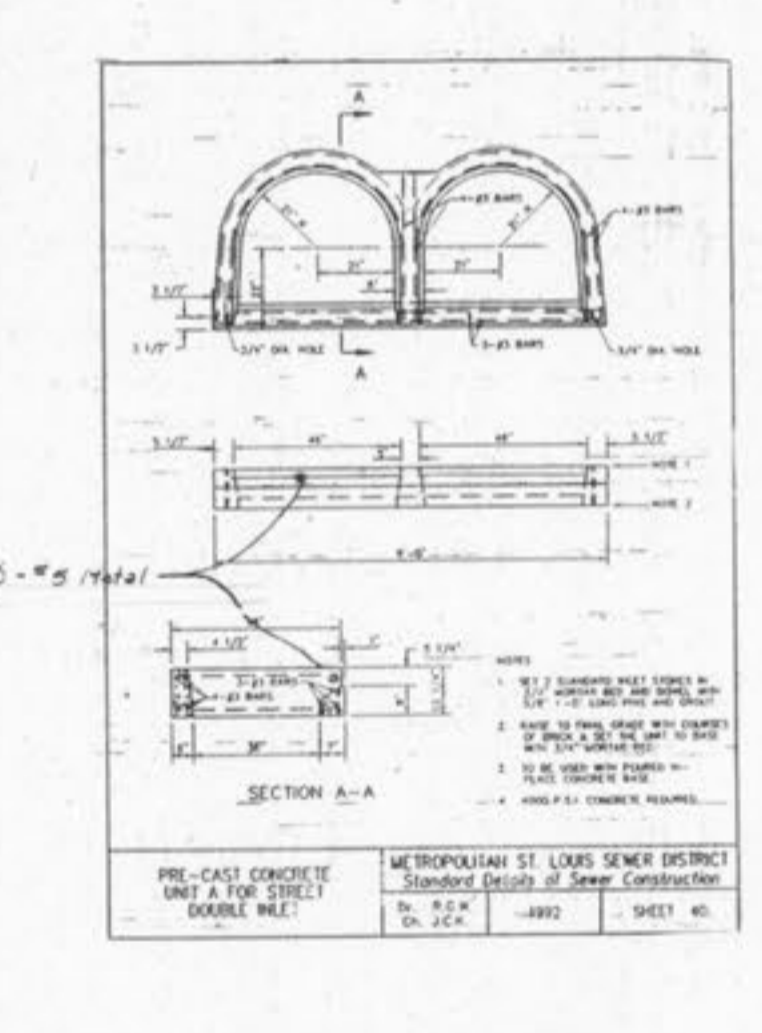
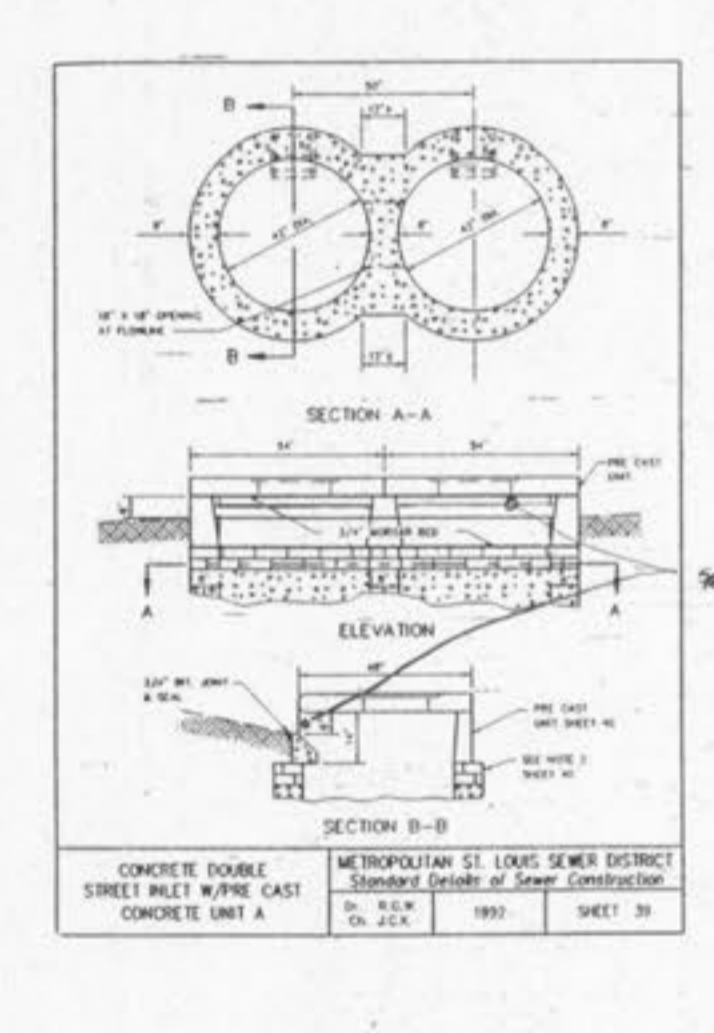
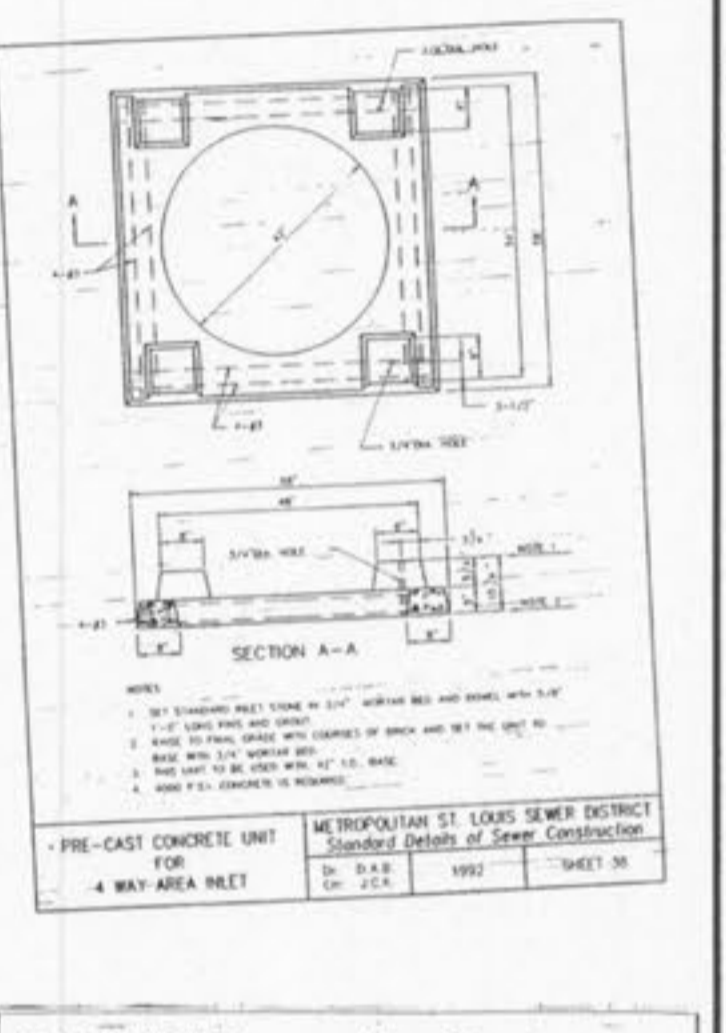
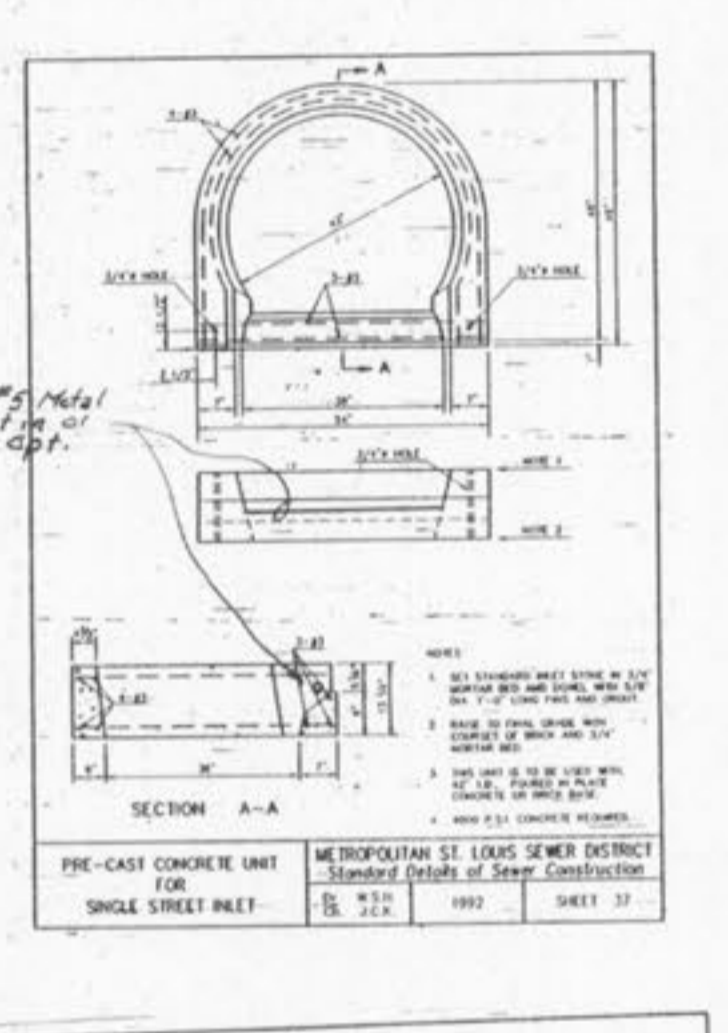
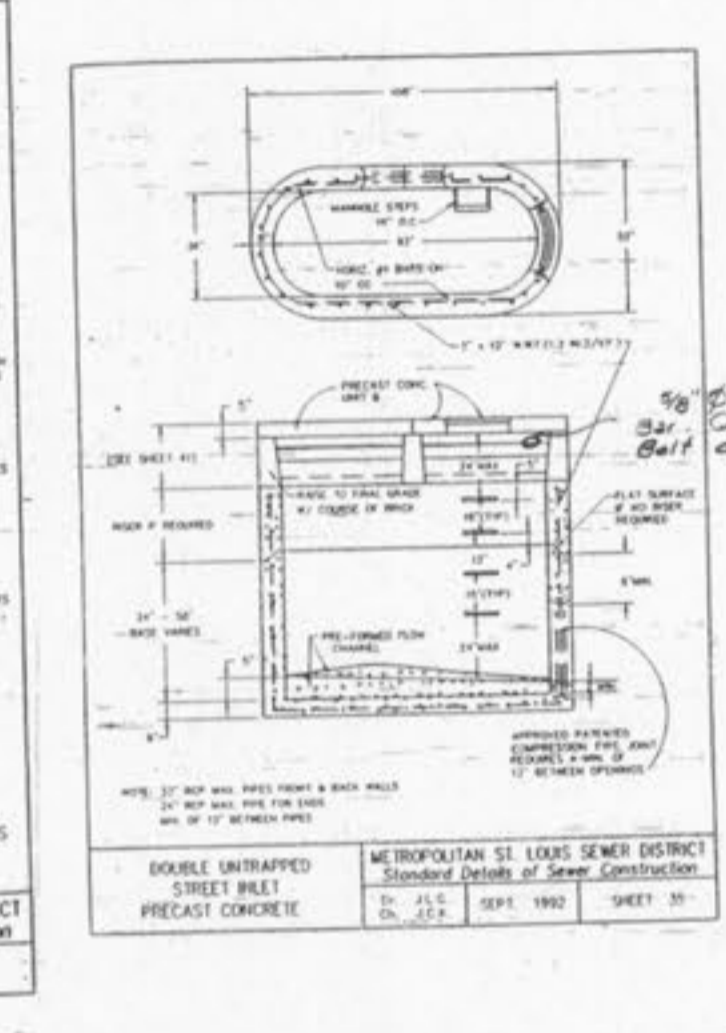
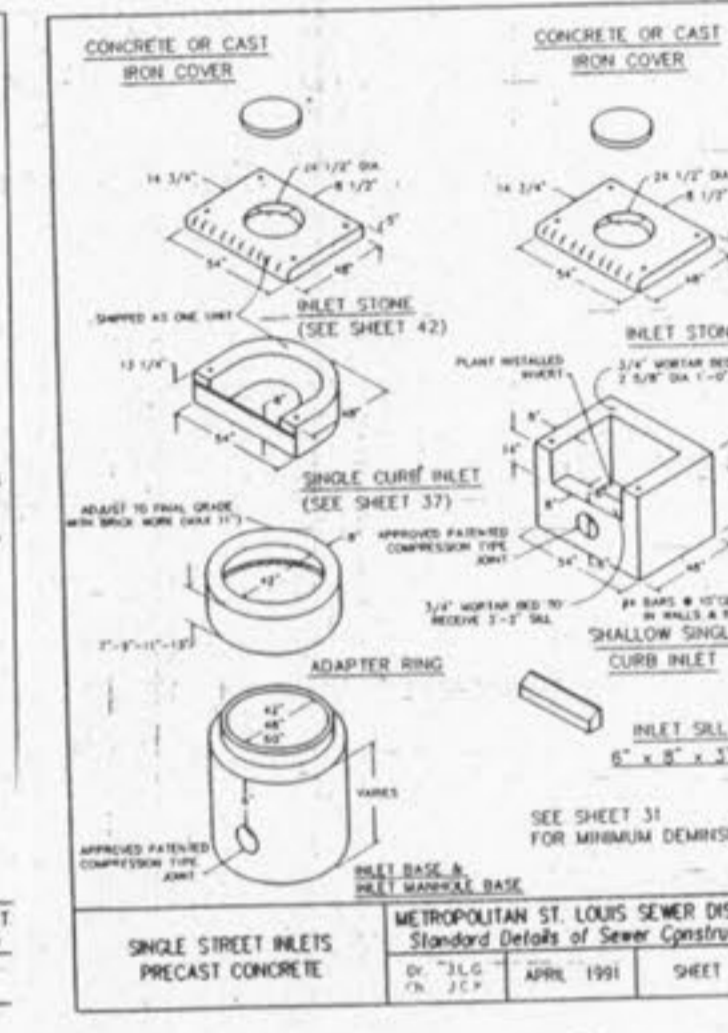
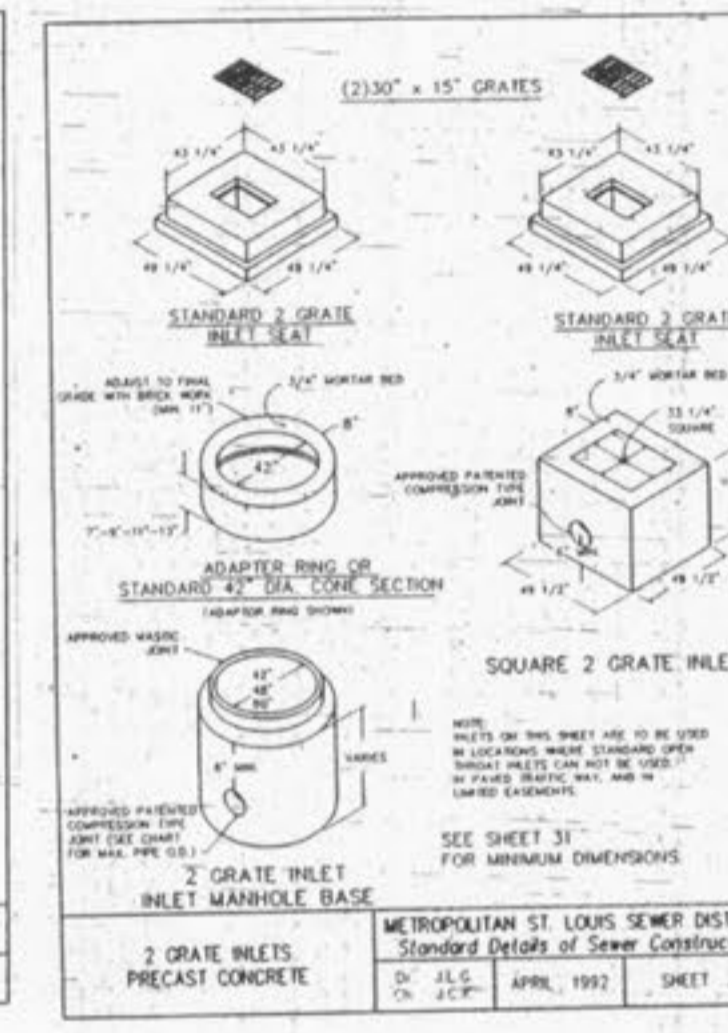
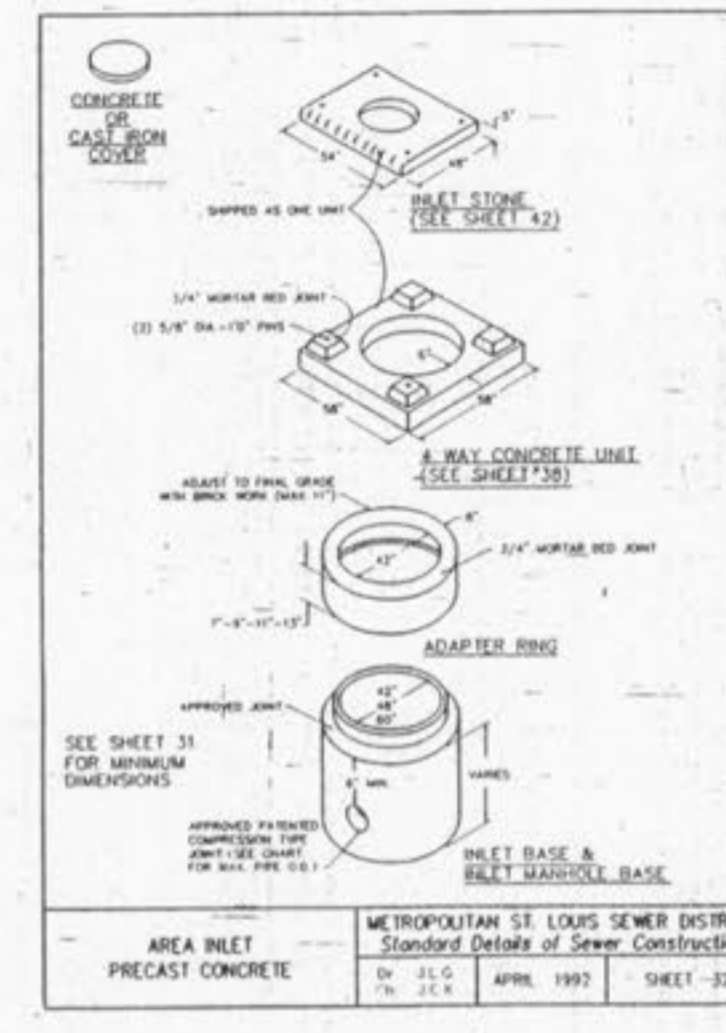
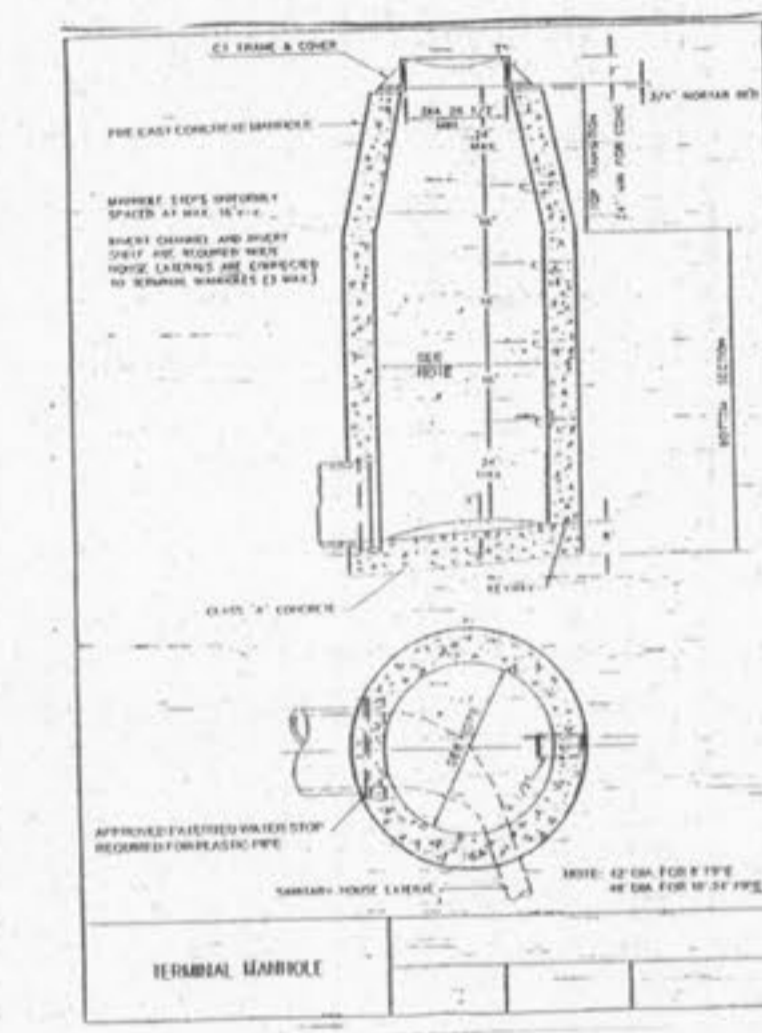
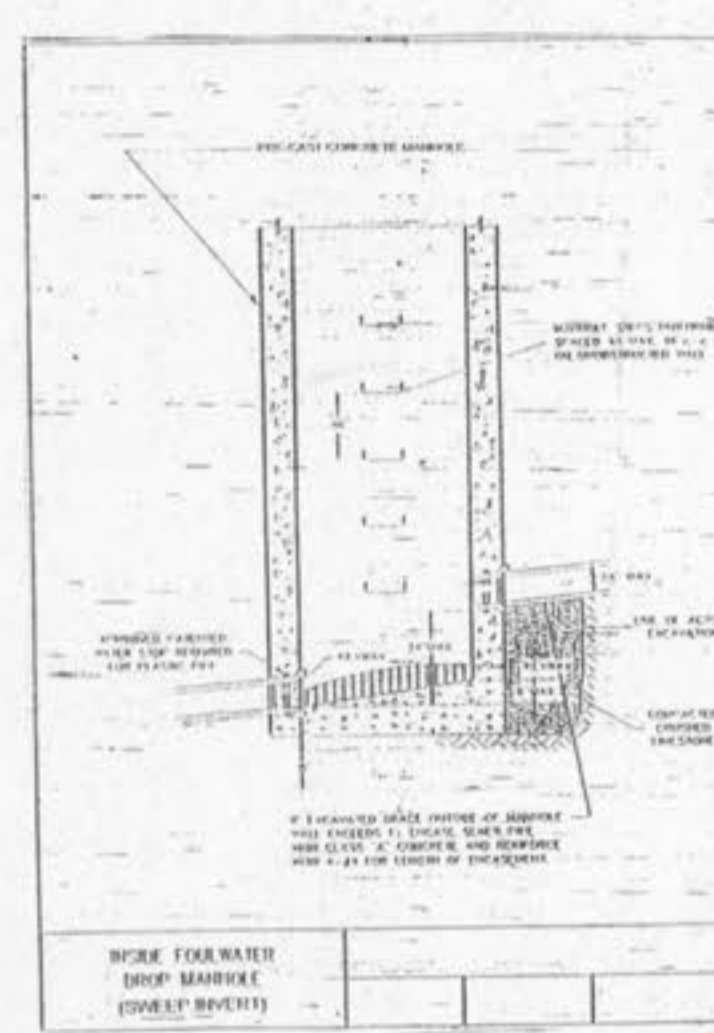
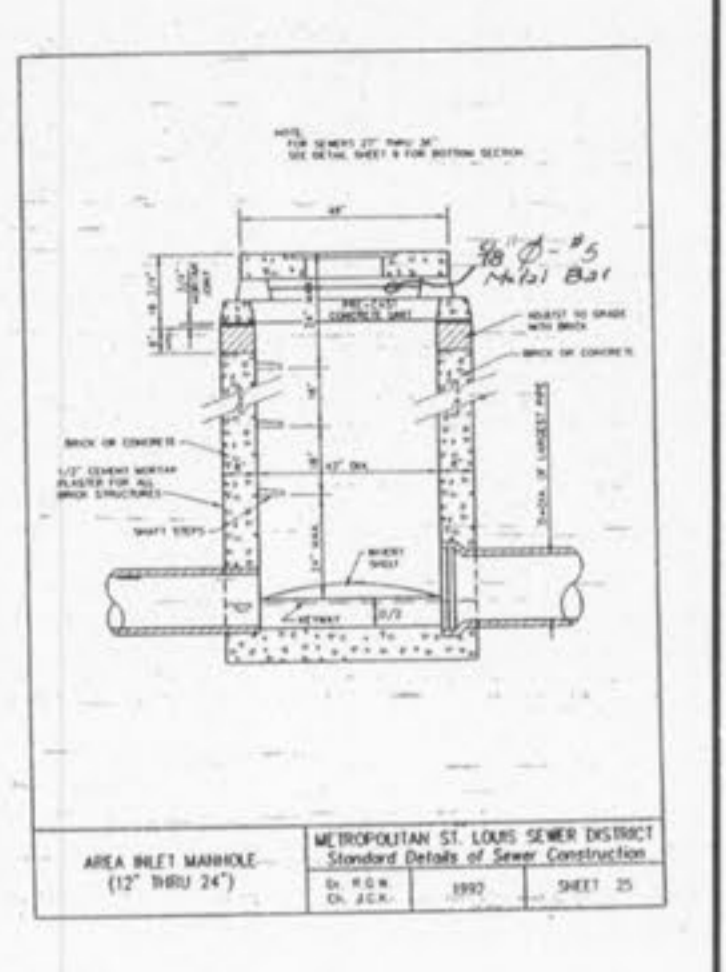
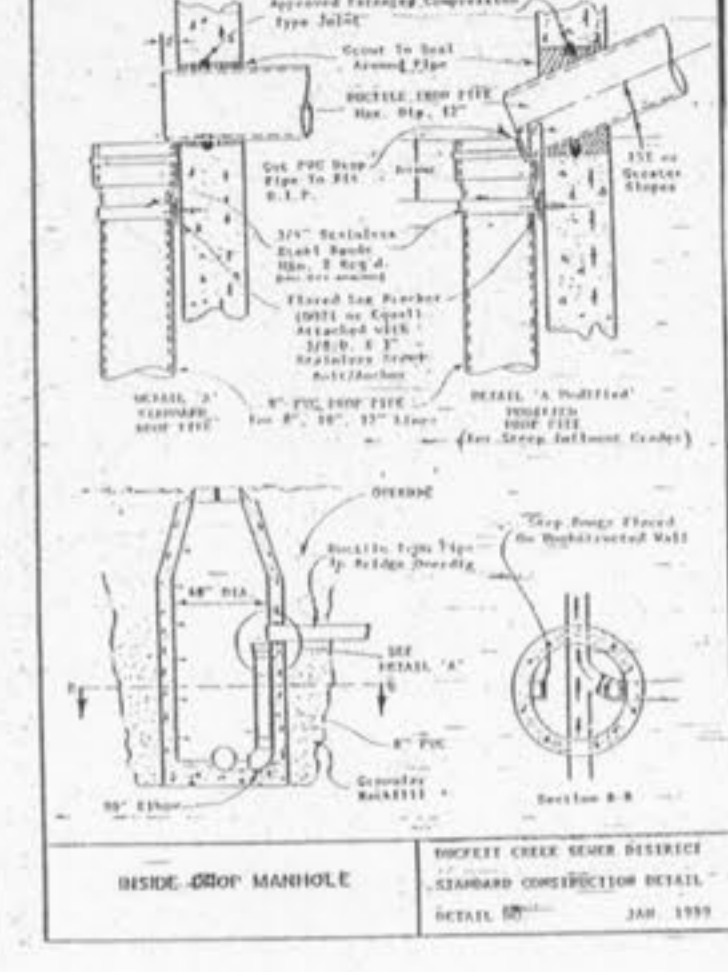
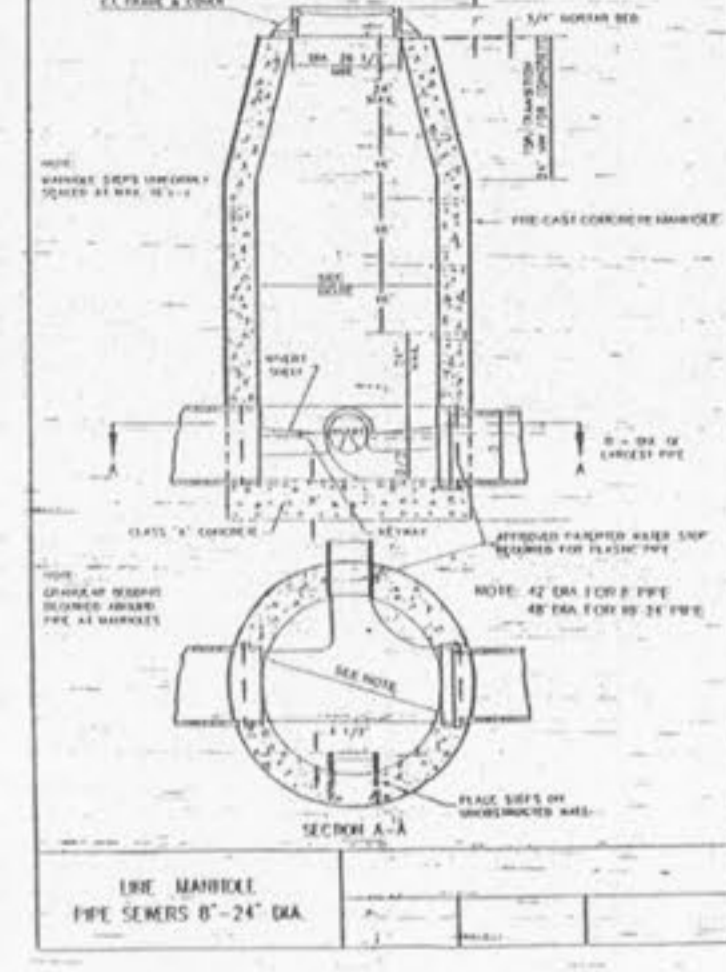
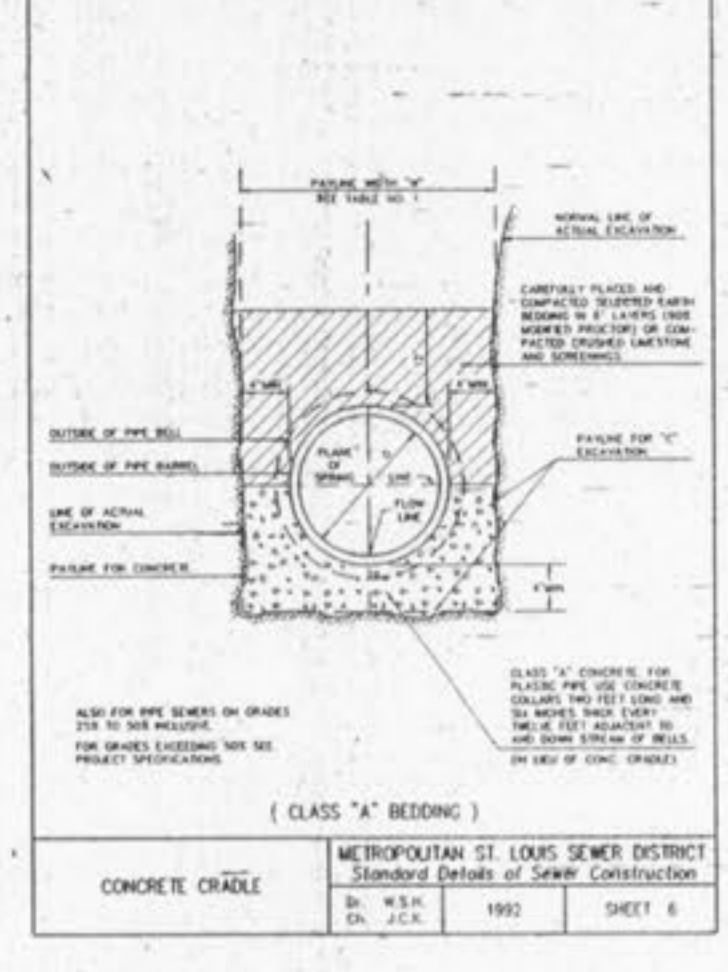
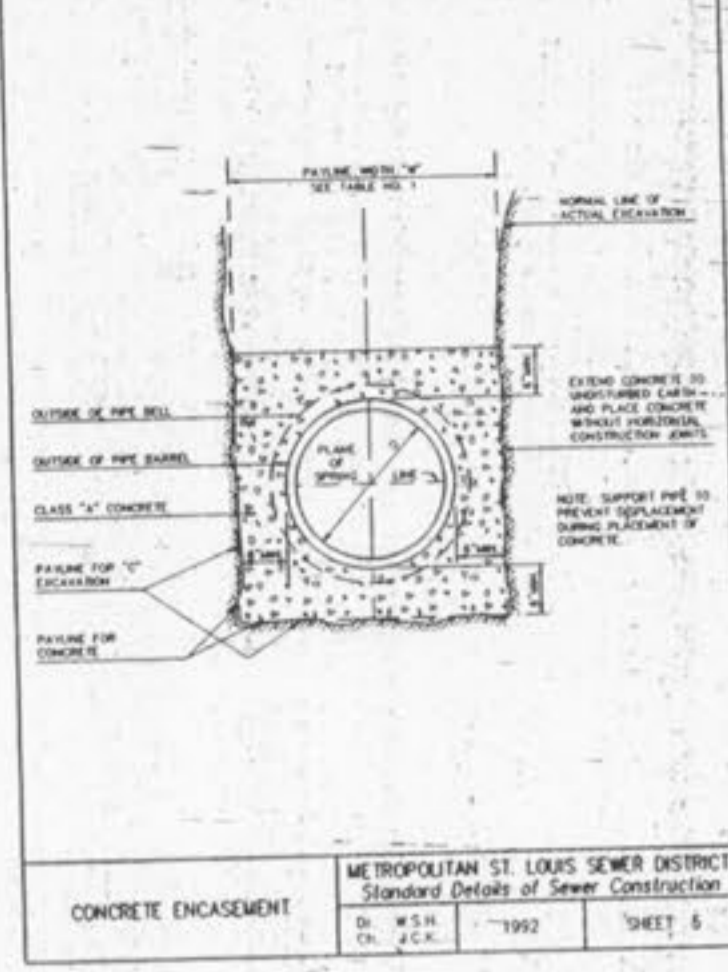
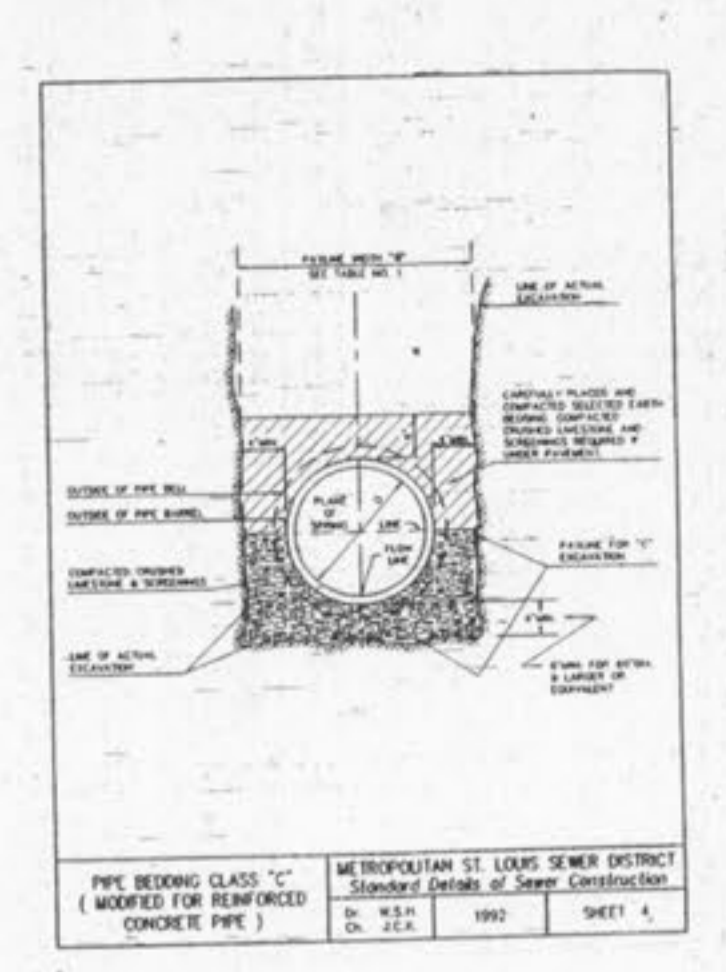
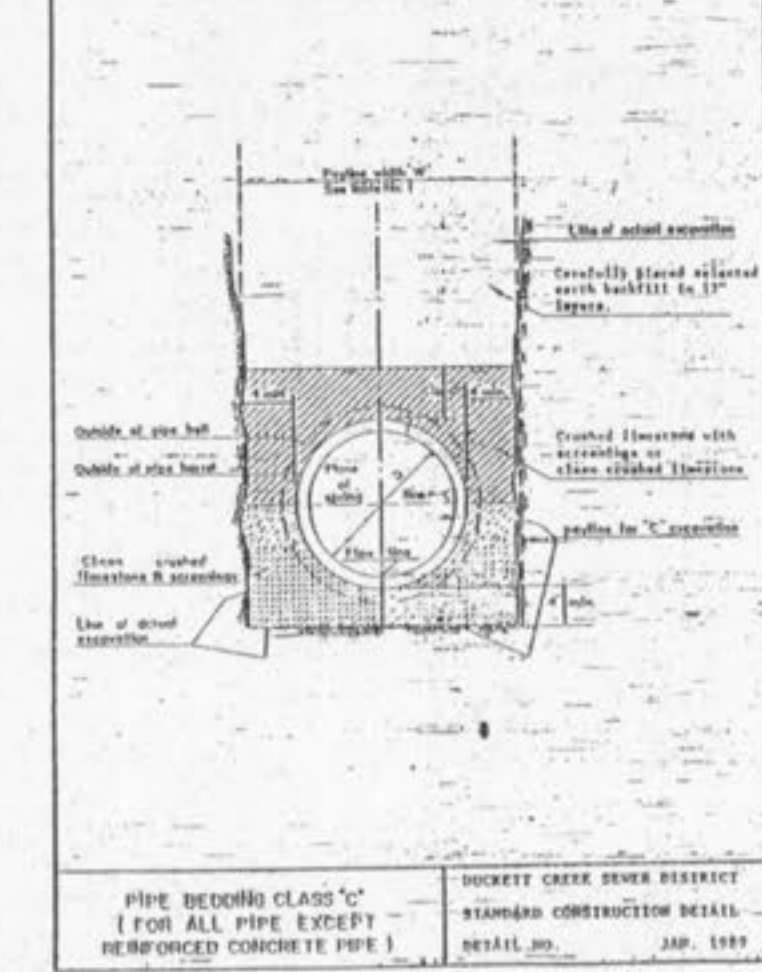

**WINGHAVEN**  
RESIDENTIAL L.L.C.  
111 W. BROADWAY  
CORPORATE CENTER DRIVE  
ST. LOUIS, MISSOURI 63102  
PHONE (314) 537-2000

**VOLZ**

ELMER ANTHONY KRUSSEL  
REGISTERED PROFESSIONAL ENGINEER  
NO. 10000  
STATE OF MISSOURI

**WINGHAVEN**

**CONSTRUCTION DETAILS**  
Design By: R.L.M.  
Drawn By: M.E.K.  
Checked By: E.A.K.

B-5500

08.02.99