



ENGINEERING
PLANNING
SURVEYING

RECEIVED
AUG 15 2002
CITY OF O'FALLON, MO

STORMWATER DETENTION ANALYSIS
PREPARED BY: BAX ENGINEERING CO., INC.

Avondale Heights & Pennial Park - CITY OF O'FALLON

Detention Analysis For Remainder of Development

BAX PROJECT NO. 96-8791 & 95-7230S

August 13, 2002

INTRODUCTION

Basins proposed in this phase of the development, analyzed in this and previous reports, are designed to operate together as system. For example the basin proposed in Avondale Heights, outlined in this report, cannot operate effectively without the basin in Pennial Park functioning at its design capacity. This analysis was completed on the basis of the basins operating as a whole not individually.

Portions of Avondale Heights and Pennial Park have been previously developed with detention for those developed portions being provided in permanent dry basins and one temporary basin. This detention analysis and report will complete the detention requirements for the overall development limits of both Avondale Heights and Pennial Park.

A majority of the remaining pre-developed area flows to the south collecting in two medium size tributaries draining the development. Both tributaries are to remain following development under the current plan. One tributary flows eastward and runs along the southern boundary of the site. It is labeled as East Branch Tributary B on the Pre and Post-Developed Drainage Area Maps and will be referred to as such through the remainder of this report. The other creek flows north to south beginning at the northern edge of the Avondale Heights limits at the outfall of the Pennial Park basin, on the Pre and Post-Developed Drainage Area Maps it is labeled as Secondary Creek and will hereto be referred to as Secondary Creek throughout the report.

At the confluence of these two drainage ways is the ultimate outfall point of the development, labeled as Discharge Point #1 on both Pre and Post-Developed Drainage Area Maps. Our analysis uses this point as the overall controlling point as a basis for the detention requirements for the site. Detention will ensure that the post-developed flow to the ultimate discharge point will be less than or equal to the existing flow at that point.

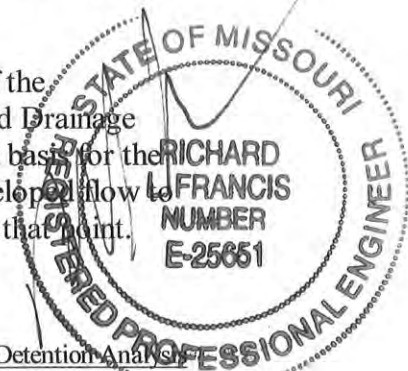

We will also be checking two additional discharge points, one at the intersection of the property boundary and the aforementioned Secondary Creek, hereon known as Discharge Point #2. Discharge Point #3 is located at the intersection of the property boundary and East Branch Tributary B. It is labeled on both the Pre and Post-Developed Drainage Area Maps. Post-Developed flows will be checked at each of the two points ascertaining that they are less than or equal to existing flows.

Detention of runoff will be provided in two wet basins, one within the Pennial Park development, and the other in Avondale Heights. Both are shown on the Post-Developed Drainage Area Map. The basin in Pennial Park is located on the southern edge of the Pennial Park limits, abutting Avondale Heights on the south. The basin discharges into the creek bisecting Avondale Heights on its eastern side, known as Secondary Creek. It is designed as a wet detention facility with a normal water surface elevation of 516.00. The Pennial basin receives a substantial amount of runoff from offsite to the north. Included in the offsite runoff are areas of Cherrywood Parc Plat Five, The Villages of Hutchings Farm, The Estates at Legacy Point and Bradford Heights. From these areas, three existing detention facilities are outfalling to the Pennial basin. More specifically Cherrywood Parc's Plat Five basin, a large basin wet in The Villages of Hutchings Farm and Basin B of The Estates at Legacy Point development. To develop an accurate model of the watershed, detained outflows from the basin were used to generate inflow hydrographs to the Pennial basin. To produce outflow hydrographs at the desired interval and length, input data taken from approved reports was used to recalculate outflow hydrographs from each of the three off-site basins. Recalculating each basin was necessary due to the previous analyzes outflow hydrographs prematurely terminating before all rainfall had left the basin. Each basin is connected to the Pennial basin via a storm sewer network. Outflow hydrographs from each offsite basin were lagged by a specific time that was ascertained by estimating the length of travel time required to traverse through the sewer network as runoff flows to the Pennial basin. By adding this lag time to the front end of each outflow hydrograph, inflow hydrographs into the Pennial basin were generated. The reports and calculations were provided by the City of O'Fallon for Cherrywood Parc and Hutchings Farm, The Estates at Legacy Point detention was designed in-house. The basins were re-ran in Pond7 using information from the reports to achieve outflows at the time interval and overall time period needed for this analysis. Analyzes of the existing basins are included in the calculations section of this report. Other offsite flow to Pennial Park does not flow thru any basin on or off-site on route to the Pennial Park basin, mainly that from The Estates at Legacy Point and Bradford Heights. A time of concentration was determined for that offsite area to achieve an accurate inflow hydrograph. All offsite flows are labeled on the Pre and Post-Developed Drainage Area Maps.

The second basin analyzed in this report is located in Avondale Heights at the southern end of the property along the west side of the creek bisecting the site. Only on-site inflow from Avondale Heights flows to this basin, making the analysis much simpler. The basin outfalls into the Secondary Creek just to the north of the property line. A wet basin design is also used for this facility with a normal water elevation of 498.00.

Directly across the creek from the southern end of the Avondale Heights basin is an existing basin constructed during Phase 4 of Avondale Heights. Grading the remainder of Avondale Heights will reduce the amount of runoff making it to this basin, therefore a reanalysis of the facility has been completed. The analysis is included in this report and revised outflows are shown on the Post-Developed Drainage Area Map.

Each of the basins will be analyzed for the 15 year and 25 year, 20 minute design storms where the 25-year storm is the controlling storm. Each will also be checked for safe passage of the 100 year, 20 minute design storm under low-flow blocked conditions. Again, the basins are designed as a single system, all of the basins must be looked at as an overall system for the following analysis to meet requirements for each development.

EXISTING AND PROPOSED P.I. FACTORS

The pre-developed P.I. factors to be used for the analysis are:

15 Year - 20 Minute storm (5% Imperious):	1.87 cfs/acre ✓
25Year - 20 Minute storm (5% Impervious):	2.31 cfs/acre ✓

The post-developed P.I. factors to be used for the analysis are:

R-1 ZONING (SINGLE FAMILY RESIDENTIAL)

15 Year - 20 Minute storm (50% Impervious):	2.64 cfs/acre ✓
25 Year - 20 Minute storm (50% Impervious):	3.26 cfs/acre ✓
100 year - 20 Minute storm (50% Impervious):	4.17 cfs/acre ✓

EXISTING RUNOFF TO DISCHARGE POINTS

ULTIMATE OUTFALL POINT – DISCHARGE POINT #1

Existing runoff to the ultimate outfall point has been determined from the attached Pre-Developed Drainage Area Map. (see attached) Offsite flows are included.

15 Year, 20 Minute storm:	539.05 cfs
25 Year, 20 Minute storm:	680.13 cfs ✓

DISCHARGE POINT #2

Existing runoff has been determined from the Pre-Developed Drainage Area Map. (see attached) Offsite flows are included.

15 Year, 20 Minute storm: **406.78 cfs**

25 Year, 20 Minute storm: **516.72 cfs**

DISCHARGE POINT #3

Existing runoff has been determined from the Pre-Developed Drainage Area Map. (see attached)

15 Year, 20 Minute storm: **132.28 cfs**

25 Year, 20 Minute storm: **163.41 cfs**

TIME OF CONCENTRATION

AREAS DRAINING TO PENNIAL PARK BASIN

On-Site Area (Pennial Park Area)

The time of concentration flow path begins in the middle of the rear yard of Lot 184 of Pennial Park. Runoff flows overland for approximately 185 feet to the east along the rear yards of Lots 183 and 182; continuing in the swale as shallow concentrated flow along the rear of Lots 181, 180 and 179 for approximately 215 feet before entering the storm sewer system at area inlet 165A. From there the flowpath traverses thru 1,880 feet of storm sewer before entering the Pennial Park Basin at FE 101. Time of concentration is estimated as follows:

$T_{(overland)}$: L = 185 feet
 Elevation difference = 6.5 feet
 $T_{(overland)} = 3.0$ minutes: see figure 1A

$T_{(swale)}$: L = 215 feet
 Elevation difference = 5.0 feet
 $T_{(swale)} = 2.0$ minutes: see figure 1A

$T_{(pipe)}$: L = 1,880 feet
 Estimated Average Velocity of 9.0 ft./sec.
 $T_{(pipe)} = 209$ seconds

$T_{(pipe\ total)} = 209\ sec. \approx 3.50\ Min.$

$T_{(overland\ total)} = 5.0\ Min$

$T_{(Total)} = 8.50\ Min$ **Use 9.0 Min.**

Off-Site Areas 1 & 2 (To Pennial Park Basin)

Off-site areas 1 and 2 include flows from The Villages at Hutchings Farm and Cherrywood Parc, including outflow from the detention basin of Plat Five of Cherrywood Parc. The time of concentration for these two areas is calculated by estimating the travel time through the storm sewer system flowing to the Pennial basin, starting from manhole 85. The time of concentration is also considered as the lag time for the outflow hydrograph from the Cherrywood Parc basin and is estimated as follows:

$$\begin{aligned} T_{(\text{pipe})}: & \quad L = 1,322 \text{ feet} \\ & \quad \text{Estimated Average Velocity of } 9.0 \text{ ft./sec.} \\ & \quad T_{(\text{pipe})} = 147 \text{ seconds} \\ & \quad T_{(\text{pipe total})} = 147 \text{ sec. } \approx 2.50 \text{ Min.} \\ & \quad T_{(\text{Total})} = 2.50 \text{ Min } \text{ Use } \mathbf{3.0 \text{ Min.}} \end{aligned}$$

Off-Site Areas 3-The Villages at Hutchings Farm

Off-site area 3 includes the outflow from the retention lake currently operating in The Villages at Hutchings Farm. The lag time or time of concentration for this area is determined by estimating the pipe travel time to the Pennial Basin. Travel time calculations begin at area inlet 67, flowing approximately 1,611 feet on its course to the Pennial Basin. Time of concentration is estimated as follows:

$$\begin{aligned} T_{(\text{pipe})}: & \quad L = 1,322 \text{ feet} \\ & \quad \text{Estimated Average Velocity of } 9.0 \text{ ft./sec.} \\ & \quad T_{(\text{pipe})} = 147 \text{ seconds} \\ & \quad T_{(\text{pipe total})} = 147 \text{ sec. } \approx 2.50 \text{ Min.} \\ & \quad T_{(\text{Total})} = 2.50 \text{ Min } \text{ Use } \mathbf{3.0 \text{ Min.}} \end{aligned}$$

Off-Site Area 4 (Bradford Heights and Estates at Legacy Point)

The time of concentration flow path at the building line of Lot 32 of Bradford Heights. Runoff flows overland for approximately 283 feet to the south along the rear yards of Lots 33 and 34 of Bradford Heights and Lot 255 of Villages at Hutchings Farm before entering the storm sewer system at an area inlet in Hutchings Farm on the lot line of Lots 254 & 255. Flow continues 2,806 feet thru the storm sewer system before entering the Pennial Basin. Time of concentration is estimated as follows:

$$\begin{aligned} T_{(\text{overland})}: & \quad L = 283 \text{ feet} \\ & \quad \text{Elevation difference} = 17.5 \text{ feet} \\ & \quad T_{(\text{overland})} = 3.5 \text{ minutes: see figure 1B} \\ \\ T_{(\text{pipe})}: & \quad L = 2,806 \text{ feet} \\ & \quad \text{Estimated Average Velocity of } 9.0 \text{ ft./sec.} \\ & \quad T_{(\text{pipe})} = 312 \text{ seconds} \\ & \quad T_{(\text{pipe total})} = 312 \text{ sec. } \approx 5.20 \text{ Min.} \\ & \quad T_{(\text{overland total})} = 3.5 \text{ Min} \\ & \quad T_{(\text{Total})} = 8.70 \text{ Min } \text{ Use } \mathbf{9.0 \text{ Min.}} \end{aligned}$$

Off-Site Area 5 (Estates at Legacy Point)

The time of concentration flow path begins in Lot 88 at the building line. Runoff flows overland for approximately 231 feet to the south and west along the rear yards of Lot 91, continuing 74 feet as shallow concentrated flow before entering the storm sewer system at area inlet 152. Flow then travels 3,890 feet thru the storm sewer system before entering the Pennial Basin. Time of concentration is estimated as follows:

$$\begin{aligned} T_{(\text{overland})}: & \quad L = 231 \text{ feet} \\ & \quad \text{Elevation difference} = 16.0 \text{ feet} \\ & \quad T_{(\text{overland})} = 3.2 \text{ minutes: see figure 1C} \end{aligned}$$

$$\begin{aligned} T_{(\text{swale})}: & \quad L = 74 \text{ feet} \\ & \quad \text{Elevation difference} = 7.0 \text{ feet} \\ & \quad T_{(\text{swale})} = 0.4 \text{ minutes: see figure 1C} \end{aligned}$$

$$\begin{aligned} T_{(\text{pipe})}: & \quad L = 3,890 \text{ feet} \\ & \quad \text{Estimated Average Velocity of } 9.0 \text{ ft./sec.} \\ & \quad T_{(\text{pipe})} = 432 \text{ seconds} \end{aligned}$$

$$\begin{aligned} T_{(\text{pipe total})} &= 432 \text{ sec. } \approx 7.20 \text{ Min.} \\ T_{(\text{overland total})} &= 3.60 \text{ Min} \\ T_{(\text{Total})} &= 10.80 \text{ Min } \textbf{Use 10.0 Min.} \end{aligned}$$

Off-Site Areas 6-The Estates at Legacy Point; Basin B

Off-site area 6 includes the outflow from the retention lake currently operating in the subdivision. The lag time or time of concentration for this area is determined by estimating the pipe travel time to the Pennial Basin. Travel time calculations begin at outfall structure 141, flowing approximately 3,357 feet on way to the Pennial Basin. Time of concentration or lag time is estimated as follows:

$$\begin{aligned} T_{(\text{pipe})}: & \quad L = 3,357 \text{ feet} \\ & \quad \text{Estimated Average Velocity of } 9.0 \text{ ft./sec.} \\ & \quad T_{(\text{pipe})} = 380 \text{ seconds} \end{aligned}$$

$$\begin{aligned} T_{(\text{pipe total})} &= 380 \text{ sec. } \approx 6.21 \text{ Min.} \\ T_{(\text{Total})} &= 6.21 \text{ Min } \textbf{Use 6.0 Min.} \end{aligned}$$

AREA TO AVONDALE PHASE 7 BASIN

On-Site Area to proposed basin

The time of concentration flow path begins in the middle of Lot 591 of Avondale Heights towards the rear of the lot. Runoff flows overland for approximately 152 feet to the east along the side and rear of Lots 591 & 590 into the rear yard swale, continuing in the swale as shallow concentrated flow along Lot 589 for approximately 110 feet before entering the storm sewer system at an area inlet at the corner of Lots 589 and 588. Flow traverses thru approximately 719 feet of storm sewer system before entering the Avondale Basin. Time of concentration is estimated as follows:

$$T_{(\text{overland})}: \quad \begin{array}{l} L = 152 \text{ feet} \\ \text{Elevation difference} = 8.0 \text{ feet} \\ T_{(\text{overland})} = 2.4 \text{ minutes: see figure 1D} \end{array}$$

$$T_{(\text{swale})}: \quad \begin{array}{l} L = 110 \text{ feet} \\ \text{Elevation difference} = 4.0 \text{ feet} \\ T_{(\text{swale})} = 1.0 \text{ minutes: see figure 1D} \end{array}$$

$$T_{(\text{pipe})}: \quad \begin{array}{l} L = 719 \text{ feet} \\ \text{Estimated Average Velocity of } 9.0 \text{ ft./sec.} \\ T_{(\text{pipe})} = 120 \text{ seconds} \end{array}$$

$$T_{(\text{pipe total})} = 120 \text{ sec. } \approx 2.00 \text{ Min.}$$

$$T_{(\text{overland total})} = 5.4 \text{ Min}$$

$$T_{(\text{Total})} = 5.4 \text{ Min Use } \mathbf{5.0 \text{ Min.}}$$

AREA TO AVONDALE PHASE 4 BASIN

On-Site Area to proposed basin

The time of concentration flow path from the previous analysis for Phase 4's basin was reused in this analysis.

OUTFALL STRUCTURE DESIGNS

Pennial Park Basin

A typical pre-cast triple area inlet with a grate top was selected as the outfall structure for this basin. A slot in the front side of the basin shall be installed at the normal water elevation of 516.00. The slot is 10 feet wide and extends to the top of the structure at 518.60. The flowline of the structure is 514.30, drained by a 3'x6'; 73 foot long box culvert. See Figure 2 for a detail of the structure. In addition to the outfall structure, an emergency spillway will be utilized at the Pennial Park basin. An emergency spillway is proposed because of the large amount of offsite flow coming to the basin. The spillway shall be 30 feet wide and 2 feet deep at an elevation of 522.00. Rip-rap shall line the entire length of the spillway from the normal water surface elevation to the outfall in the secondary creek. The emergency spillway is shown on the Post-Developed Drainage Area Map.

Avondale Heights Basin

A pre-cast single area inlet structure is utilized for the outfall structure for this basin. A grate top is scheduled. An 8"W slot at the normal water elevation of 498.00 shall be cut into the structure on the front side, extending to the top of the structure. The top elevation of the structure shall be 499.20. Flowline of the structure is designed to be 497.00 drained by a 24", 46 foot long concrete pipe. See Figure 3 for a detail of the structure.

PEAK INFLOWS TO BASINS

Inflows to the basin have been determined from the Post Developed Drainage Area Maps (see attached):

PENNIAL PARK BASIN

15 Year, 20 Minute storm:	365.75 cfs
25 Year, 20 Minute storm:	465.96 cfs
100 Year, 20 Minute storm:	618.51 cfs

Note: Inflows from offsite basins are generated from outflow hydrographs of basins. Outflow hydrograph calculations are included in calculations section.

AVONDALE HEIGHTS BASIN

15 Year, 20 Minute storm:	39.92 cfs
25 Year, 20 Minute storm:	49.29 cfs
100 Year, 20 Minute storm:	63.05 cfs

AVONDALE HEIGHTS PHASE 4 BASIN

15 Year, 20 Minute storm:	24.10 cfs
25 Year, 20 Minute storm:	29.76 cfs
100 Year, 20 Minute storm:	38.07 cfs

Note: Flows to Basin in phase 4 revised due to change in drainage areas from grading of remaining development.

STORM ROUTING CALCULATIONS AND RESULTS

As found in the routing calculations attached, the results are as follows:

Pennial Park Basin

20 Minute Storm	Calculated Release Rate	Peak Elevation
15 Year	171.13 cfs	519.58
25 Year	186.28 cfs	520.12
100 Year	227.53 cfs	521.77

Avondale Heights Basin

20 Minute Storm	Calculated Release Rate	Peak Elevation
15 Year	2.59 cfs	499.18
25 Year	6.86 cfs	499.43
100 Year	15.71cfs	499.74
100 Year OS Blocked	17.26 cfs	499.77

FLOW REQUIREMENTS

Discharge Points 1-3

At each of the three discharge points the post-developed flow must be less than the pre-developed flow. The flows, pre and post developed, are labeled at each of the three discharge points on the Post-Developed Drainage Area Map. The post-developed flow at Discharge Point #2 is calculated by summing the outflows from the Pennial Park Basin, Avondale Heights basin and Avondale Heights Phase 4 basin as well as developed and undeveloped direct runoff to Discharge Point #2. The post developed flow at Discharge Point #3 is calculated by adding the outflow from the basin in Avondale Plat 7, which was analyzed previously by Bax Engineering in a report for Avondale Plat 7 and Pennial Park Plat 2, developed and undeveloped flow to Discharge Point #3. Post Developed discharge to Discharge Point #1(ultimate discharge point) is calculated by adding the discharges from Discharge Points #1 and #2. Post-developed flows to each of the three discharge points is less than the pre-developed flows as calculated from the pre and post-developed drainage area maps. (see attached)

SUMMARY

PENNIAL BASIN

15 Year, 20 Minute H.W.	519.58
15 Year, 20 Minute Q	171.13 cfs
25 Year, 20 Minute H.W.	520.12
25 Year, 20 Minute Q	186.28 cfs
100 Year, 20 Minute H.W.	521.77
100 Year, 20 Minute Q	227.53 cfs

Standard Triple Area Inlet w/ Grate Top
Low-Flow Configuration
Normal Water Elevation
Emergency Spillway Elevation (30'W)
Top of Berm

Sill Elevation = 518.60
10'W x 2.6'H Slot @ 516.00 Elev.
516.00
522.00
524.00

AVONDALE BASIN

15 Year, 20 Minute H.W.	499.18
15 Year, 20 Minute Q	2.59 cfs
25 Year, 20 Minute H.W.	499.43
25 Year, 20 Minute Q	6.86 cfs
100 Year, 20 Minute H.W.	499.74
100 Year, 20 Minute Q	15.71 cfs
100 Year, 20 Minute H.W.-Low-Flow Blocked	499.77

Standard Precast Area Inlet w/o top
Low-Flow Configuration
Low-Flow Elevation
Top of Berm

Sill Elevation = 499.20
8"W x 1.2'H Slot @ 498.00 Elev.
498.00
502.00

PRE AND POST DEVELOPED FLOW CHECKS

Discharge Point #1

Post-Developed Q = 462.41 cfs < 680.13 cfs = Pre-Developed Q ✓

Discharge Point #2

Post-Developed Q = 302.66 cfs < 516.72 cfs = Pre-Developed Q ✓

Discharge Point #3

Post-Developed Q = 159.75 cfs < 163.41 cfs = Pre-Developed Q ✓

Time of Concentration Nomographs

**Avondale Heights
Pennial Park
Offsite Areas**



ON-SITE AREA TO PENNIAL PARK BASIN

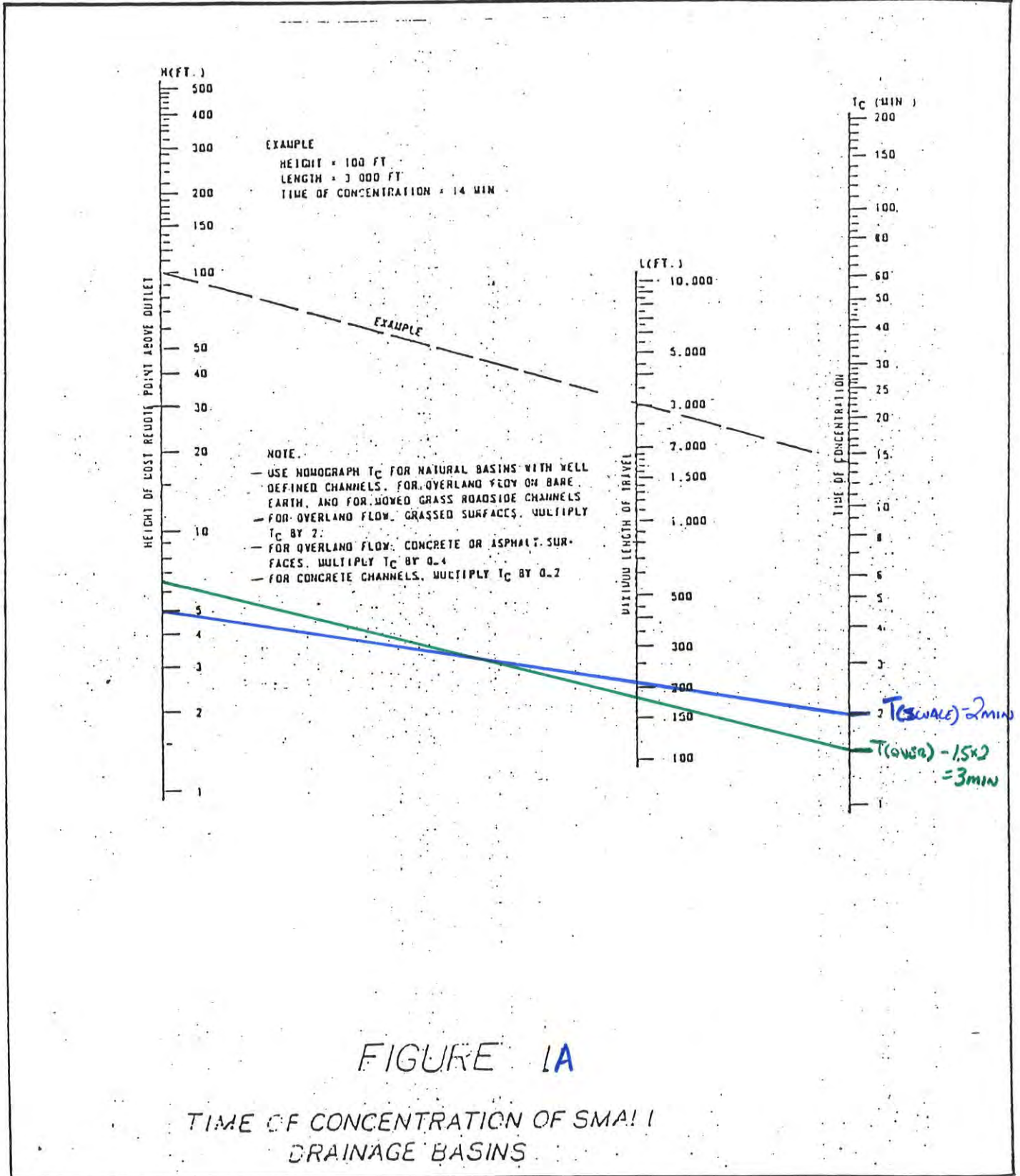
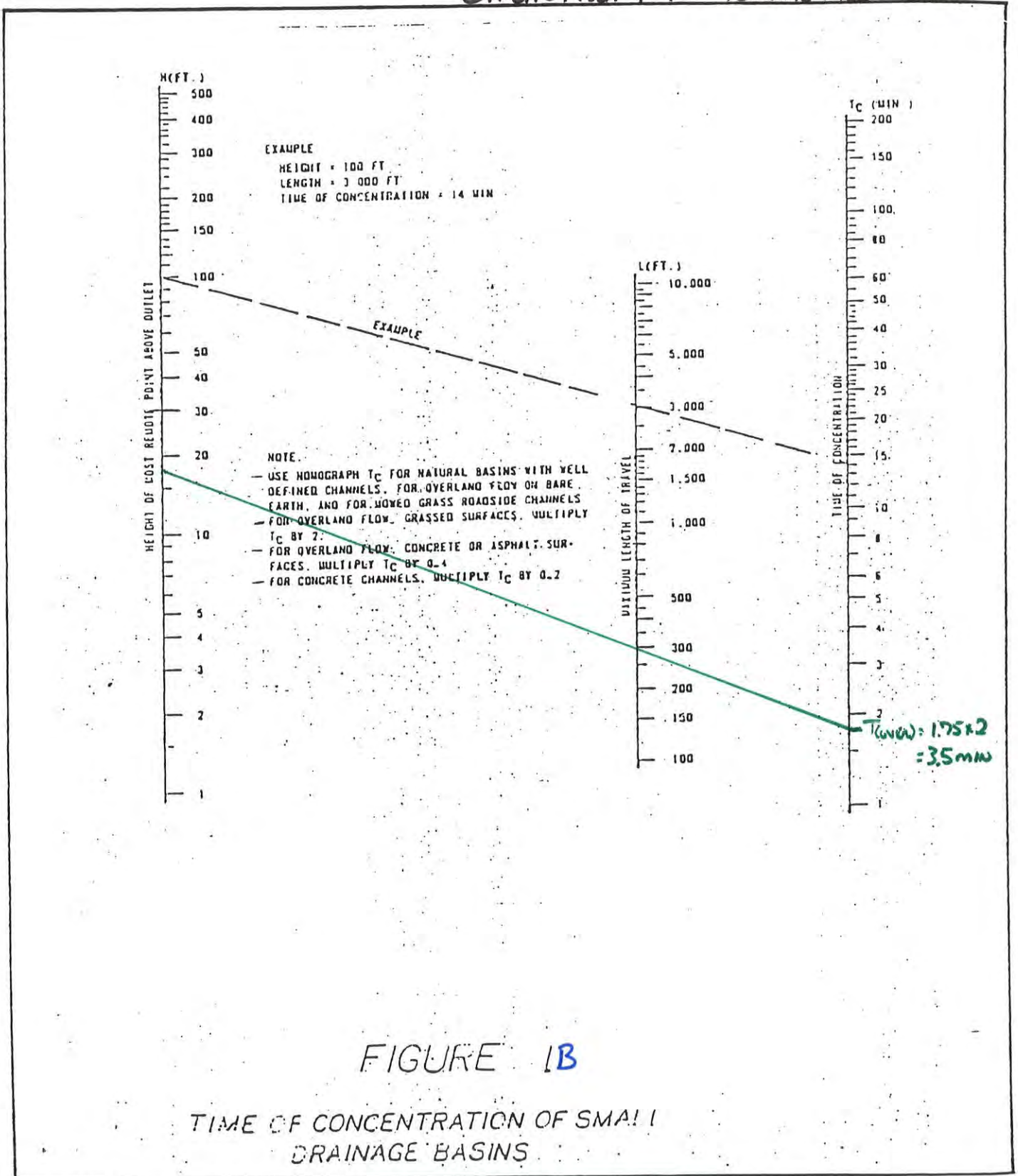

FIGURE 1A

TIME OF CONCENTRATION OF SMALL DRAINAGE BASINS



OFFSITE AREA 4 TO PENNIAL PARK BASIN





OFFSITE AREA 5 TO PENNIAL PARK BASIN

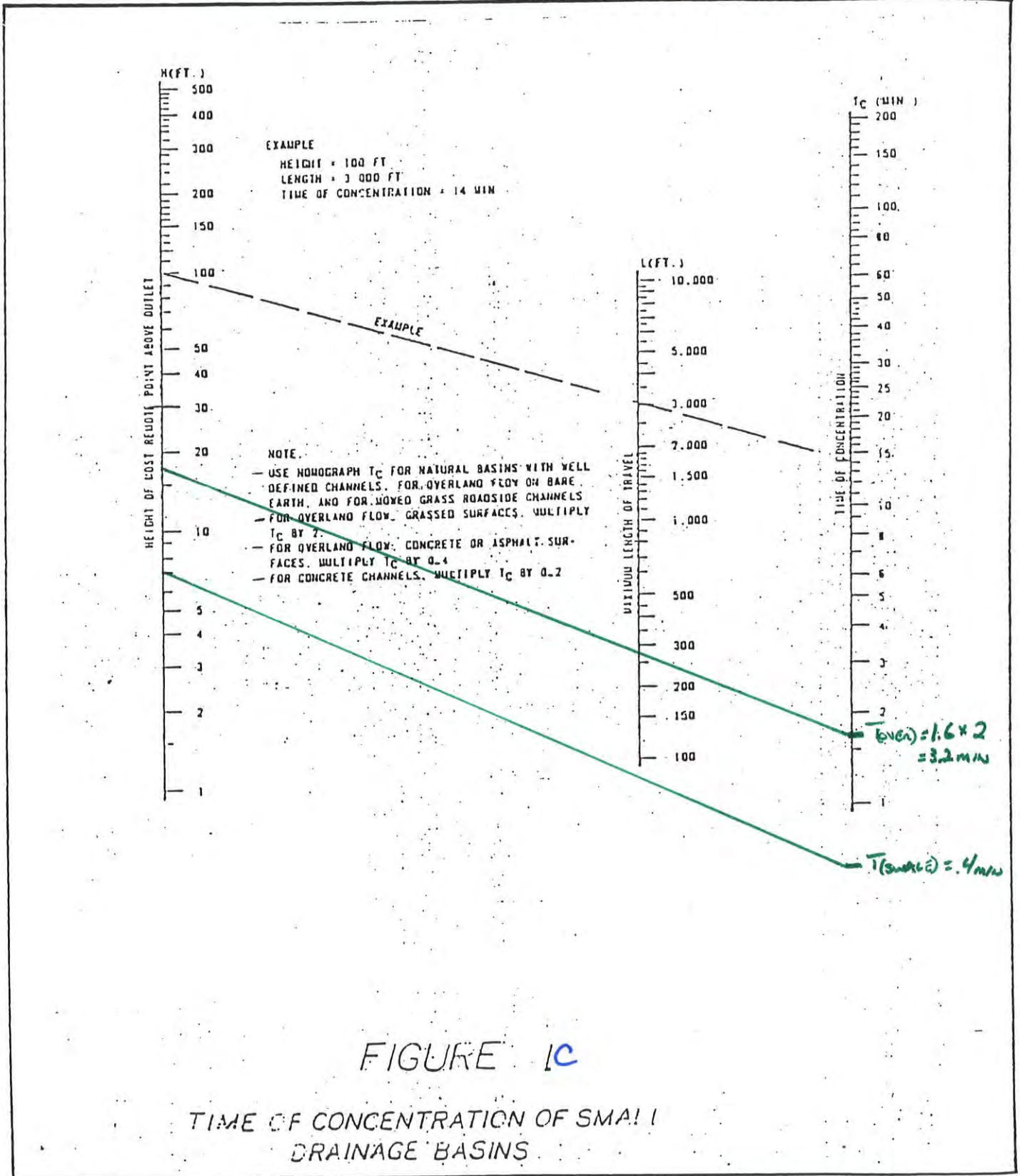



ON-SITE AREA TO AVONDALE HEIGHTS BASIN

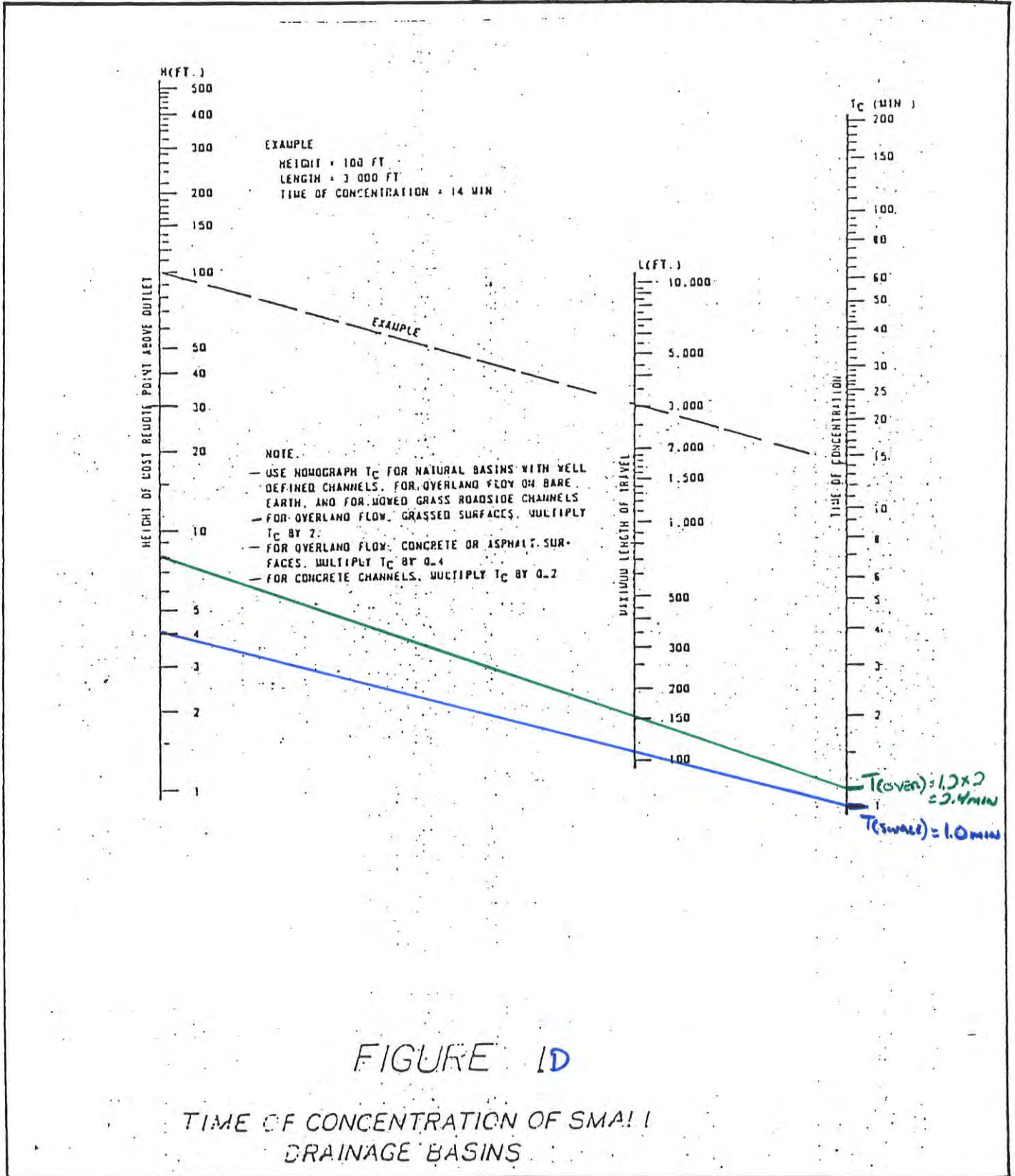

**Structure Details
Avondale Heights
Pennial Park**

TRIPLE AREA INLET PENNIAL PARK RETENTION LAKE

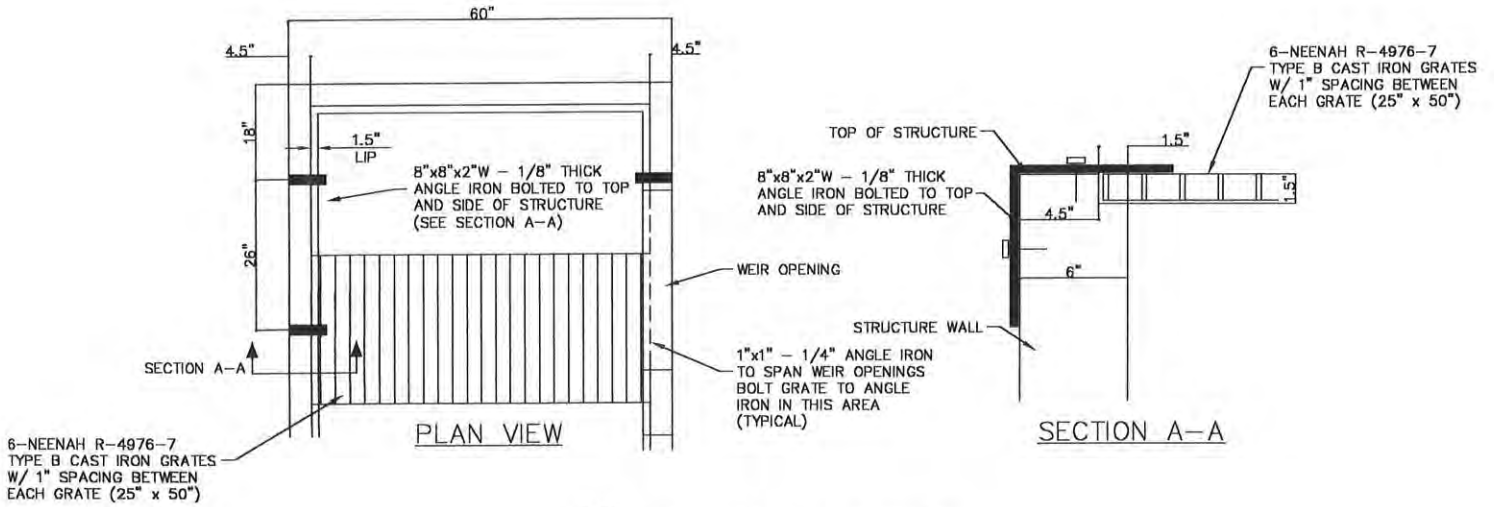
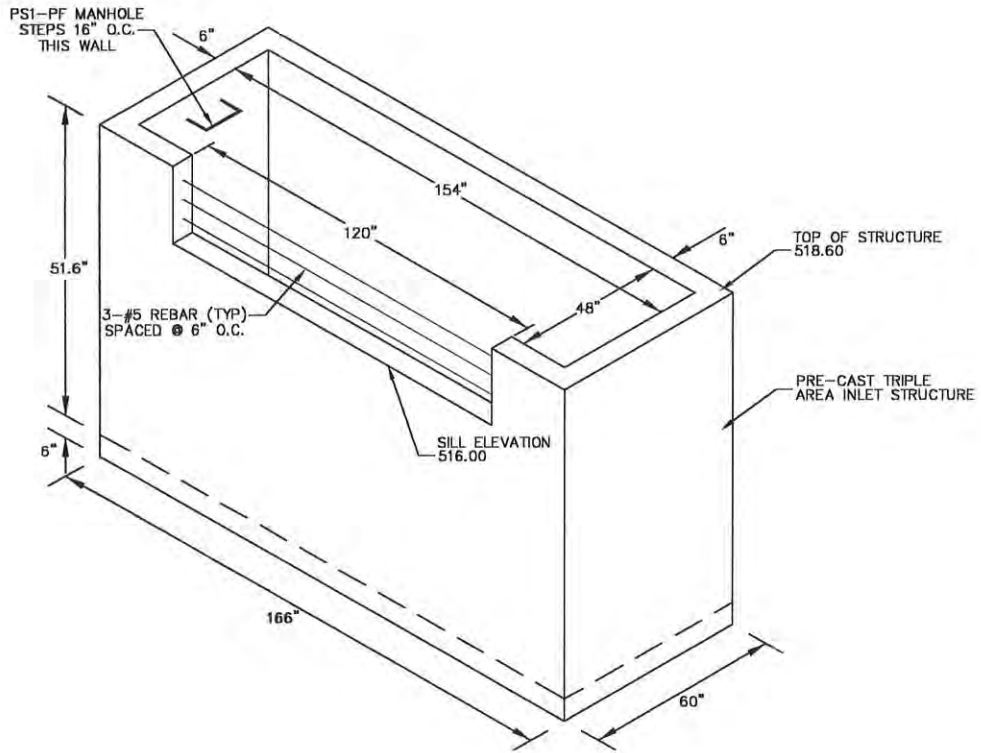

NOTE:
TO ENABLE ACCESS THE GRATE ON THE END OF THE
STRUCTURE WITH THE STEPS SHALL BE LATCHED.

GRATE TOP TYP. FOR EACH TRIPLE AREA INLET

FIGURE 2.

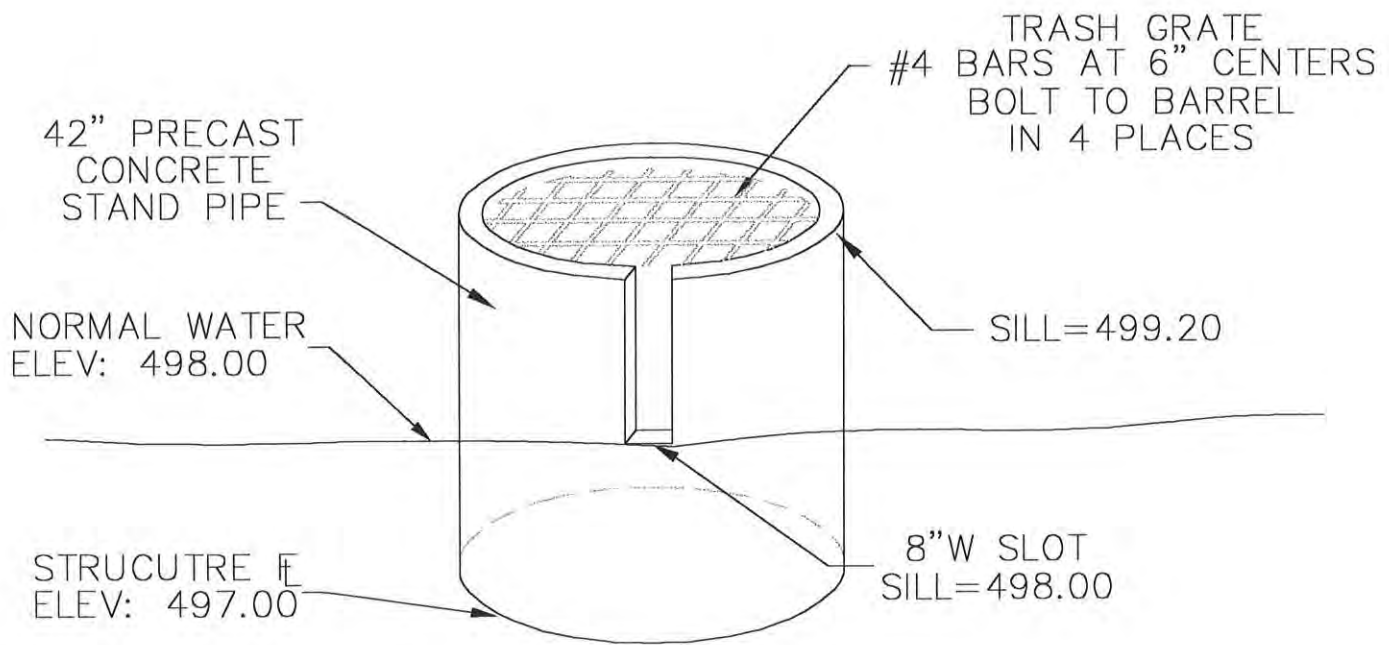

OVERFLOW STRUCTURE DETAIL AVONDALE HEIGHTS

NOT TO SCALE

FIGURE 3.

POND7
Reanalysis of Cherrywood Parc Basin
15, 25 and 100 Year 20 Minute Design Storms

Table of Contents

***** RUNOFF HYDROGRAPHS *****

20 MIN INFLOWS.. A 15YR
 Read HYG 1.01

20 MIN INFLOWS.. B 25YR
 Read HYG 1.04

20 MIN INFLOWS.. C 100Y
 Read HYG 1.07

***** POND VOLUMES *****

CHERRYWOOD..... Vol: Planimeter 2.01

***** OUTLET STRUCTURES *****

CHERRY..... Outlet Input Data 3.01
 Composite Rating Curve 3.04

***** POND ROUTING *****

CHERRYWOOD OUT A 15YR
 Pond Routing Summary 4.01
 Pond Routed HYG (total out) 4.02

CHERRYWOOD OUT B 25YR
 Pond Routing Summary 4.04
 Pond Routed HYG (total out) 4.05

CHERRYWOOD OUT C 100Y
 Pond Routing Summary 4.07
 Pond Routed HYG (total out) 4.08

Type.... Read HYG
 Name.... 20 MIN INFLOWS Tag: A 15YR
 File.... C:\MY DOCUMENTS\CHERRYWOOD.PPW
 Title... 20 Minute Inflows to Cherrywood Parc Basins
 Storm... Tag: A 15YR

HYG file = C:\MY DOCUMENTS\CHERRY15.HYG
 HYG ID = CherryWood 15 In
 HYG Tag = 15yr

 Peak Discharge = 63.37 cfs
 Time to Peak = 20.00 min
 HYG Volume = 76069 cu.ft

HYDROGRAPH ORDINATES (cfs)						
Output Time increment = 1.00 min						
Time min	Time on left represents time for first value in each row.					
.00	.00	3.17	6.34	9.67	12.68	
5.00	15.84	19.01	22.18	25.35	28.52	
10.00	31.69	34.85	38.02	41.19	44.38	
15.00	47.53	50.70	53.86	57.03	60.21	
20.00	63.37	60.21	57.03	53.86	50.70	
25.00	47.53	44.38	41.19	38.02	34.85	
30.00	31.69	28.52	25.35	22.18	19.01	
35.00	15.84	12.68	9.67	6.34	3.17	
40.00	.00	.00	.00	.00	.00	
45.00	.00	.00	.00	.00	.00	
50.00	.00	.00	.00	.00	.00	
55.00	.00	.00	.00	.00	.00	
60.00	.00	.00	.00	.00	.00	
65.00	.00	.00	.00	.00	.00	
70.00	.00	.00	.00	.00	.00	
75.00	.00	.00	.00	.00	.00	
80.00	.00	.00	.00	.00	.00	
85.00	.00	.00	.00	.00	.00	
90.00	.00	.00	.00	.00	.00	
95.00	.00	.00	.00	.00	.00	
100.00	.00	.00	.00	.00	.00	
105.00	.00	.00	.00	.00	.00	
110.00	.00	.00	.00	.00	.00	
115.00	.00	.00	.00	.00	.00	
120.00	.00	.00	.00	.00	.00	
125.00	.00	.00	.00	.00	.00	
130.00	.00	.00	.00	.00	.00	
135.00	.00	.00	.00	.00	.00	
140.00	.00	.00	.00	.00	.00	
145.00	.00	.00	.00	.00	.00	
150.00	.00	.00	.00	.00	.00	
155.00	.00	.00	.00	.00	.00	

Type.... Read HYG
 Name.... 20 MIN INFLOWS Tag: A 15YR
 File.... C:\MY DOCUMENTS\CHERRYWOOD.PPW
 Title... 20 Minute Inflows to Cherrywood Parc Basins
 Storm... Tag: A 15YR

HYDROGRAPH ORDINATES (cfs)
 Output Time increment = 1.00 min
 Time on left represents time for first value in each row.

Time min					
160.00	.00	.00	.00	.00	.00
165.00	.00	.00	.00	.00	.00
170.00	.00	.00	.00	.00	.00
175.00	.00	.00	.00	.00	.00
180.00	.00	.00	.00	.00	.00
185.00	.00	.00	.00	.00	.00
190.00	.00	.00	.00	.00	.00
195.00	.00	.00	.00	.00	.00
200.00	.00	.00	.00	.00	.00
205.00	.00	.00	.00	.00	.00
210.00	.00	.00	.00	.00	.00
215.00	.00	.00	.00	.00	.00
220.00	.00	.00	.00	.00	.00
225.00	.00	.00	.00	.00	.00
230.00	.00	.00	.00	.00	.00
235.00	.00	.00	.00	.00	.00
240.00	.00	.00	.00	.00	.00
245.00	.00	.00	.00	.00	.00
250.00	.00	.00	.00	.00	.00
255.00	.00	.00	.00	.00	.00
260.00	.00	.00	.00	.00	.00
265.00	.00	.00	.00	.00	.00
270.00	.00	.00	.00	.00	.00
275.00	.00	.00	.00	.00	.00
280.00	.00	.00	.00	.00	.00
285.00	.00	.00	.00	.00	.00
290.00	.00	.00	.00	.00	.00
295.00	.00	.00	.00	.00	.00
300.00	.00	.00	.00	.00	.00
305.00	.00	.00	.00	.00	.00
310.00	.00	.00	.00	.00	.00
315.00	.00	.00	.00	.00	.00
320.00	.00	.00	.00	.00	.00
325.00	.00	.00	.00	.00	.00
330.00	.00	.00	.00	.00	.00
335.00	.00	.00	.00	.00	.00
340.00	.00	.00	.00	.00	.00
345.00	.00	.00	.00	.00	.00
350.00	.00	.00	.00	.00	.00
355.00	.00	.00	.00	.00	.00
360.00	.00	.00	.00	.00	.00
365.00	.00	.00	.00	.00	.00
370.00	.00	.00	.00	.00	.00
375.00	.00	.00	.00	.00	.00
380.00	.00	.00	.00	.00	.00
385.00	.00	.00	.00	.00	.00

Type.... Read HYG
 Name.... 20 MIN INFLOWS Tag: A 15YR
 File.... C:\MY DOCUMENTS\CHERRYWOOD.PPW
 Title... 20 Minute Inflows to Cherrywood Parc Basins
 Storm... Tag: A 15YR

HYDROGRAPH ORDINATES (cfs)						
Time min	Output Time increment = 1.00 min					
	Time on left represents time for first value in each row.					
390.00	.00	.00	.00	.00	.00	.00
395.00	.00	.00	.00	.00	.00	.00
400.00	.00	.00	.00	.00	.00	.00
405.00	.00	.00	.00	.00	.00	.00
410.00	.00	.00	.00	.00	.00	.00
415.00	.00	.00	.00	.00	.00	.00
420.00	.00	.00	.00	.00	.00	.00
425.00	.00	.00	.00	.00	.00	.00
430.00	.00	.00	.00	.00	.00	.00
435.00	.00	.00	.00	.00	.00	.00
440.00	.00	.00	.00	.00	.00	.00
445.00	.00	.00	.00	.00	.00	.00
450.00	.00	.00	.00	.00	.00	.00
455.00	.00	.00	.00	.00	.00	.00
460.00	.00	.00	.00	.00	.00	.00
465.00	.00	.00	.00	.00	.00	.00
470.00	.00	.00	.00	.00	.00	.00
475.00	.00	.00	.00	.00	.00	.00
480.00	.00	.00	.00	.00	.00	.00
485.00	.00	.00	.00	.00	.00	.00
490.00	.00	.00	.00	.00	.00	.00
495.00	.00	.00	.00	.00	.00	.00
500.00	.00	.00	.00	.00	.00	.00
505.00	.00	.00	.00	.00	.00	.00
510.00	.00	.00	.00	.00	.00	.00
515.00	.00	.00	.00	.00	.00	.00
520.00	.00	.00	.00	.00	.00	.00
525.00	.00	.00	.00	.00	.00	.00
530.00	.00	.00	.00	.00	.00	.00
535.00	.00	.00	.00	.00	.00	.00
540.00	.00	.00	.00	.00	.00	.00
545.00	.00	.00	.00	.00	.00	.00
550.00	.00	.00	.00	.00	.00	.00
555.00	.00	.00	.00	.00	.00	.00
560.00	.00	.00	.00	.00	.00	.00
565.00	.00	.00	.00	.00	.00	.00
570.00	.00	.00	.00	.00	.00	.00
575.00	.00	.00	.00	.00	.00	.00
580.00	.00	.00	.00	.00	.00	.00
585.00	.00	.00	.00	.00	.00	.00
590.00	.00	.00	.00	.00	.00	.00
595.00	.00	.00	.00	.00	.00	.00
600.00	.00	.00	.00	.00	.00	.00

Type.... Read HYG
 Name.... 20 MIN INFLOWS
 File.... C:\MY DOCUMENTS\CHERRYWOOD.PPW
 Storm... Tag: B 25YR

HYG file = C:\MY DOCUMENTS\CHERRY25.HYG
 HYG ID = Cherrywood 25 in
 HYG Tag = 25yr

 Peak Discharge = 78.33 cfs
 Time to Peak = 20.00 min
 HYG Volume = 94000 cu.ft

HYDROGRAPH ORDINATES (cfs)					
Output Time increment = 1.00 min					
Time min	Time on left represents time for first value in each row.				
.00	.00	3.92	7.83	11.75	15.67
5.00	19.58	23.50	27.42	31.33	35.25
10.00	39.17	43.08	47.00	50.92	54.83
15.00	58.75	62.67	66.58	70.50	74.42
20.00	78.33	74.42	70.50	66.58	62.67
25.00	58.75	54.83	50.92	47.00	43.08
30.00	39.17	35.25	31.33	27.42	23.50
35.00	19.58	15.67	11.75	7.83	3.92
40.00	.00	.00	.00	.00	.00
45.00	.00	.00	.00	.00	.00
50.00	.00	.00	.00	.00	.00
55.00	.00	.00	.00	.00	.00
60.00	.00	.00	.00	.00	.00
65.00	.00	.00	.00	.00	.00
70.00	.00	.00	.00	.00	.00
75.00	.00	.00	.00	.00	.00
80.00	.00	.00	.00	.00	.00
85.00	.00	.00	.00	.00	.00
90.00	.00	.00	.00	.00	.00
95.00	.00	.00	.00	.00	.00
100.00	.00	.00	.00	.00	.00
105.00	.00	.00	.00	.00	.00
110.00	.00	.00	.00	.00	.00
115.00	.00	.00	.00	.00	.00
120.00	.00	.00	.00	.00	.00
125.00	.00	.00	.00	.00	.00
130.00	.00	.00	.00	.00	.00
135.00	.00	.00	.00	.00	.00
140.00	.00	.00	.00	.00	.00
145.00	.00	.00	.00	.00	.00
150.00	.00	.00	.00	.00	.00
155.00	.00	.00	.00	.00	.00
160.00	.00	.00	.00	.00	.00

Type.... Read HYG
 Name.... 20 MIN INFLOWS
 File.... C:\MY DOCUMENTS\CHERRYWOOD.PPW
 Storm... Tag: B 25YR

Page 1.05
 Event: B 25YR

HYDROGRAPH ORDINATES (cfs)
 Output Time increment = 1.00 min
 Time on left represents time for first value in each row.

Time min					
165.00	.00	.00	.00	.00	.00
170.00	.00	.00	.00	.00	.00
175.00	.00	.00	.00	.00	.00
180.00	.00	.00	.00	.00	.00
185.00	.00	.00	.00	.00	.00
190.00	.00	.00	.00	.00	.00
195.00	.00	.00	.00	.00	.00
200.00	.00	.00	.00	.00	.00
205.00	.00	.00	.00	.00	.00
210.00	.00	.00	.00	.00	.00
215.00	.00	.00	.00	.00	.00
220.00	.00	.00	.00	.00	.00
225.00	.00	.00	.00	.00	.00
230.00	.00	.00	.00	.00	.00
235.00	.00	.00	.00	.00	.00
240.00	.00	.00	.00	.00	.00
245.00	.00	.00	.00	.00	.00
250.00	.00	.00	.00	.00	.00
255.00	.00	.00	.00	.00	.00
260.00	.00	.00	.00	.00	.00
265.00	.00	.00	.00	.00	.00
270.00	.00	.00	.00	.00	.00
275.00	.00	.00	.00	.00	.00
280.00	.00	.00	.00	.00	.00
285.00	.00	.00	.00	.00	.00
290.00	.00	.00	.00	.00	.00
295.00	.00	.00	.00	.00	.00
300.00	.00	.00	.00	.00	.00
305.00	.00	.00	.00	.00	.00
310.00	.00	.00	.00	.00	.00
315.00	.00	.00	.00	.00	.00
320.00	.00	.00	.00	.00	.00
325.00	.00	.00	.00	.00	.00
330.00	.00	.00	.00	.00	.00
335.00	.00	.00	.00	.00	.00
340.00	.00	.00	.00	.00	.00
345.00	.00	.00	.00	.00	.00
350.00	.00	.00	.00	.00	.00
355.00	.00	.00	.00	.00	.00
360.00	.00	.00	.00	.00	.00
365.00	.00	.00	.00	.00	.00
370.00	.00	.00	.00	.00	.00
375.00	.00	.00	.00	.00	.00
380.00	.00	.00	.00	.00	.00
385.00	.00	.00	.00	.00	.00
390.00	.00	.00	.00	.00	.00
395.00	.00	.00	.00	.00	.00

Type.... Read HYG
 Name.... 20 MIN INFLOWS
 File.... C:\MY DOCUMENTS\CHERRYWOOD.PPW
 Storm... Tag: B 25YR

Page 1.06
 Event: B 25YR

HYDROGRAPH ORDINATES (cfs)
 Output Time increment = 1.00 min
 Time on left represents time for first value in each row.

Time min					
400.00	.00	.00	.00	.00	.00
405.00	.00	.00	.00	.00	.00
410.00	.00	.00	.00	.00	.00
415.00	.00	.00	.00	.00	.00
420.00	.00	.00	.00	.00	.00
425.00	.00	.00	.00	.00	.00
430.00	.00	.00	.00	.00	.00
435.00	.00	.00	.00	.00	.00
440.00	.00	.00	.00	.00	.00
445.00	.00	.00	.00	.00	.00
450.00	.00	.00	.00	.00	.00
455.00	.00	.00	.00	.00	.00
460.00	.00	.00	.00	.00	.00
465.00	.00	.00	.00	.00	.00
470.00	.00	.00	.00	.00	.00
475.00	.00	.00	.00	.00	.00
480.00	.00	.00	.00	.00	.00
485.00	.00	.00	.00	.00	.00
490.00	.00	.00	.00	.00	.00
495.00	.00	.00	.00	.00	.00
500.00	.00	.00	.00	.00	.00
505.00	.00	.00	.00	.00	.00
510.00	.00	.00	.00	.00	.00
515.00	.00	.00	.00	.00	.00
520.00	.00	.00	.00	.00	.00
525.00	.00	.00	.00	.00	.00
530.00	.00	.00	.00	.00	.00
535.00	.00	.00	.00	.00	.00
540.00	.00	.00	.00	.00	.00
545.00	.00	.00	.00	.00	.00
550.00	.00	.00	.00	.00	.00
555.00	.00	.00	.00	.00	.00
560.00	.00	.00	.00	.00	.00
565.00	.00	.00	.00	.00	.00
570.00	.00	.00	.00	.00	.00
575.00	.00	.00	.00	.00	.00
580.00	.00	.00	.00	.00	.00
585.00	.00	.00	.00	.00	.00
590.00	.00	.00	.00	.00	.00
595.00	.00	.00	.00	.00	.00
600.00	.00	.00	.00	.00	.00

Type... Read HYG
 Name... 20 MIN INFLOWS
 File... C:\MY DOCUMENTS\CHERRYWOOD.PPW
 Storm... Tag: C 100Y

HYG file = C:\MY DOCUMENTS\CHERY100.HYG
 HYG ID = Cherrywood 100
 HYG Tag = 100yr

 Peak Discharge = 110.87 cfs
 Time to Peak = 20.00 min
 HYG Volume = 133040 cu.ft

HYDROGRAPH ORDINATES (cfs)
 Output Time increment = 1.00 min
 Time on left represents time for first value in each row.

Time min	Time on left represents time for first value in each row.				
.00	.00	5.54	11.09	16.63	22.17
5.00	27.72	33.26	38.80	44.35	49.89
10.00	55.43	60.98	66.52	72.06	77.61
15.00	83.15	88.69	94.24	99.78	105.32
20.00	110.87	105.32	99.78	94.24	88.69
25.00	83.15	77.61	72.06	66.52	60.98
30.00	55.43	49.89	44.35	38.80	33.26
35.00	27.72	22.17	16.63	11.09	5.54
40.00	.00	.00	.00	.00	.00
45.00	.00	.00	.00	.00	.00
50.00	.00	.00	.00	.00	.00
55.00	.00	.00	.00	.00	.00
60.00	.00	.00	.00	.00	.00
65.00	.00	.00	.00	.00	.00
70.00	.00	.00	.00	.00	.00
75.00	.00	.00	.00	.00	.00
80.00	.00	.00	.00	.00	.00
85.00	.00	.00	.00	.00	.00
90.00	.00	.00	.00	.00	.00
95.00	.00	.00	.00	.00	.00
100.00	.00	.00	.00	.00	.00
105.00	.00	.00	.00	.00	.00
110.00	.00	.00	.00	.00	.00
115.00	.00	.00	.00	.00	.00
120.00	.00	.00	.00	.00	.00
125.00	.00	.00	.00	.00	.00
130.00	.00	.00	.00	.00	.00
135.00	.00	.00	.00	.00	.00
140.00	.00	.00	.00	.00	.00
145.00	.00	.00	.00	.00	.00
150.00	.00	.00	.00	.00	.00
155.00	.00	.00	.00	.00	.00
160.00	.00	.00	.00	.00	.00

Type... Read HYG
 Name... 20 MIN INFLOWS
 File... C:\MY DOCUMENTS\CHERRYWOOD.PPW
 Storm... Tag: C 100Y

HYDROGRAPH ORDINATES (cfs)
 Output Time increment = 1.00 min
 Time on left represents time for first value in each row.

Time min					
165.00	.00	.00	.00	.00	.00
170.00	.00	.00	.00	.00	.00
175.00	.00	.00	.00	.00	.00
180.00	.00	.00	.00	.00	.00
185.00	.00	.00	.00	.00	.00
190.00	.00	.00	.00	.00	.00
195.00	.00	.00	.00	.00	.00
200.00	.00	.00	.00	.00	.00
205.00	.00	.00	.00	.00	.00
210.00	.00	.00	.00	.00	.00
215.00	.00	.00	.00	.00	.00
220.00	.00	.00	.00	.00	.00
225.00	.00	.00	.00	.00	.00
230.00	.00	.00	.00	.00	.00
235.00	.00	.00	.00	.00	.00
240.00	.00	.00	.00	.00	.00
245.00	.00	.00	.00	.00	.00
250.00	.00	.00	.00	.00	.00
255.00	.00	.00	.00	.00	.00
260.00	.00	.00	.00	.00	.00
265.00	.00	.00	.00	.00	.00
270.00	.00	.00	.00	.00	.00
275.00	.00	.00	.00	.00	.00
280.00	.00	.00	.00	.00	.00
285.00	.00	.00	.00	.00	.00
290.00	.00	.00	.00	.00	.00
295.00	.00	.00	.00	.00	.00
300.00	.00	.00	.00	.00	.00
305.00	.00	.00	.00	.00	.00
310.00	.00	.00	.00	.00	.00
315.00	.00	.00	.00	.00	.00
320.00	.00	.00	.00	.00	.00
325.00	.00	.00	.00	.00	.00
330.00	.00	.00	.00	.00	.00
335.00	.00	.00	.00	.00	.00
340.00	.00	.00	.00	.00	.00
345.00	.00	.00	.00	.00	.00
350.00	.00	.00	.00	.00	.00
355.00	.00	.00	.00	.00	.00
360.00	.00	.00	.00	.00	.00
365.00	.00	.00	.00	.00	.00
370.00	.00	.00	.00	.00	.00
375.00	.00	.00	.00	.00	.00
380.00	.00	.00	.00	.00	.00
385.00	.00	.00	.00	.00	.00
390.00	.00	.00	.00	.00	.00
395.00	.00	.00	.00	.00	.00

Type.... Read HYG
 Name.... 20 MIN INFLOWS
 File.... C:\MY DOCUMENTS\CHERRYWOOD.PPW
 Storm... Tag: C 100Y

Page 1.09
 Event: C 100YR

HYDROGRAPH ORDINATES (cfs)						
Time min	Output Time increment = 1.00 min					
	Time on left represents time for first value in each row.					
400.00	.00	.00	.00	.00	.00	.00
405.00	.00	.00	.00	.00	.00	.00
410.00	.00	.00	.00	.00	.00	.00
415.00	.00	.00	.00	.00	.00	.00
420.00	.00	.00	.00	.00	.00	.00
425.00	.00	.00	.00	.00	.00	.00
430.00	.00	.00	.00	.00	.00	.00
435.00	.00	.00	.00	.00	.00	.00
440.00	.00	.00	.00	.00	.00	.00
445.00	.00	.00	.00	.00	.00	.00
450.00	.00	.00	.00	.00	.00	.00
455.00	.00	.00	.00	.00	.00	.00
460.00	.00	.00	.00	.00	.00	.00
465.00	.00	.00	.00	.00	.00	.00
470.00	.00	.00	.00	.00	.00	.00
475.00	.00	.00	.00	.00	.00	.00
480.00	.00	.00	.00	.00	.00	.00
485.00	.00	.00	.00	.00	.00	.00
490.00	.00	.00	.00	.00	.00	.00
495.00	.00	.00	.00	.00	.00	.00
500.00	.00	.00	.00	.00	.00	.00
505.00	.00	.00	.00	.00	.00	.00
510.00	.00	.00	.00	.00	.00	.00
515.00	.00	.00	.00	.00	.00	.00
520.00	.00	.00	.00	.00	.00	.00
525.00	.00	.00	.00	.00	.00	.00
530.00	.00	.00	.00	.00	.00	.00
535.00	.00	.00	.00	.00	.00	.00
540.00	.00	.00	.00	.00	.00	.00
545.00	.00	.00	.00	.00	.00	.00
550.00	.00	.00	.00	.00	.00	.00
555.00	.00	.00	.00	.00	.00	.00
560.00	.00	.00	.00	.00	.00	.00
565.00	.00	.00	.00	.00	.00	.00
570.00	.00	.00	.00	.00	.00	.00
575.00	.00	.00	.00	.00	.00	.00
580.00	.00	.00	.00	.00	.00	.00
585.00	.00	.00	.00	.00	.00	.00
590.00	.00	.00	.00	.00	.00	.00
595.00	.00	.00	.00	.00	.00	.00
600.00	.00	.00	.00	.00	.00	.00

Type.... Vol: Planimeter
Name.... CHERRYWOOD

Page 2.01

File.... C:\MY DOCUMENTS\CHERRYWOOD.PPW
Title... Cherrywood Parc Phase 5 Basin

POND VOLUME CALCULATIONS

Planimeter scale: 1.00 ft/in

Elevation (ft)	Planimeter (sq.in)	Area (acres)	A1+A2+sq(A1*A2) (acres)	Volume (cu.ft)	Volume Sum (cu.ft)
548.70	.000	.0000	.0000	0	0
550.00	10564.000	.2425	.2425	4578	4578
552.00	14833.000	.3405	.8704	25277	29854
554.00	18557.000	.4260	1.1474	33321	63175
556.00	22508.000	.5167	1.4119	41002	104176

POND VOLUME EQUATIONS

* Incremental volume computed by the Conic Method for Reservoir Volumes.

$$\text{Volume} = (1/3) * (\text{EL2}-\text{EL1}) * (\text{Area1} + \text{Area2} + \text{sq.rt.}(\text{Area1}*\text{Area2}))$$

where: EL1, EL2 = Lower and upper elevations of the increment
Area1, Area2 = Areas computed for EL1, EL2, respectively
Volume = Incremental volume between EL1 and EL2

Type... Outlet Input Data
Name... CHERRY

File... C:\MY DOCUMENTS\CHERRYWOOD.PPW
Title... Cherrywood Parc Outflow Structure

REQUESTED POND WS ELEVATIONS:

Min. Elev.= 548.70 ft
Increment = .30 ft
Max. Elev.= 556.00 ft

OUTLET CONNECTIVITY

---> Forward Flow Only (UpStream to DnStream)
<--- Reverse Flow Only (DnStream to UpStream)
<---> Forward and Reverse Both Allowed

Structure	No.		Outfall	E1, ft	E2, ft
Inlet Box	AI	--->	CV	553.590	556.000
Orifice-Area	SI	--->	CV	550.700	556.000
Weir-Rectangular	LS	--->	CV	548.700	550.700
Culvert-Circular	CV	--->	TW	548.700	556.000
TW SETUP, DS Channel					

Type... Outlet Input Data
Name... CHERRY

File... C:\MY DOCUMENTS\CHERRYWOOD.PPW
Title... Cherrywood Parc Outflow Structure

OUTLET STRUCTURE INPUT DATA

Structure ID = AI
Structure Type = Inlet Box

of Openings = 1
Invert Elev. = 553.59 ft
Orifice Area = 6.2500 sq.ft
Orifice Coeff = .600
Weir Length = 10.00 ft
Weir Coeff. = 3.000
K, Submerged = .000
K, Reverse = 1.000
Kb, Barrel = .000000 (per ft of full flow)
Barrel Length = .00 ft
Mannings n = .0000

Structure ID = SL
Structure Type = Orifice-Area

of Openings = 1
Invert Elev. = 548.70 ft
Area = 2.0000 sq.ft
Top of Orifice = 550.70 ft
Datum Elev. = 549.70 ft
Orifice Coeff. = .600

Structure ID = LS
Structure Type = Weir-Rectangular

of Openings = 1
Crest Elev. = 548.70 ft
Weir Length = 1.00 ft
Weir Coeff. = 3.000000

Weir TW effects (Use adjustment equation)

Type.... Outlet Input Data
Name.... CHERRY

File.... C:\MY DOCUMENTS\CHERRYWOOD.PPW
Title... Cherrywood Parc Outflow Structure

OUTLET STRUCTURE INPUT DATA

Structure ID = CV
Structure Type = Culvert-Circular

No. Barrels = 1
Barrel Diameter = 3.0000 ft
Upstream Invert = 548.70 ft
Dnstream Invert = 547.80 ft
Horiz. Length = 50.57 ft
Barrel Length = 50.58 ft
Barrel Slope = .01780 ft/ft

OUTLET CONTROL DATA...

Mannings n = .0130
Ke = .5000 (forward entrance loss)
Kb = .007228 (per ft of full flow)
Kr = .5000 (reverse entrance loss)
HW Convergence = .100 +/- ft

INLET CONTROL DATA

Equation form = 1
Inlet Control K = .0078
Inlet Control M = 2.0000
Inlet Control c = .02920
Inlet Control Y = .7400
T1 ratio (HW/D) = 1.127
T2 ratio (HW/D) = 1.198
Slope Factor = -.500

Use unsubmerged inlet control Form 1 equ. below T1 elev.
Use submerged inlet control Form 1 equ. above T2 elev.

In transition zone between unsubmerged and submerged inlet control,
interpolate between flows at T1 & T2...

At T1 Elev = 552.08 ft ---> Flow = 42.85 cfs
At T2 Elev = 552.29 ft ---> Flow = 48.97 cfs

Structure ID = TW
Structure Type = TW SETUP, DS Channel

FREE OUTFALL CONDITIONS SPECIFIED

CONVERGENCE TOLERANCES...

Maximum Iterations = 15
Min. TW tolerance = .10 ft
Max. TW tolerance = .10 ft
Min. HW tolerance = .10 ft
Max. HW tolerance = .10 ft
Min. Q tolerance = .10 cfs
Max. Q tolerance = .10 cfs

File... C:\MY DOCUMENTS\CHERRYWOOD.PPW
 Title... Cherrywood Parc Outflow Structure

***** COMPOSITE OUTFLOW SUMMARY *****

WS Elev.	Total Q		Converge	Notes
Elev. ft	Q cfs	TW Elev ft	Error +/-ft	Contributing Structures
548.70	.00	Free Outfall		(no Q: AI,SL,LS,CV)
549.00	.17	Free Outfall		LS,CV (no Q: AI,SL)
549.30	.78	Free Outfall		LS,CV (no Q: AI,SL)
549.60	1.97	Free Outfall		LS,CV (no Q: AI,SL)
549.90	3.05	Free Outfall		LS,CV (no Q: AI,SL)
550.20	4.30	Free Outfall		LS,CV (no Q: AI,SL)
550.50	5.72	Free Outfall		LS,CV (no Q: AI,SL)
550.80	7.86	Free Outfall		SL,CV (no Q: AI,LS)
551.10	9.05	Free Outfall		SL,CV (no Q: AI,LS)
551.40	10.57	Free Outfall		SL,CV (no Q: AI,LS)
551.70	11.46	Free Outfall		SL,CV (no Q: AI,LS)
552.00	12.33	Free Outfall		SL,CV (no Q: AI,LS)
552.30	13.16	Free Outfall		SL,CV (no Q: AI,LS)
552.60	13.96	Free Outfall		SL,CV (no Q: AI,LS)
552.90	14.73	Free Outfall		SL,CV (no Q: AI,LS)
553.20	15.47	Free Outfall		SL,CV (no Q: AI,LS)
553.50	16.19	Free Outfall		SL,CV (no Q: AI,LS)
553.59	16.40	Free Outfall		SL,CV (no Q: AI,LS)
553.80	19.33	Free Outfall		AI,SL,CV (no Q: LS)
554.10	26.90	Free Outfall		AI,SL,CV (no Q: LS)
554.40	37.05	Free Outfall		AI,SL,CV (no Q: LS)
554.70	46.25	Free Outfall		AI,SL,CV (no Q: LS)
555.00	50.16	Free Outfall		AI,SL,CV (no Q: LS)
555.30	54.01	Free Outfall		AI,SL,CV (no Q: LS)
555.60	66.03	Free Outfall		AI,CV (no Q: SL,LS)
555.90	69.69	Free Outfall		AI,CV (no Q: SL,LS)
556.00	70.86	Free Outfall		AI,CV (no Q: SL,LS)

Type... Pond Routing Summary
Name... CHERRYWOOD OUT Tag: A 15YR
File... C:\MY DOCUMENTS\CHERRYWOOD.PPW
Storm... A 15YR Tag: A 15YR

Page 1.01
Event: A 15YR

LEVEL POOL ROUTING SUMMARY

HYG Dir = C:\MY DOCUMENTS\
Inflow HYG file = NONE STORED - CHERRYWOOD IN A 15YR
Outflow HYG file = NONE STORED - CHERRYWOOD OUT A 15YR

Pond Node Data = CHERRYWOOD
Pond Volume Data = CHERRYWOOD
Pond Outlet Data = CHERRY

No Infiltration

INITIAL CONDITIONS

Starting WS Elev = 548.70 ft
Starting Volume = 0 cu.ft
Starting Outflow = .00 cfs
Starting Infiltr. = .00 cfs
Starting Total Qout = .00 cfs
Time Increment = 1.00 min

INFLOW/OUTFLOW HYDROGRAPH SUMMARY

=====
Peak Inflow = 63.37 cfs at 20.00 min
Peak Outflow = 16.08 cfs at 35.00 min

Peak Elevation = 553.46 ft
Peak Storage = 53358 cu.ft
=====

MASS BALANCE (cu.ft)

+ Initial Vol = 0
+ HYG Vol IN = 76069
- Infiltration = 0
- HYG Vol OUT = 76068
- Retained Vol = 0

Unrouted Vol = -1 cu.ft (.001% of Inflow Volume)

Type... Pond Routed HYG (total out)
 Name... CHERRYWOOD OUT Tag: A 15YR
 File... C:\MY DOCUMENTS\CHERRYWOOD.PPW
 Storm... A 15YR Tag: A 15YR

Page 1.02
 Event: A 15YR

POND ROUTED TOTAL OUTFLOW HYG...

HYG file =
 HYG ID = CHERRYWOOD OUT
 HYG Tag = A 15YR

 Peak Discharge = 16.08 cfs
 Time to Peak = 35.00 min
 HYG Volume = 76068 cu.ft

HYDROGRAPH ORDINATES (cfs)

Output Time increment = 1.00 min
 Time on left represents time for first value in each row.

Time min					
.00	.00	.22	.62	1.14	1.79
5.00	2.26	2.73	3.23	3.72	4.27
10.00	4.91	5.61	6.66	7.82	8.50
15.00	9.24	10.15	10.87	11.45	12.01
20.00	12.58	13.12	13.58	14.01	14.37
25.00	14.70	14.98	15.22	15.44	15.61
30.00	15.76	15.88	15.97	16.04	16.07
35.00	16.08	16.07	16.03	15.96	15.87
40.00	15.75	15.62	15.49	15.36	15.22
45.00	15.09	14.95	14.82	14.69	14.55
50.00	14.41	14.27	14.14	14.00	13.86
55.00	13.72	13.58	13.44	13.31	13.17
60.00	13.03	12.89	12.75	12.61	12.47
65.00	12.33	12.19	12.04	11.90	11.76
70.00	11.62	11.48	11.33	11.19	11.04
75.00	10.90	10.76	10.62	10.42	10.18
80.00	9.95	9.72	9.50	9.28	9.07
85.00	8.89	8.73	8.56	8.40	8.24
90.00	8.09	7.94	7.72	7.45	7.19
95.00	6.93	6.69	6.45	6.22	6.00
100.00	5.79	5.62	5.48	5.35	5.21
105.00	5.09	4.96	4.84	4.72	4.60
110.00	4.49	4.38	4.27	4.17	4.07
115.00	3.97	3.88	3.78	3.69	3.61
120.00	3.52	3.44	3.35	3.27	3.20
125.00	3.12	3.05	2.95	2.86	2.77
130.00	2.69	2.61	2.53	2.45	2.37
135.00	2.30	2.23	2.16	2.09	2.03
140.00	1.97	1.84	1.72	1.61	1.51
145.00	1.41	1.32	1.24	1.16	1.08
150.00	1.01	.95	.89	.83	.77
155.00	.71	.64	.59	.54	.49
160.00	.44	.41	.37	.34	.31

Type.... Pond Routed HYG (total out)
Name.... CHERRYWOOD OUT Tag: A 15YR
File.... C:\MY DOCUMENTS\CHERRYWOOD.PPW
Storm... A 15YR Tag: A 15YR

Page 1.03
Event: A 15YR

HYDROGRAPH ORDINATES (cfs)
Output Time increment = 1.00 min
Time on left represents time for first value in each row.

Time min					
165.00	.28	.26	.23	.21	.19
170.00	.18	.15	.12	.10	.09
175.00	.07	.06	.05	.04	.03
180.00	.03	.02	.02	.02	.01
185.00	.01	.01	.01	.01	.01
190.00	.00	.00	.00	.00	

Type.... Pond Routing Summary
Name.... CHERRYWOOD OUT Tag: B 25YR
File.... C:\MY DOCUMENTS\CHERRYWOOD.PPW
Storm... B 25YR Tag: B 25YR

Page 1.04
Event: B 25YR

LEVEL POOL ROUTING SUMMARY

HYG Dir = C:\MY DOCUMENTS\
Inflow HYG file = NONE STORED - CHERRYWOOD IN B 25YR
Outflow HYG file = NONE STORED - CHERRYWOOD OUT B 25YR

Pond Node Data = CHERRYWOOD
Pond Volume Data = CHERRYWOOD
Pond Outlet Data = CHERRY

No Infiltration

INITIAL CONDITIONS

Starting WS Elev = 548.70 ft
Starting Volume = 0 cu.ft
Starting Outflow = .00 cfs
Starting Infiltr. = .00 cfs
Starting Total Qout = .00 cfs
Time Increment = 1.00 min

INFLOW/OUTFLOW HYDROGRAPH SUMMARY

=====
Peak Inflow = 78.33 cfs at 20.00 min
Peak Outflow = 26.79 cfs at 33.00 min

Peak Elevation = 554.10 ft
Peak Storage = 64953 cu.ft
=====

MASS BALANCE (cu.ft)

+ Initial Vol = 0
+ HYG Vol IN = 94000
- Infiltration = 0
- HYG Vol OUT = 93999
- Retained Vol = 0

Unrouted Vol = -1 cu.ft (.001% of Inflow Volume)

Type... Pond Routed HYG (total out)
 Name... CHERRYWOOD OUT Tag: B 25YR
 File... C:\MY DOCUMENTS\CHERRYWOOD.PPW
 Storm... B 25YR Tag: B 25YR

Page 1.05
 Event: B 25YR

POND ROUTED TOTAL OUTFLOW HYG...

HYG file =
 HYG ID = CHERRYWOOD OUT
 HYG Tag = B 25YR

Peak Discharge = 26.79 cfs
 Time to Peak = 33.00 min
 HYG Volume = 93999 cu.ft

HYDROGRAPH ORDINATES (cfs)

Output Time increment = 1.00 min
 Time on left represents time for first value in each row.

Time min	0.00	2.26	4.52	6.78	9.04
.00	.00	.26	.75	1.34	2.05
5.00	2.53	3.10	3.63	4.24	4.96
10.00	5.77	7.03	8.13	8.90	9.88
15.00	10.78	11.43	12.06	12.70	13.34
20.00	13.98	14.57	15.09	15.56	15.97
25.00	16.33	17.83	19.50	21.82	23.65
30.00	25.03	25.99	26.56	26.79	26.68
35.00	26.28	25.59	24.66	23.49	22.10
40.00	20.51	19.08	18.21	17.38	16.59
45.00	16.30	16.17	16.04	15.91	15.77
50.00	15.64	15.51	15.38	15.24	15.11
55.00	14.98	14.84	14.71	14.57	14.43
60.00	14.30	14.16	14.03	13.89	13.75
65.00	13.61	13.47	13.33	13.20	13.06
70.00	12.91	12.77	12.63	12.49	12.36
75.00	12.21	12.07	11.93	11.78	11.64
80.00	11.51	11.36	11.21	11.07	10.93
85.00	10.79	10.65	10.46	10.22	9.99
90.00	9.76	9.54	9.32	9.11	8.93
95.00	8.76	8.59	8.43	8.27	8.12
100.00	7.96	7.78	7.50	7.23	6.98
105.00	6.73	6.49	6.26	6.04	5.82
110.00	5.65	5.51	5.37	5.24	5.11
115.00	4.98	4.86	4.74	4.62	4.51
120.00	4.40	4.29	4.18	4.09	3.99
125.00	3.89	3.80	3.71	3.62	3.54
130.00	3.45	3.37	3.29	3.21	3.13
135.00	3.06	2.97	2.88	2.79	2.70
140.00	2.62	2.54	2.46	2.39	2.31
145.00	2.24	2.17	2.11	2.04	1.98
150.00	1.87	1.75	1.63	1.53	1.43
155.00	1.34	1.25	1.17	1.10	1.02
160.00	.96	.90	.84	.79	.72

Type... Pond Routed HYG (total out)
 Name... CHERRYWOOD OUT Tag: B 25YR
 File... C:\MY DOCUMENTS\CHERRYWOOD.PPW
 Storm... B 25YR Tag: B 25YR

HYDROGRAPH ORDINATES (cfs)
 Output Time increment = 1.00 min
 Time on left represents time for first value in each row.

Time min					
165.00	.65	.60	.54	.50	.45
170.00	.41	.38	.34	.31	.28
175.00	.26	.24	.22	.20	.18
180.00	.16	.13	.11	.09	.07
185.00	.06	.05	.04	.04	.03
190.00	.02	.02	.02	.01	.01
195.00	.01	.01	.01	.01	.00
200.00	.00	.00	.00		

Type.... Pond Routing Summary
Name.... CHERRYWOOD OUT Tag: C 100Y
File.... C:\MY DOCUMENTS\CHERRYWOOD.PPW
Storm... C 100YR Tag: C 100Y

Page 1.07
Event: C 100YR

LEVEL POOL ROUTING SUMMARY

HYG Dir = C:\MY DOCUMENTS\
Inflow HYG file = NONE STORED - CHERRYWOOD IN C 100Y
Outflow HYG file = NONE STORED - CHERRYWOOD OUT C 100Y

Pond Node Data = CHERRYWOOD
Pond Volume Data = CHERRYWOOD
Pond Outlet Data = CHERRY

No Infiltration

INITIAL CONDITIONS

Starting WS Elev = 548.70 ft
Starting Volume = 0 cu.ft
Starting Outflow = .00 cfs
Starting Infiltr. = .00 cfs
Starting Total Qout = .00 cfs
Time Increment = 1.00 min

INFLOW/OUTFLOW HYDROGRAPH SUMMARY

=====
Peak Inflow = 110.87 cfs at 20.00 min
Peak Outflow = 50.13 cfs at 31.00 min

Peak Elevation = 555.00 ft
Peak Storage = 82643 cu.ft
=====

MASS BALANCE (cu.ft)

+ Initial Vol = 0
+ HYG Vol IN = 133040
- Infiltration = 0
- HYG Vol OUT = 133039
- Retained Vol = 0

Unrouted Vol = -1 cu.ft (.001% of Inflow Volume)

Type... Pond Routed HYG (total out)
 Name... CHERRYWOOD OUT Tag: C 100Y
 File... C:\MY DOCUMENTS\CHERRYWOOD.PPW
 Storm... C 100YR Tag: C 100Y

Page 1.08
 Event: C 100YR

POND ROUTED TOTAL OUTFLOW HYG...

HYG file =
 HYG ID = CHERRYWOOD OUT
 HYG Tag = C 100Y

 Peak Discharge = 50.13 cfs
 Time to Peak = 31.00 min
 HYG Volume = 133039 cu.ft

HYDROGRAPH ORDINATES (cfs)

Output Time increment = 1.00 min
 Time on left represents time for first value in each row.

Time min					
.00	.00	.33	.96	1.79	2.42
5.00	3.10	3.75	4.53	5.45	6.81
10.00	8.17	9.12	10.37	11.22	11.99
15.00	12.77	13.54	14.30	15.06	15.81
20.00	17.32	23.00	29.94	36.73	41.68
25.00	45.65	47.31	48.36	49.15	49.71
30.00	50.03	50.13	50.01	49.69	49.18
35.00	48.47	47.57	46.51	43.92	40.73
40.00	37.32	33.58	30.18	27.13	24.94
45.00	22.97	21.16	19.50	18.54	17.69
50.00	16.89	16.35	16.22	16.09	15.96
55.00	15.83	15.69	15.56	15.43	15.30
60.00	15.16	15.03	14.89	14.76	14.62
65.00	14.49	14.35	14.21	14.08	13.94
70.00	13.80	13.66	13.52	13.39	13.25
75.00	13.11	12.97	12.83	12.69	12.55
80.00	12.41	12.27	12.12	11.98	11.84
85.00	11.70	11.56	11.42	11.27	11.12
90.00	10.98	10.84	10.70	10.56	10.32
95.00	10.08	9.85	9.62	9.40	9.19
100.00	8.99	8.82	8.66	8.49	8.33
105.00	8.18	8.02	7.87	7.60	7.33
110.00	7.07	6.82	6.58	6.35	6.12
115.00	5.90	5.70	5.56	5.42	5.29
120.00	5.16	5.03	4.91	4.78	4.67
125.00	4.55	4.44	4.33	4.22	4.12
130.00	4.02	3.93	3.84	3.74	3.65
135.00	3.57	3.48	3.40	3.32	3.24
140.00	3.16	3.09	3.00	2.91	2.82
145.00	2.74	2.65	2.57	2.49	2.41
150.00	2.34	2.27	2.20	2.13	2.07
155.00	2.00	1.91	1.79	1.68	1.57
160.00	1.47	1.37	1.28	1.20	1.12

Type... Pond Routed HYG (total out)
Name... CHERRYWOOD OUT Tag: C 100Y
File... C:\MY DOCUMENTS\CHERRYWOOD.PPW
Storm... C 100YR Tag: C 100Y

Page 1.09
Event: C 100YR

HYDROGRAPH ORDINATES (cfs)
Output Time increment = 1.00 min
Time on left represents time for first value in each row.

Time min					
165.00	1.05	.98	.92	.86	.81
170.00	.74	.68	.62	.56	.51
175.00	.47	.43	.39	.36	.32
180.00	.30	.27	.25	.22	.20
185.00	.19	.17	.14	.12	.10
190.00	.08	.07	.06	.05	.04
195.00	.03	.03	.02	.02	.02
200.00	.01	.01	.01	.01	.01
205.00	.00	.00	.00	.00	.00

POND7

Reanalysis of The Villages at Hutchings Farm Basin
15, 25 and 100 Year 20 Minute Design Storms

Table of Contents

***** RUNOFF HYDROGRAPHS *****

20 INFLOWS.....	A 15YR	
	Read HYG	1.01
20 INFLOWS.....	B 25YR	
	Read HYG	1.03
20 INFLOWS.....	C 100Y	
	Read HYG	1.05

***** POND VOLUMES *****

HUTCH LAKE.....	Vol: Planimeter	2.01
-----------------	-----------------------	------

***** OUTLET STRUCTURES *****

LAKE OUTFALL....	Outlet Input Data	3.01
	Composite Rating Curve	3.03

***** POND ROUTING *****

HUTCH LAKE	OUT A 15YR	
	Pond Routing Summary	4.01
	Pond Routed HYG (total out)	4.02
HUTCH LAKE	OUT B 25YR	
	Pond Routing Summary	4.08
	Pond Routed HYG (total out)	4.09
HUTCH LAKE	OUT C 100Y	
	Pond Routing Summary	4.15
	Pond Routed HYG (total out)	4.16

Type.... Read HYG
 Name.... 20 INFLOWS Tag: A 15YR
 File.... C:\HAESTAD\PPKW\SAMPLE\HUTCH.PPW
 Storm... Tag: A 15YR

Page 1.01
 Event: A 15YR

HYG file = C:\HAESTAD\PPKW\SAMPLE\HUTCH15.HYG
 HYG ID = 15 Year Inflow
 HYG Tag = 15YR

 Peak Discharge = 127.62 cfs
 Time to Peak = 20.00 min
 HYG Volume = 153141 cu.ft

HYDROGRAPH ORDINATES (cfs)

Output Time increment = 2.00 min

Time on left represents time for first value in each row.

Time min					
.00	.00	12.76	25.52	38.29	51.05
10.00	63.81	76.57	89.33	102.09	114.86
20.00	127.62	114.86	102.09	89.33	76.57
30.00	63.81	51.05	38.29	25.52	12.76
40.00	.00	.00	.00	.00	.00
50.00	.00	.00	.00	.00	.00
60.00	.00	.00	.00	.00	.00
70.00	.00	.00	.00	.00	.00
80.00	.00	.00	.00	.00	.00
90.00	.00	.00	.00	.00	.00
100.00	.00	.00	.00	.00	.00
110.00	.00	.00	.00	.00	.00
120.00	.00	.00	.00	.00	.00
130.00	.00	.00	.00	.00	.00
140.00	.00	.00	.00	.00	.00
150.00	.00	.00	.00	.00	.00
160.00	.00	.00	.00	.00	.00
170.00	.00	.00	.00	.00	.00
180.00	.00	.00	.00	.00	.00
190.00	.00	.00	.00	.00	.00
200.00	.00	.00	.00	.00	.00
210.00	.00	.00	.00	.00	.00
220.00	.00	.00	.00	.00	.00
230.00	.00	.00	.00	.00	.00
240.00	.00	.00	.00	.00	.00
250.00	.00	.00	.00	.00	.00
260.00	.00	.00	.00	.00	.00
270.00	.00	.00	.00	.00	.00
280.00	.00	.00	.00	.00	.00
290.00	.00	.00	.00	.00	.00
300.00	.00	.00	.00	.00	.00
310.00	.00	.00	.00	.00	.00
320.00	.00	.00	.00	.00	.00

Type.... Read HYG
 Name.... 20 INFLOWS Tag: A 15YR
 File.... C:\HAESTAD\PPKW\SAMPLE\HUTCH.PPW
 Storm... Tag: A 15YR

Page 1.02
 Event: A 15YR

HYDROGRAPH ORDINATES (cfs)
 Output Time increment = 2.00 min
 Time on left represents time for first value in each row.

Time min					
330.00	.00	.00	.00	.00	.00
340.00	.00	.00	.00	.00	.00
350.00	.00	.00	.00	.00	.00
360.00	.00	.00	.00	.00	.00
370.00	.00	.00	.00	.00	.00
380.00	.00	.00	.00	.00	.00
390.00	.00	.00	.00	.00	.00
400.00	.00	.00	.00	.00	.00
410.00	.00	.00	.00	.00	.00
420.00	.00	.00	.00	.00	.00
430.00	.00	.00	.00	.00	.00
440.00	.00	.00	.00	.00	.00
450.00	.00	.00	.00	.00	.00
460.00	.00	.00	.00	.00	.00
470.00	.00	.00	.00	.00	.00
480.00	.00	.00	.00	.00	.00
490.00	.00	.00	.00	.00	.00
500.00	.00	.00	.00	.00	.00
510.00	.00	.00	.00	.00	.00
520.00	.00	.00	.00	.00	.00
530.00	.00	.00	.00	.00	.00
540.00	.00	.00	.00	.00	.00
550.00	.00	.00	.00	.00	.00
560.00	.00	.00	.00	.00	.00
570.00	.00	.00	.00	.00	.00
580.00	.00	.00	.00	.00	.00
590.00	.00	.00	.00	.00	.00
600.00	.00				

Type.... Read HYG
 Name.... 20 INFLOWS
 File.... C:\HAESTAD\PPKW\SAMPLE\HUTCH.PPW
 Storm... Tag: B 25YR

HYG file = C:\HAESTAD\PPKW\SAMPLE\HUTCH25.HYG
 HYG ID = 25 Year Inflow
 HYG Tag = 25 YR

 Peak Discharge = 157.58 cfs
 Time to Peak = 20.00 min
 HYG Volume = 189093 cu.ft

HYDROGRAPH ORDINATES (cfs)

Output Time increment = 2.00 min

Time on left represents time for first value in each row.

Time min					
.00	.00	15.76	31.52	47.27	63.03
10.00	78.79	94.55	110.30	126.06	141.82
20.00	157.58	141.82	126.06	110.30	94.55
30.00	78.79	63.03	47.27	31.52	15.76
40.00	.00	.00	.00	.00	.00
50.00	.00	.00	.00	.00	.00
60.00	.00	.00	.00	.00	.00
70.00	.00	.00	.00	.00	.00
80.00	.00	.00	.00	.00	.00
90.00	.00	.00	.00	.00	.00
100.00	.00	.00	.00	.00	.00
110.00	.00	.00	.00	.00	.00
120.00	.00	.00	.00	.00	.00
130.00	.00	.00	.00	.00	.00
140.00	.00	.00	.00	.00	.00
150.00	.00	.00	.00	.00	.00
160.00	.00	.00	.00	.00	.00
170.00	.00	.00	.00	.00	.00
180.00	.00	.00	.00	.00	.00
190.00	.00	.00	.00	.00	.00
200.00	.00	.00	.00	.00	.00
210.00	.00	.00	.00	.00	.00
220.00	.00	.00	.00	.00	.00
230.00	.00	.00	.00	.00	.00
240.00	.00	.00	.00	.00	.00
250.00	.00	.00	.00	.00	.00
260.00	.00	.00	.00	.00	.00
270.00	.00	.00	.00	.00	.00
280.00	.00	.00	.00	.00	.00
290.00	.00	.00	.00	.00	.00
300.00	.00	.00	.00	.00	.00
310.00	.00	.00	.00	.00	.00
320.00	.00	.00	.00	.00	.00

Type.... Read HYG
 Name.... 20 INFLOWS
 File.... C:\HAESTAD\PPKW\SAMPLE\HUTCH.PPW
 Storm... Tag: B 25YR

HYDROGRAPH ORDINATES (cfs)
 Output Time increment = 2.00 min
 Time on left represents time for first value in each row.

Time min					
330.00	.00	.00	.00	.00	.00
340.00	.00	.00	.00	.00	.00
350.00	.00	.00	.00	.00	.00
360.00	.00	.00	.00	.00	.00
370.00	.00	.00	.00	.00	.00
380.00	.00	.00	.00	.00	.00
390.00	.00	.00	.00	.00	.00
400.00	.00	.00	.00	.00	.00
410.00	.00	.00	.00	.00	.00
420.00	.00	.00	.00	.00	.00
430.00	.00	.00	.00	.00	.00
440.00	.00	.00	.00	.00	.00
450.00	.00	.00	.00	.00	.00
460.00	.00	.00	.00	.00	.00
470.00	.00	.00	.00	.00	.00
480.00	.00	.00	.00	.00	.00
490.00	.00	.00	.00	.00	.00
500.00	.00	.00	.00	.00	.00
510.00	.00	.00	.00	.00	.00
520.00	.00	.00	.00	.00	.00
530.00	.00	.00	.00	.00	.00
540.00	.00	.00	.00	.00	.00
550.00	.00	.00	.00	.00	.00
560.00	.00	.00	.00	.00	.00
570.00	.00	.00	.00	.00	.00
580.00	.00	.00	.00	.00	.00
590.00	.00	.00	.00	.00	.00
600.00	.00				

Type.... Read HYG
 Name.... 20 INFLOWS
 File.... C:\HAESTAD\PPKW\SAMPLE\HUTCH.PPW
 Storm... Tag: C 100Y

HYG file = C:\HAESTAD\PPKW\SAMPLE\HUTCH100.HYG
 HYG ID = 100 Year Inflow
 HYG Tag = 100YR

Peak Discharge = 201.58 cfs
 Time to Peak = 20.00 min
 HYG Volume = 241896 cu.ft

HYDROGRAPH ORDINATES (cfs)

Output Time increment = 2.00 min

Time on left represents time for first value in each row.

Time min	0.00	20.16	40.32	60.47	80.63
.00	.00	20.16	40.32	60.47	80.63
10.00	100.79	120.95	141.11	161.26	181.42
20.00	201.58	181.42	161.26	141.11	120.95
30.00	100.79	80.63	60.47	40.32	20.16
40.00	.00	.00	.00	.00	.00
50.00	.00	.00	.00	.00	.00
60.00	.00	.00	.00	.00	.00
70.00	.00	.00	.00	.00	.00
80.00	.00	.00	.00	.00	.00
90.00	.00	.00	.00	.00	.00
100.00	.00	.00	.00	.00	.00
110.00	.00	.00	.00	.00	.00
120.00	.00	.00	.00	.00	.00
130.00	.00	.00	.00	.00	.00
140.00	.00	.00	.00	.00	.00
150.00	.00	.00	.00	.00	.00
160.00	.00	.00	.00	.00	.00
170.00	.00	.00	.00	.00	.00
180.00	.00	.00	.00	.00	.00
190.00	.00	.00	.00	.00	.00
200.00	.00	.00	.00	.00	.00
210.00	.00	.00	.00	.00	.00
220.00	.00	.00	.00	.00	.00
230.00	.00	.00	.00	.00	.00
240.00	.00	.00	.00	.00	.00
250.00	.00	.00	.00	.00	.00
260.00	.00	.00	.00	.00	.00
270.00	.00	.00	.00	.00	.00
280.00	.00	.00	.00	.00	.00
290.00	.00	.00	.00	.00	.00
300.00	.00	.00	.00	.00	.00
310.00	.00	.00	.00	.00	.00
320.00	.00	.00	.00	.00	.00

Type.... Read HYG
 Name.... 20 INFLOWS
 File.... C:\HAESTAD\PPKW\SAMPLE\HUTCH.PPW
 Storm... Tag: C 100Y

Page 1.06
 Event: C 100YR

HYDROGRAPH ORDINATES (cfs)
 Output Time increment = 2.00 min
 Time on left represents time for first value in each row.

Time min					
330.00	.00	.00	.00	.00	.00
340.00	.00	.00	.00	.00	.00
350.00	.00	.00	.00	.00	.00
360.00	.00	.00	.00	.00	.00
370.00	.00	.00	.00	.00	.00
380.00	.00	.00	.00	.00	.00
390.00	.00	.00	.00	.00	.00
400.00	.00	.00	.00	.00	.00
410.00	.00	.00	.00	.00	.00
420.00	.00	.00	.00	.00	.00
430.00	.00	.00	.00	.00	.00
440.00	.00	.00	.00	.00	.00
450.00	.00	.00	.00	.00	.00
460.00	.00	.00	.00	.00	.00
470.00	.00	.00	.00	.00	.00
480.00	.00	.00	.00	.00	.00
490.00	.00	.00	.00	.00	.00
500.00	.00	.00	.00	.00	.00
510.00	.00	.00	.00	.00	.00
520.00	.00	.00	.00	.00	.00
530.00	.00	.00	.00	.00	.00
540.00	.00	.00	.00	.00	.00
550.00	.00	.00	.00	.00	.00
560.00	.00	.00	.00	.00	.00
570.00	.00	.00	.00	.00	.00
580.00	.00	.00	.00	.00	.00
590.00	.00	.00	.00	.00	.00
600.00	.00				

Type.... Vol: Planimeter
Name.... HUTCH LAKE

Page 2.01

File.... C:\HAESTAD\PPKW\SAMPLE\HUTCH.PPW

POND VOLUME CALCULATIONS

Planimeter scale: 1.00 ft/in

Elevation (ft)	Planimeter (sq.in)	Area (acres)	A1+A2+sqr(A1*A2) (acres)	Volume (cu.ft)	Volume Sum (cu.ft)
554.00	39466.000	.9060	.0000	0	0
556.00	46295.000	1.0628	2.9501	85670	85670
558.00	53388.000	1.2256	3.4297	99599	185269
560.00	60864.000	1.3972	3.9315	114170	299439
561.00	65461.000	1.5028	4.3491	63149	362588

POND VOLUME EQUATIONS

* Incremental volume computed by the Conic Method for Reservoir Volumes.

$$\text{Volume} = (1/3) * (\text{EL2}-\text{EL1}) * (\text{Area1} + \text{Area2} + \text{sq.rt.}(\text{Area1}*\text{Area2}))$$

where: EL1, EL2 = Lower and upper elevations of the increment
Area1,Area2 = Areas computed for EL1, EL2, respectively
Volume = Incremental volume between EL1 and EL2

S/N: f21101d06a84 Bax Engineering

PondPack Ver: 7.0 (325)

Compute Time: 12:56:31

Date: 08-14-2002

Type.... Outlet Input Data
Name.... LAKE OUTFALL

File.... C:\HAESTAD\PPKW\SAMPLE\HUTCH.PPW
Title... Hutch Outfall Structure

REQUESTED POND WS ELEVATIONS:

Min. Elev.= 554.00 ft
Increment = .10 ft
Max. Elev.= 560.00 ft

OUTLET CONNECTIVITY

---> Forward Flow Only (UpStream to DnStream)
<--- Reverse Flow Only (DnStream to UpStream)
<---> Forward and Reverse Both Allowed

Structure	No.		Outfall	E1, ft	E2, ft
Stand Pipe	GI	--->	TW	558.000	560.000
Orifice-Area	SL	--->	TW	554.000	560.000
TW SETUP, DS Channel					

Type.... Outlet Input Data
Name.... LAKE OUTFALL

File.... C:\HAESTAD\PPKW\SAMPLE\HUTCH.PPW
Title... Hutch Outfall Structure

OUTLET STRUCTURE INPUT DATA

Structure ID = GI
Structure Type = Stand Pipe

of Openings = 1
Invert Elev. = 558.00 ft
Diameter = 5.5000 ft
Orifice Area = 23.7583 sq.ft
Orifice Coeff. = 3.000
Weir Length = 17.28 ft
Weir Coeff. = .600
K, Submerged = .000
K, Reverse = 1.000
Kb, Barrel = .000000 (per ft of full flow)
Barrel Length = .00 ft
Mannings n = .0000

Structure ID = SL
Structure Type = Orifice-Area

of Openings = 1
Invert Elev. = 554.00 ft
Area = 2.0000 sq.ft
Top of Orifice = 556.00 ft
Datum Elev. = 555.00 ft
Orifice Coeff. = .600

Structure ID = TW
Structure Type = TW SETUP, DS Channel

FREE OUTFALL CONDITIONS SPECIFIED

CONVERGENCE TOLERANCES...
Maximum Iterations= 30
Min. TW tolerance = .01 ft
Max. TW tolerance = .01 ft
Min. HW tolerance = .01 ft
Max. HW tolerance = .01 ft
Min. Q tolerance = .10 cfs
Max. Q tolerance = .10 cfs

Type.... Composite Rating Curve
Name.... LAKE OUTFALL

File.... C:\HAESTAD\PPKW\SAMPLE\HUTCH.PPW
Title... Hutch Outfall Structure

***** COMPOSITE OUTFLOW SUMMARY *****

WS Elev, Total Q		Converge		Notes
Elev. ft	Q cfs	TW Elev ft	Error +/-ft	Contributing Structures
554.00	.00	Free	Outfall	SL
554.10	.48	Free	Outfall	SL
554.20	.96	Free	Outfall	SL
554.30	1.44	Free	Outfall	SL
554.40	1.93	Free	Outfall	SL
554.50	2.41	Free	Outfall	SL
554.60	2.89	Free	Outfall	SL
554.70	3.37	Free	Outfall	SL
554.80	3.85	Free	Outfall	SL
554.90	4.33	Free	Outfall	SL
555.00	4.81	Free	Outfall	SL
555.10	5.29	Free	Outfall	SL
555.20	5.78	Free	Outfall	SL
555.30	6.26	Free	Outfall	SL
555.40	6.74	Free	Outfall	SL
555.50	7.22	Free	Outfall	SL
555.60	7.70	Free	Outfall	SL
555.70	8.18	Free	Outfall	SL
555.80	8.66	Free	Outfall	SL
555.90	9.14	Free	Outfall	SL
556.00	9.63	Free	Outfall	SL
556.10	10.10	Free	Outfall	SL
556.20	10.54	Free	Outfall	SL
556.30	10.98	Free	Outfall	SL
556.40	11.39	Free	Outfall	SL
556.50	11.79	Free	Outfall	SL
556.60	12.18	Free	Outfall	SL
556.70	12.55	Free	Outfall	SL
556.80	12.91	Free	Outfall	SL
556.90	13.27	Free	Outfall	SL
557.00	13.61	Free	Outfall	SL
557.10	13.95	Free	Outfall	SL
557.20	14.28	Free	Outfall	SL
557.30	14.60	Free	Outfall	SL
557.40	14.91	Free	Outfall	SL
557.50	15.22	Free	Outfall	SL
557.60	15.52	Free	Outfall	SL
557.70	15.82	Free	Outfall	SL
557.80	16.11	Free	Outfall	SL

Type... Composite Rating Curve
Name... LAKE OUTFALL

File... C:\HAESTAD\PPKW\SAMPLE\HUTCH.PPW
Title... Hutch Outfall Structure

***** COMPOSITE OUTFLOW SUMMARY *****

WS Elev, Total Q		Converge		Notes
Elev. ft	Q cfs	TW Elev ft	Error +/-ft	Contributing Structures
557.90	16.39	Free Outfall		SL
558.00	16.67	Free Outfall		GI +SL
558.10	17.28	Free Outfall		GI +SL
558.20	18.15	Free Outfall		GI +SL
558.30	19.19	Free Outfall		GI +SL
558.40	20.37	Free Outfall		GI +SL
558.50	21.67	Free Outfall		GI +SL
558.60	23.08	Free Outfall		GI +SL
558.70	24.59	Free Outfall		GI +SL
558.80	26.18	Free Outfall		GI +SL
558.90	27.86	Free Outfall		GI +SL
559.00	29.62	Free Outfall		GI +SL
559.10	31.45	Free Outfall		GI +SL
559.20	33.36	Free Outfall		GI +SL
559.30	35.33	Free Outfall		GI +SL
559.40	37.37	Free Outfall		GI +SL
559.50	39.47	Free Outfall		GI +SL
559.60	41.63	Free Outfall		GI +SL
559.70	43.85	Free Outfall		GI +SL
559.80	46.13	Free Outfall		GI +SL
559.90	48.46	Free Outfall		GI +SL
560.00	50.85	Free Outfall		GI +SL

Type.... Pond Routing Summary
Name.... HUTCH LAKE OUT Tag: A 15YR
File.... C:\HAESTAD\PPKW\SAMPLE\HUTCH.PPW
Storm... A 15YR Tag: A 15YR

Page 4.01
Event: A 15YR

LEVEL POOL ROUTING SUMMARY

HYG Dir = C:\HAESTAD\PPKW\SAMPLE\
Inflow HYG file = NONE STORED - HUTCH LAKE IN A 15YR
Outflow HYG file = NONE STORED - HUTCH LAKE OUT A 15YR

Pond Node Data = HUTCH LAKE
Pond Volume Data = HUTCH LAKE
Pond Outlet Data = LAKE OUTFALL

No Infiltration

INITIAL CONDITIONS

Starting WS Elev = 554.00 ft
Starting Volume = 0 cu.ft
Starting Outflow = .00 cfs
Starting Infiltr. = .00 cfs
Starting Total Qout = .00 cfs
Time Increment = 1.00 min

INFLOW/OUTFLOW HYDROGRAPH SUMMARY

=====
Peak Inflow = 127.62 cfs at 20.00 min
Peak Outflow = 13.75 cfs at 38.00 min

Peak Elevation = 557.04 ft
Peak Storage = 135796 cu.ft
=====

MASS BALANCE (cu.ft)

+ Initial Vol = 0
+ HYG Vol IN = 153142
- Infiltration = 0
- HYG Vol OUT = 153117
- Retained Vol = 24

Unrouted Vol = - cu.ft (.000% of Inflow Volume)

Type... Pond Routed HYG (total out)
 Name... HUTCH LAKE OUT Tag: A 15YR
 File... C:\HAESTAD\PPKW\SAMPLE\HUTCH.PPW
 Storm... A 15YR Tag: A 15YR

Page 4.02
 Event: A 15YR

POND ROUTED TOTAL OUTFLOW HYG...

HYG file =
 HYG ID = HUTCH LAKE OUT
 HYG Tag = A 15YR

 Peak Discharge = 13.75 cfs
 Time to Peak = 38.00 min
 HYG Volume = 153117 cu.ft

HYDROGRAPH ORDINATES (cfs)

Output Time increment = 1.00 min
 Time on left represents time for first value in each row.

Time min	.00	.02	.09	.21	.37
5.00	.57	.82	1.11	1.45	1.82
10.00	2.24	2.69	3.18	3.71	4.27
15.00	4.86	5.49	6.15	6.84	7.56
20.00	8.31	9.04	9.72	10.32	10.85
25.00	11.32	11.73	12.09	12.40	12.68
30.00	12.92	13.13	13.30	13.45	13.56
35.00	13.65	13.71	13.75	13.75	13.74
40.00	13.70	13.64	13.58	13.53	13.47
45.00	13.42	13.36	13.30	13.25	13.19
50.00	13.13	13.08	13.02	12.97	12.91
55.00	12.85	12.79	12.74	12.68	12.62
60.00	12.57	12.51	12.45	12.40	12.34
65.00	12.28	12.22	12.17	12.11	12.05
70.00	11.99	11.94	11.88	11.82	11.76
75.00	11.70	11.65	11.59	11.53	11.47
80.00	11.42	11.36	11.30	11.24	11.18
85.00	11.12	11.06	11.01	10.95	10.89
90.00	10.83	10.77	10.71	10.65	10.59
95.00	10.53	10.47	10.41	10.35	10.29
100.00	10.24	10.18	10.12	10.06	10.00
105.00	9.94	9.88	9.82	9.76	9.70
110.00	9.64	9.58	9.52	9.46	9.40
115.00	9.34	9.29	9.23	9.17	9.11
120.00	9.05	9.00	8.94	8.89	8.83
125.00	8.77	8.72	8.66	8.61	8.55
130.00	8.50	8.45	8.39	8.34	8.29
135.00	8.23	8.18	8.13	8.08	8.03
140.00	7.97	7.92	7.87	7.82	7.77
145.00	7.72	7.67	7.62	7.58	7.53
150.00	7.48	7.43	7.38	7.33	7.29
155.00	7.24	7.19	7.15	7.10	7.05
160.00	7.01	6.96	6.92	6.87	6.83

Type.... Pond Routed HYG (total out)
 Name.... HUTCH LAKE OUT Tag: A 15YR
 File.... C:\HAESTAD\PPKW\SAMPLE\HUTCH.PPW
 Storm... A 15YR Tag: A 15YR

Page 4.03
 Event: A 15YR

HYDROGRAPH ORDINATES (cfs)
 Output Time increment = 1.00 min
 Time on left represents time for first value in each row.

Time min					
165.00	6.78	6.74	6.70	6.65	6.61
170.00	6.57	6.52	6.48	6.44	6.40
175.00	6.35	6.31	6.27	6.23	6.19
180.00	6.15	6.11	6.07	6.03	5.99
185.00	5.95	5.91	5.87	5.83	5.79
190.00	5.75	5.72	5.68	5.64	5.60
195.00	5.57	5.53	5.49	5.46	5.42
200.00	5.38	5.35	5.31	5.28	5.24
205.00	5.21	5.17	5.14	5.10	5.07
210.00	5.03	5.00	4.97	4.93	4.90
215.00	4.87	4.84	4.80	4.77	4.74
220.00	4.71	4.67	4.64	4.61	4.58
225.00	4.55	4.52	4.49	4.46	4.43
230.00	4.40	4.37	4.34	4.31	4.28
235.00	4.25	4.22	4.19	4.16	4.14
240.00	4.11	4.08	4.05	4.02	4.00
245.00	3.97	3.94	3.92	3.89	3.86
250.00	3.84	3.81	3.78	3.76	3.73
255.00	3.71	3.68	3.66	3.63	3.61
260.00	3.58	3.56	3.53	3.51	3.48
265.00	3.46	3.44	3.41	3.39	3.37
270.00	3.34	3.32	3.30	3.27	3.25
275.00	3.23	3.21	3.18	3.16	3.14
280.00	3.12	3.10	3.08	3.06	3.03
285.00	3.01	2.99	2.97	2.95	2.93
290.00	2.91	2.89	2.87	2.85	2.83
295.00	2.81	2.79	2.77	2.75	2.73
300.00	2.71	2.69	2.68	2.66	2.64
305.00	2.62	2.60	2.58	2.57	2.55
310.00	2.53	2.51	2.50	2.48	2.46
315.00	2.44	2.43	2.41	2.39	2.38
320.00	2.36	2.34	2.33	2.31	2.29
325.00	2.28	2.26	2.25	2.23	2.21
330.00	2.20	2.18	2.17	2.15	2.14
335.00	2.12	2.11	2.09	2.08	2.06
340.00	2.05	2.03	2.02	2.01	1.99
345.00	1.98	1.96	1.95	1.94	1.92
350.00	1.91	1.90	1.88	1.87	1.86
355.00	1.84	1.83	1.82	1.80	1.79
360.00	1.78	1.77	1.75	1.74	1.73
365.00	1.72	1.70	1.69	1.68	1.67
370.00	1.66	1.64	1.63	1.62	1.61
375.00	1.60	1.59	1.58	1.56	1.55
380.00	1.54	1.53	1.52	1.51	1.50
385.00	1.49	1.48	1.47	1.46	1.45
390.00	1.44	1.43	1.42	1.41	1.40
395.00	1.39	1.38	1.37	1.36	1.35

Type.... Pond Routed HYG (total out)
 Name.... HUTCH LAKE OUT Tag: A 15YR
 File.... C:\HAESTAD\PPKW\SAMPLE\HUTCH.PPW
 Storm... A 15YR Tag: A 15YR

Page 4.04
 Event: A 15YR

HYDROGRAPH ORDINATES (cfs)
 Output Time increment = 1.00 min
 Time on left represents time for first value in each row.

Time min					
400.00	1.34	1.33	1.32	1.31	1.30
405.00	1.29	1.28	1.27	1.26	1.25
410.00	1.24	1.24	1.23	1.22	1.21
415.00	1.20	1.19	1.18	1.18	1.17
420.00	1.16	1.15	1.14	1.13	1.13
425.00	1.12	1.11	1.10	1.09	1.09
430.00	1.08	1.07	1.06	1.06	1.05
435.00	1.04	1.03	1.03	1.02	1.01
440.00	1.00	1.00	.99	.98	.98
445.00	.97	.96	.95	.95	.94
450.00	.93	.93	.92	.91	.91
455.00	.90	.89	.89	.88	.88
460.00	.87	.86	.86	.85	.84
465.00	.84	.83	.83	.82	.81
470.00	.81	.80	.80	.79	.79
475.00	.78	.77	.77	.76	.76
480.00	.75	.75	.74	.74	.73
485.00	.73	.72	.72	.71	.70
490.00	.70	.69	.69	.68	.68
495.00	.67	.67	.67	.66	.66
500.00	.65	.65	.64	.64	.63
505.00	.63	.62	.62	.61	.61
510.00	.61	.60	.60	.59	.59
515.00	.58	.58	.58	.57	.57
520.00	.56	.56	.56	.55	.55
525.00	.54	.54	.54	.53	.53
530.00	.52	.52	.52	.51	.51
535.00	.51	.50	.50	.49	.49
540.00	.49	.48	.48	.48	.47
545.00	.47	.47	.46	.46	.46
550.00	.45	.45	.45	.44	.44
555.00	.44	.43	.43	.43	.42
560.00	.42	.42	.42	.41	.41
565.00	.41	.40	.40	.40	.39
570.00	.39	.39	.39	.38	.38
575.00	.38	.38	.37	.37	.37
580.00	.36	.36	.36	.36	.35
585.00	.35	.35	.35	.34	.34
590.00	.34	.34	.33	.33	.33
595.00	.33	.32	.32	.32	.32
600.00	.31	.31	.31	.31	.31
605.00	.30	.30	.30	.30	.29
610.00	.29	.29	.29	.29	.28
615.00	.28	.28	.28	.28	.27
620.00	.27	.27	.27	.27	.26
625.00	.26	.26	.26	.26	.25
630.00	.25	.25	.25	.25	.25

S/N: f21101d06a84 Bax Engineering
 PondPack Ver: 7.0 (325) Compute Time: 12:56:31 Date: 08-14-2002

Type.... Pond Routed HYG (total out)
 Name.... HUTCH LAKE OUT Tag: A 15YR
 File.... C:\HAESTAD\PPKW\SAMPLE\HUTCH.PPW
 Storm... A 15YR Tag: A 15YR

HYDROGRAPH ORDINATES (cfs)
 Output Time increment = 1.00 min
 Time on left represents time for first value in each row.

Time min					
635.00	.24	.24	.24	.24	.24
640.00	.24	.23	.23	.23	.23
645.00	.23	.23	.22	.22	.22
650.00	.22	.22	.22	.21	.21
655.00	.21	.21	.21	.21	.20
660.00	.20	.20	.20	.20	.20
665.00	.20	.19	.19	.19	.19
670.00	.19	.19	.19	.18	.18
675.00	.18	.18	.18	.18	.18
680.00	.18	.17	.17	.17	.17
685.00	.17	.17	.17	.17	.16
690.00	.16	.16	.16	.16	.16
695.00	.16	.16	.16	.15	.15
700.00	.15	.15	.15	.15	.15
705.00	.15	.15	.14	.14	.14
710.00	.14	.14	.14	.14	.14
715.00	.14	.14	.13	.13	.13
720.00	.13	.13	.13	.13	.13
725.00	.13	.13	.12	.12	.12
730.00	.12	.12	.12	.12	.12
735.00	.12	.12	.12	.12	.11
740.00	.11	.11	.11	.11	.11
745.00	.11	.11	.11	.11	.11
750.00	.11	.10	.10	.10	.10
755.00	.10	.10	.10	.10	.10
760.00	.10	.10	.10	.10	.10
765.00	.09	.09	.09	.09	.09
770.00	.09	.09	.09	.09	.09
775.00	.09	.09	.09	.09	.09
780.00	.08	.08	.08	.08	.08
785.00	.08	.08	.08	.08	.08
790.00	.08	.08	.08	.08	.08
795.00	.08	.08	.07	.07	.07
800.00	.07	.07	.07	.07	.07
805.00	.07	.07	.07	.07	.07
810.00	.07	.07	.07	.07	.07
815.00	.07	.07	.06	.06	.06
820.00	.06	.06	.06	.06	.06
825.00	.06	.06	.06	.06	.06
830.00	.06	.06	.06	.06	.06
835.00	.06	.06	.06	.06	.06
840.00	.05	.05	.05	.05	.05
845.00	.05	.05	.05	.05	.05
850.00	.05	.05	.05	.05	.05
855.00	.05	.05	.05	.05	.05
860.00	.05	.05	.05	.05	.05
865.00	.05	.05	.04	.04	.04

Type... Pond Routed HYG (total out)
 Name... HUTCH LAKE OUT Tag: A 15YR
 File... C:\HAESTAD\PPKW\SAMPLE\HUTCH.PPW
 Storm... A 15YR Tag: A 15YR

Page 4.06
 Event: A 15YR

HYDROGRAPH ORDINATES (cfs)
 Output Time increment = 1.00 min
 Time on left represents time for first value in each row.

Time min					
870.00	.04	.04	.04	.04	.04
875.00	.04	.04	.04	.04	.04
880.00	.04	.04	.04	.04	.04
885.00	.04	.04	.04	.04	.04
890.00	.04	.04	.04	.04	.04
895.00	.04	.04	.04	.04	.04
900.00	.04	.04	.03	.03	.03
905.00	.03	.03	.03	.03	.03
910.00	.03	.03	.03	.03	.03
915.00	.03	.03	.03	.03	.03
920.00	.03	.03	.03	.03	.03
925.00	.03	.03	.03	.03	.03
930.00	.03	.03	.03	.03	.03
935.00	.03	.03	.03	.03	.03
940.00	.03	.03	.03	.03	.03
945.00	.03	.03	.03	.02	.02
950.00	.02	.02	.02	.02	.02
955.00	.02	.02	.02	.02	.02
960.00	.02	.02	.02	.02	.02
965.00	.02	.02	.02	.02	.02
970.00	.02	.02	.02	.02	.02
975.00	.02	.02	.02	.02	.02
980.00	.02	.02	.02	.02	.02
985.00	.02	.02	.02	.02	.02
990.00	.02	.02	.02	.02	.02
995.00	.02	.02	.02	.02	.02
1000.00	.02	.02	.02	.02	.02
1005.00	.02	.02	.02	.02	.02
1010.00	.02	.02	.02	.02	.02
1015.00	.02	.02	.02	.01	.01
1020.00	.01	.01	.01	.01	.01
1025.00	.01	.01	.01	.01	.01
1030.00	.01	.01	.01	.01	.01
1035.00	.01	.01	.01	.01	.01
1040.00	.01	.01	.01	.01	.01
1045.00	.01	.01	.01	.01	.01
1050.00	.01	.01	.01	.01	.01
1055.00	.01	.01	.01	.01	.01
1060.00	.01	.01	.01	.01	.01
1065.00	.01	.01	.01	.01	.01
1070.00	.01	.01	.01	.01	.01
1075.00	.01	.01	.01	.01	.01
1080.00	.01	.01	.01	.01	.01
1085.00	.01	.01	.01	.01	.01
1090.00	.01	.01	.01	.01	.01
1095.00	.01	.01	.01	.01	.01
1100.00	.01	.01	.01	.01	.01

Type.... Pond Routed HYG (total out)
 Name.... HUTCH LAKE OUT Tag: A 15YR
 File.... C:\HAESTAD\PPKW\SAMPLE\HUTCH.PPW
 Storm... A 15YR Tag: A 15YR

Page 4.07
 Event: A 15YR

HYDROGRAPH ORDINATES (cfs)
 Output Time increment = 1.00 min
 Time on left represents time for first value in each row.

Time min					
1105.00	.01	.01	.01	.01	.01
1110.00	.01	.01	.01	.01	.01
1115.00	.01	.01	.01	.01	.01
1120.00	.01	.01	.01	.01	.01
1125.00	.01	.01	.01	.01	.01
1130.00	.01	.01	.01	.01	.01
1135.00	.01	.01	.01	.01	.01
1140.00	.01	.01	.01	.01	.01
1145.00	.01	.01	.01	.01	.01
1150.00	.01	.01	.01	.01	.01
1155.00	.01	.01	.01	.01	.01
1160.00	.01	.01	.01	.01	.01
1165.00	.01	.01	.01	.01	.00
1170.00	.00	.00	.00	.00	.00
1175.00	.00	.00	.00	.00	.00
1180.00	.00	.00	.00	.00	.00
1185.00	.00	.00	.00	.00	.00
1190.00	.00	.00	.00	.00	.00
1195.00	.00	.00	.00	.00	.00
1200.00	.00	.00	.00	.00	.00
1205.00	.00	.00	.00	.00	.00
1210.00	.00	.00	.00	.00	.00
1215.00	.00	.00	.00	.00	.00
1220.00	.00	.00	.00	.00	.00
1225.00	.00	.00	.00	.00	.00
1230.00	.00	.00	.00	.00	.00
1235.00	.00	.00	.00	.00	.00

Type.... Pond Routing Summary
Name.... HUTCH LAKE OUT Tag: B 25YR
File.... C:\HAESTAD\PPKW\SAMPLE\HUTCH.PPW
Storm... B 25YR Tag: B 25YR

Page 4.08
Event: B 25YR

LEVEL POOL ROUTING SUMMARY

HYG Dir = C:\HAESTAD\PPKW\SAMPLE\
Inflow HYG file = NONE STORED - HUTCH LAKE IN B 25YR
Outflow HYG file = NONE STORED - HUTCH LAKE OUT B 25YR

Pond Node Data = HUTCH LAKE
Pond Volume Data = HUTCH LAKE
Pond Outlet Data = LAKE OUTFALL

No Infiltration

INITIAL CONDITIONS

Starting WS Elev = 554.00 ft
Starting Volume = 0 cu.ft
Starting Outflow = .00 cfs
Starting Infiltr. = .00 cfs
Starting Total Qout = .00 cfs
Time Increment = 1.00 min

INFLOW/OUTFLOW HYDROGRAPH SUMMARY

=====
Peak Inflow = 157.58 cfs at 20.00 min
Peak Outflow = 15.78 cfs at 38.00 min

Peak Elevation = 557.69 ft
Peak Storage = 168697 cu.ft
=====

MASS BALANCE (cu.ft)

+ Initial Vol = 0
+ HYG Vol IN = 189094
- Infiltration = 0
- HYG Vol OUT = 189069
- Retained Vol = 24

Unrouted Vol = -1 cu.ft (.000% of Inflow Volume)

S/N: f21101d06a84 Bax Engineering
PondPack Ver: 7.0 (325) Compute Time: 12:56:31 Date: 08-14-2002

Type.... Pond Routed HYG (total out)
 Name.... HUTCH LAKE OUT Tag: B 25YR
 File.... C:\HAESTAD\PPKW\SAMPLE\HUTCH.PPW
 Storm... B 25YR Tag: B 25YR

Page 4.09
 Event: B 25YR

POND ROUTED TOTAL OUTFLOW HYG...

HYG file =
 HYG ID = HUTCH LAKE OUT
 HYG Tag = B 25YR

 Peak Discharge = 15.78 cfs
 Time to Peak = 38.00 min
 HYG Volume = 189069 cu.ft

HYDROGRAPH ORDINATES (cfs)

Output Time increment = 1.00 min
 Time on left represents time for first value in each row.

Time min					
.00	.00	.03	.11	.26	.45
5.00	.71	1.01	1.37	1.78	2.24
10.00	2.75	3.30	3.90	4.54	5.23
15.00	5.95	6.71	7.51	8.34	9.21
20.00	10.10	10.90	11.60	12.21	12.75
25.00	13.23	13.65	14.02	14.35	14.63
30.00	14.88	15.10	15.28	15.44	15.56
35.00	15.66	15.72	15.76	15.78	15.76
40.00	15.72	15.67	15.62	15.56	15.51
45.00	15.46	15.40	15.35	15.29	15.24
50.00	15.19	15.13	15.08	15.02	14.97
55.00	14.92	14.86	14.81	14.75	14.70
60.00	14.64	14.59	14.53	14.48	14.42
65.00	14.37	14.32	14.26	14.20	14.15
70.00	14.09	14.04	13.98	13.93	13.87
75.00	13.82	13.76	13.71	13.65	13.60
80.00	13.54	13.48	13.43	13.37	13.31
85.00	13.26	13.20	13.14	13.09	13.03
90.00	12.98	12.92	12.86	12.81	12.75
95.00	12.69	12.64	12.58	12.52	12.46
100.00	12.41	12.35	12.29	12.24	12.18
105.00	12.12	12.06	12.00	11.95	11.89
110.00	11.83	11.77	11.72	11.66	11.60
115.00	11.54	11.48	11.43	11.37	11.31
120.00	11.25	11.19	11.13	11.07	11.02
125.00	10.96	10.90	10.84	10.78	10.72
130.00	10.66	10.60	10.55	10.49	10.43
135.00	10.37	10.31	10.25	10.19	10.13
140.00	10.07	10.01	9.95	9.89	9.83
145.00	9.77	9.71	9.65	9.59	9.53
150.00	9.47	9.41	9.35	9.30	9.24
155.00	9.18	9.12	9.07	9.01	8.95
160.00	8.90	8.84	8.78	8.73	8.67

Type.... Pond Routed HYG (total out)
 Name.... HUTCH LAKE OUT Tag: B 25YR
 File.... C:\HAESTAD\PPKW\SAMPLE\HUTCH.PPW
 Storm... B 25YR Tag: B 25YR

Page 4.10
 Event: B 25YR

HYDROGRAPH ORDINATES (cfs)
 Output Time increment = 1.00 min
 Time on left represents time for first value in each row.

Time min					
165.00	8.62	8.56	8.51	8.46	8.40
170.00	8.35	8.30	8.24	8.19	8.14
175.00	8.09	8.04	7.98	7.93	7.88
180.00	7.83	7.78	7.73	7.68	7.63
185.00	7.58	7.54	7.49	7.44	7.39
190.00	7.34	7.30	7.25	7.20	7.16
195.00	7.11	7.06	7.02	6.97	6.93
200.00	6.88	6.84	6.79	6.75	6.70
205.00	6.66	6.62	6.57	6.53	6.49
210.00	6.45	6.40	6.36	6.32	6.28
215.00	6.24	6.20	6.16	6.11	6.07
220.00	6.03	5.99	5.96	5.92	5.88
225.00	5.84	5.80	5.76	5.72	5.69
230.00	5.65	5.61	5.57	5.54	5.50
235.00	5.46	5.43	5.39	5.35	5.32
240.00	5.28	5.25	5.21	5.18	5.14
245.00	5.11	5.07	5.04	5.01	4.97
250.00	4.94	4.91	4.87	4.84	4.81
255.00	4.78	4.74	4.71	4.68	4.65
260.00	4.62	4.59	4.56	4.52	4.49
265.00	4.46	4.43	4.40	4.37	4.34
270.00	4.31	4.29	4.26	4.23	4.20
275.00	4.17	4.14	4.11	4.09	4.06
280.00	4.03	4.00	3.98	3.95	3.92
285.00	3.89	3.87	3.84	3.82	3.79
290.00	3.76	3.74	3.71	3.69	3.66
295.00	3.64	3.61	3.59	3.56	3.54
300.00	3.51	3.49	3.47	3.44	3.42
305.00	3.39	3.37	3.35	3.32	3.30
310.00	3.28	3.26	3.23	3.21	3.19
315.00	3.17	3.15	3.12	3.10	3.08
320.00	3.06	3.04	3.02	3.00	2.98
325.00	2.95	2.93	2.91	2.89	2.87
330.00	2.85	2.83	2.81	2.79	2.77
335.00	2.76	2.74	2.72	2.70	2.68
340.00	2.66	2.64	2.62	2.61	2.59
345.00	2.57	2.55	2.53	2.52	2.50
350.00	2.48	2.46	2.45	2.43	2.41
355.00	2.40	2.38	2.36	2.35	2.33
360.00	2.31	2.30	2.28	2.26	2.25
365.00	2.23	2.22	2.20	2.19	2.17
370.00	2.16	2.14	2.13	2.11	2.10
375.00	2.08	2.07	2.05	2.04	2.02
380.00	2.01	1.99	1.98	1.97	1.95
385.00	1.94	1.93	1.91	1.90	1.88
390.00	1.87	1.86	1.85	1.83	1.82
395.00	1.81	1.79	1.78	1.77	1.76

Type.... Pond Routed HYG (total out)
 Name.... HUTCH LAKE OUT Tag: B 25YR
 File.... C:\HAESTAD\PPKW\SAMPLE\HUTCH.PPW
 Storm... B 25YR Tag: B 25YR

Page 4.11
 Event: B 25YR

HYDROGRAPH ORDINATES (cfs)
 Output Time increment = 1.00 min
 Time on left represents time for first value in each row.

Time min					
400.00	1.74	1.73	1.72	1.71	1.69
405.00	1.68	1.67	1.66	1.65	1.63
410.00	1.62	1.61	1.60	1.59	1.58
415.00	1.57	1.56	1.54	1.53	1.52
420.00	1.51	1.50	1.49	1.48	1.47
425.00	1.46	1.45	1.44	1.43	1.42
430.00	1.41	1.40	1.39	1.38	1.37
435.00	1.36	1.35	1.34	1.33	1.32
440.00	1.31	1.30	1.29	1.28	1.27
445.00	1.26	1.26	1.25	1.24	1.23
450.00	1.22	1.21	1.20	1.19	1.19
455.00	1.18	1.17	1.16	1.15	1.14
460.00	1.14	1.13	1.12	1.11	1.10
465.00	1.10	1.09	1.08	1.07	1.06
470.00	1.06	1.05	1.04	1.03	1.03
475.00	1.02	1.01	1.01	1.00	.99
480.00	.98	.98	.97	.96	.96
485.00	.95	.94	.94	.93	.92
490.00	.92	.91	.90	.90	.89
495.00	.88	.88	.87	.86	.86
500.00	.85	.85	.84	.83	.83
505.00	.82	.82	.81	.80	.80
510.00	.79	.79	.78	.78	.77
515.00	.76	.76	.75	.75	.74
520.00	.74	.73	.73	.72	.72
525.00	.71	.71	.70	.70	.69
530.00	.69	.68	.68	.67	.67
535.00	.66	.66	.65	.65	.64
540.00	.64	.63	.63	.62	.62
545.00	.62	.61	.61	.60	.60
550.00	.59	.59	.58	.58	.58
555.00	.57	.57	.56	.56	.56
560.00	.55	.55	.54	.54	.54
565.00	.53	.53	.52	.52	.52
570.00	.51	.51	.51	.50	.50
575.00	.50	.49	.49	.48	.48
580.00	.48	.47	.47	.47	.46
585.00	.46	.46	.45	.45	.45
590.00	.44	.44	.44	.43	.43
595.00	.43	.43	.42	.42	.42
600.00	.41	.41	.41	.40	.40
605.00	.40	.40	.39	.39	.39
610.00	.38	.38	.38	.38	.37
615.00	.37	.37	.36	.36	.36
620.00	.36	.35	.35	.35	.35
625.00	.34	.34	.34	.34	.33
630.00	.33	.33	.33	.32	.32

Type.... Pond Routed HYG (total out)
 Name.... HUTCH LAKE OUT Tag: B 25YR
 File.... C:\HAESTAD\PPKW\SAMPLE\HUTCH.PPW
 Storm... B 25YR Tag: B 25YR

Page 4.12
 Event: B 25YR

HYDROGRAPH ORDINATES (cfs)						
Time min	Output Time increment = 1.00 min					
	Time on left represents time for first value in each row.					
635.00	.32	.32	.32	.31	.31	
640.00	.31	.31	.30	.30	.30	
645.00	.30	.30	.29	.29	.29	
650.00	.29	.28	.28	.28	.28	
655.00	.28	.27	.27	.27	.27	
660.00	.27	.26	.26	.26	.26	
665.00	.26	.26	.25	.25	.25	
670.00	.25	.25	.24	.24	.24	
675.00	.24	.24	.24	.23	.23	
680.00	.23	.23	.23	.23	.22	
685.00	.22	.22	.22	.22	.22	
690.00	.21	.21	.21	.21	.21	
695.00	.21	.21	.20	.20	.20	
700.00	.20	.20	.20	.19	.19	
705.00	.19	.19	.19	.19	.19	
710.00	.19	.18	.18	.18	.18	
715.00	.18	.18	.18	.17	.17	
720.00	.17	.17	.17	.17	.17	
725.00	.17	.16	.16	.16	.16	
730.00	.16	.16	.16	.16	.16	
735.00	.15	.15	.15	.15	.15	
740.00	.15	.15	.15	.15	.14	
745.00	.14	.14	.14	.14	.14	
750.00	.14	.14	.14	.14	.13	
755.00	.13	.13	.13	.13	.13	
760.00	.13	.13	.13	.13	.12	
765.00	.12	.12	.12	.12	.12	
770.00	.12	.12	.12	.12	.12	
775.00	.12	.11	.11	.11	.11	
780.00	.11	.11	.11	.11	.11	
785.00	.11	.11	.11	.10	.10	
790.00	.10	.10	.10	.10	.10	
795.00	.10	.10	.10	.10	.10	
800.00	.10	.10	.09	.09	.09	
805.00	.09	.09	.09	.09	.09	
810.00	.09	.09	.09	.09	.09	
815.00	.09	.09	.08	.08	.08	
820.00	.08	.08	.08	.08	.08	
825.00	.08	.08	.08	.08	.08	
830.00	.08	.08	.08	.08	.08	
835.00	.07	.07	.07	.07	.07	
840.00	.07	.07	.07	.07	.07	
845.00	.07	.07	.07	.07	.07	
850.00	.07	.07	.07	.07	.06	
855.00	.06	.06	.06	.06	.06	
860.00	.06	.06	.06	.06	.06	
865.00	.06	.06	.06	.06	.06	

S/N: f21101d06a84 Bax Engineering
 PondPack Ver: 7.0 (325) Compute Time: 12:56:31 Date: 08-14-2002

Type.... Pond Routed HYG (total out)
 Name.... HUTCH LAKE OUT Tag: B 25YR
 File.... C:\HAESTAD\PPKW\SAMPLE\HUTCH.PPW
 Storm... B 25YR Tag: B 25YR

HYDROGRAPH ORDINATES (cfs)
 Output Time increment = 1.00 min
 Time on left represents time for first value in each row.

Time min					
870.00	.06	.06	.06	.06	.06
875.00	.06	.06	.05	.05	.05
880.00	.05	.05	.05	.05	.05
885.00	.05	.05	.05	.05	.05
890.00	.05	.05	.05	.05	.05
895.00	.05	.05	.05	.05	.05
900.00	.05	.05	.05	.05	.05
905.00	.04	.04	.04	.04	.04
910.00	.04	.04	.04	.04	.04
915.00	.04	.04	.04	.04	.04
920.00	.04	.04	.04	.04	.04
925.00	.04	.04	.04	.04	.04
930.00	.04	.04	.04	.04	.04
935.00	.04	.04	.04	.04	.03
940.00	.03	.03	.03	.03	.03
945.00	.03	.03	.03	.03	.03
950.00	.03	.03	.03	.03	.03
955.00	.03	.03	.03	.03	.03
960.00	.03	.03	.03	.03	.03
965.00	.03	.03	.03	.03	.03
970.00	.03	.03	.03	.03	.03
975.00	.03	.03	.03	.03	.03
980.00	.03	.03	.03	.03	.03
985.00	.02	.02	.02	.02	.02
990.00	.02	.02	.02	.02	.02
995.00	.02	.02	.02	.02	.02
1000.00	.02	.02	.02	.02	.02
1005.00	.02	.02	.02	.02	.02
1010.00	.02	.02	.02	.02	.02
1015.00	.02	.02	.02	.02	.02
1020.00	.02	.02	.02	.02	.02
1025.00	.02	.02	.02	.02	.02
1030.00	.02	.02	.02	.02	.02
1035.00	.02	.02	.02	.02	.02
1040.00	.02	.02	.02	.02	.02
1045.00	.02	.02	.02	.02	.02
1050.00	.02	.02	.02	.02	.02
1055.00	.01	.01	.01	.01	.01
1060.00	.01	.01	.01	.01	.01
1065.00	.01	.01	.01	.01	.01
1070.00	.01	.01	.01	.01	.01
1075.00	.01	.01	.01	.01	.01
1080.00	.01	.01	.01	.01	.01
1085.00	.01	.01	.01	.01	.01
1090.00	.01	.01	.01	.01	.01
1095.00	.01	.01	.01	.01	.01
1100.00	.01	.01	.01	.01	.01

Type... Pond Routed HYG (total out)
 Name... HUTCH LAKE OUT Tag: B 25YR
 File... C:\HAESTAD\PPKW\SAMPLE\HUTCH.PPW
 Storm... B 25YR Tag: B 25YR

Page 4.14
 Event: B 25YR

HYDROGRAPH ORDINATES (cfs)
 Output Time increment = 1.00 min
 Time on left represents time for first value in each row.

Time min					
1105.00	.01	.01	.01	.01	.01
1110.00	.01	.01	.01	.01	.01
1115.00	.01	.01	.01	.01	.01
1120.00	.01	.01	.01	.01	.01
1125.00	.01	.01	.01	.01	.01
1130.00	.01	.01	.01	.01	.01
1135.00	.01	.01	.01	.01	.01
1140.00	.01	.01	.01	.01	.01
1145.00	.01	.01	.01	.01	.01
1150.00	.01	.01	.01	.01	.01
1155.00	.01	.01	.01	.01	.01
1160.00	.01	.01	.01	.01	.01
1165.00	.01	.01	.01	.01	.01
1170.00	.01	.01	.01	.01	.01
1175.00	.01	.01	.01	.01	.01
1180.00	.01	.01	.01	.01	.01
1185.00	.01	.01	.01	.01	.01
1190.00	.01	.01	.01	.01	.01
1195.00	.01	.01	.01	.01	.01
1200.00	.01	.01	.01	.01	.01
1205.00	.01	.00	.00	.00	.00
1210.00	.00	.00	.00	.00	.00
1215.00	.00	.00	.00	.00	.00
1220.00	.00	.00	.00	.00	.00
1225.00	.00	.00	.00	.00	.00
1230.00	.00	.00	.00	.00	.00
1235.00	.00	.00	.00	.00	.00
1240.00	.00	.00	.00	.00	.00
1245.00	.00	.00	.00	.00	.00
1250.00	.00	.00	.00	.00	.00
1255.00	.00	.00	.00	.00	.00
1260.00	.00	.00	.00	.00	.00
1265.00	.00	.00	.00	.00	.00
1270.00	.00	.00	.00	.00	.00
1275.00	.00	.00	.00	.00	.00

Type.... Pond Routing Summary
Name.... HUTCH LAKE OUT Tag: C 100Y
File.... C:\HAESTAD\PPKW\SAMPLE\HUTCH.PPW
Storm... C 100YR Tag: C 100Y

Page 4.15
Event: C 100YR

LEVEL POOL ROUTING SUMMARY

HYG Dir = C:\HAESTAD\PPKW\SAMPLE\
Inflow HYG file = NONE STORED - HUTCH LAKE IN C 100Y
Outflow HYG file = NONE STORED - HUTCH LAKE OUT C 100Y

Pond Node Data = HUTCH LAKE
Pond Volume Data = HUTCH LAKE
Pond Outlet Data = LAKE OUTFALL

No Infiltration

INITIAL CONDITIONS

Starting WS Elev = 554.00 ft
Starting Volume = 0 cu.ft
Starting Outflow = .00 cfs
Starting Infiltr. = .00 cfs
Starting Total Qout = .00 cfs
Time Increment = 1.00 min

INFLOW/OUTFLOW HYDROGRAPH SUMMARY

=====
Peak Inflow = 201.58 cfs at 20.00 min
Peak Outflow = 22.58 cfs at 38.00 min

Peak Elevation = 558.56 ft
Peak Storage = 215990 cu.ft
=====

MASS BALANCE (cu.ft)

+ Initial Vol = 0
+ HYG Vol IN = 241896
- Infiltration = 0
- HYG Vol OUT = 241872
- Retained Vol = 24

Unrouted Vol = -1 cu.ft (.000% of Inflow Volume)

Type... Pond Routed HYG (total out)
 Name... HUTCH LAKE OUT Tag: C 100Y
 File... C:\HAESTAD\PPKW\SAMPLE\HUTCH.PPW
 Storm... C 100YR Tag: C 100Y

POND ROUTED TOTAL OUTFLOW HYG...

HYG file =
 HYG ID = HUTCH LAKE OUT
 HYG Tag = C 100Y

 Peak Discharge = 22.58 cfs
 Time to Peak = 38.00 min
 HYG Volume = 241872 cu.ft

HYDROGRAPH ORDINATES (cfs)

Output Time increment = 1.00 min
 Time on left represents time for first value in each row.

Time min	.00	.04	.15	.33	.58
5.00	.90	1.29	1.75	2.27	2.85
10.00	3.49	4.19	4.95	5.75	6.61
15.00	7.51	8.46	9.46	10.45	11.40
20.00	12.30	13.12	13.84	14.47	15.03
25.00	15.53	15.97	16.36	16.74	17.47
30.00	18.36	19.25	20.11	20.86	21.49
35.00	21.99	22.35	22.54	22.58	22.47
40.00	22.21	21.87	21.55	21.25	20.95
45.00	20.65	20.36	20.10	19.84	19.58
50.00	19.33	19.09	18.87	18.66	18.44
55.00	18.23	18.04	17.87	17.70	17.53
60.00	17.36	17.22	17.10	16.99	16.87
65.00	16.76	16.66	16.61	16.55	16.50
70.00	16.45	16.40	16.35	16.29	16.24
75.00	16.19	16.14	16.08	16.03	15.98
80.00	15.92	15.87	15.82	15.76	15.71
85.00	15.66	15.60	15.55	15.50	15.44
90.00	15.39	15.34	15.28	15.23	15.17
95.00	15.12	15.07	15.01	14.96	14.90
100.00	14.85	14.79	14.74	14.69	14.63
105.00	14.58	14.52	14.47	14.41	14.36
110.00	14.30	14.25	14.19	14.14	14.08
115.00	14.03	13.97	13.92	13.86	13.80
120.00	13.75	13.69	13.64	13.58	13.53
125.00	13.47	13.41	13.36	13.30	13.25
130.00	13.19	13.13	13.08	13.02	12.96
135.00	12.91	12.85	12.79	12.74	12.68
140.00	12.62	12.57	12.51	12.45	12.39
145.00	12.34	12.28	12.22	12.16	12.11
150.00	12.05	11.99	11.93	11.88	11.82
155.00	11.76	11.70	11.64	11.59	11.53
160.00	11.47	11.41	11.35	11.29	11.24

Type.... Pond Routed HYG (total out)
 Name.... HUTCH LAKE OUT Tag: C 100Y
 File.... C:\HAESTAD\PPKW\SAMPLE\HUTCH.PPW
 Storm... C 100YR Tag: C 100Y

HYDROGRAPH ORDINATES (cfs)
 Output Time increment = 1.00 min
 Time on left represents time for first value in each row.

Time min					
165.00	11.18	11.12	11.06	11.00	10.94
170.00	10.88	10.82	10.77	10.71	10.65
175.00	10.59	10.53	10.47	10.41	10.35
180.00	10.29	10.23	10.17	10.12	10.06
185.00	9.99	9.93	9.87	9.81	9.76
190.00	9.70	9.64	9.58	9.52	9.46
195.00	9.40	9.34	9.28	9.22	9.17
200.00	9.11	9.05	9.00	8.94	8.88
205.00	8.83	8.77	8.72	8.66	8.61
210.00	8.55	8.50	8.44	8.39	8.34
215.00	8.28	8.23	8.18	8.13	8.08
220.00	8.02	7.97	7.92	7.87	7.82
225.00	7.77	7.72	7.67	7.62	7.57
230.00	7.52	7.48	7.43	7.38	7.33
235.00	7.28	7.24	7.19	7.14	7.10
240.00	7.05	7.01	6.96	6.92	6.87
245.00	6.83	6.78	6.74	6.69	6.65
250.00	6.61	6.56	6.52	6.48	6.44
255.00	6.39	6.35	6.31	6.27	6.23
260.00	6.19	6.15	6.11	6.07	6.03
265.00	5.99	5.95	5.91	5.87	5.83
270.00	5.79	5.75	5.71	5.68	5.64
275.00	5.60	5.56	5.53	5.49	5.45
280.00	5.42	5.38	5.35	5.31	5.27
285.00	5.24	5.20	5.17	5.13	5.10
290.00	5.07	5.03	5.00	4.97	4.93
295.00	4.90	4.87	4.83	4.80	4.77
300.00	4.74	4.70	4.67	4.64	4.61
305.00	4.58	4.55	4.52	4.49	4.46
310.00	4.43	4.40	4.37	4.34	4.31
315.00	4.28	4.25	4.22	4.19	4.16
320.00	4.13	4.11	4.08	4.05	4.02
325.00	4.00	3.97	3.94	3.92	3.89
330.00	3.86	3.84	3.81	3.78	3.76
335.00	3.73	3.71	3.68	3.66	3.63
340.00	3.61	3.58	3.56	3.53	3.51
345.00	3.48	3.46	3.44	3.41	3.39
350.00	3.37	3.34	3.32	3.30	3.27
355.00	3.25	3.23	3.21	3.18	3.16
360.00	3.14	3.12	3.10	3.08	3.05
365.00	3.03	3.01	2.99	2.97	2.95
370.00	2.93	2.91	2.89	2.87	2.85
375.00	2.83	2.81	2.79	2.77	2.75
380.00	2.73	2.71	2.69	2.68	2.66
385.00	2.64	2.62	2.60	2.58	2.57
390.00	2.55	2.53	2.51	2.49	2.48
395.00	2.46	2.44	2.43	2.41	2.39

Type... Pond Routed HYG (total out)
 Name... HUTCH LAKE OUT Tag: C 100Y
 File... C:\HAESTAD\PPKW\SAMPLE\HUTCH.PPW
 Storm... C 100YR Tag: C 100Y

HYDROGRAPH ORDINATES (cfs)
 Output Time increment = 1.00 min
 Time on left represents time for first value in each row.

Time min					
400.00	2.38	2.36	2.34	2.33	2.31
405.00	2.29	2.28	2.26	2.24	2.23
410.00	2.21	2.20	2.18	2.17	2.15
415.00	2.14	2.12	2.11	2.09	2.08
420.00	2.06	2.05	2.03	2.02	2.01
425.00	1.99	1.98	1.96	1.95	1.94
430.00	1.92	1.91	1.90	1.88	1.87
435.00	1.86	1.84	1.83	1.82	1.80
440.00	1.79	1.78	1.77	1.75	1.74
445.00	1.73	1.72	1.70	1.69	1.68
450.00	1.67	1.66	1.64	1.63	1.62
455.00	1.61	1.60	1.59	1.58	1.56
460.00	1.55	1.54	1.53	1.52	1.51
465.00	1.50	1.49	1.48	1.47	1.46
470.00	1.45	1.44	1.43	1.42	1.41
475.00	1.40	1.39	1.38	1.37	1.36
480.00	1.35	1.34	1.33	1.32	1.31
485.00	1.30	1.29	1.28	1.27	1.26
490.00	1.25	1.24	1.24	1.23	1.22
495.00	1.21	1.20	1.19	1.18	1.18
500.00	1.17	1.16	1.15	1.14	1.13
505.00	1.13	1.12	1.11	1.10	1.09
510.00	1.09	1.08	1.07	1.06	1.06
515.00	1.05	1.04	1.03	1.03	1.02
520.00	1.01	1.00	1.00	.99	.98
525.00	.98	.97	.96	.95	.95
530.00	.94	.93	.93	.92	.91
535.00	.91	.90	.89	.89	.88
540.00	.88	.87	.86	.86	.85
545.00	.84	.84	.83	.83	.82
550.00	.81	.81	.80	.80	.79
555.00	.79	.78	.77	.77	.76
560.00	.76	.75	.75	.74	.74
565.00	.73	.73	.72	.71	.71
570.00	.70	.70	.69	.69	.68
575.00	.68	.67	.67	.66	.66
580.00	.66	.65	.65	.64	.64
585.00	.63	.63	.62	.62	.61
590.00	.61	.61	.60	.60	.59
595.00	.59	.58	.58	.58	.57
600.00	.57	.56	.56	.56	.55
605.00	.55	.54	.54	.54	.53
610.00	.53	.52	.52	.52	.51
615.00	.51	.51	.50	.50	.49
620.00	.49	.49	.48	.48	.48
625.00	.47	.47	.47	.46	.46
630.00	.46	.45	.45	.45	.44

Type... Pond Routed HYG (total out)
 Name... HUTCH LAKE OUT Tag: C 100Y
 File... C:\HAESTAD\PPKW\SAMPLE\HUTCH.PPW
 Storm... C 100YR Tag: C 100Y

HYDROGRAPH ORDINATES (cfs)
 Output Time increment = 1.00 min
 Time on left represents time for first value in each row.

Time min					
635.00	.44	.44	.43	.43	.43
640.00	.42	.42	.42	.42	.41
645.00	.41	.41	.40	.40	.40
650.00	.39	.39	.39	.39	.38
655.00	.38	.38	.37	.37	.37
660.00	.37	.36	.36	.36	.36
665.00	.35	.35	.35	.35	.34
670.00	.34	.34	.34	.33	.33
675.00	.33	.33	.32	.32	.32
680.00	.32	.31	.31	.31	.31
685.00	.31	.30	.30	.30	.30
690.00	.29	.29	.29	.29	.29
695.00	.28	.28	.28	.28	.28
700.00	.27	.27	.27	.27	.27
705.00	.26	.26	.26	.26	.26
710.00	.25	.25	.25	.25	.25
715.00	.25	.24	.24	.24	.24
720.00	.24	.24	.23	.23	.23
725.00	.23	.23	.23	.22	.22
730.00	.22	.22	.22	.22	.21
735.00	.21	.21	.21	.21	.21
740.00	.20	.20	.20	.20	.20
745.00	.20	.20	.19	.19	.19
750.00	.19	.19	.19	.19	.18
755.00	.18	.18	.18	.18	.18
760.00	.18	.18	.17	.17	.17
765.00	.17	.17	.17	.17	.17
770.00	.16	.16	.16	.16	.16
775.00	.16	.16	.16	.16	.15
780.00	.15	.15	.15	.15	.15
785.00	.15	.15	.15	.14	.14
790.00	.14	.14	.14	.14	.14
795.00	.14	.14	.14	.13	.13
800.00	.13	.13	.13	.13	.13
805.00	.13	.13	.13	.12	.12
810.00	.12	.12	.12	.12	.12
815.00	.12	.12	.12	.12	.12
820.00	.11	.11	.11	.11	.11
825.00	.11	.11	.11	.11	.11
830.00	.11	.11	.10	.10	.10
835.00	.10	.10	.10	.10	.10
840.00	.10	.10	.10	.10	.10
845.00	.10	.09	.09	.09	.09
850.00	.09	.09	.09	.09	.09
855.00	.09	.09	.09	.09	.09
860.00	.09	.08	.08	.08	.08
865.00	.08	.08	.08	.08	.08

Type.... Pond Routed HYG (total out)
 Name.... HUTCH LAKE OUT Tag: C 100Y
 File.... C:\HAESTAD\PPKW\SAMPLE\HUTCH.PPW
 Storm... C 100YR Tag: C 100Y

Page 4.20
 Event: C 100YR

HYDROGRAPH ORDINATES (cfs)						
Output Time increment = 1.00 min						
Time min	Time on left represents time for first value in each row.					
870.00	.08	.08	.08	.08	.08	.08
875.00	.08	.08	.08	.08	.07	.07
880.00	.07	.07	.07	.07	.07	.07
885.00	.07	.07	.07	.07	.07	.07
890.00	.07	.07	.07	.07	.07	.07
895.00	.07	.07	.07	.07	.06	.06
900.00	.06	.06	.06	.06	.06	.06
905.00	.06	.06	.06	.06	.06	.06
910.00	.06	.06	.06	.06	.06	.06
915.00	.06	.06	.06	.06	.06	.06
920.00	.06	.05	.05	.05	.05	.05
925.00	.05	.05	.05	.05	.05	.05
930.00	.05	.05	.05	.05	.05	.05
935.00	.05	.05	.05	.05	.05	.05
940.00	.05	.05	.05	.05	.05	.05
945.00	.05	.05	.05	.05	.04	.04
950.00	.04	.04	.04	.04	.04	.04
955.00	.04	.04	.04	.04	.04	.04
960.00	.04	.04	.04	.04	.04	.04
965.00	.04	.04	.04	.04	.04	.04
970.00	.04	.04	.04	.04	.04	.04
975.00	.04	.04	.04	.04	.04	.04
980.00	.04	.04	.04	.04	.03	.03
985.00	.03	.03	.03	.03	.03	.03
990.00	.03	.03	.03	.03	.03	.03
995.00	.03	.03	.03	.03	.03	.03
1000.00	.03	.03	.03	.03	.03	.03
1005.00	.03	.03	.03	.03	.03	.03
1010.00	.03	.03	.03	.03	.03	.03
1015.00	.03	.03	.03	.03	.03	.03
1020.00	.03	.03	.03	.03	.03	.03
1025.00	.03	.03	.03	.03	.03	.02
1030.00	.02	.02	.02	.02	.02	.02
1035.00	.02	.02	.02	.02	.02	.02
1040.00	.02	.02	.02	.02	.02	.02
1045.00	.02	.02	.02	.02	.02	.02
1050.00	.02	.02	.02	.02	.02	.02
1055.00	.02	.02	.02	.02	.02	.02
1060.00	.02	.02	.02	.02	.02	.02
1065.00	.02	.02	.02	.02	.02	.02
1070.00	.02	.02	.02	.02	.02	.02
1075.00	.02	.02	.02	.02	.02	.02
1080.00	.02	.02	.02	.02	.02	.02
1085.00	.02	.02	.02	.02	.02	.02
1090.00	.02	.02	.02	.02	.02	.02
1095.00	.02	.02	.02	.02	.02	.01
1100.00	.01	.01	.01	.01	.01	.01

Type.... Pond Routed HYG (total out)
 Name.... HUTCH LAKE OUT Tag: C 100Y
 File.... C:\HAESTAD\PPKW\SAMPLE\HUTCH.PPW
 Storm... C 100YR Tag: C 100Y

HYDROGRAPH ORDINATES (cfs)
 Output Time increment = 1.00 min
 Time on left represents time for first value in each row.

Time min					
1105.00	.01	.01	.01	.01	.01
1110.00	.01	.01	.01	.01	.01
1115.00	.01	.01	.01	.01	.01
1120.00	.01	.01	.01	.01	.01
1125.00	.01	.01	.01	.01	.01
1130.00	.01	.01	.01	.01	.01
1135.00	.01	.01	.01	.01	.01
1140.00	.01	.01	.01	.01	.01
1145.00	.01	.01	.01	.01	.01
1150.00	.01	.01	.01	.01	.01
1155.00	.01	.01	.01	.01	.01
1160.00	.01	.01	.01	.01	.01
1165.00	.01	.01	.01	.01	.01
1170.00	.01	.01	.01	.01	.01
1175.00	.01	.01	.01	.01	.01
1180.00	.01	.01	.01	.01	.01
1185.00	.01	.01	.01	.01	.01
1190.00	.01	.01	.01	.01	.01
1195.00	.01	.01	.01	.01	.01
1200.00	.01	.01	.01	.01	.01
1205.00	.01	.01	.01	.01	.01
1210.00	.01	.01	.01	.01	.01
1215.00	.01	.01	.01	.01	.01
1220.00	.01	.01	.01	.01	.01
1225.00	.01	.01	.01	.01	.01
1230.00	.01	.01	.01	.01	.01
1235.00	.01	.01	.01	.01	.01
1240.00	.01	.01	.01	.01	.01
1245.00	.01	.01	.01	.01	.01
1250.00	.00	.00	.00	.00	.00
1255.00	.00	.00	.00	.00	.00
1260.00	.00	.00	.00	.00	.00
1265.00	.00	.00	.00	.00	.00
1270.00	.00	.00	.00	.00	.00
1275.00	.00	.00	.00	.00	.00
1280.00	.00	.00	.00	.00	.00
1285.00	.00	.00	.00	.00	.00
1290.00	.00	.00	.00	.00	.00
1295.00	.00	.00	.00	.00	.00
1300.00	.00	.00	.00	.00	.00
1305.00	.00	.00	.00	.00	.00
1310.00	.00	.00	.00	.00	.00
1315.00	.00	.00	.00	.00	.00
1320.00	.00	.00	.00	.00	.00

Index of Starting Page Numbers for ID Names

----- 2 -----

20 INFLOWS A 15YR... 1.01, 1.03,
1.05

----- H -----

HUTCH LAKE... 2.01, 4.01, 4.02,
4.08, 4.09, 4.15, 4.16

----- L -----

LAKE OUTFALL... 3.01, 3.03

POND7
Reanalysis of Estates at Legacy Pointe Basin
15, 25 and 100 Year 20 Minute Design Storms

Table of Contents

***** RUNOFF HYDROGRAPHS *****

INFLOW-BASIN B.. B-15 Y
 Read HYG 1.01

INFLOW-BASIN B.. C-25 Y
 Read HYG 1.02

INFLOW-BASIN B.. D-100
 Read HYG 1.03

***** POND VOLUMES *****

BASIN A..... Vol: Planimeter 2.01

***** OUTLET STRUCTURES *****

BASIN A - OS 141 Outlet Input Data 3.01
 Composite Rating Curve 3.04

***** POND ROUTING *****

BASIN B OUT B-15 Y
 Pond Routing Summary 4.01
 Pond Routed HYG (total out) 4.02

BASIN B OUT C-25 Y
 Pond Routing Summary 4.05
 Pond Routed HYG (total out) 4.06

BASIN B OUT D-100
 Pond Routing Summary 4.09
 Pond Routed HYG (total out) 4.10

Type.... Read HYG Page 1.01
 Name.... INFLOW-BASIN B Event: B-15 Year yr
 File.... E:\PONDPACK\10589\LEGACY POINTE PHASE 2.PPW
 Storm... Tag: B-15 Y

HYG file = E:\PONDPACK\10589\10589C15.HYG
 HYG ID = 15 Year Inflow
 HYG Tag = 15 Yea

 Peak Discharge = 69.98 cfs
 Time to Peak = 8.00 min
 HYG Volume = 1.928 ac-ft

HYDROGRAPH ORDINATES (cfs)
 Output Time increment = 4.00 min
 Time on left represents time for first value in each row.

Time min					
.00	.00	34.99	69.98	69.98	69.98
20.00	69.98	34.99	.00	.00	.00
40.00	.00	.00	.00	.00	.00
60.00	.00	.00	.00	.00	.00
80.00	.00	.00	.00	.00	.00
100.00	.00	.00	.00	.00	.00
120.00	.00	.00	.00	.00	.00
140.00	.00	.00	.00	.00	.00
160.00	.00	.00	.00	.00	.00
180.00	.00	.00	.00	.00	.00
200.00	.00	.00	.00	.00	.00
220.00	.00	.00	.00	.00	.00
240.00	.00	.00	.00	.00	.00

Type... Read HYG

Name... INFLOW-BASIN B

Event: C-25 Year yr

File... E:\PONDPACK\10589\LEGACY POINTE PHASE 2.PPW

Storm... Tag: C-25 Y

HYG file = E:\PONDPACK\10589\10589C25.HYG

HYG ID = 25 Year Inflow

HYG Tag = 25 YR

Peak Discharge = 86.41 cfs
 Time to Peak = 8.00 min
 HYG Volume = 2.380 ac-ft

HYDROGRAPH ORDINATES (cfs)

Output Time increment = 4.00 min

Time on left represents time for first value in each row.

Time min					
.00	.00	43.21	86.41	86.41	86.41
20.00	86.41	43.21	.00	.00	.00
40.00	.00	.00	.00	.00	.00
60.00	.00	.00	.00	.00	.00
80.00	.00	.00	.00	.00	.00
100.00	.00	.00	.00	.00	.00
120.00	.00	.00	.00	.00	.00
140.00	.00	.00	.00	.00	.00
160.00	.00	.00	.00	.00	.00
180.00	.00	.00	.00	.00	.00
200.00	.00	.00	.00	.00	.00
220.00	.00	.00	.00	.00	.00
240.00	.00	.00	.00	.00	.00

Type.... Read HYG

Name.... INFLOW-BASIN B

Event: D-100 Year yr

File.... E:\PONDPACK\10589\LEGACY POINTE PHASE 2.PPW

Storm... Tag: D-100

HYG file = E:\PONDPACK\10589\10589C10.HYG

HYG ID = 100 Year Inflow

HYG Tag = 100 YR

Peak Discharge = 110.54 cfs

Time to Peak = 8.00 min

HYG Volume = 3.045 ac-ft

HYDROGRAPH ORDINATES (cfs)

Output Time increment = 4.00 min

Time on left represents time for first value in each row.

Time min					
.00	.00	55.27	110.54	110.54	110.54
20.00	110.54	55.27	.00	.00	.00
40.00	.00	.00	.00	.00	.00
60.00	.00	.00	.00	.00	.00
80.00	.00	.00	.00	.00	.00
100.00	.00	.00	.00	.00	.00
120.00	.00	.00	.00	.00	.00
140.00	.00	.00	.00	.00	.00
160.00	.00	.00	.00	.00	.00
180.00	.00	.00	.00	.00	.00
200.00	.00	.00	.00	.00	.00
220.00	.00	.00	.00	.00	.00
240.00	.00	.00	.00	.00	.00

Type.... Vol: Planimeter
Name.... BASIN A

File.... E:\PONDPACK\10589\LEGACY POINTE PHASE 2.PPW
Title... Basin A Pond Volume

POND VOLUME CALCULATIONS

Planimeter scale: 1.00 ft/in

Elevation (ft)	Planimeter (sq.in)	Area (acres)	$A1+A2+\text{sqr}(A1*A2)$ (acres)	Volume (ac-ft)	Volume Sum (ac-ft)
579.00	7668.100	.1760	.0000	.000	.000
580.00	11120.970	.2553	.6433	.214	.214
582.00	13677.310	.3140	.8524	.568	.783
584.00	16613.540	.3814	1.0414	.694	1.477

POND VOLUME EQUATIONS

* Incremental volume computed by the Conic Method for Reservoir Volumes.

$$\text{Volume} = (1/3) * (\text{EL2}-\text{EL1}) * (\text{Area1} + \text{Area2} + \text{sq.rt.}(\text{Area1}*\text{Area2}))$$

where: EL1, EL2 = Lower and upper elevations of the increment
Area1, Area2 = Areas computed for EL1, EL2, respectively
Volume = Incremental volume between EL1 and EL2

Type... Outlet Input Data
Name... BASIN A - OS 141

File... E:\PONDPACK\10589\LEGACY POINTE PHASE 2.PPW
Title... Outfall Structure 141

REQUESTED POND WS ELEVATIONS:

Min. Elev.= 579.00 ft
Increment = .20 ft
Max. Elev.= 584.00 ft

OUTLET CONNECTIVITY

---> Forward Flow Only (UpStream to DnStream)
<--- Reverse Flow Only (DnStream to UpStream)
<---> Forward and Reverse Both Allowed

Structure	No.		Outfall	E1, ft	E2, ft
-----	-----		-----	-----	-----
Weir-Rectangular	SI	--->	CV	582.400	584.000
Weir-Rectangular	SL	--->	CV	579.000	584.000
Culvert-Circular	CV	--->	TW	574.850	584.000
TW SETUP, DS Channel					

Type... Outlet Input Data
Name... BASIN A - OS 141

File... E:\PONDPACK\10589\LEGACY POINTE PHASE 2.PPW
Title... Outfall Structure 141

OUTLET STRUCTURE INPUT DATA

Structure ID = SI
Structure Type = Weir-Rectangular

of Openings = 1
Crest Elev. = 582.40 ft
Weir Length = 18.76 ft
Weir Coeff. = 3.000000

Weir TW effects (Use adjustment equation)

Structure ID = SL
Structure Type = Weir-Rectangular

of Openings = 1
Crest Elev. = 579.00 ft
Weir Length = 1.50 ft
Weir Coeff. = 3.000000

Weir TW effects (Use adjustment equation)

Type.... Outlet Input Data
Name.... BASIN A - OS 141

File.... E:\PONDPACK\10589\LEGACY POINTE PHASE 2.PPW
Title... Outfall Structure 141

OUTLET STRUCTURE INPUT DATA

Structure ID = CV
Structure Type = Culvert-Circular

No. Barrels = 1
Barrel Diameter = 3.5000 ft
Upstream Invert = 574.85 ft
Dnstream Invert = 573.81 ft
Horiz. Length = 104.19 ft
Barrel Length = 104.20 ft
Barrel Slope = .00998 ft/ft

OUTLET CONTROL DATA...

Mannings n = .0130
Ke = .5000 (forward entrance loss)
Kb = .005885 (per ft of full flow)
Kr = .5000 (reverse entrance loss)
HW Convergence = .050 +/- ft

INLET CONTROL DATA...

Equation form = 1
Inlet Control K = .0078
Inlet Control M = 2.0000
Inlet Control c = .02920
Inlet Control Y = .7400
T1 ratio (HW/D) = 1.131
T2 ratio (HW/D) = 1.202
Slope Factor = -.500
Calc inlet only = Yes

Use unsubmerged inlet control Form 1 equ. below T1 elev.

Use submerged inlet control Form 1 equ. above T2 elev.

In transition zone between unsubmerged and submerged inlet control,
interpolate between flows at T1 & T2...

At T1 Elev = 578.81 ft ---> Flow = 63.00 cfs
At T2 Elev = 579.06 ft ---> Flow = 72.00 cfs

Structure ID = TW
Structure Type = TW SETUP, DS Channel

FREE OUTFALL CONDITIONS SPECIFIED

CONVERGENCE TOLERANCES...

Maximum Iterations= 30
Min. TW tolerance = .10 ft
Max. TW tolerance = .10 ft
Min. HW tolerance = .10 ft
Max. HW tolerance = .10 ft
Min. Q tolerance = .10 cfs
Max. Q tolerance = .10 cfs

Type.... Composite Rating Curve
 Name.... BASIN A - OS 141

File.... E:\PONDPACK\10589\LEGACY POINTE PHASE 2.PPW
 Title... Outfall Structure 141

***** COMPOSITE OUTFLOW SUMMARY *****

WS Elev, Total Q		Converge		Notes
Elev. ft	Q cfs	TW Elev ft	Error +/-ft	Contributing Structures
579.00	.00	Free	Outfall	(no Q: SI,SL,CV)
579.20	.40	Free	Outfall	SL,CV (no Q: SI)
579.40	1.14	Free	Outfall	SL,CV (no Q: SI)
579.60	2.09	Free	Outfall	SL,CV (no Q: SI)
579.80	3.22	Free	Outfall	SL,CV (no Q: SI)
580.00	4.50	Free	Outfall	SL,CV (no Q: SI)
580.20	5.92	Free	Outfall	SL,CV (no Q: SI)
580.40	7.45	Free	Outfall	SL,CV (no Q: SI)
580.60	9.11	Free	Outfall	SL,CV (no Q: SI)
580.80	10.87	Free	Outfall	SL,CV (no Q: SI)
581.00	12.73	Free	Outfall	SL,CV (no Q: SI)
581.20	14.68	Free	Outfall	SL,CV (no Q: SI)
581.40	16.73	Free	Outfall	SL,CV (no Q: SI)
581.60	18.87	Free	Outfall	SL,CV (no Q: SI)
581.80	21.08	Free	Outfall	SL,CV (no Q: SI)
582.00	23.38	Free	Outfall	SL,CV (no Q: SI)
582.20	25.76	Free	Outfall	SL,CV (no Q: SI)
582.40	28.21	Free	Outfall	SL,CV (no Q: SI)
582.60	35.77	Free	Outfall	SI,SL,CV
582.80	47.57	Free	Outfall	SI,SL,CV
583.00	62.15	Free	Outfall	SI,SL,CV
583.20	78.58	Free	Outfall	SI,SL,CV
583.40	95.28	Free	Outfall	SI,SL,CV
583.60	111.48	Free	Outfall	SI,SL,CV
583.80	126.69	Free	Outfall	SI,SL,CV
584.00	132.48	Free	Outfall	SI,SL,CV

Type.... Pond Routing Summary Page 4.01
 Name.... BASIN B OUT Tag: B-15 Y Event: B-15 Year yr
 File.... E:\PONDPACK\10589\LEGACY POINTE PHASE 2.PPW
 Storm... B-15 Year Tag: B-15 Y

LEVEL POOL ROUTING SUMMARY

HYG Dir = E:\PONDPACK\10589\
 Inflow HYG file = NONE STORED - BASIN B IN B-15 Y
 Outflow HYG file = NONE STORED - BASIN B OUT B-15 Y

Pond Node Data = BASIN B
 Pond Volume Data = BASIN A
 Pond Outlet Data = BASIN A - OS 141

No Infiltration

INITIAL CONDITIONS

 Starting WS Elev = 579.00 ft
 Starting Volume = .000 ac-ft
 Starting Outflow = .00 cfs
 Starting Infiltr. = .00 cfs
 Starting Total Qout= .00 cfs
 Time Increment = 1.00 min

INFLOW/OUTFLOW HYDROGRAPH SUMMARY

=====
 Peak Inflow = 69.98 cfs at 8.00 min
 Peak Outflow = 56.93 cfs at 21.00 min

 Peak Elevation = 582.93 ft
 Peak Storage = 1.088 ac-ft
 =====

MASS BALANCE (ac-ft)

 + Initial Vol = .000
 + HYG Vol IN = 1.928
 - Infiltration = .000
 - HYG Vol OUT = 1.928
 - Retained Vol = .000

 Unrouted Vol = -.000 ac-ft (.001% of Inflow Volume)

Type.... Pond Routed HYG (total out) Page 4.02
 Name.... BASIN B OUT Tag: B-15 Y Event: B-15 Year yr
 File.... E:\PONDPACK\10589\LEGACY POINTE PHASE 2.PPW
 Storm... B-15 Year Tag: B-15 Y

POND ROUTED TOTAL OUTFLOW HYG...

HYG file =
 HYG ID = BASIN B OUT
 HYG Tag = B-15 Y

 Peak Discharge = 56.93 cfs
 Time to Peak = 21.00 min
 HYG Volume = 1.928 ac-ft

HYDROGRAPH ORDINATES (cfs)

Output Time increment = 1.00 min
 Time on left represents time for first value in each row.

Time min					
.00	.00	.07	.26	.71	1.53
5.00	2.73	4.30	6.25	8.65	11.29
10.00	13.94	16.56	19.12	21.62	24.03
15.00	26.35	29.23	35.18	42.39	48.47
20.00	53.96	56.93	56.91	54.67	50.76
25.00	45.93	40.75	35.11	30.62	27.49
30.00	26.09	24.78	23.53	22.36	21.25
35.00	20.21	19.22	18.29	17.41	16.58
40.00	15.80	15.06	14.36	13.70	13.07
45.00	12.48	11.92	11.39	10.88	10.41
50.00	9.96	9.53	9.12	8.74	8.38
55.00	8.04	7.70	7.39	7.10	6.82
60.00	6.55	6.29	6.04	5.81	5.60
65.00	5.39	5.19	5.00	4.81	4.63
70.00	4.46	4.31	4.16	4.01	3.87
75.00	3.73	3.60	3.48	3.35	3.24
80.00	3.13	3.02	2.92	2.83	2.73
85.00	2.64	2.55	2.47	2.39	2.31
90.00	2.23	2.16	2.09	2.02	1.96
95.00	1.90	1.84	1.79	1.73	1.68
100.00	1.63	1.58	1.53	1.49	1.44
105.00	1.40	1.36	1.32	1.28	1.24
110.00	1.20	1.16	1.13	1.10	1.07
115.00	1.05	1.02	.99	.97	.95
120.00	.92	.90	.88	.85	.83
125.00	.81	.79	.77	.75	.73
130.00	.71	.70	.68	.66	.64
135.00	.63	.61	.60	.58	.57
140.00	.55	.54	.53	.51	.50
145.00	.49	.47	.46	.45	.44
150.00	.43	.42	.41	.40	.39
155.00	.39	.38	.38	.37	.36
160.00	.36	.35	.35	.34	.34

HYDROGRAPH ORDINATES (cfs)
 Output Time increment = 1.00 min
 Time on left represents time for first value in each row.

Time min					
165.00	.33	.33	.32	.32	.31
170.00	.31	.30	.30	.29	.29
175.00	.29	.28	.28	.27	.27
180.00	.27	.26	.26	.25	.25
185.00	.25	.24	.24	.23	.23
190.00	.23	.22	.22	.22	.21
195.00	.21	.21	.21	.20	.20
200.00	.20	.19	.19	.19	.18
205.00	.18	.18	.18	.17	.17
210.00	.17	.17	.16	.16	.16
215.00	.16	.15	.15	.15	.15
220.00	.14	.14	.14	.14	.14
225.00	.13	.13	.13	.13	.13
230.00	.12	.12	.12	.12	.12
235.00	.12	.11	.11	.11	.11
240.00	.11	.11	.10	.10	.10
245.00	.10	.10	.10	.09	.09
250.00	.09	.09	.09	.09	.09
255.00	.09	.08	.08	.08	.08
260.00	.08	.08	.08	.08	.07
265.00	.07	.07	.07	.07	.07
270.00	.07	.07	.07	.06	.06
275.00	.06	.06	.06	.06	.06
280.00	.06	.06	.06	.06	.06
285.00	.05	.05	.05	.05	.05
290.00	.05	.05	.05	.05	.05
295.00	.05	.05	.05	.04	.04
300.00	.04	.04	.04	.04	.04
305.00	.04	.04	.04	.04	.04
310.00	.04	.04	.04	.04	.03
315.00	.03	.03	.03	.03	.03
320.00	.03	.03	.03	.03	.03
325.00	.03	.03	.03	.03	.03
330.00	.03	.03	.03	.03	.03
335.00	.03	.03	.02	.02	.02
340.00	.02	.02	.02	.02	.02
345.00	.02	.02	.02	.02	.02
350.00	.02	.02	.02	.02	.02
355.00	.02	.02	.02	.02	.02
360.00	.02	.02	.02	.02	.02
365.00	.02	.02	.02	.02	.02
370.00	.01	.01	.01	.01	.01
375.00	.01	.01	.01	.01	.01
380.00	.01	.01	.01	.01	.01
385.00	.01	.01	.01	.01	.01
390.00	.01	.01	.01	.01	.01
395.00	.01	.01	.01	.01	.01

Type.... Pond Routed HYG (total out) Page 4.04
 Name.... BASIN B OUT Tag: B-15 Y Event: B-15 Year yr
 File.... E:\PONDPACK\10589\LEGACY POINTE PHASE 2.PPW
 Storm... B-15 Year Tag: B-15 Y

HYDROGRAPH ORDINATES (cfs)
 Output Time increment = 1.00 min
 Time on left represents time for first value in each row.

Time min					
400.00	.01	.01	.01	.01	.01
405.00	.01	.01	.01	.01	.01
410.00	.01	.01	.01	.01	.01
415.00	.01	.01	.01	.01	.01
420.00	.01	.01	.01	.01	.01
425.00	.01	.01	.01	.01	.01
430.00	.01	.01	.01	.01	.01
435.00	.01	.01	.01	.01	.01
440.00	.01	.01	.01	.00	.00
445.00	.00	.00	.00	.00	.00
450.00	.00	.00	.00	.00	.00
455.00	.00	.00	.00	.00	.00
460.00	.00	.00	.00	.00	.00
465.00	.00	.00	.00	.00	.00
470.00	.00	.00	.00	.00	.00
475.00	.00	.00	.00		

Type... Pond Routing Summary Page 4.05
Name... BASIN B OUT Tag: C-25 Y Event: C-25 Year yr
File... E:\PONDPACK\10589\LEGACY POINTE PHASE 2.PPW
Storm... C-25 Year Tag: C-25 Y

LEVEL POOL ROUTING SUMMARY

HYG Dir = E:\PONDPACK\10589\
Inflow HYG file = NONE STORED - BASIN B IN C-25 Y
Outflow HYG file = NONE STORED - BASIN B OUT C-25 Y

Pond Node Data = BASIN B
Pond Volume Data = BASIN A
Pond Outlet Data = BASIN A - OS 141

No Infiltration

INITIAL CONDITIONS

Starting WS Elev = 579.00 ft
Starting Volume = .000 ac-ft
Starting Outflow = .00 cfs
Starting Infiltr. = .00 cfs
Starting Total Qout = .00 cfs
Time Increment = 1.00 min

INFLOW/OUTFLOW HYDROGRAPH SUMMARY

=====
Peak Inflow = 86.41 cfs at 8.00 min
Peak Outflow = 78.87 cfs at 21.00 min

Peak Elevation = 583.20 ft
Peak Storage = 1.184 ac-ft
=====

MASS BALANCE (ac-ft)

+ Initial Vol = .000
+ HYG Vol IN = 2.380
- Infiltration = .000
- HYG Vol OUT = 2.380
- Retained Vol = .000

Unrouted Vol = -.000 ac-ft (.001% of Inflow Volume)

Type.... Pond Routed HYG (total out) Page 4.06
 Name.... BASIN B OUT Tag: C-25 Y Event: C-25 Year yr
 File.... E:\PONDPACK\10589\LEGACY POINTE PHASE 2.PPW
 Storm... C-25 Year Tag: C-25 Y

POND ROUTED TOTAL OUTFLOW HYG...

HYG file =
 HYG ID = BASIN B OUT
 HYG Tag = C-25 Y

 Peak Discharge = 78.87 cfs
 Time to Peak = 21.00 min
 HYG Volume = 2.380 ac-ft

HYDROGRAPH ORDINATES (cfs)

Output Time increment = 1.00 min
 Time on left represents time for first value in each row.

Time min	.00	.08	.32	.94	2.02
5.00	3.58	5.60	8.15	11.27	14.67
10.00	18.08	21.41	24.65	27.78	35.54
15.00	46.38	56.37	64.21	70.38	74.83
20.00	78.05	78.87	76.47	71.72	65.30
25.00	58.03	50.11	42.42	34.87	29.78
30.00	27.24	25.86	24.56	23.32	22.16
35.00	21.06	20.03	19.05	18.13	17.26
40.00	16.44	15.67	14.93	14.24	13.59
45.00	12.96	12.38	11.83	11.30	10.80
50.00	10.33	9.89	9.46	9.05	8.68
55.00	8.32	7.98	7.65	7.34	7.05
60.00	6.77	6.50	6.25	6.00	5.77
65.00	5.56	5.35	5.15	4.96	4.78
70.00	4.60	4.44	4.28	4.13	3.98
75.00	3.84	3.71	3.58	3.45	3.33
80.00	3.22	3.11	3.01	2.91	2.81
85.00	2.72	2.63	2.54	2.45	2.37
90.00	2.29	2.22	2.14	2.07	2.01
95.00	1.95	1.89	1.83	1.78	1.73
100.00	1.67	1.62	1.57	1.53	1.48
105.00	1.44	1.39	1.35	1.31	1.27
110.00	1.23	1.19	1.16	1.13	1.10
115.00	1.07	1.04	1.02	.99	.97
120.00	.94	.92	.89	.87	.85
125.00	.83	.81	.79	.77	.75
130.00	.73	.71	.69	.67	.66
135.00	.64	.63	.61	.59	.58
140.00	.56	.55	.54	.52	.51
145.00	.50	.48	.47	.46	.45
150.00	.44	.43	.42	.40	.40
155.00	.39	.39	.38	.37	.37
160.00	.36	.36	.35	.35	.34

Type... Pond Routed HYG (total out) Page 4.07
 Name... BASIN B OUT Tag: C-25 Y Event: C-25 Year yr
 File... E:\PONDPACK\10589\LEGACY POINTE PHASE 2.PPW
 Storm... C-25 Year Tag: C-25 Y

HYDROGRAPH ORDINATES (cfs)
 Output Time increment = 1.00 min
 Time on left represents time for first value in each row.

Time min					
165.00	.34	.33	.33	.32	.32
170.00	.31	.31	.30	.30	.29
175.00	.29	.29	.28	.28	.27
180.00	.27	.26	.26	.26	.25
185.00	.25	.25	.24	.24	.23
190.00	.23	.23	.22	.22	.22
195.00	.21	.21	.21	.20	.20
200.00	.20	.20	.19	.19	.19
205.00	.18	.18	.18	.18	.17
210.00	.17	.17	.17	.16	.16
215.00	.16	.16	.15	.15	.15
220.00	.15	.14	.14	.14	.14
225.00	.14	.13	.13	.13	.13
230.00	.13	.12	.12	.12	.12
235.00	.12	.12	.11	.11	.11
240.00	.11	.11	.11	.10	.10
245.00	.10	.10	.10	.10	.09
250.00	.09	.09	.09	.09	.09
255.00	.09	.09	.08	.08	.08
260.00	.08	.08	.08	.08	.08
265.00	.07	.07	.07	.07	.07
270.00	.07	.07	.07	.07	.06
275.00	.06	.06	.06	.06	.06
280.00	.06	.06	.06	.06	.06
285.00	.05	.05	.05	.05	.05
290.00	.05	.05	.05	.05	.05
295.00	.05	.05	.05	.05	.04
300.00	.04	.04	.04	.04	.04
305.00	.04	.04	.04	.04	.04
310.00	.04	.04	.04	.04	.04
315.00	.03	.03	.03	.03	.03
320.00	.03	.03	.03	.03	.03
325.00	.03	.03	.03	.03	.03
330.00	.03	.03	.03	.03	.03
335.00	.03	.03	.02	.02	.02
340.00	.02	.02	.02	.02	.02
345.00	.02	.02	.02	.02	.02
350.00	.02	.02	.02	.02	.02
355.00	.02	.02	.02	.02	.02
360.00	.02	.02	.02	.02	.02
365.00	.02	.02	.02	.02	.02
370.00	.02	.01	.01	.01	.01
375.00	.01	.01	.01	.01	.01
380.00	.01	.01	.01	.01	.01
385.00	.01	.01	.01	.01	.01
390.00	.01	.01	.01	.01	.01
395.00	.01	.01	.01	.01	.01

S/N: f21101d06a84 Bax Engineering Date: 08-14-2002
 PondPack Ver: 7.0 (325) Compute Time: 13:02:58

Type.... Pond Routed HYG (total out) Page 4.08
 Name.... BASIN B OUT Tag: C-25 Y Event: C-25 Year yr
 File.... E:\PONDPACK\10589\LEGACY POINTE PHASE 2.PPW
 Storm... C-25 Year Tag: C-25 Y

HYDROGRAPH ORDINATES (cfs)
 Output Time increment = 1.00 min
 Time on left represents time for first value in each row.

Time min					
400.00	.01	.01	.01	.01	.01
405.00	.01	.01	.01	.01	.01
410.00	.01	.01	.01	.01	.01
415.00	.01	.01	.01	.01	.01
420.00	.01	.01	.01	.01	.01
425.00	.01	.01	.01	.01	.01
430.00	.01	.01	.01	.01	.01
435.00	.01	.01	.01	.01	.01
440.00	.01	.01	.01	.01	.00
445.00	.00	.00	.00	.00	.00
450.00	.00	.00	.00	.00	.00
455.00	.00	.00	.00	.00	.00
460.00	.00	.00	.00	.00	.00
465.00	.00	.00	.00	.00	.00
470.00	.00	.00	.00	.00	.00
475.00	.00	.00	.00	.00	.00

Type.... Pond Routing Summary Page 4.09
 Name.... BASIN B OUT Tag: D-100 Event: D-100 Year yr
 File.... E:\PONDPACK\10589\LEGACY POINTE PHASE 2.PPW
 Storm... D-100 Year Tag: D-100

LEVEL POOL ROUTING SUMMARY

HYG Dir = E:\PONDPACK\10589\
 Inflow HYG file = NONE STORED - BASIN B IN D-100
 Outflow HYG file = NONE STORED - BASIN B OUT D-100

Pond Node Data = BASIN B
 Pond Volume Data = BASIN A
 Pond Outlet Data = BASIN A - OS 141

No Infiltration

INITIAL CONDITIONS

 Starting WS Elev = 579.00 ft
 Starting Volume = .000 ac-ft
 Starting Outflow = .00 cfs
 Starting Infiltr. = .00 cfs
 Starting Total Qout = .00 cfs
 Time Increment = 1.00 min

INFLOW/OUTFLOW HYDROGRAPH SUMMARY

=====
 Peak Inflow = 110.54 cfs at 8.00 min
 Peak Outflow = 105.11 cfs at 20.00 min

 Peak Elevation = 583.52 ft
 Peak Storage = 1.298 ac-ft
 =====

MASS BALANCE (ac-ft)

 + Initial Vol = .000
 + HYG Vol IN = 3.045
 - Infiltration = .000
 - HYG Vol OUT = 3.045
 - Retained Vol = .000

 Unrouted Vol = -.000 ac-ft (.000% of Inflow Volume)

Type.... Pond Routed HYG (total out) Page 4.10
 Name.... BASIN B OUT Tag: D-100 Event: D-100 Year yr
 File.... E:\PONDPACK\10589\LEGACY POINTE PHASE 2.PPW
 Storm... D-100 Year Tag: D-100

POND ROUTED TOTAL OUTFLOW HYG...

HYG file =
 HYG ID = BASIN B OUT
 HYG Tag = D-100

 Peak Discharge = 105.11 cfs
 Time to Peak = 20.00 min
 HYG Volume = 3.045 ac-ft

HYDROGRAPH ORDINATES (cfs)

Output Time increment = 1.00 min
 Time on left represents time for first value in each row.

Time min					
.00	.00	.10	.42	1.31	2.80
5.00	4.88	7.62	11.11	15.32	19.89
10.00	24.38	29.75	44.29	60.59	74.33
15.00	84.39	91.64	96.82	100.47	103.15
20.00	105.11	104.72	100.76	94.12	85.26
25.00	75.02	63.76	52.65	42.01	33.87
30.00	28.92	26.99	25.62	24.33	23.11
35.00	21.96	20.87	19.85	18.88	17.97
40.00	17.11	16.30	15.53	14.80	14.12
45.00	13.47	12.85	12.28	11.73	11.21
50.00	10.71	10.25	9.81	9.39	8.99
55.00	8.61	8.26	7.92	7.59	7.28
60.00	7.00	6.72	6.46	6.20	5.96
65.00	5.73	5.52	5.32	5.12	4.93
70.00	4.75	4.57	4.41	4.25	4.10
75.00	3.96	3.82	3.69	3.56	3.43
80.00	3.31	3.20	3.09	2.99	2.89
85.00	2.79	2.70	2.61	2.52	2.44
90.00	2.36	2.28	2.20	2.13	2.06
95.00	2.00	1.94	1.88	1.82	1.77
100.00	1.72	1.66	1.61	1.56	1.52
105.00	1.47	1.43	1.38	1.34	1.30
110.00	1.26	1.22	1.19	1.15	1.12
115.00	1.09	1.06	1.04	1.01	.99
120.00	.96	.94	.91	.89	.87
125.00	.85	.82	.80	.78	.76
130.00	.74	.73	.71	.69	.67
135.00	.65	.64	.62	.61	.59
140.00	.58	.56	.55	.53	.52
145.00	.51	.49	.48	.47	.46
150.00	.45	.44	.42	.41	.40
155.00	.40	.39	.38	.38	.37
160.00	.37	.36	.36	.35	.35

HYDROGRAPH ORDINATES (cfs)
 Output Time increment = 1.00 min
 Time on left represents time for first value in each row.

Time min					
165.00	.34	.34	.33	.33	.32
170.00	.32	.31	.31	.30	.30
175.00	.29	.29	.28	.28	.28
180.00	.27	.27	.26	.26	.26
185.00	.25	.25	.24	.24	.24
190.00	.23	.23	.23	.22	.22
195.00	.22	.21	.21	.21	.20
200.00	.20	.20	.19	.19	.19
205.00	.19	.18	.18	.18	.18
210.00	.17	.17	.17	.17	.16
215.00	.16	.16	.16	.15	.15
220.00	.15	.15	.14	.14	.14
225.00	.14	.14	.13	.13	.13
230.00	.13	.13	.12	.12	.12
235.00	.12	.12	.11	.11	.11
240.00	.11	.11	.11	.10	.10
245.00	.10	.10	.10	.10	.10
250.00	.09	.09	.09	.09	.09
255.00	.09	.09	.08	.08	.08
260.00	.08	.08	.08	.08	.08
265.00	.08	.07	.07	.07	.07
270.00	.07	.07	.07	.07	.07
275.00	.06	.06	.06	.06	.06
280.00	.06	.06	.06	.06	.06
285.00	.06	.05	.05	.05	.05
290.00	.05	.05	.05	.05	.05
295.00	.05	.05	.05	.05	.04
300.00	.04	.04	.04	.04	.04
305.00	.04	.04	.04	.04	.04
310.00	.04	.04	.04	.04	.04
315.00	.04	.03	.03	.03	.03
320.00	.03	.03	.03	.03	.03
325.00	.03	.03	.03	.03	.03
330.00	.03	.03	.03	.03	.03
335.00	.03	.03	.03	.02	.02
340.00	.02	.02	.02	.02	.02
345.00	.02	.02	.02	.02	.02
350.00	.02	.02	.02	.02	.02
355.00	.02	.02	.02	.02	.02
360.00	.02	.02	.02	.02	.02
365.00	.02	.02	.02	.02	.02
370.00	.02	.02	.01	.01	.01
375.00	.01	.01	.01	.01	.01
380.00	.01	.01	.01	.01	.01
385.00	.01	.01	.01	.01	.01
390.00	.01	.01	.01	.01	.01
395.00	.01	.01	.01	.01	.01

Type... Pond Routed HYG (total out) Page 4.12
 Name... BASIN B OUT Tag: D-100 Event: D-100 Year yr
 File... E:\PONDPACK\10589\LEGACY POINTE PHASE 2.PPW
 Storm... D-100 Year Tag: D-100

HYDROGRAPH ORDINATES (cfs)
 Output Time increment = 1.00 min
 Time on left represents time for first value in each row.

Time min					
400.00	.01	.01	.01	.01	.01
405.00	.01	.01	.01	.01	.01
410.00	.01	.01	.01	.01	.01
415.00	.01	.01	.01	.01	.01
420.00	.01	.01	.01	.01	.01
425.00	.01	.01	.01	.01	.01
430.00	.01	.01	.01	.01	.01
435.00	.01	.01	.01	.01	.01
440.00	.01	.01	.01	.01	.01
445.00	.00	.00	.00	.00	.00
450.00	.00	.00	.00	.00	.00
455.00	.00	.00	.00	.00	.00
460.00	.00	.00	.00	.00	.00
465.00	.00	.00	.00	.00	.00
470.00	.00	.00	.00	.00	.00
475.00	.00	.00	.00	.00	.00

Index of Starting Page Numbers for ID Names

----- B -----
BASIN A... 2.01
BASIN A - OS 141... 3.01, 3.04,
4.01, 4.02, 4.05, 4.06, 4.09,
4.10, 1.01, 1.02, 1.03

POND 7
Reanalysis of Avondale Phase 4 Basin
15, 25 and 100 Year 20 Minute Design Storms

Table of Contents

***** RUNOFF HYDROGRAPHS *****

20 MINUTE INFLOW A15yr
 Read HYG 1.01

20 MINUTE INFLOW B25yr
 Read HYG 1.03

20 MINUTE INFLOW C100yr
 Read HYG 1.05

***** POND VOLUMES *****

BASIN B..... Vol: Planimeter 2.01

***** OUTLET STRUCTURES *****

OS 59..... Composite Rating Curve 3.01

***** POND ROUTING *****

BASIN B OUT A15yr
 Pond Routed HYG (total out) 4.01

BASIN B OUT B25yr
 Pond Routed HYG (total out) 4.02

BASIN B OUT C100yr
 Pond Routed HYG (total out) 4.03

Type.... Read HYG
 Name.... 20 MINUTE INFLOW Tag: A15yr
 File.... C:\MY DOCUMENTS\PROJECT1.PPW
 Title... 15, 25 and 100 Year inflows to Basin B of Avondale
 Phase 4
 Storm... Tag: A15yr

HYG file = C:\MY DOCUMENTS\AV04B15.HYG
 HYG ID = Avon B 15 In
 HYG Tag = 15yr

 Peak Discharge = 24.10 cfs
 Time to Peak = 3.00 min
 HYG Volume = 28919 cu.ft

HYDROGRAPH ORDINATES (cfs)
 Output Time increment = 1.00 min
 Time on left represents time for first value in each row.

Time min					
.00	.00	8.03	16.06	24.10	24.10
5.00	24.10	24.10	24.10	24.10	24.10
10.00	24.10	24.10	24.10	24.10	24.10
15.00	24.10	24.10	24.10	24.10	24.10
20.00	24.10	16.06	8.03	.00	.00
25.00	.00	.00	.00	.00	.00
30.00	.00	.00	.00	.00	.00
35.00	.00	.00	.00	.00	.00
40.00	.00	.00	.00	.00	.00
45.00	.00	.00	.00	.00	.00
50.00	.00	.00	.00	.00	.00
55.00	.00	.00	.00	.00	.00
60.00	.00	.00	.00	.00	.00
65.00	.00	.00	.00	.00	.00
70.00	.00	.00	.00	.00	.00
75.00	.00	.00	.00	.00	.00
80.00	.00	.00	.00	.00	.00
85.00	.00	.00	.00	.00	.00
90.00	.00	.00	.00	.00	.00
95.00	.00	.00	.00	.00	.00
100.00	.00	.00	.00	.00	.00
105.00	.00	.00	.00	.00	.00
110.00	.00	.00	.00	.00	.00
115.00	.00	.00	.00	.00	.00
120.00	.00	.00	.00	.00	.00
125.00	.00	.00	.00	.00	.00
130.00	.00	.00	.00	.00	.00
135.00	.00	.00	.00	.00	.00
140.00	.00	.00	.00	.00	.00
145.00	.00	.00	.00	.00	.00
150.00	.00	.00	.00	.00	.00

Type.... Read HYG
 Name.... 20 MINUTE INFLOW Tag: A15yr
 File.... C:\MY DOCUMENTS\PROJECT1.PPW
 Title... 15, 25 and 100 Year inflows to Basin B of Avondale
 Phase 4
 Storm... Tag: A15yr

HYDROGRAPH ORDINATES (cfs)
 Output Time increment = 1.00 min
 Time on left represents time for first value in each row.

Time min					
155.00	.00	.00	.00	.00	.00
160.00	.00	.00	.00	.00	.00
165.00	.00	.00	.00	.00	.00
170.00	.00	.00	.00	.00	.00
175.00	.00	.00	.00	.00	.00
180.00	.00	.00	.00	.00	.00
185.00	.00	.00	.00	.00	.00
190.00	.00	.00	.00	.00	.00
195.00	.00	.00	.00	.00	.00
200.00	.00	.00	.00	.00	.00
205.00	.00	.00	.00	.00	.00
210.00	.00	.00	.00	.00	.00
215.00	.00	.00	.00	.00	.00
220.00	.00	.00	.00	.00	.00
225.00	.00	.00	.00	.00	.00
230.00	.00	.00	.00	.00	.00
235.00	.00	.00	.00	.00	.00
240.00	.00	.00	.00	.00	.00
245.00	.00	.00	.00	.00	.00
250.00	.00				

Type.... Read HYG
 Name.... 20 MINUTE INFLOW
 File.... C:\MY DOCUMENTS\PROJECT1.PPW
 Storm... Tag: B25yr

HYG file = C:\MY DOCUMENTS\AVO4B25.HYG
 HYG ID = Avon 4B 25 in
 HYG Tag = 25yr

 Peak Discharge = 29.76 cfs
 Time to Peak = 3.00 min
 HYG Volume = 35712 cu.ft

HYDROGRAPH ORDINATES (cfs)
 Output Time increment = 1.00 min
 Time on left represents time for first value in each row.

Time min	Output Time increment = 1.00 min				
.00	.00	9.92	19.84	29.76	29.76
5.00	29.76	29.76	29.76	29.76	29.76
10.00	29.76	29.76	29.76	29.76	29.76
15.00	29.76	29.76	29.76	29.76	29.76
20.00	29.76	19.84	9.92	.00	.00
25.00	.00	.00	.00	.00	.00
30.00	.00	.00	.00	.00	.00
35.00	.00	.00	.00	.00	.00
40.00	.00	.00	.00	.00	.00
45.00	.00	.00	.00	.00	.00
50.00	.00	.00	.00	.00	.00
55.00	.00	.00	.00	.00	.00
60.00	.00	.00	.00	.00	.00
65.00	.00	.00	.00	.00	.00
70.00	.00	.00	.00	.00	.00
75.00	.00	.00	.00	.00	.00
80.00	.00	.00	.00	.00	.00
85.00	.00	.00	.00	.00	.00
90.00	.00	.00	.00	.00	.00
95.00	.00	.00	.00	.00	.00
100.00	.00	.00	.00	.00	.00
105.00	.00	.00	.00	.00	.00
110.00	.00	.00	.00	.00	.00
115.00	.00	.00	.00	.00	.00
120.00	.00	.00	.00	.00	.00
125.00	.00	.00	.00	.00	.00
130.00	.00	.00	.00	.00	.00
135.00	.00	.00	.00	.00	.00
140.00	.00	.00	.00	.00	.00
145.00	.00	.00	.00	.00	.00
150.00	.00	.00	.00	.00	.00
155.00	.00	.00	.00	.00	.00
160.00	.00	.00	.00	.00	.00

Type.... Read HYG
Name.... 20 MINUTE INFLOW
File.... C:\MY DOCUMENTS\PROJECT1.PPW
Storm... Tag: B25yr

Page 1.04
Event: B25yr

HYDROGRAPH ORDINATES (cfs)
Output Time increment = 1.00 min
Time on left represents time for first value in each row.

Time min						
165.00		.00	.00	.00	.00	.00
170.00		.00	.00	.00	.00	.00
175.00		.00	.00	.00	.00	.00
180.00		.00	.00	.00	.00	.00
185.00		.00	.00	.00	.00	.00
190.00		.00	.00	.00	.00	.00
195.00		.00	.00	.00	.00	.00
200.00		.00	.00	.00	.00	.00
205.00		.00	.00	.00	.00	.00
210.00		.00	.00	.00	.00	.00
215.00		.00	.00	.00	.00	.00
220.00		.00	.00	.00	.00	.00
225.00		.00	.00	.00	.00	.00
230.00		.00	.00	.00	.00	.00
235.00		.00	.00	.00	.00	.00
240.00		.00	.00	.00	.00	.00
245.00		.00	.00	.00	.00	.00
250.00		.00				

Type.... Read HYG
 Name.... 20 MINUTE INFLOW
 File.... C:\MY DOCUMENTS\PROJECT1.PPW
 Storm... Tag: C100yr

HYG file = C:\MY DOCUMENTS\AV04B100.HYG
 HYG ID = Avon 4B 100 in
 HYG Tag = 100yr

 Peak Discharge = 38.07 cfs
 Time to Peak = 3.00 min
 HYG Volume = 45684 cu.ft

HYDROGRAPH ORDINATES (cfs)
 Output Time increment = 1.00 min
 Time on left represents time for first value in each row.

Time min					
.00	.00	12.69	25.38	38.07	38.07
5.00	38.07	38.07	38.07	38.07	38.07
10.00	38.07	38.07	38.07	38.07	38.07
15.00	38.07	38.07	38.07	38.07	38.07
20.00	38.07	25.38	12.69	.00	.00
25.00	.00	.00	.00	.00	.00
30.00	.00	.00	.00	.00	.00
35.00	.00	.00	.00	.00	.00
40.00	.00	.00	.00	.00	.00
45.00	.00	.00	.00	.00	.00
50.00	.00	.00	.00	.00	.00
55.00	.00	.00	.00	.00	.00
60.00	.00	.00	.00	.00	.00
65.00	.00	.00	.00	.00	.00
70.00	.00	.00	.00	.00	.00
75.00	.00	.00	.00	.00	.00
80.00	.00	.00	.00	.00	.00
85.00	.00	.00	.00	.00	.00
90.00	.00	.00	.00	.00	.00
95.00	.00	.00	.00	.00	.00
100.00	.00	.00	.00	.00	.00
105.00	.00	.00	.00	.00	.00
110.00	.00	.00	.00	.00	.00
115.00	.00	.00	.00	.00	.00
120.00	.00	.00	.00	.00	.00
125.00	.00	.00	.00	.00	.00
130.00	.00	.00	.00	.00	.00
135.00	.00	.00	.00	.00	.00
140.00	.00	.00	.00	.00	.00
145.00	.00	.00	.00	.00	.00
150.00	.00	.00	.00	.00	.00
155.00	.00	.00	.00	.00	.00
160.00	.00	.00	.00	.00	.00

Type.... Read HYG
Name.... 20 MINUTE INFLOW
File.... C:\MY DOCUMENTS\PROJECT1.PPW
Storm... Tag: C100yr

Page 1.06
Event: C100yr

HYDROGRAPH ORDINATES (cfs)
Output Time increment = 1.00 min
Time on left represents time for first value in each row.

Time min					
165.00	.00	.00	.00	.00	.00
170.00	.00	.00	.00	.00	.00
175.00	.00	.00	.00	.00	.00
180.00	.00	.00	.00	.00	.00
185.00	.00	.00	.00	.00	.00
190.00	.00	.00	.00	.00	.00
195.00	.00	.00	.00	.00	.00
200.00	.00	.00	.00	.00	.00
205.00	.00	.00	.00	.00	.00
210.00	.00	.00	.00	.00	.00
215.00	.00	.00	.00	.00	.00
220.00	.00	.00	.00	.00	.00
225.00	.00	.00	.00	.00	.00
230.00	.00	.00	.00	.00	.00
235.00	.00	.00	.00	.00	.00
240.00	.00	.00	.00	.00	.00
245.00	.00	.00	.00	.00	.00
250.00	.00				

S/N: f21101d06a84 Bax Engineering
PondPack Ver: 7.0 (325) Compute Time: 10:54:23 Date: 08-05-2002

File.... C:\MY DOCUMENTS\PROJECT1.PPW
Title... Basin B of Avondale Phase 4

POND VOLUME CALCULATIONS

Planimeter scale: 1.00 ft/in

Elevation (ft)	Planimeter (sq.in)	Area (acres)	A1+A2+sq(A1*A2) (acres)	Volume (cu.ft)	Volume Sum (cu.ft)
495.00	.000	.0000	.0000	0	0
496.00	5300.010	.1217	.1217	1767	1767
498.00	7676.730	.1762	.4443	12904	14670
500.00	10220.100	.2346	.6142	17836	32507
502.00	12922.030	.2966	.7951	23089	55596

POND VOLUME EQUATIONS

* Incremental volume computed by the Conic Method for Reservoir Volumes.

$$\text{Volume} = (1/3) * (\text{EL2}-\text{EL1}) * (\text{Area1} + \text{Area2} + \text{sq.rt.}(\text{Area1}*\text{Area2}))$$

where: EL1, EL2 = Lower and upper elevations of the increment
Area1,Area2 = Areas computed for EL1, EL2, respectively
Volume = Incremental volume between EL1 and EL2

File.... C:\MY DOCUMENTS\PROJECT1.PPW
 Title... Overflow structure 59 of Basin B in Avondale Phase 4

***** COMPOSITE OUTFLOW SUMMARY *****

WS Elev, Total Q		Converge		Notes
Elev. ft	Q cfs	TW Elev ft	Error +/-ft	Contributing Structures
495.00	.00	Free	Outfall	(no Q: AI,OR,SL,CV)
495.20	.00	Free	Outfall	(no Q: AI,OR,SL,CV)
495.40	.39	Free	Outfall	SL,CV (no Q: AI,OR)
495.60	.88	Free	Outfall	SL,CV (no Q: AI,OR)
495.80	1.44	Free	Outfall	SL,CV (no Q: AI,OR)
496.00	2.10	Free	Outfall	SL,CV (no Q: AI,OR)
496.20	2.80	Free	Outfall	SL,CV (no Q: AI,OR)
496.40	3.60	Free	Outfall	SL,CV (no Q: AI,OR)
496.60	4.46	Free	Outfall	SL,CV (no Q: AI,OR)
496.80	5.39	Free	Outfall	SL,CV (no Q: AI,OR)
497.00	7.45	Free	Outfall	OR,CV (no Q: AI,SL)
497.20	8.19	Free	Outfall	OR,CV (no Q: AI,SL)
497.40	8.86	Free	Outfall	OR,CV (no Q: AI,SL)
497.60	9.58	Free	Outfall	OR,CV (no Q: AI,SL)
497.80	10.22	Free	Outfall	OR,CV (no Q: AI,SL)
498.00	10.82	Free	Outfall	OR,CV (no Q: AI,SL)
498.20	11.43	Free	Outfall	OR,CV (no Q: AI,SL)
498.40	12.02	Free	Outfall	OR,CV (no Q: AI,SL)
498.60	12.63	Free	Outfall	OR,CV (no Q: AI,SL)
498.80	13.18	Free	Outfall	OR,CV (no Q: AI,SL)
499.00	13.71	Free	Outfall	OR,CV (no Q: AI,SL)
499.20	14.23	Free	Outfall	OR,CV (no Q: AI,SL)
499.25	14.35	Free	Outfall	OR,CV (no Q: AI,SL)
499.40	16.35	Free	Outfall	AI,OR,CV (no Q: SL)
499.60	21.03	Free	Outfall	AI,OR,CV (no Q: SL)
499.80	27.14	Free	Outfall	AI,OR,CV (no Q: SL)
500.00	34.28	Free	Outfall	AI,OR,CV (no Q: SL)
500.20	47.91	Free	Outfall	AI,CV (no Q: OR,SL)
500.40	53.22	Free	Outfall	AI,CV (no Q: OR,SL)
500.60	53.95	Free	Outfall	AI,CV (no Q: OR,SL)
500.80	55.58	Free	Outfall	AI,CV (no Q: OR,SL)
501.00	57.08	Free	Outfall	AI,CV (no Q: OR,SL)
501.20	57.65	Free	Outfall	AI,CV (no Q: OR,SL)
501.40	59.13	Free	Outfall	AI,CV (no Q: OR,SL)
501.60	60.61	Free	Outfall	AI,CV (no Q: OR,SL)
501.80	62.08	Free	Outfall	AI,CV (no Q: OR,SL)
502.00	62.54	Free	Outfall	AI,CV (no Q: OR,SL)

Type... Pond Routed HYG (total out)
 Name... BASIN B OUT Tag: A15yr
 File... C:\MY DOCUMENTS\PROJECT1.PPW
 Storm... A15yr Tag: A15yr

Page 4.01
 Event: A15yr

POND ROUTED TOTAL OUTFLOW HYG...

HYG file =
 HYG ID = BASIN B OUT
 HYG Tag = A15yr

 Peak Discharge = 12.23 cfs
 Time to Peak = 21.00 min
 HYG Volume = 28904 cu.ft

HYDROGRAPH ORDINATES (cfs)

Output Time increment = 1.00 min
 Time on left represents time for first value in each row.

Time min					
.00	.00	.59	1.42	2.24	3.09
5.00	3.99	4.87	6.10	7.57	8.12
10.00	8.59	9.05	9.51	9.90	10.26
15.00	10.59	10.90	11.21	11.51	11.78
20.00	12.05	12.23	12.22	12.04	11.78
25.00	11.52	11.26	11.00	10.74	10.49
30.00	10.24	9.98	9.72	9.45	9.16
35.00	8.88	8.62	8.37	8.12	7.85
40.00	7.59	7.13	6.47	5.86	5.36
45.00	5.12	4.89	4.67	4.46	4.27
50.00	4.08	3.90	3.73	3.57	3.42
55.00	3.28	3.14	3.01	2.89	2.77
60.00	2.66	2.56	2.47	2.37	2.28
65.00	2.20	2.11	2.02	1.93	1.84
70.00	1.76	1.68	1.60	1.53	1.46
75.00	1.38	1.30	1.22	1.14	1.07
80.00	1.01	.94	.89	.79	.71
85.00	.64	.57	.51	.46	.41
90.00	.34	.27	.21	.17	.13
95.00	.10	.08	.06	.05	.04
100.00	.03	.02	.02	.02	.01
105.00	.01	.01	.01	.00	.00
110.00	.00				

Type.... Pond Routed HYG (total out)
 Name.... BASIN B OUT Tag: B25yr
 File.... C:\MY DOCUMENTS\PROJECT1.PPW
 Storm... B25yr Tag: B25yr

Page 4.02
 Event: B25yr

POND ROUTED TOTAL OUTFLOW HYG...

HYG file =
 HYG ID = BASIN B OUT
 HYG Tag = B25yr

 Peak Discharge = 13.89 cfs
 Time to Peak = 22.00 min
 HYG Volume = 35697 cu.ft

HYDROGRAPH ORDINATES (cfs)

Output Time increment = 1.00 min
 Time on left represents time for first value in each row.

Time min					
.00	.00	.69	1.59	2.55	3.66
5.00	4.81	6.50	7.89	8.56	9.19
10.00	9.78	10.29	10.75	11.19	11.61
15.00	12.01	12.40	12.76	13.08	13.39
20.00	13.68	13.87	13.89	13.74	13.49
25.00	13.25	13.00	12.75	12.49	12.22
30.00	11.95	11.69	11.44	11.17	10.91
35.00	10.65	10.41	10.16	9.89	9.63
40.00	9.35	9.06	8.79	8.54	8.29
45.00	8.03	7.76	7.50	6.90	6.26
50.00	5.67	5.27	5.04	4.81	4.60
55.00	4.39	4.20	4.02	3.84	3.68
60.00	3.52	3.37	3.23	3.10	2.97
65.00	2.84	2.73	2.63	2.53	2.43
70.00	2.34	2.25	2.17	2.08	1.99
75.00	1.90	1.81	1.73	1.65	1.58
80.00	1.51	1.44	1.35	1.27	1.19
85.00	1.12	1.05	.98	.92	.85
90.00	.77	.69	.61	.55	.49
95.00	.44	.40	.31	.25	.19
100.00	.15	.12	.09	.07	.06
105.00	.05	.04	.03	.02	.02
110.00	.01	.01	.01	.01	.01
115.00	.00	.00	.00		

Type.... Pond Routed HYG (total out)
 Name.... BASIN B OUT Tag: C100yr
 File.... C:\MY DOCUMENTS\PROJECT1.PPW
 Storm... C100yr Tag: C100yr

Page 4.03
 Event: C100yr

POND ROUTED TOTAL OUTFLOW HYG...

HYG file =
 HYG ID = BASIN B OUT
 HYG Tag = C100yr

 Peak Discharge = 25.40 cfs
 Time to Peak = 21.00 min
 HYG Volume = 45669 cu.ft

HYDROGRAPH ORDINATES (cfs)

Output Time increment = 1.00 min
 Time on left represents time for first value in each row.

Time min					
.00	.00	.84	1.83	3.03	4.53
5.00	6.73	8.23	9.11	9.93	10.62
10.00	11.26	11.85	12.43	12.94	13.41
15.00	13.84	14.25	15.82	18.51	21.23
20.00	24.10	25.40	24.31	21.25	18.29
25.00	16.01	14.70	14.18	13.94	13.70
30.00	13.45	13.21	12.96	12.71	12.45
35.00	12.18	11.91	11.65	11.39	11.13
40.00	10.87	10.61	10.37	10.11	9.85
45.00	9.59	9.30	9.02	8.75	8.50
50.00	8.25	7.99	7.72	7.46	6.79
55.00	6.16	5.58	5.23	5.00	4.78
60.00	4.56	4.36	4.17	3.99	3.82
65.00	3.65	3.49	3.35	3.21	3.08
70.00	2.95	2.82	2.71	2.61	2.51
75.00	2.42	2.33	2.24	2.15	2.07
80.00	1.97	1.88	1.80	1.72	1.64
85.00	1.57	1.50	1.43	1.34	1.26
90.00	1.18	1.11	1.04	.97	.91
95.00	.84	.75	.67	.60	.54
100.00	.48	.43	.38	.30	.24
105.00	.19	.15	.12	.09	.07
110.00	.06	.04	.03	.03	.02
115.00	.02	.01	.01	.01	.01
120.00	.01	.00	.00	.00	.00

POND7
Routing Calculations
15, 25 and 100 Year 20 Minute Design Storms
Pennial Basin

Table of Contents

***** RUNOFF HYDROGRAPHS *****

CHERRY FLOWS.... A 15YR	
Read HYG	1.01
CHERRY FLOWS.... B 25YR	
Read HYG	1.04
CHERRY FLOWS.... C 100Y	
Read HYG	1.06
HUTCHINGS OUT... Read HYG	1.08
HUTCHINGS OUT... B 25YR	
Read HYG	1.11
HUTCHINGS OUT... C 100Y	
Read HYG	1.14
LEGACY OUTFLOW.. A 15YR	
Read HYG	1.17
LEGACY OUTFLOW.. B 25YR	
Read HYG	1.20
LEGACY OUTFLOW.. C 100Y	
Read HYG	1.22
OFF AREA 2..... A 15YR	
Read HYG	1.25
OFF AREA 2..... B 25YR	
Read HYG	1.28
OFF AREA 2..... C 100Y	
Read HYG	1.31
OFFSITE AREA 3.. A 15YR	
Read HYG	1.34
OFFSITE AREA 3.. B 25YR	
Read HYG	1.37
OFFSITE AREA 3.. C 100Y	
Read HYG	1.40

Table of Contents (continued)

OFFSITE AREA 4.. A 15YR
 Read HYG 1.43

OFFSITE AREA 4.. B 25YR
 Read HYG 1.44

OFFSITE AREA 4.. C 100Y
 Read HYG 1.45

ON-SITE INFLOW.. A 15YR
 Read HYG 1.46

ON-SITE INFLOW.. B 25YR
 Read HYG 1.49

ON-SITE INFLOW.. C 100Y
 Read HYG 1.52

***** POND VOLUMES *****

PENNIAL LAKE.... Vol: Planimeter 2.01

***** OUTLET STRUCTURES *****

TRIPLE BOX W/BOX Outlet Input Data 3.01
 Composite Rating Curve 3.06

***** POND ROUTING *****

PENNIAL LAKE IN A 15YR
 Node: Pond Inflow Summary 4.01

PENNIAL LAKE IN B 25YR
 Node: Pond Inflow Summary 4.05

PENNIAL LAKE IN C 100Y
 Node: Pond Inflow Summary 4.09

Table of Contents (continued)

PENNIAL LAKE OUT A 15YR	
Pond Routing Summary	4.13
Pond Routed HYG (total out)	4.14
PENNIAL LAKE OUT B 25YR	
Pond Routing Summary	4.19
Pond Routed HYG (total out)	4.20
PENNIAL LAKE OUT C 100Y	
Pond Routing Summary	4.25
Pond Routed HYG (total out)	4.26

Type.... Read HYG
 Name.... CHERRY FLOWS
 File.... C:\MY DOCUMENTS\PENNIAL PARK LAKE DETENTION.PPW
 Title... Outflows From Cherrywood Parc lagged by three minutes
 Storm... Tag: A 15YR

HYG file = C:\MY DOCUMENTS\CHRRY 15.HYG
 HYG ID = Cherry Out 15
 HYG Tag = 15yr

 Peak Discharge = 16.08 cfs
 Time to Peak = 38.00 min
 HYG Volume = 76070 cu.ft

HYDROGRAPH ORDINATES (cfs)
 Output Time increment = 1.00 min
 Time on left represents time for first value in each row.

Time min					
.00	.00	.00	.00	.00	.22
5.00	.62	1.14	1.79	2.26	2.73
10.00	3.23	3.72	4.27	4.91	5.61
15.00	6.66	7.82	8.50	9.24	10.15
20.00	10.87	11.45	12.01	12.58	13.12
25.00	13.58	14.01	14.37	14.70	14.98
30.00	15.22	15.44	15.61	15.76	15.88
35.00	15.97	16.04	16.07	16.08	16.07
40.00	16.03	15.96	15.87	15.75	15.62
45.00	15.49	15.36	15.22	15.09	14.95
50.00	14.82	14.69	14.55	14.41	14.27
55.00	14.14	14.00	13.86	13.72	13.58
60.00	13.44	13.31	13.17	13.03	12.89
65.00	12.75	12.61	12.47	12.33	12.19
70.00	12.04	11.90	11.76	11.62	11.48
75.00	11.33	11.19	11.04	10.90	10.76
80.00	10.62	10.42	10.18	9.95	9.72
85.00	9.50	9.28	9.07	8.89	8.73
90.00	8.56	8.40	8.24	8.09	7.94
95.00	7.72	7.45	7.19	6.93	6.69
100.00	6.45	6.22	6.00	5.79	5.62
105.00	5.48	5.35	5.21	5.09	4.96
110.00	4.84	4.72	4.60	4.49	4.38
115.00	4.27	4.17	4.07	3.97	3.88
120.00	3.78	3.69	3.61	3.52	3.44
125.00	3.35	3.27	3.20	3.12	3.05
130.00	2.95	2.86	2.77	2.69	2.61
135.00	2.53	2.45	2.37	2.30	2.23
140.00	2.16	2.09	2.03	1.97	1.84
145.00	1.72	1.61	1.51	1.41	1.32
150.00	1.24	1.16	1.08	1.01	.95
155.00	.89	.83	.77	.71	.64

Type.... Read HYG Page 1.02
 Name.... CHERRY FLOWS Event: A 15YR
 File.... C:\MY DOCUMENTS\PENNIAL PARK LAKE DETENTION.PPW
 Title... Outflows From Cherrywood Parc lagged by three minutes
 Storm... Tag: A 15YR

HYDROGRAPH ORDINATES (cfs)
 Output Time increment = 1.00 min
 Time on left represents time for first value in each row.

Time min					
160.00	.59	.54	.49	.44	.41
165.00	.37	.34	.31	.28	.26
170.00	.23	.21	.19	.18	.15
175.00	.12	.10	.09	.07	.06
180.00	.05	.04	.03	.03	.02
185.00	.02	.02	.01	.01	.01
190.00	.01	.01	.01	.00	.00
195.00	.00	.00	.00	.00	.00
200.00	.00	.00	.00	.00	.00
205.00	.00	.00	.00	.00	.00
210.00	.00	.00	.00	.00	.00
215.00	.00	.00	.00	.00	.00
220.00	.00	.00	.00	.00	.00
225.00	.00	.00	.00	.00	.00
230.00	.00	.00	.00	.00	.00
235.00	.00	.00	.00	.00	.00
240.00	.00	.00	.00	.00	.00
245.00	.00	.00	.00	.00	.00
250.00	.00	.00	.00	.00	.00
255.00	.00	.00	.00	.00	.00
260.00	.00	.00	.00	.00	.00
265.00	.00	.00	.00	.00	.00
270.00	.00	.00	.00	.00	.00
275.00	.00	.00	.00	.00	.00
280.00	.00	.00	.00	.00	.00
285.00	.00	.00	.00	.00	.00
290.00	.00	.00	.00	.00	.00
295.00	.00	.00	.00	.00	.00
300.00	.00	.00	.00	.00	.00
305.00	.00	.00	.00	.00	.00
310.00	.00	.00	.00	.00	.00
315.00	.00	.00	.00	.00	.00
320.00	.00	.00	.00	.00	.00
325.00	.00	.00	.00	.00	.00
330.00	.00	.00	.00	.00	.00
335.00	.00	.00	.00	.00	.00
340.00	.00	.00	.00	.00	.00
345.00	.00	.00	.00	.00	.00
350.00	.00	.00	.00	.00	.00
355.00	.00	.00	.00	.00	.00
360.00	.00	.00	.00	.00	.00
365.00	.00	.00	.00	.00	.00
370.00	.00	.00	.00	.00	.00
375.00	.00	.00	.00	.00	.00
380.00	.00	.00	.00	.00	.00
385.00	.00	.00	.00	.00	.00

Type.... Read HYG
 Name.... CHERRY FLOWS
 File.... C:\MY DOCUMENTS\PENNIAL PARK LAKE DETENTION.PPW
 Title... Outflows From Cherrywood Parc lagged by three minutes
 Storm... Tag: A 15YR

HYDROGRAPH ORDINATES (cfs)
 Output Time increment = 1.00 min
 Time on left represents time for first value in each row.

Time min					
390.00	.00	.00	.00	.00	.00
395.00	.00	.00	.00	.00	.00
400.00	.00	.00	.00	.00	.00
405.00	.00	.00	.00	.00	.00
410.00	.00	.00	.00	.00	.00
415.00	.00	.00	.00	.00	.00
420.00	.00	.00	.00	.00	.00
425.00	.00	.00	.00	.00	.00
430.00	.00	.00	.00	.00	.00
435.00	.00	.00	.00	.00	.00
440.00	.00	.00	.00	.00	.00
445.00	.00	.00	.00	.00	.00
450.00	.00	.00	.00	.00	.00
455.00	.00	.00	.00	.00	.00
460.00	.00	.00	.00	.00	.00
465.00	.00	.00	.00	.00	.00
470.00	.00	.00	.00	.00	.00
475.00	.00	.00	.00	.00	.00
480.00	.00	.00	.00	.00	.00
485.00	.00	.00	.00	.00	.00
490.00	.00	.00	.00	.00	.00
495.00	.00	.00	.00	.00	.00
500.00	.00	.00	.00	.00	.00
505.00	.00	.00	.00	.00	.00
510.00	.00	.00	.00	.00	.00
515.00	.00	.00	.00	.00	.00
520.00	.00	.00	.00	.00	.00
525.00	.00	.00	.00	.00	.00
530.00	.00	.00	.00	.00	.00
535.00	.00	.00	.00	.00	.00
540.00	.00	.00	.00	.00	.00
545.00	.00	.00	.00	.00	.00
550.00	.00	.00	.00	.00	.00
555.00	.00	.00	.00	.00	.00
560.00	.00	.00	.00	.00	.00
565.00	.00	.00	.00	.00	.00
570.00	.00	.00	.00	.00	.00
575.00	.00	.00	.00	.00	.00
580.00	.00	.00	.00	.00	.00
585.00	.00	.00	.00	.00	.00
590.00	.00	.00	.00	.00	.00
595.00	.00	.00	.00	.00	.00
600.00	.00				

Type.... Read HYG
 Name.... CHERRY FLOWS
 File.... C:\MY DOCUMENTS\PENNIAL PARK LAKE DETENTION.PPW
 Storm... Tag: B 25YR

HYG file = C:\MY DOCUMENTS\CHRRY 25.HYG
 HYG ID = Cherry out 25
 HYG Tag = 25yr

 Peak Discharge = 26.79 cfs
 Time to Peak = 36.00 min
 HYG Volume = 94001 cu.ft

HYDROGRAPH ORDINATES (cfs)
 Output Time increment = 1.00 min
 Time on left represents time for first value in each row.

Time min					
.00	.00	.00	.00	.00	.26
5.00	.75	1.34	2.05	2.53	3.10
10.00	3.63	4.24	4.96	5.77	7.03
15.00	8.13	8.90	9.88	10.78	11.43
20.00	12.06	12.70	13.34	13.98	14.57
25.00	15.09	15.56	15.97	16.33	17.83
30.00	19.50	21.82	23.65	25.03	25.99
35.00	26.56	26.79	26.68	26.28	25.59
40.00	24.66	23.49	22.10	20.51	19.08
45.00	18.21	17.38	16.59	16.30	16.17
50.00	16.04	15.91	15.77	15.64	15.51
55.00	15.38	15.24	15.11	14.98	14.84
60.00	14.71	14.57	14.43	14.30	14.16
65.00	14.03	13.89	13.75	13.61	13.47
70.00	13.33	13.20	13.06	12.91	12.77
75.00	12.63	12.49	12.36	12.21	12.07
80.00	11.93	11.78	11.64	11.51	11.36
85.00	11.21	11.07	10.93	10.79	10.65
90.00	10.46	10.22	9.99	9.76	9.54
95.00	9.32	9.11	8.93	8.76	8.59
100.00	8.43	8.27	8.12	7.96	7.78
105.00	7.50	7.23	6.98	6.73	6.49
110.00	6.26	6.04	5.82	5.65	5.51
115.00	5.37	5.24	5.11	4.98	4.86
120.00	4.74	4.62	4.51	4.40	4.29
125.00	4.18	4.09	3.99	3.89	3.80
130.00	3.71	3.62	3.54	3.45	3.37
135.00	3.29	3.21	3.13	3.06	2.97
140.00	2.88	2.79	2.70	2.62	2.54
145.00	2.46	2.39	2.31	2.24	2.17
150.00	2.11	2.04	1.98	1.87	1.75
155.00	1.63	1.53	1.43	1.34	1.25
160.00	1.17	1.10	1.02	.96	.90

Type.... Read HYG
 Name.... CHERRY FLOWS
 File.... C:\MY DOCUMENTS\PENNIAL PARK LAKE DETENTION.PPW
 Storm... Tag: B 25YR

Page 1.05
 Event: B 25YR

HYDROGRAPH ORDINATES (cfs)
 Output Time increment = 1.00 min
 Time on left represents time for first value in each row.

Time min					
165.00	.84	.79	.72	.65	.60
170.00	.54	.50	.45	.41	.38
175.00	.34	.31	.28	.26	.24
180.00	.22	.20	.18	.16	.13
185.00	.11	.09	.07	.06	.05
190.00	.04	.04	.03	.02	.02
195.00	.02	.01	.01	.01	.01
200.00	.01	.00	.00	.00	.00
205.00	.00				

Type.... Read HYG
 Name.... CHERRY FLOWS
 File.... C:\MY DOCUMENTS\PENNIAL PARK LAKE DETENTION.PPW
 Storm... Tag: C 100Y

HYG file = C:\MY DOCUMENTS\CHRRY100.HYG
 HYG ID = Cherry out 100
 HYG Tag = 100yr

 Peak Discharge = 50.13 cfs
 Time to Peak = 34.00 min
 HYG Volume = 133038 cu.ft

HYDROGRAPH ORDINATES (cfs)
 Output Time increment = 1.00 min
 Time on left represents time for first value in each row.

Time min					
.00	.00	.00	.00	.00	.33
5.00	.96	1.79	2.42	3.10	3.75
10.00	4.53	5.45	6.81	8.17	9.12
15.00	10.37	11.22	11.99	12.77	13.54
20.00	14.30	15.06	15.81	17.32	23.00
25.00	29.94	36.73	41.68	45.65	47.31
30.00	48.36	49.15	49.71	50.03	50.13
35.00	50.01	49.69	49.18	48.47	47.57
40.00	46.51	43.92	40.73	37.32	33.58
45.00	30.18	27.13	24.94	22.97	21.16
50.00	19.50	18.54	17.69	16.89	16.35
55.00	16.22	16.09	15.96	15.83	15.69
60.00	15.56	15.43	15.30	15.16	15.03
65.00	14.89	14.76	14.62	14.49	14.35
70.00	14.21	14.08	13.94	13.80	13.66
75.00	13.52	13.39	13.25	13.11	12.97
80.00	12.83	12.69	12.55	12.41	12.27
85.00	12.12	11.98	11.84	11.70	11.56
90.00	11.42	11.27	11.12	10.98	10.84
95.00	10.70	10.56	10.32	10.08	9.85
100.00	9.62	9.40	9.19	8.99	8.82
105.00	8.66	8.49	8.33	8.18	8.02
110.00	7.87	7.60	7.33	7.07	6.82
115.00	6.58	6.35	6.12	5.90	5.70
120.00	5.56	5.42	5.29	5.16	5.03
125.00	4.91	4.78	4.67	4.55	4.44
130.00	4.33	4.22	4.12	4.02	3.93
135.00	3.84	3.74	3.65	3.57	3.48
140.00	3.40	3.32	3.24	3.16	3.09
145.00	3.00	2.91	2.82	2.74	2.65
150.00	2.57	2.49	2.41	2.34	2.27
155.00	2.20	2.13	2.07	2.00	1.91
160.00	1.79	1.68	1.57	1.47	1.37

Type.... Read HYG
Name.... CHERRY FLOWS
File.... C:\MY DOCUMENTS\PENNIAL PARK LAKE DETENTION.PPW
Storm... Tag: C 100Y

Page 1.07
Event: C 100YR

HYDROGRAPH ORDINATES (cfs)
Output Time increment = 1.00 min
Time on left represents time for first value in each row.

Time min					
165.00	1.28	1.20	1.12	1.05	.98
170.00	.92	.86	.81	.74	.68
175.00	.62	.56	.51	.47	.43
180.00	.39	.36	.32	.30	.27
185.00	.25	.22	.20	.19	.17
190.00	.14	.12	.10	.08	.07
195.00	.06	.05	.04	.03	.03
200.00	.02	.02	.02	.01	.01
205.00	.01	.00	.00	.00	.00
210.00	.00				

Type.... Read HYG
 Name.... HUTCHINGS OUT
 File.... C:\MY DOCUMENTS\PENNIAL PARK LAKE DETENTION.PPW
 Title... Outflow hydrographs from Hutchings Farm Lake lagged
 by three minutes
 Storm... Tag: A 15YR

HYG file = C:\MY DOCUMENTS\HUTCH-15.HYG
 HYG ID = 15 Year, Outflow
 HYG Tag = 15YR

 Peak Discharge = 13.75 cfs
 Time to Peak = 40.00 min
 HYG Volume = 152986 cu.ft

HYDROGRAPH ORDINATES (cfs)
 Output Time increment = 2.00 min
 Time on left represents time for first value in each row.

Time min					
.00	.00	.00	.00	.21	.57
10.00	1.11	1.82	2.69	3.71	4.86
20.00	6.15	7.56	9.04	10.32	11.32
30.00	12.09	12.68	13.13	13.45	13.65
40.00	13.75	13.74	13.64	13.53	13.42
50.00	13.30	13.19	13.08	12.97	12.85
60.00	12.74	12.62	12.51	12.40	12.28
70.00	12.17	12.05	11.94	11.82	11.70
80.00	11.59	11.47	11.36	11.24	11.12
90.00	11.01	10.89	10.83	10.71	10.59
100.00	10.47	10.35	10.24	10.12	10.00
110.00	9.88	9.76	9.64	9.52	9.40
120.00	9.29	9.17	9.05	8.94	8.83
130.00	8.72	8.61	8.50	8.39	8.29
140.00	8.18	8.08	7.97	7.87	7.77
150.00	7.67	7.58	7.48	7.38	7.29
160.00	7.19	7.10	7.01	6.92	6.83
170.00	6.74	6.65	6.57	6.48	6.40
180.00	6.31	6.23	6.15	6.07	5.99
190.00	5.95	5.87	5.79	5.75	5.68
200.00	5.60	5.53	5.46	5.38	5.31
210.00	5.24	5.17	5.10	5.03	4.97
220.00	4.90	4.84	4.77	4.71	4.64
230.00	4.58	4.52	4.46	4.40	4.34
240.00	4.28	4.22	4.16	4.11	4.05
250.00	4.00	3.94	3.89	3.84	3.78
260.00	3.73	3.68	3.63	3.58	3.53
270.00	3.48	3.44	3.39	3.34	3.30
280.00	3.25	3.21	3.16	3.12	3.08
290.00	3.03	2.99	2.95	2.91	2.87
300.00	2.83	2.79	2.75	2.71	2.68

Type.... Read HYG Page 1.09
 Name.... HUTCHINGS OUT Event: A 15YR
 File.... C:\MY DOCUMENTS\PENNIAL PARK LAKE DETENTION.PPW
 Title... Outflow hydrographs from Hutchings Farm Lake lagged
 by three minutes
 Storm... Tag: A 15YR

Time min	HYDROGRAPH ORDINATES (cfs)				
	Output Time increment = 2.00 min Time on left represents time for first value in each row.				
310.00	2.64	2.60	2.57	2.53	2.50
320.00	2.46	2.43	2.39	2.36	2.33
330.00	2.29	2.26	2.23	2.20	2.17
340.00	2.14	2.11	2.08	2.05	2.02
350.00	1.99	1.96	1.94	1.91	1.88
360.00	1.86	1.83	1.80	1.78	1.75
370.00	1.73	1.70	1.68	1.66	1.63
380.00	1.61	1.59	1.56	1.54	1.52
390.00	1.50	1.48	1.46	1.44	1.42
400.00	1.40	1.38	1.36	1.34	1.32
410.00	1.30	1.28	1.26	1.24	1.23
420.00	1.21	1.19	1.18	1.16	1.14
430.00	1.13	1.11	1.09	1.08	1.06
440.00	1.05	1.03	1.02	1.00	.99
450.00	.98	.96	.95	.93	.92
460.00	.91	.89	.88	.87	.86
470.00	.84	.83	.82	.78	.77
480.00	.76	.75	.74	.73	.72
490.00	.70	.69	.68	.67	.67
500.00	.66	.65	.64	.63	.62
510.00	.61	.60	.59	.58	.58
520.00	.57	.56	.56	.55	.54
530.00	.54	.53	.52	.51	.51
540.00	.50	.49	.48	.48	.47
550.00	.46	.46	.45	.44	.44
560.00	.43	.42	.42	.42	.41
570.00	.41	.40	.39	.39	.38
580.00	.38	.37	.37	.36	.36
590.00	.35	.35	.34	.34	.33
600.00	.33	.32	.32	.31	.31
610.00	.31	.30	.30	.29	.29
620.00	.28	.28	.27	.27	.26
630.00	.26	.25	.25	.24	.24
640.00	.24	.23	.23	.22	.22
650.00	.21	.21	.20	.20	.19
660.00	.19	.18	.18	.17	.17
670.00	.16	.16	.15	.15	.14
680.00	.14	.13	.13	.12	.12
690.00	.11	.10	.09	.09	.08
700.00	.08	.07	.06	.05	.04
710.00	.03	.02	.01	.01	.01
720.00	.00	.00	.00	.00	.00
730.00	.00	.00	.00	.00	.00
740.00	.00	.00	.00	.00	.00
750.00	.00	.00	.00	.00	.00

S/N: f21101d06a84 Bax Engineering
 PondPack Ver: 7.0 (325) Compute Time: 12:52:05 Date: 08-12-2002

Type.... Read HYG Page 1.10
 Name.... HUTCHINGS OUT Event: A 15YR
 File.... C:\MY DOCUMENTS\PENNIAL PARK LAKE DETENTION.PPW
 Title... Outflow hydrographs from Hutchings Farm Lake lagged
 by three minutes
 Storm... Tag: A 15YR

HYDROGRAPH ORDINATES (cfs)
 Output Time increment = 2.00 min
 Time on left represents time for first value in each row.

Time min						
760.00	.00	.00	.00	.00	.00	.00
770.00	.00	.00	.00	.00	.00	.00
780.00	.00	.00	.00	.00	.00	.00
790.00	.00	.00	.00	.00	.00	.00
800.00	.00					

Type.... Read HYG
 Name.... HUTCHINGS OUT
 File.... C:\MY DOCUMENTS\PENNIAL PARK LAKE DETENTION.PPW
 Storm... Tag: B 25YR

HYG file = C:\MY DOCUMENTS\HUTCH-25.HYG
 HYG ID = 25 Year Outflow
 HYG Tag = 25YR

 Peak Discharge = 15.76 cfs
 Time to Peak = 40.00 min
 HYG Volume = 184685 cu.ft

HYDROGRAPH ORDINATES (cfs)
 Output Time increment = 2.00 min
 Time on left represents time for first value in each row.

Time min	Output Time increment = 2.00 min				
.00	.00	.00	.00	.26	.71
10.00	1.37	2.24	3.30	4.54	5.95
20.00	7.51	9.21	10.90	12.21	13.23
30.00	14.02	14.63	15.10	15.44	15.66
40.00	15.76	15.76	15.67	15.56	15.46
50.00	15.35	15.24	15.13	15.02	14.92
60.00	14.81	14.70	14.59	14.48	14.37
70.00	14.26	14.15	14.04	13.93	13.82
80.00	13.71	13.60	13.48	13.37	13.26
90.00	13.14	13.03	12.92	12.81	12.69
100.00	12.58	12.46	12.35	12.24	12.12
110.00	12.00	11.89	11.77	11.66	11.55
120.00	11.43	11.32	11.20	11.09	10.98
130.00	10.85	10.74	10.63	10.52	10.41
140.00	10.27	10.16	10.05	9.94	9.83
150.00	9.69	9.58	9.47	9.36	9.25
160.00	9.11	9.00	8.89	8.78	8.67
170.00	8.53	8.42	8.31	8.20	8.09
180.00	7.95	7.84	7.73	7.62	7.51
190.00	7.37	7.26	7.15	7.04	6.93
200.00	6.79	6.68	6.57	6.46	6.35
210.00	6.21	6.10	5.99	5.88	5.77
220.00	5.63	5.52	5.41	5.30	5.19
230.00	5.05	4.94	4.83	4.72	4.61
240.00	4.47	4.36	4.25	4.14	4.03
250.00	3.89	3.78	3.67	3.56	3.45
260.00	3.31	3.20	3.09	2.98	2.87
270.00	2.73	2.62	2.51	2.40	2.29
280.00	2.15	2.04	1.93	1.82	1.71
290.00	1.57	1.46	1.35	1.24	1.13
300.00	1.00	0.89	0.78	0.67	0.56
310.00	0.42	0.31	0.20	0.09	0.00
320.00	0.00	0.00	0.00	0.00	0.00

Type.... Read HYG
 Name.... HUTCHINGS OUT
 File.... C:\MY DOCUMENTS\PENNIAL PARK LAKE DETENTION.PPW
 Storm... Tag: B 25YR

HYDROGRAPH ORDINATES (cfs)
 Output Time increment = 2.00 min
 Time on left represents time for first value in each row.

Time min					
330.00	2.83	2.79	2.76	2.72	2.68
340.00	2.64	2.61	2.57	2.53	2.50
350.00	2.46	2.43	2.40	2.36	2.33
360.00	2.30	2.26	2.23	2.20	2.17
370.00	2.14	2.11	2.08	2.05	2.02
380.00	1.99	1.97	1.94	1.91	1.88
390.00	1.86	1.83	1.81	1.78	1.76
400.00	1.73	1.71	1.68	1.66	1.63
410.00	1.61	1.59	1.57	1.54	1.52
420.00	1.50	1.48	1.46	1.44	1.42
430.00	1.40	1.38	1.36	1.34	1.32
440.00	1.30	1.28	1.26	1.25	1.23
450.00	1.21	1.19	1.18	1.16	1.14
460.00	1.13	1.12	1.10	1.09	1.07
470.00	1.06	1.05	1.03	1.02	1.01
480.00	.99	.98	.96	.95	.94
490.00	.92	.91	.90	.88	.87
500.00	.86	.85	.83	.82	.81
510.00	.80	.79	.78	.76	.75
520.00	.74	.73	.72	.71	.70
530.00	.69	.68	.67	.66	.65
540.00	.64	.63	.62	.62	.61
550.00	.60	.59	.58	.57	.56
560.00	.56	.55	.54	.53	.52
570.00	.52	.51	.50	.50	.49
580.00	.48	.47	.47	.46	.46
590.00	.45	.44	.44	.43	.43
600.00	.42	.42	.41	.41	.40
610.00	.40	.39	.39	.38	.38
620.00	.37	.37	.36	.36	.35
630.00	.35	.34	.34	.33	.32
640.00	.32	.31	.31	.30	.30
650.00	.29	.29	.28	.27	.27
660.00	.26	.26	.25	.25	.24
670.00	.24	.23	.23	.22	.22
680.00	.21	.20	.20	.19	.19
690.00	.19	.18	.18	.17	.17
700.00	.16	.16	.15	.15	.14
710.00	.14	.13	.13	.12	.12
720.00	.10	.09	.09	.08	.08
730.00	.07	.07	.06	.06	.05
740.00	.04	.04	.04	.03	.03
750.00	.03	.02	.02	.02	.01
760.00	.01	.01	.00	.00	.00
770.00	.00	.00	.00	.00	.00
780.00	.00	.00	.00	.00	.00
790.00	.00	.00	.00	.00	.00

Type.... Read HYG
Name.... HUTCHINGS OUT
File.... C:\MY DOCUMENTS\PENNIAL PARK LAKE DETENTION.PPW
Storm... Tag: B 25YR

Page 1.13
Event: B 25YR

HYDROGRAPH ORDINATES (cfs)
Output Time increment = 2.00 min
Time on left represents time for first value in each row.

Time min	
800.00	.00

Type... Read HYG
 Name... HUTCHINGS OUT
 File... C:\MY DOCUMENTS\PENNIAL PARK LAKE DETENTION.PPW
 Storm... Tag: C 100Y

HYG file = C:\MY DOCUMENTS\HUTCH100.HYG
 HYG ID = 100 Year Outflow
 HYG Tag = 100YR

 Peak Discharge = 22.54 cfs
 Time to Peak = 40.00 min
 HYG Volume = 239263 cu.ft

HYDROGRAPH ORDINATES (cfs)
 Output Time increment = 2.00 min
 Time on left represents time for first value in each row.

Time min					
.00	.00	.00	.00	.33	.90
10.00	1.75	2.85	4.19	5.75	7.51
20.00	9.46	11.40	13.12	14.47	15.53
30.00	16.36	17.47	19.25	20.86	21.99
40.00	22.54	22.47	21.87	21.25	20.65
50.00	20.10	19.58	19.09	18.66	18.23
60.00	17.87	17.53	17.36	17.10	16.87
70.00	16.66	16.55	16.45	16.35	16.24
80.00	16.19	16.08	15.98	15.87	15.76
90.00	15.66	15.55	15.44	15.34	15.23
100.00	15.12	15.01	14.90	14.79	14.69
110.00	14.58	14.47	14.36	14.25	14.14
120.00	14.03	13.92	13.80	13.69	13.58
130.00	13.47	13.36	13.25	13.13	13.02
140.00	12.91	12.79	12.68	12.57	12.45
150.00	12.34	12.22	12.11	11.99	11.88
160.00	11.76	11.64	11.53	11.41	11.29
170.00	11.18	11.06	10.94	10.82	10.71
180.00	10.59	10.47	10.35	10.23	10.12
190.00	9.99	9.87	9.76	9.64	9.52
200.00	9.40	9.28	9.17	9.05	8.94
210.00	8.83	8.72	8.61	8.50	8.39
220.00	8.28	8.18	8.08	7.97	7.87
230.00	7.77	7.67	7.57	7.48	7.38
240.00	7.28	7.19	7.10	6.78	6.69
250.00	6.61	6.52	6.44	6.35	6.27
260.00	6.19	6.11	6.03	5.95	5.87
270.00	5.79	5.71	5.64	5.56	5.49
280.00	5.42	5.35	5.27	5.20	5.13
290.00	5.07	5.00	4.93	4.87	4.80
300.00	4.74	4.67	4.61	4.55	4.49
310.00	4.43	4.37	4.31	4.25	4.19
320.00	4.13	4.08	4.02	3.97	3.92

Type.... Read HYG
 Name.... HUTCHINGS OUT
 File.... C:\MY DOCUMENTS\PENNIAL PARK LAKE DETENTION.PPW
 Storm... Tag: C 100Y

HYDROGRAPH ORDINATES (cfs)
 Output Time increment = 2.00 min
 Time on left represents time for first value in each row.

Time min					
330.00	3.86	3.81	3.76	3.71	3.66
340.00	3.61	3.56	3.51	3.46	3.41
350.00	3.37	3.32	3.27	3.23	3.18
360.00	3.14	3.10	3.05	3.01	2.97
370.00	2.93	2.89	2.85	2.81	2.77
380.00	2.73	2.69	2.66	2.62	2.58
390.00	2.55	2.51	2.48	2.44	2.41
400.00	2.38	2.34	2.31	2.28	2.24
410.00	2.21	2.18	2.15	2.12	2.09
420.00	2.06	2.03	2.01	1.98	1.95
430.00	1.92	1.90	1.87	1.84	1.82
440.00	1.79	1.77	1.74	1.72	1.69
450.00	1.67	1.64	1.62	1.60	1.58
460.00	1.55	1.53	1.51	1.49	1.47
470.00	1.45	1.43	1.41	1.39	1.37
480.00	1.35	1.33	1.31	1.29	1.27
490.00	1.25	1.24	1.22	1.20	1.18
500.00	1.17	1.15	1.13	1.12	1.10
510.00	1.09	1.07	1.06	1.05	1.03
520.00	1.02	1.00	.99	.98	.96
530.00	.95	.93	.92	.91	.89
540.00	.88	.87	.86	.84	.83
550.00	.82	.81	.80	.79	.77
560.00	.76	.75	.74	.73	.72
570.00	.71	.70	.69	.68	.67
580.00	.66	.65	.64	.63	.62
590.00	.61	.61	.60	.59	.58
600.00	.57	.56	.55	.54	.53
610.00	.52	.51	.50	.49	.49
620.00	.49	.48	.47	.46	.45
630.00	.44	.43	.42	.41	.40
640.00	.39	.38	.37	.36	.35
650.00	.34	.33	.32	.31	.30
660.00	.29	.28	.27	.26	.25
670.00	.24	.23	.22	.21	.20
680.00	.19	.18	.17	.16	.15
690.00	.14	.13	.12	.11	.10
700.00	.09	.08	.07	.06	.05
710.00	.04	.03	.02	.01	.00
720.00	.00	.00	.00	.00	.00
730.00	.00	.00	.00	.00	.00
740.00	.00	.00	.00	.00	.00
750.00	.00	.00	.00	.00	.00
760.00	.00	.00	.00	.00	.00
770.00	.00	.00	.00	.00	.00
780.00	.00	.00	.00	.00	.00
790.00	.00	.00	.00	.00	.00

Type... Read HYG
Name... HUTCHINGS OUT
File... C:\MY DOCUMENTS\PENNIAL PARK LAKE DETENTION.PPW
Storm... Tag: C 100Y

Page 1.16
Event: C 100YR

HYDROGRAPH ORDINATES (cfs)
Output Time increment = 2.00 min
Time on left represents time for first value in each row.

Time min	
800.00	.00

Type.... Read HYG
 Name.... LEGACY OUTFLOW
 File.... C:\MY DOCUMENTS\PENNIAL PARK LAKE DETENTION.PPW
 Storm... Tag: A 15YR

HYG file = C:\MY DOCUMENTS\LGCY 15.HYG
 HYG ID = LEGACY 15 yr OUT
 HYG Tag = 15YR

 Peak Discharge = 56.93 cfs
 Time to Peak = 26.00 min
 HYG Volume = 83643 cu.ft

HYDROGRAPH ORDINATES (cfs)
 Output Time increment = 1.00 min
 Time on left represents time for first value in each row.

Time min					
.00	.00	.00	.00	.00	.00
5.00	.00	.07	.26	.71	1.53
10.00	2.73	4.30	6.25	8.65	11.29
15.00	13.94	16.56	19.12	21.62	24.03
20.00	26.35	29.23	35.18	42.39	48.47
25.00	53.96	56.93	56.91	54.67	50.76
30.00	45.93	40.75	35.11	30.62	27.49
35.00	26.09	24.78	23.53	22.36	21.25
40.00	20.21	19.22	18.29	17.41	16.58
45.00	15.80	15.06	14.36	13.70	13.07
50.00	12.48	11.92	11.39	10.88	10.41
55.00	9.96	9.53	9.12	8.74	8.38
60.00	8.04	7.70	7.39	7.10	6.82
65.00	6.55	6.29	6.04	5.81	5.60
70.00	5.39	5.19	5.00	4.81	4.63
75.00	4.46	4.31	4.16	4.01	3.87
80.00	3.73	3.60	3.48	3.35	3.24
85.00	3.13	3.02	2.92	2.83	2.73
90.00	2.64	2.55	2.47	2.39	2.31
95.00	2.23	2.16	2.09	2.02	1.96
100.00	1.90	1.84	1.79	1.73	1.68
105.00	1.63	1.58	1.53	1.49	1.44
110.00	1.40	1.36	1.32	1.28	1.24
115.00	1.20	1.16	1.13	1.10	1.07
120.00	1.05	1.02	.99	.97	.95
125.00	.92	.90	.88	.85	.83
130.00	.81	.79	.77	.75	.73
135.00	.71	.70	.68	.66	.64
140.00	.63	.61	.60	.58	.57
145.00	.55	.54	.53	.51	.50
150.00	.49	.47	.46	.45	.44
155.00	.43	.42	.41	.40	.39
160.00	.39	.38	.38	.37	.36

Type... Read HYG
 Name... LEGACY OUTFLOW
 File... C:\MY DOCUMENTS\PENNIAL PARK LAKE DETENTION.PPW
 Storm... Tag: A 15YR

HYDROGRAPH ORDINATES (cfs)
 Output Time increment = 1.00 min
 Time on left represents time for first value in each row.

Time min					
165.00	.36	.35	.35	.34	.34
170.00	.33	.33	.32	.32	.31
175.00	.31	.30	.30	.29	.29
180.00	.29	.28	.28	.27	.27
185.00	.27	.26	.26	.26	.25
190.00	.25	.25	.24	.24	.23
195.00	.23	.23	.22	.22	.22
200.00	.21	.21	.21	.21	.20
205.00	.20	.20	.19	.19	.19
210.00	.18	.18	.18	.18	.17
215.00	.17	.17	.17	.16	.16
220.00	.16	.16	.16	.15	.15
225.00	.15	.15	.15	.15	.14
230.00	.14	.14	.14	.14	.14
235.00	.13	.13	.13	.13	.13
240.00	.13	.12	.12	.12	.12
245.00	.12	.12	.11	.11	.11
250.00	.11	.11	.10	.10	.10
255.00	.10	.10	.00	.00	.00
260.00	.00	.00	.00	.00	.00
265.00	.00	.00	.00	.00	.00
270.00	.00	.00	.00	.00	.00
275.00	.00	.00	.00	.00	.00
280.00	.00	.00	.00	.00	.00
285.00	.00	.00	.00	.00	.00
290.00	.00	.00	.00	.00	.00
295.00	.00	.00	.00	.00	.00
300.00	.00	.00	.00	.00	.00
305.00	.00	.00	.00	.00	.00
310.00	.00	.00	.00	.00	.00
315.00	.00	.00	.00	.00	.00
320.00	.00	.00	.00	.00	.00
325.00	.00	.00	.00	.00	.00
330.00	.00	.00	.00	.00	.00
335.00	.00	.00	.00	.00	.00
340.00	.00	.00	.00	.00	.00
345.00	.00	.00	.00	.00	.00
350.00	.00	.00	.00	.00	.00
355.00	.00	.00	.00	.00	.00
360.00	.00	.00	.00	.00	.00
365.00	.00	.00	.00	.00	.00
370.00	.00	.00	.00	.00	.00
375.00	.00	.00	.00	.00	.00
380.00	.00	.00	.00	.00	.00
385.00	.00	.00	.00	.00	.00
390.00	.00	.00	.00	.00	.00
395.00	.00	.00	.00	.00	.00

Type.... Read HYG
 Name.... LEGACY OUTFLOW
 File.... C:\MY DOCUMENTS\PENNIAL PARK LAKE DETENTION.PPW
 Storm... Tag: A 15YR

HYDROGRAPH ORDINATES (cfs)
 Output Time increment = 1.00 min
 Time on left represents time for first value in each row.

Time min					
400.00	.00	.00	.00	.00	.00
405.00	.00	.00	.00	.00	.00
410.00	.00	.00	.00	.00	.00
415.00	.00	.00	.00	.00	.00
420.00	.00	.00	.00	.00	.00
425.00	.00	.00	.00	.00	.00
430.00	.00	.00	.00	.00	.00
435.00	.00	.00	.00	.00	.00
440.00	.00	.00	.00	.00	.00
445.00	.00	.00	.00	.00	.00
450.00	.00	.00	.00	.00	.00
455.00	.00	.00	.00	.00	.00
460.00	.00	.00	.00	.00	.00
465.00	.00	.00	.00	.00	.00
470.00	.00	.00	.00	.00	.00
475.00	.00	.00	.00	.00	.00
480.00	.00	.00	.00	.00	.00
485.00	.00	.00	.00	.00	.00
490.00	.00	.00	.00	.00	.00
495.00	.00	.00	.00	.00	.00
500.00	.00	.00	.00	.00	.00
505.00	.00	.00	.00	.00	.00
510.00	.00	.00	.00	.00	.00
515.00	.00	.00	.00	.00	.00
520.00	.00	.00	.00	.00	.00
525.00	.00	.00	.00	.00	.00
530.00	.00	.00	.00	.00	.00
535.00	.00	.00	.00	.00	.00
540.00	.00	.00	.00	.00	.00
545.00	.00	.00	.00	.00	.00
550.00	.00	.00	.00	.00	.00
555.00	.00	.00	.00	.00	.00
560.00	.00	.00	.00	.00	.00
565.00	.00	.00	.00	.00	.00
570.00	.00	.00	.00	.00	.00
575.00	.00	.00	.00	.00	.00
580.00	.00	.00	.00	.00	.00
585.00	.00	.00	.00	.00	.00
590.00	.00	.00	.00	.00	.00
595.00	.00	.00	.00	.00	.00
600.00	.00	.00	.00	.00	.00

Type.... Read HYG
 Name.... LEGACY OUTFLOW
 File.... C:\MY DOCUMENTS\PENNIAL PARK LAKE DETENTION.PPW
 Storm... Tag: B 25YR

HYG file = C:\MY DOCUMENTS\LGCY 25.HYG
 HYG ID = Legacy 25 yr out
 HYG Tag = 25YR

 Peak Discharge = 78.87 cfs
 Time to Peak = 46.00 min
 HYG Volume = 206673 cu.ft

HYDROGRAPH ORDINATES (cfs)
 Output Time increment = 2.00 min
 Time on left represents time for first value in each row.

Time min					
.00	.00	.00	.00	.08	.32
10.00	.94	2.02	3.58	5.60	8.15
20.00	11.27	14.67	18.08	21.41	24.65
30.00	27.78	35.54	46.38	56.37	64.21
40.00	70.38	74.83	78.05	78.87	76.47
50.00	71.72	65.30	58.03	50.11	42.42
60.00	34.87	29.78	27.24	25.86	24.56
70.00	23.32	22.16	21.06	20.03	19.05
80.00	18.13	17.26	16.44	15.67	14.93
90.00	14.24	13.59	12.96	12.38	11.83
100.00	11.30	10.80	10.33	9.89	9.46
110.00	9.05	8.68	8.32	7.98	7.65
120.00	7.34	7.05	6.77	6.50	6.25
130.00	6.00	5.77	5.56	5.35	5.15
140.00	4.96	4.78	4.60	4.44	4.28
150.00	4.13	3.98	3.84	3.71	3.58
160.00	3.45	3.33	3.22	3.11	3.01
170.00	2.91	2.81	2.72	2.63	2.54
180.00	2.45	2.37	2.29	2.22	2.14
190.00	2.07	2.01	1.95	1.89	1.83
200.00	1.78	1.73	1.67	1.62	1.57
210.00	1.53	1.48	1.44	1.39	1.35
220.00	1.31	1.27	1.23	1.19	1.16
230.00	1.13	1.10	1.07	1.04	1.02
240.00	.99	.97	.94	.92	.89
250.00	.87	.85	.83	.81	.79
260.00	.77	.75	.73	.71	.69
270.00	.67	.66	.64	.63	.61
280.00	.59	.58	.56	.55	.54
290.00	.52	.51	.50	.48	.47
300.00	.46	.45	.44	.43	.42
310.00	.40	.40	.39	.39	.38
320.00	.37	.37	.36	.36	.35

Type.... Read HYG
 Name.... LEGACY OUTFLOW
 File.... C:\MY DOCUMENTS\PENNIAL PARK LAKE DETENTION.PPW
 Storm... Tag: B 25YR

HYDROGRAPH ORDINATES (cfs)
 Output Time increment = 2.00 min
 Time on left represents time for first value in each row.

Time min					
330.00	.35	.34	.34	.33	.33
340.00	.32	.32	.31	.31	.30
350.00	.30	.29	.29	.29	.28
360.00	.28	.27	.27	.26	.26
370.00	.26	.25	.25	.25	.24
380.00	.24	.23	.23	.23	.22
390.00	.22	.22	.21	.21	.21
400.00	.20	.20	.20	.20	.19
410.00	.19	.19	.18	.18	.18
420.00	.18	.17	.17	.17	.17
430.00	.16	.16	.16	.16	.15
440.00	.15	.15	.15	.14	.14
450.00	.14	.14	.14	.13	.13
460.00	.13	.13	.13	.12	.12
470.00	.12	.12	.12	.12	.11
480.00	.11	.11	.11	.11	.11
490.00	.10	.10	.10	.10	.10
500.00	.00	.00	.00	.00	.00
510.00	.00	.00	.00	.00	.00
520.00	.00	.00	.00	.00	.00
530.00	.00	.00	.00	.00	.00
540.00	.00	.00	.00	.00	.00
550.00	.00	.00	.00	.00	.00
560.00	.00	.00	.00	.00	.00
570.00	.00	.00	.00	.00	.00
580.00	.00	.00	.00	.00	.00
590.00	.00	.00	.00	.00	.00
600.00	.00	.00	.00	.00	.00

Type.... Read HYG
 Name.... LEGACY OUTFLOW
 File.... C:\MY DOCUMENTS\PENNIAL PARK LAKE DETENTION.PPW
 Storm... Tag: C 100Y

HYG file = C:\MY DOCUMENTS\LGCY 100.HYG
 HYG ID = LGCY 100 Yr Out
 HYG Tag = 100YR

 Peak Discharge = 105.11 cfs
 Time to Peak = 25.00 min
 HYG Volume = 132259 cu.ft

HYDROGRAPH ORDINATES (cfs)						
Time min	Output Time increment = 1.00 min					
	Time on left represents time for first value in each row.					
.00	.00	.00	.00	.00	.00	.00
5.00	.00	.10	.42	1.31	2.80	
10.00	4.88	7.62	11.11	15.32	19.89	
15.00	24.38	29.75	44.29	60.59	74.33	
20.00	84.39	91.64	96.82	100.47	103.15	
25.00	105.11	104.72	100.76	94.12	85.26	
30.00	75.02	63.76	52.65	42.01	33.87	
35.00	28.92	26.99	25.62	24.33	23.11	
40.00	21.96	20.87	19.85	18.88	17.97	
45.00	17.11	16.30	15.53	14.80	14.12	
50.00	13.47	12.85	12.28	11.73	11.21	
55.00	10.71	10.25	9.81	9.39	8.99	
60.00	8.61	8.26	7.92	7.59	7.28	
65.00	7.00	6.72	6.46	6.20	5.96	
70.00	5.73	5.52	5.32	5.12	4.93	
75.00	4.75	4.57	4.41	4.25	4.10	
80.00	3.96	3.82	3.69	3.56	3.43	
85.00	3.31	3.20	3.09	2.99	2.89	
90.00	2.79	2.70	2.61	2.52	2.44	
95.00	2.36	2.28	2.20	2.13	2.06	
100.00	2.00	1.94	1.88	1.82	1.77	
105.00	1.72	1.66	1.61	1.56	1.52	
110.00	1.47	1.43	1.38	1.34	1.30	
115.00	1.26	1.22	1.19	1.15	1.12	
120.00	1.09	1.06	1.04	1.01	.99	
125.00	.96	.94	.91	.89	.87	
130.00	.85	.82	.80	.78	.76	
135.00	.74	.73	.71	.69	.67	
140.00	.65	.64	.62	.61	.59	
145.00	.58	.56	.55	.53	.52	
150.00	.51	.49	.48	.47	.46	
155.00	.45	.44	.42	.41	.40	
160.00	.40	.39	.38	.38	.37	

Type.... Read HYG
 Name.... LEGACY OUTFLOW
 File.... C:\MY DOCUMENTS\PENNIAL PARK LAKE DETENTION.PPW
 Storm... Tag: C 100Y

HYDROGRAPH ORDINATES (cfs)
 Output Time increment = 1.00 min
 Time on left represents time for first value in each row.

Time min					
165.00	.37	.36	.36	.35	.35
170.00	.34	.34	.33	.33	.32
175.00	.32	.31	.31	.30	.30
180.00	.29	.29	.28	.28	.28
185.00	.27	.27	.26	.26	.26
190.00	.25	.25	.24	.24	.24
195.00	.23	.23	.23	.22	.22
200.00	.22	.21	.21	.21	.20
205.00	.20	.20	.19	.19	.19
210.00	.19	.18	.18	.18	.18
215.00	.17	.17	.17	.17	.16
220.00	.16	.16	.16	.15	.15
225.00	.15	.15	.14	.14	.14
230.00	.14	.14	.13	.13	.13
235.00	.13	.13	.12	.12	.12
240.00	.12	.12	.11	.11	.11
245.00	.11	.11	.11	.10	.10
250.00	.10	.10	.10	.00	.00
255.00	.00	.00	.00	.00	.00
260.00	.00	.00	.00	.00	.00
265.00	.00	.00	.00	.00	.00
270.00	.00	.00	.00	.00	.00
275.00	.00	.00	.00	.00	.00
280.00	.00	.00	.00	.00	.00
285.00	.00	.00	.00	.00	.00
290.00	.00	.00	.00	.00	.00
295.00	.00	.00	.00	.00	.00
300.00	.00	.00	.00	.00	.00
305.00	.00	.00	.00	.00	.00
310.00	.00	.00	.00	.00	.00
315.00	.00	.00	.00	.00	.00
320.00	.00	.00	.00	.00	.00
325.00	.00	.00	.00	.00	.00
330.00	.00	.00	.00	.00	.00
335.00	.00	.00	.00	.00	.00
340.00	.00	.00	.00	.00	.00
345.00	.00	.00	.00	.00	.00
350.00	.00	.00	.00	.00	.00
355.00	.00	.00	.00	.00	.00
360.00	.00	.00	.00	.00	.00
365.00	.00	.00	.00	.00	.00
370.00	.00	.00	.00	.00	.00
375.00	.00	.00	.00	.00	.00
380.00	.00	.00	.00	.00	.00
385.00	.00	.00	.00	.00	.00
390.00	.00	.00	.00	.00	.00
395.00	.00	.00	.00	.00	.00

Type.... Read HYG
 Name.... LEGACY OUTFLOW
 File.... C:\MY DOCUMENTS\PENNIAL PARK LAKE DETENTION.PPW
 Storm... Tag: C 100Y

HYDROGRAPH ORDINATES (cfs)
 Output Time increment = 1.00 min
 Time on left represents time for first value in each row.

Time min					
400.00	.00	.00	.00	.00	.00
405.00	.00	.00	.00	.00	.00
410.00	.00	.00	.00	.00	.00
415.00	.00	.00	.00	.00	.00
420.00	.00	.00	.00	.00	.00
425.00	.00	.00	.00	.00	.00
430.00	.00	.00	.00	.00	.00
435.00	.00	.00	.00	.00	.00
440.00	.00	.00	.00	.00	.00
445.00	.00	.00	.00	.00	.00
450.00	.00	.00	.00	.00	.00
455.00	.00	.00	.00	.00	.00
460.00	.00	.00	.00	.00	.00
465.00	.00	.00	.00	.00	.00
470.00	.00	.00	.00	.00	.00
475.00	.00	.00	.00	.00	.00
480.00	.00	.00	.00	.00	.00
485.00	.00	.00	.00	.00	.00
490.00	.00	.00	.00	.00	.00
495.00	.00	.00	.00	.00	.00
500.00	.00	.00	.00	.00	.00
505.00	.00	.00	.00	.00	.00
510.00	.00	.00	.00	.00	.00
515.00	.00	.00	.00	.00	.00
520.00	.00	.00	.00	.00	.00
525.00	.00	.00	.00	.00	.00
530.00	.00	.00	.00	.00	.00
535.00	.00	.00	.00	.00	.00
540.00	.00	.00	.00	.00	.00
545.00	.00	.00	.00	.00	.00
550.00	.00	.00	.00	.00	.00
555.00	.00	.00	.00	.00	.00
560.00	.00	.00	.00	.00	.00
565.00	.00	.00	.00	.00	.00
570.00	.00	.00	.00	.00	.00
575.00	.00	.00	.00	.00	.00
580.00	.00	.00	.00	.00	.00
585.00	.00	.00	.00	.00	.00
590.00	.00	.00	.00	.00	.00
595.00	.00	.00	.00	.00	.00
600.00	.00	.00	.00	.00	.00

Type.... Read HYG Page 1.25
 Name.... OFF AREA 2 Event: A 15YR
 File.... C:\MY DOCUMENTS\PENNIAL PARK LAKE DETENTION.PPW
 Title... Offsite inflow from Hutchings Farm and Cherrywood Parc
 Storm... Tag: A 15YR

HYG file = C:\MY DOCUMENTS\OFF2-15.HYG
 HYG ID = Hutch offsite 2
 HYG Tag = 15yr

 Peak Discharge = 6.31 cfs
 Time to Peak = 7.00 min
 HYG Volume = 7568 cu.ft

HYDROGRAPH ORDINATES (cfs)
 Output Time increment = 1.00 min
 Time on left represents time for first value in each row.

Time min					
.00	.00	.90	1.80	2.70	3.60
5.00	4.50	5.40	6.31	6.31	6.31
10.00	6.31	6.31	6.31	6.31	6.31
15.00	6.31	6.31	6.31	6.31	6.31
20.00	6.31	5.40	4.50	3.60	2.70
25.00	1.80	.90	.00	.00	.00
30.00	.00	.00	.00	.00	.00
35.00	.00	.00	.00	.00	.00
40.00	.00	.00	.00	.00	.00
45.00	.00	.00	.00	.00	.00
50.00	.00	.00	.00	.00	.00
55.00	.00	.00	.00	.00	.00
60.00	.00	.00	.00	.00	.00
65.00	.00	.00	.00	.00	.00
70.00	.00	.00	.00	.00	.00
75.00	.00	.00	.00	.00	.00
80.00	.00	.00	.00	.00	.00
85.00	.00	.00	.00	.00	.00
90.00	.00	.00	.00	.00	.00
95.00	.00	.00	.00	.00	.00
100.00	.00	.00	.00	.00	.00
105.00	.00	.00	.00	.00	.00
110.00	.00	.00	.00	.00	.00
115.00	.00	.00	.00	.00	.00
120.00	.00	.00	.00	.00	.00
125.00	.00	.00	.00	.00	.00
130.00	.00	.00	.00	.00	.00
135.00	.00	.00	.00	.00	.00
140.00	.00	.00	.00	.00	.00
145.00	.00	.00	.00	.00	.00
150.00	.00	.00	.00	.00	.00
155.00	.00	.00	.00	.00	.00

Type.... Read HYG Page 1.26
 Name.... OFF AREA 2 Event: A 15YR
 File.... C:\MY DOCUMENTS\PENNIAL PARK LAKE DETENTION.PPW
 Title... Offsite inflow from Hutchings Farm and Cherrywood Parc
 Storm... Tag: A 15YR

HYDROGRAPH ORDINATES (cfs)
 Output Time increment = 1.00 min
 Time on left represents time for first value in each row.

Time min					
160.00	.00	.00	.00	.00	.00
165.00	.00	.00	.00	.00	.00
170.00	.00	.00	.00	.00	.00
175.00	.00	.00	.00	.00	.00
180.00	.00	.00	.00	.00	.00
185.00	.00	.00	.00	.00	.00
190.00	.00	.00	.00	.00	.00
195.00	.00	.00	.00	.00	.00
200.00	.00	.00	.00	.00	.00
205.00	.00	.00	.00	.00	.00
210.00	.00	.00	.00	.00	.00
215.00	.00	.00	.00	.00	.00
220.00	.00	.00	.00	.00	.00
225.00	.00	.00	.00	.00	.00
230.00	.00	.00	.00	.00	.00
235.00	.00	.00	.00	.00	.00
240.00	.00	.00	.00	.00	.00
245.00	.00	.00	.00	.00	.00
250.00	.00	.00	.00	.00	.00
255.00	.00	.00	.00	.00	.00
260.00	.00	.00	.00	.00	.00
265.00	.00	.00	.00	.00	.00
270.00	.00	.00	.00	.00	.00
275.00	.00	.00	.00	.00	.00
280.00	.00	.00	.00	.00	.00
285.00	.00	.00	.00	.00	.00
290.00	.00	.00	.00	.00	.00
295.00	.00	.00	.00	.00	.00
300.00	.00	.00	.00	.00	.00
305.00	.00	.00	.00	.00	.00
310.00	.00	.00	.00	.00	.00
315.00	.00	.00	.00	.00	.00
320.00	.00	.00	.00	.00	.00
325.00	.00	.00	.00	.00	.00
330.00	.00	.00	.00	.00	.00
335.00	.00	.00	.00	.00	.00
340.00	.00	.00	.00	.00	.00
345.00	.00	.00	.00	.00	.00
350.00	.00	.00	.00	.00	.00
355.00	.00	.00	.00	.00	.00
360.00	.00	.00	.00	.00	.00
365.00	.00	.00	.00	.00	.00
370.00	.00	.00	.00	.00	.00
375.00	.00	.00	.00	.00	.00
380.00	.00	.00	.00	.00	.00
385.00	.00	.00	.00	.00	.00

Type.... Read HYG Page 1.27
 Name.... OFF AREA 2 Event: A 15YR
 File.... C:\MY DOCUMENTS\PENNIAL PARK LAKE DETENTION.PPW
 Title... Offsite inflow from Hutchings Farm and Cherrywood Parc
 Storm... Tag: A 15YR

HYDROGRAPH ORDINATES (cfs)
 Output Time increment = 1.00 min
 Time on left represents time for first value in each row.

Time min					
390.00	.00	.00	.00	.00	.00
395.00	.00	.00	.00	.00	.00
400.00	.00	.00	.00	.00	.00
405.00	.00	.00	.00	.00	.00
410.00	.00	.00	.00	.00	.00
415.00	.00	.00	.00	.00	.00
420.00	.00	.00	.00	.00	.00
425.00	.00	.00	.00	.00	.00
430.00	.00	.00	.00	.00	.00
435.00	.00	.00	.00	.00	.00
440.00	.00	.00	.00	.00	.00
445.00	.00	.00	.00	.00	.00
450.00	.00	.00	.00	.00	.00
455.00	.00	.00	.00	.00	.00
460.00	.00	.00	.00	.00	.00
465.00	.00	.00	.00	.00	.00
470.00	.00	.00	.00	.00	.00
475.00	.00	.00	.00	.00	.00
480.00	.00	.00	.00	.00	.00
485.00	.00	.00	.00	.00	.00
490.00	.00	.00	.00	.00	.00
495.00	.00	.00	.00	.00	.00
500.00	.00	.00	.00	.00	.00
505.00	.00	.00	.00	.00	.00
510.00	.00	.00	.00	.00	.00
515.00	.00	.00	.00	.00	.00
520.00	.00	.00	.00	.00	.00
525.00	.00	.00	.00	.00	.00
530.00	.00	.00	.00	.00	.00
535.00	.00	.00	.00	.00	.00
540.00	.00	.00	.00	.00	.00
545.00	.00	.00	.00	.00	.00
550.00	.00	.00	.00	.00	.00
555.00	.00	.00	.00	.00	.00
560.00	.00	.00	.00	.00	.00
565.00	.00	.00	.00	.00	.00
570.00	.00	.00	.00	.00	.00
575.00	.00	.00	.00	.00	.00
580.00	.00	.00	.00	.00	.00
585.00	.00	.00	.00	.00	.00
590.00	.00	.00	.00	.00	.00
595.00	.00	.00	.00	.00	.00
600.00	.00	.00	.00	.00	.00

Type.... Read HYG
 Name.... OFF AREA 2
 File.... C:\MY DOCUMENTS\PENNIAL PARK LAKE DETENTION.PPW
 Storm... Tag: B 25YR

HYG file = C:\MY DOCUMENTS\OFF2-25.HYG
 HYG ID = Hutch off 2
 HYG Tag = 25yr

 Peak Discharge = 7.79 cfs
 Time to Peak = 7.00 min
 HYG Volume = 9347 cu.ft

HYDROGRAPH ORDINATES (cfs)
 Output Time increment = 1.00 min
 Time on left represents time for first value in each row.

Time min					
.00	.00	1.11	2.22	3.34	4.45
5.00	5.56	6.68	7.79	7.79	7.79
10.00	7.79	7.79	7.79	7.79	7.79
15.00	7.79	7.79	7.79	7.79	7.79
20.00	7.79	6.68	5.56	4.45	3.34
25.00	2.22	1.11	.00	.00	.00
30.00	.00	.00	.00	.00	.00
35.00	.00	.00	.00	.00	.00
40.00	.00	.00	.00	.00	.00
45.00	.00	.00	.00	.00	.00
50.00	.00	.00	.00	.00	.00
55.00	.00	.00	.00	.00	.00
60.00	.00	.00	.00	.00	.00
65.00	.00	.00	.00	.00	.00
70.00	.00	.00	.00	.00	.00
75.00	.00	.00	.00	.00	.00
80.00	.00	.00	.00	.00	.00
85.00	.00	.00	.00	.00	.00
90.00	.00	.00	.00	.00	.00
95.00	.00	.00	.00	.00	.00
100.00	.00	.00	.00	.00	.00
105.00	.00	.00	.00	.00	.00
110.00	.00	.00	.00	.00	.00
115.00	.00	.00	.00	.00	.00
120.00	.00	.00	.00	.00	.00
125.00	.00	.00	.00	.00	.00
130.00	.00	.00	.00	.00	.00
135.00	.00	.00	.00	.00	.00
140.00	.00	.00	.00	.00	.00
145.00	.00	.00	.00	.00	.00
150.00	.00	.00	.00	.00	.00
155.00	.00	.00	.00	.00	.00
160.00	.00	.00	.00	.00	.00

Type.... Read HYG
 Name.... OFF AREA 2
 File.... C:\MY DOCUMENTS\PENNIAL PARK LAKE DETENTION.PPW
 Storm... Tag: B 25YR

HYDROGRAPH ORDINATES (cfs)
 Output Time increment = 1.00 min
 Time on left represents time for first value in each row.

Time min						
165.00	.00	.00	.00	.00	.00	.00
170.00	.00	.00	.00	.00	.00	.00
175.00	.00	.00	.00	.00	.00	.00
180.00	.00	.00	.00	.00	.00	.00
185.00	.00	.00	.00	.00	.00	.00
190.00	.00	.00	.00	.00	.00	.00
195.00	.00	.00	.00	.00	.00	.00
200.00	.00	.00	.00	.00	.00	.00
205.00	.00	.00	.00	.00	.00	.00
210.00	.00	.00	.00	.00	.00	.00
215.00	.00	.00	.00	.00	.00	.00
220.00	.00	.00	.00	.00	.00	.00
225.00	.00	.00	.00	.00	.00	.00
230.00	.00	.00	.00	.00	.00	.00
235.00	.00	.00	.00	.00	.00	.00
240.00	.00	.00	.00	.00	.00	.00
245.00	.00	.00	.00	.00	.00	.00
250.00	.00	.00	.00	.00	.00	.00
255.00	.00	.00	.00	.00	.00	.00
260.00	.00	.00	.00	.00	.00	.00
265.00	.00	.00	.00	.00	.00	.00
270.00	.00	.00	.00	.00	.00	.00
275.00	.00	.00	.00	.00	.00	.00
280.00	.00	.00	.00	.00	.00	.00
285.00	.00	.00	.00	.00	.00	.00
290.00	.00	.00	.00	.00	.00	.00
295.00	.00	.00	.00	.00	.00	.00
300.00	.00	.00	.00	.00	.00	.00
305.00	.00	.00	.00	.00	.00	.00
310.00	.00	.00	.00	.00	.00	.00
315.00	.00	.00	.00	.00	.00	.00
320.00	.00	.00	.00	.00	.00	.00
325.00	.00	.00	.00	.00	.00	.00
330.00	.00	.00	.00	.00	.00	.00
335.00	.00	.00	.00	.00	.00	.00
340.00	.00	.00	.00	.00	.00	.00
345.00	.00	.00	.00	.00	.00	.00
350.00	.00	.00	.00	.00	.00	.00
355.00	.00	.00	.00	.00	.00	.00
360.00	.00	.00	.00	.00	.00	.00
365.00	.00	.00	.00	.00	.00	.00
370.00	.00	.00	.00	.00	.00	.00
375.00	.00	.00	.00	.00	.00	.00
380.00	.00	.00	.00	.00	.00	.00
385.00	.00	.00	.00	.00	.00	.00
390.00	.00	.00	.00	.00	.00	.00
395.00	.00	.00	.00	.00	.00	.00

Type.... Read HYG
 Name.... OFF AREA 2
 File.... C:\MY DOCUMENTS\PENNIAL PARK LAKE DETENTION.PPW
 Storm... Tag: B 25YR

HYDROGRAPH ORDINATES (cfs)
 Output Time increment = 1.00 min
 Time on left represents time for first value in each row.

Time min					
400.00	.00	.00	.00	.00	.00
405.00	.00	.00	.00	.00	.00
410.00	.00	.00	.00	.00	.00
415.00	.00	.00	.00	.00	.00
420.00	.00	.00	.00	.00	.00
425.00	.00	.00	.00	.00	.00
430.00	.00	.00	.00	.00	.00
435.00	.00	.00	.00	.00	.00
440.00	.00	.00	.00	.00	.00
445.00	.00	.00	.00	.00	.00
450.00	.00	.00	.00	.00	.00
455.00	.00	.00	.00	.00	.00
460.00	.00	.00	.00	.00	.00
465.00	.00	.00	.00	.00	.00
470.00	.00	.00	.00	.00	.00
475.00	.00	.00	.00	.00	.00
480.00	.00	.00	.00	.00	.00
485.00	.00	.00	.00	.00	.00
490.00	.00	.00	.00	.00	.00
495.00	.00	.00	.00	.00	.00
500.00	.00	.00	.00	.00	.00
505.00	.00	.00	.00	.00	.00
510.00	.00	.00	.00	.00	.00
515.00	.00	.00	.00	.00	.00
520.00	.00	.00	.00	.00	.00
525.00	.00	.00	.00	.00	.00
530.00	.00	.00	.00	.00	.00
535.00	.00	.00	.00	.00	.00
540.00	.00	.00	.00	.00	.00
545.00	.00	.00	.00	.00	.00
550.00	.00	.00	.00	.00	.00
555.00	.00	.00	.00	.00	.00
560.00	.00	.00	.00	.00	.00
565.00	.00	.00	.00	.00	.00
570.00	.00	.00	.00	.00	.00
575.00	.00	.00	.00	.00	.00
580.00	.00	.00	.00	.00	.00
585.00	.00	.00	.00	.00	.00
590.00	.00	.00	.00	.00	.00
595.00	.00	.00	.00	.00	.00
600.00	.00	.00	.00	.00	.00

Type.... Read HYG
 Name.... OFF AREA 2
 File.... C:\MY DOCUMENTS\PENNIAL PARK LAKE DETENTION.PPW
 Storm... Tag: C 100Y

HYG file = C:\MY DOCUMENTS\OFF2-100.HYG
 HYG ID = Hutch off 2
 HYG Tag = 100yr

 Peak Discharge = 9.96 cfs
 Time to Peak = 7.00 min
 HYG Volume = 11952 cu.ft

HYDROGRAPH ORDINATES (cfs)
 Output Time increment = 1.00 min
 Time on left represents time for first value in each row.

Time min					
.00	.00	1.42	2.85	4.27	5.69
5.00	7.11	8.54	9.96	9.96	9.96
10.00	9.96	9.96	9.96	9.96	9.96
15.00	9.96	9.96	9.96	9.96	9.96
20.00	9.96	8.54	7.11	5.69	4.27
25.00	2.85	1.42	.00	.00	.00
30.00	.00	.00	.00	.00	.00
35.00	.00	.00	.00	.00	.00
40.00	.00	.00	.00	.00	.00
45.00	.00	.00	.00	.00	.00
50.00	.00	.00	.00	.00	.00
55.00	.00	.00	.00	.00	.00
60.00	.00	.00	.00	.00	.00
65.00	.00	.00	.00	.00	.00
70.00	.00	.00	.00	.00	.00
75.00	.00	.00	.00	.00	.00
80.00	.00	.00	.00	.00	.00
85.00	.00	.00	.00	.00	.00
90.00	.00	.00	.00	.00	.00
95.00	.00	.00	.00	.00	.00
100.00	.00	.00	.00	.00	.00
105.00	.00	.00	.00	.00	.00
110.00	.00	.00	.00	.00	.00
115.00	.00	.00	.00	.00	.00
120.00	.00	.00	.00	.00	.00
125.00	.00	.00	.00	.00	.00
130.00	.00	.00	.00	.00	.00
135.00	.00	.00	.00	.00	.00
140.00	.00	.00	.00	.00	.00
145.00	.00	.00	.00	.00	.00
150.00	.00	.00	.00	.00	.00
155.00	.00	.00	.00	.00	.00
160.00	.00	.00	.00	.00	.00

Type.... Read HYG
 Name.... OFF AREA 2
 File.... C:\MY DOCUMENTS\PENNIAL PARK LAKE DETENTION.PPW
 Storm... Tag: C 100Y

HYDROGRAPH ORDINATES (cfs)
 Output Time increment = 1.00 min
 Time on left represents time for first value in each row.

Time min					
165.00	.00	.00	.00	.00	.00
170.00	.00	.00	.00	.00	.00
175.00	.00	.00	.00	.00	.00
180.00	.00	.00	.00	.00	.00
185.00	.00	.00	.00	.00	.00
190.00	.00	.00	.00	.00	.00
195.00	.00	.00	.00	.00	.00
200.00	.00	.00	.00	.00	.00
205.00	.00	.00	.00	.00	.00
210.00	.00	.00	.00	.00	.00
215.00	.00	.00	.00	.00	.00
220.00	.00	.00	.00	.00	.00
225.00	.00	.00	.00	.00	.00
230.00	.00	.00	.00	.00	.00
235.00	.00	.00	.00	.00	.00
240.00	.00	.00	.00	.00	.00
245.00	.00	.00	.00	.00	.00
250.00	.00	.00	.00	.00	.00
255.00	.00	.00	.00	.00	.00
260.00	.00	.00	.00	.00	.00
265.00	.00	.00	.00	.00	.00
270.00	.00	.00	.00	.00	.00
275.00	.00	.00	.00	.00	.00
280.00	.00	.00	.00	.00	.00
285.00	.00	.00	.00	.00	.00
290.00	.00	.00	.00	.00	.00
295.00	.00	.00	.00	.00	.00
300.00	.00	.00	.00	.00	.00
305.00	.00	.00	.00	.00	.00
310.00	.00	.00	.00	.00	.00
315.00	.00	.00	.00	.00	.00
320.00	.00	.00	.00	.00	.00
325.00	.00	.00	.00	.00	.00
330.00	.00	.00	.00	.00	.00
335.00	.00	.00	.00	.00	.00
340.00	.00	.00	.00	.00	.00
345.00	.00	.00	.00	.00	.00
350.00	.00	.00	.00	.00	.00
355.00	.00	.00	.00	.00	.00
360.00	.00	.00	.00	.00	.00
365.00	.00	.00	.00	.00	.00
370.00	.00	.00	.00	.00	.00
375.00	.00	.00	.00	.00	.00
380.00	.00	.00	.00	.00	.00
385.00	.00	.00	.00	.00	.00
390.00	.00	.00	.00	.00	.00
395.00	.00	.00	.00	.00	.00

Type.... Read HYG
 Name.... OFF AREA 2
 File.... C:\MY DOCUMENTS\PENNIAL PARK LAKE DETENTION.PPW
 Storm... Tag: C 100Y

HYDROGRAPH ORDINATES (cfs)
 Output Time increment = 1.00 min
 Time on left represents time for first value in each row.

Time min					
400.00	.00	.00	.00	.00	.00
405.00	.00	.00	.00	.00	.00
410.00	.00	.00	.00	.00	.00
415.00	.00	.00	.00	.00	.00
420.00	.00	.00	.00	.00	.00
425.00	.00	.00	.00	.00	.00
430.00	.00	.00	.00	.00	.00
435.00	.00	.00	.00	.00	.00
440.00	.00	.00	.00	.00	.00
445.00	.00	.00	.00	.00	.00
450.00	.00	.00	.00	.00	.00
455.00	.00	.00	.00	.00	.00
460.00	.00	.00	.00	.00	.00
465.00	.00	.00	.00	.00	.00
470.00	.00	.00	.00	.00	.00
475.00	.00	.00	.00	.00	.00
480.00	.00	.00	.00	.00	.00
485.00	.00	.00	.00	.00	.00
490.00	.00	.00	.00	.00	.00
495.00	.00	.00	.00	.00	.00
500.00	.00	.00	.00	.00	.00
505.00	.00	.00	.00	.00	.00
510.00	.00	.00	.00	.00	.00
515.00	.00	.00	.00	.00	.00
520.00	.00	.00	.00	.00	.00
525.00	.00	.00	.00	.00	.00
530.00	.00	.00	.00	.00	.00
535.00	.00	.00	.00	.00	.00
540.00	.00	.00	.00	.00	.00
545.00	.00	.00	.00	.00	.00
550.00	.00	.00	.00	.00	.00
555.00	.00	.00	.00	.00	.00
560.00	.00	.00	.00	.00	.00
565.00	.00	.00	.00	.00	.00
570.00	.00	.00	.00	.00	.00
575.00	.00	.00	.00	.00	.00
580.00	.00	.00	.00	.00	.00
585.00	.00	.00	.00	.00	.00
590.00	.00	.00	.00	.00	.00
595.00	.00	.00	.00	.00	.00
600.00	.00				

Type.... Read HYG
 Name.... OFFSITE AREA 3
 File.... C:\MY DOCUMENTS\PENNIAL PARK LAKE DETENTION.PPW
 Title... Offsite Area 3 Hydrographs
 Storm... Tag: A 15YR

HYG file = C:\MY DOCUMENTS\OFF3-15.HYG
 HYG ID = Off Area 3-15yr
 HYG Tag = 15YR

 Peak Discharge = 46.30 cfs
 Time to Peak = 9.00 min
 HYG Volume = 55674 cu.ft

HYDROGRAPH ORDINATES (cfs)
 Output Time increment = 1.00 min
 Time on left represents time for first value in each row.

Time min					
.00	.00	5.14	10.29	15.43	20.57
5.00	25.97	31.11	36.25	41.39	46.30
10.00	46.30	46.30	46.30	46.30	46.30
15.00	46.30	46.30	46.30	46.30	46.30
20.00	46.30	41.39	36.25	31.11	25.97
25.00	20.57	15.43	10.29	5.14	.00
30.00	.00	.00	.00	.00	.00
35.00	.00	.00	.00	.00	.00
40.00	.00	.00	.00	.00	.00
45.00	.00	.00	.00	.00	.00
50.00	.00	.00	.00	.00	.00
55.00	.00	.00	.00	.00	.00
60.00	.00	.00	.00	.00	.00
65.00	.00	.00	.00	.00	.00
70.00	.00	.00	.00	.00	.00
75.00	.00	.00	.00	.00	.00
80.00	.00	.00	.00	.00	.00
85.00	.00	.00	.00	.00	.00
90.00	.00	.00	.00	.00	.00
95.00	.00	.00	.00	.00	.00
100.00	.00	.00	.00	.00	.00
105.00	.00	.00	.00	.00	.00
110.00	.00	.00	.00	.00	.00
115.00	.00	.00	.00	.00	.00
120.00	.00	.00	.00	.00	.00
125.00	.00	.00	.00	.00	.00
130.00	.00	.00	.00	.00	.00
135.00	.00	.00	.00	.00	.00
140.00	.00	.00	.00	.00	.00
145.00	.00	.00	.00	.00	.00
150.00	.00	.00	.00	.00	.00
155.00	.00	.00	.00	.00	.00

Type.... Read HYG
 Name.... OFFSITE AREA 3
 File.... C:\MY DOCUMENTS\PENNIAL PARK LAKE DETENTION.PPW
 Title... Offsite Area 3 Hydrographs
 Storm... Tag: A 15YR

HYDROGRAPH ORDINATES (cfs)
 Output Time increment = 1.00 min
 Time on left represents time for first value in each row.

Time min					
160.00	.00	.00	.00	.00	.00
165.00	.00	.00	.00	.00	.00
170.00	.00	.00	.00	.00	.00
175.00	.00	.00	.00	.00	.00
180.00	.00	.00	.00	.00	.00
185.00	.00	.00	.00	.00	.00
190.00	.00	.00	.00	.00	.00
195.00	.00	.00	.00	.00	.00
200.00	.00	.00	.00	.00	.00
205.00	.00	.00	.00	.00	.00
210.00	.00	.00	.00	.00	.00
215.00	.00	.00	.00	.00	.00
220.00	.00	.00	.00	.00	.00
225.00	.00	.00	.00	.00	.00
230.00	.00	.00	.00	.00	.00
235.00	.00	.00	.00	.00	.00
240.00	.00	.00	.00	.00	.00
245.00	.00	.00	.00	.00	.00
250.00	.00	.00	.00	.00	.00
255.00	.00	.00	.00	.00	.00
260.00	.00	.00	.00	.00	.00
265.00	.00	.00	.00	.00	.00
270.00	.00	.00	.00	.00	.00
275.00	.00	.00	.00	.00	.00
280.00	.00	.00	.00	.00	.00
285.00	.00	.00	.00	.00	.00
290.00	.00	.00	.00	.00	.00
295.00	.00	.00	.00	.00	.00
300.00	.00	.00	.00	.00	.00
305.00	.00	.00	.00	.00	.00
310.00	.00	.00	.00	.00	.00
315.00	.00	.00	.00	.00	.00
320.00	.00	.00	.00	.00	.00
325.00	.00	.00	.00	.00	.00
330.00	.00	.00	.00	.00	.00
335.00	.00	.00	.00	.00	.00
340.00	.00	.00	.00	.00	.00
345.00	.00	.00	.00	.00	.00
350.00	.00	.00	.00	.00	.00
355.00	.00	.00	.00	.00	.00
360.00	.00	.00	.00	.00	.00
365.00	.00	.00	.00	.00	.00
370.00	.00	.00	.00	.00	.00
375.00	.00	.00	.00	.00	.00
380.00	.00	.00	.00	.00	.00
385.00	.00	.00	.00	.00	.00

Type.... Read HYG
 Name.... OFFSITE AREA 3
 File.... C:\MY DOCUMENTS\PENNIAL PARK LAKE DETENTION.PPW
 Title... Offsite Area 3 Hydrographs
 Storm... Tag: A 15YR

HYDROGRAPH ORDINATES (cfs)
 Output Time increment = 1.00 min
 Time on left represents time for first value in each row.

Time min					
390.00	.00	.00	.00	.00	.00
395.00	.00	.00	.00	.00	.00
400.00	.00	.00	.00	.00	.00
405.00	.00	.00	.00	.00	.00
410.00	.00	.00	.00	.00	.00
415.00	.00	.00	.00	.00	.00
420.00	.00	.00	.00	.00	.00
425.00	.00	.00	.00	.00	.00
430.00	.00	.00	.00	.00	.00
435.00	.00	.00	.00	.00	.00
440.00	.00	.00	.00	.00	.00
445.00	.00	.00	.00	.00	.00
450.00	.00	.00	.00	.00	.00
455.00	.00	.00	.00	.00	.00
460.00	.00	.00	.00	.00	.00
465.00	.00	.00	.00	.00	.00
470.00	.00	.00	.00	.00	.00
475.00	.00	.00	.00	.00	.00
480.00	.00	.00	.00	.00	.00
485.00	.00	.00	.00	.00	.00
490.00	.00	.00	.00	.00	.00
495.00	.00	.00	.00	.00	.00
500.00	.00	.00	.00	.00	.00
505.00	.00	.00	.00	.00	.00
510.00	.00	.00	.00	.00	.00
515.00	.00	.00	.00	.00	.00
520.00	.00	.00	.00	.00	.00
525.00	.00	.00	.00	.00	.00
530.00	.00	.00	.00	.00	.00
535.00	.00	.00	.00	.00	.00
540.00	.00	.00	.00	.00	.00
545.00	.00	.00	.00	.00	.00
550.00	.00	.00	.00	.00	.00
555.00	.00	.00	.00	.00	.00
560.00	.00	.00	.00	.00	.00
565.00	.00	.00	.00	.00	.00
570.00	.00	.00	.00	.00	.00
575.00	.00	.00	.00	.00	.00
580.00	.00	.00	.00	.00	.00
585.00	.00	.00	.00	.00	.00
590.00	.00	.00	.00	.00	.00
595.00	.00	.00	.00	.00	.00
600.00	.00	.00	.00	.00	.00

Type.... Read HYG
 Name.... OFFSITE AREA 3
 File.... C:\MY DOCUMENTS\PENNIAL PARK LAKE DETENTION.PPW
 Storm... Tag: B 25YR

HYG file = C:\MY DOCUMENTS\OFF3-25.HYG
 HYG ID = Off Area 3-25yr
 HYG Tag = 25YR

 Peak Discharge = 57.18 cfs
 Time to Peak = 9.00 min
 HYG Volume = 68608 cu.ft

HYDROGRAPH ORDINATES (cfs)
 Output Time increment = 1.00 min
 Time on left represents time for first value in each row.

Time min					
.00	.00	6.35	12.71	19.05	25.41
5.00	31.76	38.11	44.45	50.81	57.18
10.00	57.18	57.18	57.18	57.18	57.18
15.00	57.18	57.18	57.18	57.18	57.18
20.00	57.18	50.81	44.45	38.11	31.76
25.00	25.41	19.05	12.71	6.35	.00
30.00	.00	.00	.00	.00	.00
35.00	.00	.00	.00	.00	.00
40.00	.00	.00	.00	.00	.00
45.00	.00	.00	.00	.00	.00
50.00	.00	.00	.00	.00	.00
55.00	.00	.00	.00	.00	.00
60.00	.00	.00	.00	.00	.00
65.00	.00	.00	.00	.00	.00
70.00	.00	.00	.00	.00	.00
75.00	.00	.00	.00	.00	.00
80.00	.00	.00	.00	.00	.00
85.00	.00	.00	.00	.00	.00
90.00	.00	.00	.00	.00	.00
95.00	.00	.00	.00	.00	.00
100.00	.00	.00	.00	.00	.00
105.00	.00	.00	.00	.00	.00
110.00	.00	.00	.00	.00	.00
115.00	.00	.00	.00	.00	.00
120.00	.00	.00	.00	.00	.00
125.00	.00	.00	.00	.00	.00
130.00	.00	.00	.00	.00	.00
135.00	.00	.00	.00	.00	.00
140.00	.00	.00	.00	.00	.00
145.00	.00	.00	.00	.00	.00
150.00	.00	.00	.00	.00	.00
155.00	.00	.00	.00	.00	.00
160.00	.00	.00	.00	.00	.00

Type.... Read HYG
 Name.... OFFSITE AREA 3
 File.... C:\MY DOCUMENTS\PENNIAL PARK LAKE DETENTION.PPW
 Storm... Tag: B 25YR

HYDROGRAPH ORDINATES (cfs)
 Output Time increment = 1.00 min
 Time on left represents time for first value in each row.

Time min					
165.00	.00	.00	.00	.00	.00
170.00	.00	.00	.00	.00	.00
175.00	.00	.00	.00	.00	.00
180.00	.00	.00	.00	.00	.00
185.00	.00	.00	.00	.00	.00
190.00	.00	.00	.00	.00	.00
195.00	.00	.00	.00	.00	.00
200.00	.00	.00	.00	.00	.00
205.00	.00	.00	.00	.00	.00
210.00	.00	.00	.00	.00	.00
215.00	.00	.00	.00	.00	.00
220.00	.00	.00	.00	.00	.00
225.00	.00	.00	.00	.00	.00
230.00	.00	.00	.00	.00	.00
235.00	.00	.00	.00	.00	.00
240.00	.00	.00	.00	.00	.00
245.00	.00	.00	.00	.00	.00
250.00	.00	.00	.00	.00	.00
255.00	.00	.00	.00	.00	.00
260.00	.00	.00	.00	.00	.00
265.00	.00	.00	.00	.00	.00
270.00	.00	.00	.00	.00	.00
275.00	.00	.00	.00	.00	.00
280.00	.00	.00	.00	.00	.00
285.00	.00	.00	.00	.00	.00
290.00	.00	.00	.00	.00	.00
295.00	.00	.00	.00	.00	.00
300.00	.00	.00	.00	.00	.00
305.00	.00	.00	.00	.00	.00
310.00	.00	.00	.00	.00	.00
315.00	.00	.00	.00	.00	.00
320.00	.00	.00	.00	.00	.00
325.00	.00	.00	.00	.00	.00
330.00	.00	.00	.00	.00	.00
335.00	.00	.00	.00	.00	.00
340.00	.00	.00	.00	.00	.00
345.00	.00	.00	.00	.00	.00
350.00	.00	.00	.00	.00	.00
355.00	.00	.00	.00	.00	.00
360.00	.00	.00	.00	.00	.00
365.00	.00	.00	.00	.00	.00
370.00	.00	.00	.00	.00	.00
375.00	.00	.00	.00	.00	.00
380.00	.00	.00	.00	.00	.00
385.00	.00	.00	.00	.00	.00
390.00	.00	.00	.00	.00	.00
395.00	.00	.00	.00	.00	.00

Type.... Read HYG
 Name.... OFFSITE AREA 3
 File.... C:\MY DOCUMENTS\PENNIAL PARK LAKE DETENTION.PPW
 Storm... Tag: B 25YR

HYDROGRAPH ORDINATES (cfs)
 Output Time increment = 1.00 min
 Time on left represents time for first value in each row.

Time min					
400.00	.00	.00	.00	.00	.00
405.00	.00	.00	.00	.00	.00
410.00	.00	.00	.00	.00	.00
415.00	.00	.00	.00	.00	.00
420.00	.00	.00	.00	.00	.00
425.00	.00	.00	.00	.00	.00
430.00	.00	.00	.00	.00	.00
435.00	.00	.00	.00	.00	.00
440.00	.00	.00	.00	.00	.00
445.00	.00	.00	.00	.00	.00
450.00	.00	.00	.00	.00	.00
455.00	.00	.00	.00	.00	.00
460.00	.00	.00	.00	.00	.00
465.00	.00	.00	.00	.00	.00
470.00	.00	.00	.00	.00	.00
475.00	.00	.00	.00	.00	.00
480.00	.00	.00	.00	.00	.00
485.00	.00	.00	.00	.00	.00
490.00	.00	.00	.00	.00	.00
495.00	.00	.00	.00	.00	.00
500.00	.00	.00	.00	.00	.00
505.00	.00	.00	.00	.00	.00
510.00	.00	.00	.00	.00	.00
515.00	.00	.00	.00	.00	.00
520.00	.00	.00	.00	.00	.00
525.00	.00	.00	.00	.00	.00
530.00	.00	.00	.00	.00	.00
535.00	.00	.00	.00	.00	.00
540.00	.00	.00	.00	.00	.00
545.00	.00	.00	.00	.00	.00
550.00	.00	.00	.00	.00	.00
555.00	.00	.00	.00	.00	.00
560.00	.00	.00	.00	.00	.00
565.00	.00	.00	.00	.00	.00
570.00	.00	.00	.00	.00	.00
575.00	.00	.00	.00	.00	.00
580.00	.00	.00	.00	.00	.00
585.00	.00	.00	.00	.00	.00
590.00	.00	.00	.00	.00	.00
595.00	.00	.00	.00	.00	.00
600.00	.00				

Type.... Read HYG
 Name.... OFFSITE AREA 3
 File.... C:\MY DOCUMENTS\PENNIAL PARK LAKE DETENTION.PPW
 Storm... Tag: C 100Y

HYG file = C:\MY DOCUMENTS\OFF3-100.HYG
 HYG ID = Off Area 3-100yr
 HYG Tag = 100YR

 Peak Discharge = 73.14 cfs
 Time to Peak = 9.00 min
 HYG Volume = 87774 cu.ft

HYDROGRAPH ORDINATES (cfs)
 Output Time increment = 1.00 min
 Time on left represents time for first value in each row.

Time min					
.00	.00	8.13	16.25	24.38	32.51
5.00	40.64	48.77	56.90	65.03	73.14
10.00	73.14	73.14	73.14	73.14	73.14
15.00	73.14	73.14	73.14	73.14	73.14
20.00	73.14	65.03	56.90	48.77	40.64
25.00	32.51	24.38	16.25	8.13	.00
30.00	.00	.00	.00	.00	.00
35.00	.00	.00	.00	.00	.00
40.00	.00	.00	.00	.00	.00
45.00	.00	.00	.00	.00	.00
50.00	.00	.00	.00	.00	.00
55.00	.00	.00	.00	.00	.00
60.00	.00	.00	.00	.00	.00
65.00	.00	.00	.00	.00	.00
70.00	.00	.00	.00	.00	.00
75.00	.00	.00	.00	.00	.00
80.00	.00	.00	.00	.00	.00
85.00	.00	.00	.00	.00	.00
90.00	.00	.00	.00	.00	.00
95.00	.00	.00	.00	.00	.00
100.00	.00	.00	.00	.00	.00
105.00	.00	.00	.00	.00	.00
110.00	.00	.00	.00	.00	.00
115.00	.00	.00	.00	.00	.00
120.00	.00	.00	.00	.00	.00
125.00	.00	.00	.00	.00	.00
130.00	.00	.00	.00	.00	.00
135.00	.00	.00	.00	.00	.00
140.00	.00	.00	.00	.00	.00
145.00	.00	.00	.00	.00	.00
150.00	.00	.00	.00	.00	.00
155.00	.00	.00	.00	.00	.00
160.00	.00	.00	.00	.00	.00

Type.... Read HYG
 Name.... OFFSITE AREA 3
 File.... C:\MY DOCUMENTS\PENNIAL PARK LAKE DETENTION.PPW
 Storm... Tag: C 100Y

HYDROGRAPH ORDINATES (cfs)
 Output Time increment = 1.00 min
 Time on left represents time for first value in each row.

Time min					
165.00	.00	.00	.00	.00	.00
170.00	.00	.00	.00	.00	.00
175.00	.00	.00	.00	.00	.00
180.00	.00	.00	.00	.00	.00
185.00	.00	.00	.00	.00	.00
190.00	.00	.00	.00	.00	.00
195.00	.00	.00	.00	.00	.00
200.00	.00	.00	.00	.00	.00
205.00	.00	.00	.00	.00	.00
210.00	.00	.00	.00	.00	.00
215.00	.00	.00	.00	.00	.00
220.00	.00	.00	.00	.00	.00
225.00	.00	.00	.00	.00	.00
230.00	.00	.00	.00	.00	.00
235.00	.00	.00	.00	.00	.00
240.00	.00	.00	.00	.00	.00
245.00	.00	.00	.00	.00	.00
250.00	.00	.00	.00	.00	.00
255.00	.00	.00	.00	.00	.00
260.00	.00	.00	.00	.00	.00
265.00	.00	.00	.00	.00	.00
270.00	.00	.00	.00	.00	.00
275.00	.00	.00	.00	.00	.00
280.00	.00	.00	.00	.00	.00
285.00	.00	.00	.00	.00	.00
290.00	.00	.00	.00	.00	.00
295.00	.00	.00	.00	.00	.00
300.00	.00	.00	.00	.00	.00
305.00	.00	.00	.00	.00	.00
310.00	.00	.00	.00	.00	.00
315.00	.00	.00	.00	.00	.00
320.00	.00	.00	.00	.00	.00
325.00	.00	.00	.00	.00	.00
330.00	.00	.00	.00	.00	.00
335.00	.00	.00	.00	.00	.00
340.00	.00	.00	.00	.00	.00
345.00	.00	.00	.00	.00	.00
350.00	.00	.00	.00	.00	.00
355.00	.00	.00	.00	.00	.00
360.00	.00	.00	.00	.00	.00
365.00	.00	.00	.00	.00	.00
370.00	.00	.00	.00	.00	.00
375.00	.00	.00	.00	.00	.00
380.00	.00	.00	.00	.00	.00
385.00	.00	.00	.00	.00	.00
390.00	.00	.00	.00	.00	.00
395.00	.00	.00	.00	.00	.00

HYDROGRAPH ORDINATES (cfs)
 Output Time increment = 1.00 min
 Time on left represents time for first value in each row.

Time min					
400.00	.00	.00	.00	.00	.00
405.00	.00	.00	.00	.00	.00
410.00	.00	.00	.00	.00	.00
415.00	.00	.00	.00	.00	.00
420.00	.00	.00	.00	.00	.00
425.00	.00	.00	.00	.00	.00
430.00	.00	.00	.00	.00	.00
435.00	.00	.00	.00	.00	.00
440.00	.00	.00	.00	.00	.00
445.00	.00	.00	.00	.00	.00
450.00	.00	.00	.00	.00	.00
455.00	.00	.00	.00	.00	.00
460.00	.00	.00	.00	.00	.00
465.00	.00	.00	.00	.00	.00
470.00	.00	.00	.00	.00	.00
475.00	.00	.00	.00	.00	.00
480.00	.00	.00	.00	.00	.00
485.00	.00	.00	.00	.00	.00
490.00	.00	.00	.00	.00	.00
495.00	.00	.00	.00	.00	.00
500.00	.00	.00	.00	.00	.00
505.00	.00	.00	.00	.00	.00
510.00	.00	.00	.00	.00	.00
515.00	.00	.00	.00	.00	.00
520.00	.00	.00	.00	.00	.00
525.00	.00	.00	.00	.00	.00
530.00	.00	.00	.00	.00	.00
535.00	.00	.00	.00	.00	.00
540.00	.00	.00	.00	.00	.00
545.00	.00	.00	.00	.00	.00
550.00	.00	.00	.00	.00	.00
555.00	.00	.00	.00	.00	.00
560.00	.00	.00	.00	.00	.00
565.00	.00	.00	.00	.00	.00
570.00	.00	.00	.00	.00	.00
575.00	.00	.00	.00	.00	.00
580.00	.00	.00	.00	.00	.00
585.00	.00	.00	.00	.00	.00
590.00	.00	.00	.00	.00	.00
595.00	.00	.00	.00	.00	.00
600.00	.00	.00	.00	.00	.00

Type.... Read HYG
 Name.... OFFSITE AREA 4 Tag: A 15YR
 File.... C:\MY DOCUMENTS\PENNIAL PARK LAKE DETENTION.PPW
 Title... Offsite Area 4 Flows to Retention Lake
 Storm... Tag: A 15YR

HYG file = C:\MY DOCUMENTS\OFF4-15.HYG
 HYG ID = Offsite 4 15yr
 HYG Tag = 15YR

 Peak Discharge = 40.39 cfs
 Time to Peak = 10.00 min
 HYG Volume = 48468 cu.ft

HYDROGRAPH ORDINATES (cfs)
 Output Time increment = 10.00 min
 Time on left represents time for first value in each row.

Time min					
.00	.00	40.39	40.39	.00	.00
50.00	.00	.00	.00	.00	.00
100.00	.00	.00	.00	.00	.00
150.00	.00	.00	.00	.00	.00
200.00	.00	.00	.00	.00	.00
250.00	.00				

Type.... Read HYG
 Name.... OFFSITE AREA 4
 File.... C:\MY DOCUMENTS\PENNIAL PARK LAKE DETENTION.PPW
 Storm... Tag: B 25YR

Page 1.44
 Event: B 25YR

HYG file = C:\MY DOCUMENTS\OFF4-25.HYG
 HYG ID = Offsite 4 25yr
 HYG Tag = 25YR

 Peak Discharge = 49.88 cfs
 Time to Peak = 10.00 min
 HYG Volume = 59856 cu.ft

HYDROGRAPH ORDINATES (cfs)
 Output Time increment = 10.00 min
 Time on left represents time for first value in each row.

Time min					
.00	.00	49.88	49.88	.00	.00
50.00	.00	.00	.00	.00	.00
100.00	.00	.00	.00	.00	.00
150.00	.00	.00	.00	.00	.00
200.00	.00	.00	.00	.00	.00
250.00	.00				

Type... Read HYG
 Name... OFFSITE AREA 4
 File... C:\MY DOCUMENTS\PENNIAL PARK LAKE DETENTION.PPW
 Storm... Tag: C 100Y

HYG file = C:\MY DOCUMENTS\OFF4-100.HYG
 HYG ID = Offsite 4 100yr
 HYG Tag = 100YR

 Peak Discharge = 63.80 cfs
 Time to Peak = 10.00 min
 HYG Volume = 76560 cu.ft

HYDROGRAPH ORDINATES (cfs)
 Output Time increment = 10.00 min
 Time on left represents time for first value in each row.

Time min					
.00	.00	63.80	63.80	.00	.00
50.00	.00	.00	.00	.00	.00
100.00	.00	.00	.00	.00	.00
150.00	.00	.00	.00	.00	.00
200.00	.00	.00	.00	.00	.00
250.00	.00				

Type.... Read HYG
 Name.... ON-SITE INFLOW
 File.... C:\MY DOCUMENTS\PENNIAL PARK LAKE DETENTION.PPW
 Title... 20 Minute Duration Design Storms
 Storm... Tag: A 15YR

HYG file = C:\MY DOCUMENTS\PENN-15.HYG
 HYG ID = 15 Year Inflow
 HYG Tag = 15YR

 Peak Discharge = 185.99 cfs
 Time to Peak = 9.00 min
 HYG Volume = 223173 cu.ft

HYDROGRAPH ORDINATES (cfs)
 Output Time increment = 1.00 min
 Time on left represents time for first value in each row.

Time min					
.00	.00	20.66	41.33	61.99	82.65
5.00	103.31	123.97	144.63	165.29	185.99
10.00	185.99	185.99	185.99	185.99	185.99
15.00	185.99	185.99	185.99	185.99	185.99
20.00	185.99	165.29	144.63	123.97	103.31
25.00	82.65	61.99	41.33	20.66	.00
30.00	.00	.00	.00	.00	.00
35.00	.00	.00	.00	.00	.00
40.00	.00	.00	.00	.00	.00
45.00	.00	.00	.00	.00	.00
50.00	.00	.00	.00	.00	.00
55.00	.00	.00	.00	.00	.00
60.00	.00	.00	.00	.00	.00
65.00	.00	.00	.00	.00	.00
70.00	.00	.00	.00	.00	.00
75.00	.00	.00	.00	.00	.00
80.00	.00	.00	.00	.00	.00
85.00	.00	.00	.00	.00	.00
90.00	.00	.00	.00	.00	.00
95.00	.00	.00	.00	.00	.00
100.00	.00	.00	.00	.00	.00
105.00	.00	.00	.00	.00	.00
110.00	.00	.00	.00	.00	.00
115.00	.00	.00	.00	.00	.00
120.00	.00	.00	.00	.00	.00
125.00	.00	.00	.00	.00	.00
130.00	.00	.00	.00	.00	.00
135.00	.00	.00	.00	.00	.00
140.00	.00	.00	.00	.00	.00
145.00	.00	.00	.00	.00	.00
150.00	.00	.00	.00	.00	.00
155.00	.00	.00	.00	.00	.00

Type.... Read HYG
 Name.... ON-SITE INFLOW
 File.... C:\MY DOCUMENTS\PENNIAL PARK LAKE DETENTION.PPW
 Title... 20 Minute Duration Design Storms
 Storm... Tag: A 15YR

HYDROGRAPH ORDINATES (cfs)
 Output Time increment = 1.00 min
 Time on left represents time for first value in each row.

Time min					
160.00	.00	.00	.00	.00	.00
165.00	.00	.00	.00	.00	.00
170.00	.00	.00	.00	.00	.00
175.00	.00	.00	.00	.00	.00
180.00	.00	.00	.00	.00	.00
185.00	.00	.00	.00	.00	.00
190.00	.00	.00	.00	.00	.00
195.00	.00	.00	.00	.00	.00
200.00	.00	.00	.00	.00	.00
205.00	.00	.00	.00	.00	.00
210.00	.00	.00	.00	.00	.00
215.00	.00	.00	.00	.00	.00
220.00	.00	.00	.00	.00	.00
225.00	.00	.00	.00	.00	.00
230.00	.00	.00	.00	.00	.00
235.00	.00	.00	.00	.00	.00
240.00	.00	.00	.00	.00	.00
245.00	.00	.00	.00	.00	.00
250.00	.00	.00	.00	.00	.00
255.00	.00	.00	.00	.00	.00
260.00	.00	.00	.00	.00	.00
265.00	.00	.00	.00	.00	.00
270.00	.00	.00	.00	.00	.00
275.00	.00	.00	.00	.00	.00
280.00	.00	.00	.00	.00	.00
285.00	.00	.00	.00	.00	.00
290.00	.00	.00	.00	.00	.00
295.00	.00	.00	.00	.00	.00
300.00	.00	.00	.00	.00	.00
305.00	.00	.00	.00	.00	.00
310.00	.00	.00	.00	.00	.00
315.00	.00	.00	.00	.00	.00
320.00	.00	.00	.00	.00	.00
325.00	.00	.00	.00	.00	.00
330.00	.00	.00	.00	.00	.00
335.00	.00	.00	.00	.00	.00
340.00	.00	.00	.00	.00	.00
345.00	.00	.00	.00	.00	.00
350.00	.00	.00	.00	.00	.00
355.00	.00	.00	.00	.00	.00
360.00	.00	.00	.00	.00	.00
365.00	.00	.00	.00	.00	.00
370.00	.00	.00	.00	.00	.00
375.00	.00	.00	.00	.00	.00
380.00	.00	.00	.00	.00	.00
385.00	.00	.00	.00	.00	.00

Type.... Read HYG
 Name.... ON-SITE INFLOW
 File.... C:\MY DOCUMENTS\PENNIAL PARK LAKE DETENTION.PPW
 Title... 20 Minute Duration Design Storms
 Storm... Tag: A 15YR

HYDROGRAPH ORDINATES (cfs)
 Output Time increment = 1.00 min
 Time on left represents time for first value in each row.

Time min					
390.00	.00	.00	.00	.00	.00
395.00	.00	.00	.00	.00	.00
400.00	.00	.00	.00	.00	.00
405.00	.00	.00	.00	.00	.00
410.00	.00	.00	.00	.00	.00
415.00	.00	.00	.00	.00	.00
420.00	.00	.00	.00	.00	.00
425.00	.00	.00	.00	.00	.00
430.00	.00	.00	.00	.00	.00
435.00	.00	.00	.00	.00	.00
440.00	.00	.00	.00	.00	.00
445.00	.00	.00	.00	.00	.00
450.00	.00	.00	.00	.00	.00
455.00	.00	.00	.00	.00	.00
460.00	.00	.00	.00	.00	.00
465.00	.00	.00	.00	.00	.00
470.00	.00	.00	.00	.00	.00
475.00	.00	.00	.00	.00	.00
480.00	.00	.00	.00	.00	.00
485.00	.00	.00	.00	.00	.00
490.00	.00	.00	.00	.00	.00
495.00	.00	.00	.00	.00	.00
500.00	.00	.00	.00	.00	.00
505.00	.00	.00	.00	.00	.00
510.00	.00	.00	.00	.00	.00
515.00	.00	.00	.00	.00	.00
520.00	.00	.00	.00	.00	.00
525.00	.00	.00	.00	.00	.00
530.00	.00	.00	.00	.00	.00
535.00	.00	.00	.00	.00	.00
540.00	.00	.00	.00	.00	.00
545.00	.00	.00	.00	.00	.00
550.00	.00	.00	.00	.00	.00
555.00	.00	.00	.00	.00	.00
560.00	.00	.00	.00	.00	.00
565.00	.00	.00	.00	.00	.00
570.00	.00	.00	.00	.00	.00
575.00	.00	.00	.00	.00	.00
580.00	.00	.00	.00	.00	.00
585.00	.00	.00	.00	.00	.00
590.00	.00	.00	.00	.00	.00
595.00	.00	.00	.00	.00	.00
600.00	.00				

Type.... Read HYG
 Name.... ON-SITE INFLOW
 File.... C:\MY DOCUMENTS\PENNIAL PARK LAKE DETENTION.PPW
 Storm... Tag: B 25YR

HYG file = C:\MY DOCUMENTS\PENN-25.HYG
 HYG ID = 25 Year Inflow
 HYG Tag = 25YR

 Peak Discharge = 229.67 cfs
 Time to Peak = 9.00 min
 HYG Volume = 275605 cu.ft

HYDROGRAPH ORDINATES (cfs)
 Output Time increment = 1.00 min
 Time on left represents time for first value in each row.

Time min					
.00	.00	25.52	51.04	76.56	102.07
5.00	127.60	153.11	178.63	204.15	229.67
10.00	229.67	229.67	229.67	229.67	229.67
15.00	229.67	229.67	229.67	229.67	229.67
20.00	229.67	204.15	178.63	153.11	127.60
25.00	102.07	76.56	51.04	25.52	.00
30.00	.00	.00	.00	.00	.00
35.00	.00	.00	.00	.00	.00
40.00	.00	.00	.00	.00	.00
45.00	.00	.00	.00	.00	.00
50.00	.00	.00	.00	.00	.00
55.00	.00	.00	.00	.00	.00
60.00	.00	.00	.00	.00	.00
65.00	.00	.00	.00	.00	.00
70.00	.00	.00	.00	.00	.00
75.00	.00	.00	.00	.00	.00
80.00	.00	.00	.00	.00	.00
85.00	.00	.00	.00	.00	.00
90.00	.00	.00	.00	.00	.00
95.00	.00	.00	.00	.00	.00
100.00	.00	.00	.00	.00	.00
105.00	.00	.00	.00	.00	.00
110.00	.00	.00	.00	.00	.00
115.00	.00	.00	.00	.00	.00
120.00	.00	.00	.00	.00	.00
125.00	.00	.00	.00	.00	.00
130.00	.00	.00	.00	.00	.00
135.00	.00	.00	.00	.00	.00
140.00	.00	.00	.00	.00	.00
145.00	.00	.00	.00	.00	.00
150.00	.00	.00	.00	.00	.00
155.00	.00	.00	.00	.00	.00
160.00	.00	.00	.00	.00	.00

Type... Read HYG
 Name... ON-SITE INFLOW
 File... C:\MY DOCUMENTS\PENNIAL PARK LAKE DETENTION.PPW
 Storm... Tag: B 25YR

HYDROGRAPH ORDINATES (cfs)
 Output Time increment = 1.00 min
 Time on left represents time for first value in each row.

Time min					
165.00	.00	.00	.00	.00	.00
170.00	.00	.00	.00	.00	.00
175.00	.00	.00	.00	.00	.00
180.00	.00	.00	.00	.00	.00
185.00	.00	.00	.00	.00	.00
190.00	.00	.00	.00	.00	.00
195.00	.00	.00	.00	.00	.00
200.00	.00	.00	.00	.00	.00
205.00	.00	.00	.00	.00	.00
210.00	.00	.00	.00	.00	.00
215.00	.00	.00	.00	.00	.00
220.00	.00	.00	.00	.00	.00
225.00	.00	.00	.00	.00	.00
230.00	.00	.00	.00	.00	.00
235.00	.00	.00	.00	.00	.00
240.00	.00	.00	.00	.00	.00
245.00	.00	.00	.00	.00	.00
250.00	.00	.00	.00	.00	.00
255.00	.00	.00	.00	.00	.00
260.00	.00	.00	.00	.00	.00
265.00	.00	.00	.00	.00	.00
270.00	.00	.00	.00	.00	.00
275.00	.00	.00	.00	.00	.00
280.00	.00	.00	.00	.00	.00
285.00	.00	.00	.00	.00	.00
290.00	.00	.00	.00	.00	.00
295.00	.00	.00	.00	.00	.00
300.00	.00	.00	.00	.00	.00
305.00	.00	.00	.00	.00	.00
310.00	.00	.00	.00	.00	.00
315.00	.00	.00	.00	.00	.00
320.00	.00	.00	.00	.00	.00
325.00	.00	.00	.00	.00	.00
330.00	.00	.00	.00	.00	.00
335.00	.00	.00	.00	.00	.00
340.00	.00	.00	.00	.00	.00
345.00	.00	.00	.00	.00	.00
350.00	.00	.00	.00	.00	.00
355.00	.00	.00	.00	.00	.00
360.00	.00	.00	.00	.00	.00
365.00	.00	.00	.00	.00	.00
370.00	.00	.00	.00	.00	.00
375.00	.00	.00	.00	.00	.00
380.00	.00	.00	.00	.00	.00
385.00	.00	.00	.00	.00	.00
390.00	.00	.00	.00	.00	.00
395.00	.00	.00	.00	.00	.00

Type... Read HYG
 Name... ON-SITE INFLOW
 File... C:\MY DOCUMENTS\PENNIAL PARK LAKE DETENTION.PPW
 Storm... Tag: B 25YR

HYDROGRAPH ORDINATES (cfs)
 Output Time increment = 1.00 min
 Time on left represents time for first value in each row.

Time min					
400.00	.00	.00	.00	.00	.00
405.00	.00	.00	.00	.00	.00
410.00	.00	.00	.00	.00	.00
415.00	.00	.00	.00	.00	.00
420.00	.00	.00	.00	.00	.00
425.00	.00	.00	.00	.00	.00
430.00	.00	.00	.00	.00	.00
435.00	.00	.00	.00	.00	.00
440.00	.00	.00	.00	.00	.00
445.00	.00	.00	.00	.00	.00
450.00	.00	.00	.00	.00	.00
455.00	.00	.00	.00	.00	.00
460.00	.00	.00	.00	.00	.00
465.00	.00	.00	.00	.00	.00
470.00	.00	.00	.00	.00	.00
475.00	.00	.00	.00	.00	.00
480.00	.00	.00	.00	.00	.00
485.00	.00	.00	.00	.00	.00
490.00	.00	.00	.00	.00	.00
495.00	.00	.00	.00	.00	.00
500.00	.00	.00	.00	.00	.00
505.00	.00	.00	.00	.00	.00
510.00	.00	.00	.00	.00	.00
515.00	.00	.00	.00	.00	.00
520.00	.00	.00	.00	.00	.00
525.00	.00	.00	.00	.00	.00
530.00	.00	.00	.00	.00	.00
535.00	.00	.00	.00	.00	.00
540.00	.00	.00	.00	.00	.00
545.00	.00	.00	.00	.00	.00
550.00	.00	.00	.00	.00	.00
555.00	.00	.00	.00	.00	.00
560.00	.00	.00	.00	.00	.00
565.00	.00	.00	.00	.00	.00
570.00	.00	.00	.00	.00	.00
575.00	.00	.00	.00	.00	.00
580.00	.00	.00	.00	.00	.00
585.00	.00	.00	.00	.00	.00
590.00	.00	.00	.00	.00	.00
595.00	.00	.00	.00	.00	.00
600.00	.00				

Type.... Read HYG
 Name.... ON-SITE INFLOW
 File.... C:\MY DOCUMENTS\PENNIAL PARK LAKE DETENTION.PPW
 Storm... Tag: C 100Y

Page 1.52
 Event: C 100YR

HYG file = C:\MY DOCUMENTS\PENN-100.HYG
 HYG ID = 100 Year Inflow
 HYG Tag = 100YR

 Peak Discharge = 293.77 cfs
 Time to Peak = 9.00 min
 HYG Volume = 352520 cu.ft

HYDROGRAPH ORDINATES (cfs)
 Output Time increment = 1.00 min
 Time on left represents time for first value in each row.

Time min					
.00	.00	32.64	65.28	97.92	130.56
5.00	163.20	195.84	228.48	261.12	293.77
10.00	293.77	293.77	293.77	293.77	293.77
15.00	293.77	293.77	293.77	293.77	293.77
20.00	293.77	261.12	228.48	195.84	163.20
25.00	130.56	97.92	65.28	32.64	.00
30.00	.00	.00	.00	.00	.00
35.00	.00	.00	.00	.00	.00
40.00	.00	.00	.00	.00	.00
45.00	.00	.00	.00	.00	.00
50.00	.00	.00	.00	.00	.00
55.00	.00	.00	.00	.00	.00
60.00	.00	.00	.00	.00	.00
65.00	.00	.00	.00	.00	.00
70.00	.00	.00	.00	.00	.00
75.00	.00	.00	.00	.00	.00
80.00	.00	.00	.00	.00	.00
85.00	.00	.00	.00	.00	.00
90.00	.00	.00	.00	.00	.00
95.00	.00	.00	.00	.00	.00
100.00	.00	.00	.00	.00	.00
105.00	.00	.00	.00	.00	.00
110.00	.00	.00	.00	.00	.00
115.00	.00	.00	.00	.00	.00
120.00	.00	.00	.00	.00	.00
125.00	.00	.00	.00	.00	.00
130.00	.00	.00	.00	.00	.00
135.00	.00	.00	.00	.00	.00
140.00	.00	.00	.00	.00	.00
145.00	.00	.00	.00	.00	.00
150.00	.00	.00	.00	.00	.00
155.00	.00	.00	.00	.00	.00
160.00	.00	.00	.00	.00	.00

Type... Read HYG
 Name... ON-SITE INFLOW
 File... C:\MY DOCUMENTS\PENNIAL PARK LAKE DETENTION.PPW
 Storm... Tag: C 100Y

HYDROGRAPH ORDINATES (cfs)
 Output Time increment = 1.00 min
 Time on left represents time for first value in each row.

Time min					
165.00	.00	.00	.00	.00	.00
170.00	.00	.00	.00	.00	.00
175.00	.00	.00	.00	.00	.00
180.00	.00	.00	.00	.00	.00
185.00	.00	.00	.00	.00	.00
190.00	.00	.00	.00	.00	.00
195.00	.00	.00	.00	.00	.00
200.00	.00	.00	.00	.00	.00
205.00	.00	.00	.00	.00	.00
210.00	.00	.00	.00	.00	.00
215.00	.00	.00	.00	.00	.00
220.00	.00	.00	.00	.00	.00
225.00	.00	.00	.00	.00	.00
230.00	.00	.00	.00	.00	.00
235.00	.00	.00	.00	.00	.00
240.00	.00	.00	.00	.00	.00
245.00	.00	.00	.00	.00	.00
250.00	.00	.00	.00	.00	.00
255.00	.00	.00	.00	.00	.00
260.00	.00	.00	.00	.00	.00
265.00	.00	.00	.00	.00	.00
270.00	.00	.00	.00	.00	.00
275.00	.00	.00	.00	.00	.00
280.00	.00	.00	.00	.00	.00
285.00	.00	.00	.00	.00	.00
290.00	.00	.00	.00	.00	.00
295.00	.00	.00	.00	.00	.00
300.00	.00	.00	.00	.00	.00
305.00	.00	.00	.00	.00	.00
310.00	.00	.00	.00	.00	.00
315.00	.00	.00	.00	.00	.00
320.00	.00	.00	.00	.00	.00
325.00	.00	.00	.00	.00	.00
330.00	.00	.00	.00	.00	.00
335.00	.00	.00	.00	.00	.00
340.00	.00	.00	.00	.00	.00
345.00	.00	.00	.00	.00	.00
350.00	.00	.00	.00	.00	.00
355.00	.00	.00	.00	.00	.00
360.00	.00	.00	.00	.00	.00
365.00	.00	.00	.00	.00	.00
370.00	.00	.00	.00	.00	.00
375.00	.00	.00	.00	.00	.00
380.00	.00	.00	.00	.00	.00
385.00	.00	.00	.00	.00	.00
390.00	.00	.00	.00	.00	.00
395.00	.00	.00	.00	.00	.00

HYDROGRAPH ORDINATES (cfs)
 Output Time increment = 1.00 min
 Time on left represents time for first value in each row.

Time min					
400.00	.00	.00	.00	.00	.00
405.00	.00	.00	.00	.00	.00
410.00	.00	.00	.00	.00	.00
415.00	.00	.00	.00	.00	.00
420.00	.00	.00	.00	.00	.00
425.00	.00	.00	.00	.00	.00
430.00	.00	.00	.00	.00	.00
435.00	.00	.00	.00	.00	.00
440.00	.00	.00	.00	.00	.00
445.00	.00	.00	.00	.00	.00
450.00	.00	.00	.00	.00	.00
455.00	.00	.00	.00	.00	.00
460.00	.00	.00	.00	.00	.00
465.00	.00	.00	.00	.00	.00
470.00	.00	.00	.00	.00	.00
475.00	.00	.00	.00	.00	.00
480.00	.00	.00	.00	.00	.00
485.00	.00	.00	.00	.00	.00
490.00	.00	.00	.00	.00	.00
495.00	.00	.00	.00	.00	.00
500.00	.00	.00	.00	.00	.00
505.00	.00	.00	.00	.00	.00
510.00	.00	.00	.00	.00	.00
515.00	.00	.00	.00	.00	.00
520.00	.00	.00	.00	.00	.00
525.00	.00	.00	.00	.00	.00
530.00	.00	.00	.00	.00	.00
535.00	.00	.00	.00	.00	.00
540.00	.00	.00	.00	.00	.00
545.00	.00	.00	.00	.00	.00
550.00	.00	.00	.00	.00	.00
555.00	.00	.00	.00	.00	.00
560.00	.00	.00	.00	.00	.00
565.00	.00	.00	.00	.00	.00
570.00	.00	.00	.00	.00	.00
575.00	.00	.00	.00	.00	.00
580.00	.00	.00	.00	.00	.00
585.00	.00	.00	.00	.00	.00
590.00	.00	.00	.00	.00	.00
595.00	.00	.00	.00	.00	.00
600.00	.00	.00	.00	.00	.00

Type.... Vol: Planimeter
Name.... PENNIAL LAKE

File.... C:\MY DOCUMENTS\PENNIAL PARK LAKE DETENTION.PPW
Title... Lake in Pennial Park

POND VOLUME CALCULATIONS

Planimeter scale: 1.00 ft/in

Elevation (ft)	Planimeter (sq.in)	Area (acres)	A1+A2+sqr(A1*A2) (acres)	Volume (cu.ft)	Volume Sum (cu.ft)
516.00	62509.920	1.4350	.0000	0	0
518.00	68786.590	1.5791	4.5195	131247	131247
520.00	75291.070	1.7284	4.9597	144029	275275
522.00	82022.320	1.8830	5.4155	157265	432541
524.00	90157.310	2.0697	5.9268	172116	604656

POND VOLUME EQUATIONS

* Incremental volume computed by the Conic Method for Reservoir Volumes.

$$\text{Volume} = (1/3) * (\text{EL2}-\text{EL1}) * (\text{Area1} + \text{Area2} + \text{sq.rt.}(\text{Area1}*\text{Area2}))$$

where: EL1, EL2 = Lower and upper elevations of the increment
Area1,Area2 = Areas computed for EL1, EL2, respectively
Volume = Incremental volume between EL1 and EL2

Type.... Outlet Input Data
Name.... TRIPLE BOX W/BOX

File.... C:\MY DOCUMENTS\PENNIAL PARK LAKE DETENTION.PPW
Title... Triple Box Structure in Pennial Park Lake

REQUESTED POND WS ELEVATIONS:

Min. Elev.= 516.00 ft
Increment = .10 ft
Max. Elev.= 524.00 ft

OUTLET CONNECTIVITY

---> Forward Flow Only (UpStream to DnStream)
<--- Reverse Flow Only (DnStream to UpStream)
<---> Forward and Reverse Both Allowed

Structure	No.		Outfall	E1, ft	E2, ft
-----	-----		-----	-----	-----
Weir-XY Points	ES	--->	TW	522.000	524.000
Inlet Box	OX	--->	CV	518.600	524.000
Weir-Rectangular	SL	--->	CV	516.000	524.000
Culvert-Box	CV	--->	TW	514.300	524.000
TW SETUP, DS Channel					

Type.... Outlet Input Data
Name.... TRIPLE BOX W/BOX

File.... C:\MY DOCUMENTS\PENNIAL PARK LAKE DETENTION.PPW
Title... Triple Box Structure in Pennial Park Lake

OUTLET STRUCTURE INPUT DATA

Structure ID = ES
Structure Type = Weir-XY Points

of Openings = 1
WEIR X-Y GROUND POINTS

X, ft	Elev, ft
-----	-----
.00	524.00
6.00	522.00
36.00	522.00
42.00	524.00

Lowest Elev. = 522.00 ft

Weir Table File: EARTH.WCT
Weir Table ID: Emer. Spillway
WEIR COEFFICIENT TABLE

Depth, ft	Weir C
-----	-----
.50	3.0000
1.00	2.7500
2.00	2.5500

Weir TW effects (Use adjustment equation)

Type.... Outlet Input Data
Name.... TRIPLE BOX W/BOX

File.... C:\MY DOCUMENTS\PENNIAL PARK LAKE DETENTION.PPW
Title... Triple Box Structure in Pennial Park Lake

OUTLET STRUCTURE INPUT DATA

Structure ID = BOX
Structure Type = Inlet Box

of Openings = 1
Invert Elev. = 518.60 ft
Orifice Area = 52.6800 sq.ft
Orifice Coeff. = .600
Weir Length = 34.34 ft
Weir Coeff. = 3.000
K, Submerged = .000
K, Reverse = 1.000
Kb, Barrel = .000000 (per ft of full flow)
Barrel Length = .00 ft
Mannings n = .0000

Structure ID = SL
Structure Type = Weir-Rectangular

of Openings = 1
Crest Elev. = 516.00 ft
Weir Length = 10.00 ft
Weir Coeff. = 3.000000

Weir TW effects (Use adjustment equation)

Type.... Outlet Input Data
Name.... TRIPLE BOX W/BOX

File.... C:\MY DOCUMENTS\PENNIAL PARK LAKE DETENTION.PPW
Title... Triple Box Structure in Pennial Park Lake

OUTLET STRUCTURE INPUT DATA

Structure ID = CV
Structure Type = Culvert-Box

No. Barrels = 1
Barrel Height = 3.00 ft
Barrel Width = 6.00 ft
Upstream Invert = 514.30 ft
Dnstream Invert = 514.00 ft
Horiz. Length = 73.05 ft
Barrel Length = 73.05 ft
Barrel Slope = .00411 ft/ft

OUTLET CONTROL DATA...

Mannings n = .0130
Ke = .5000 (forward entrance loss)
Kb = .004925 (per ft of full flow)
Kr = .5000 (reverse entrance loss)
HW Convergence = .010 +/- ft

INLET CONTROL DATA...

Equation form = 2
Inlet Control K = .4950
Inlet Control M = .6670
Inlet Control c = .03140
Inlet Control Y = .8200
T1 ratio (HW/D) = 1.142
T2 ratio (HW/D) = 1.320
Slope Factor = -.500

Use unsubmerged inlet control Form 2 equ. below T1 elev.
Use submerged inlet control Form 2 equ. above T2 elev.

In transition zone between unsubmerged and submerged inlet control,
interpolate between flows at T1 & T2...

At T1 Elev = 517.72 ft ---> Flow = 109.12 cfs
At T2 Elev = 518.26 ft ---> Flow = 124.71 cfs

Type.... Outlet Input Data
Name.... TRIPLE BOX W/BOX

Page 3.05

File.... C:\MY DOCUMENTS\PENNIAL PARK LAKE DETENTION.PPW
Title... Triple Box Structure in Pennial Park Lake

OUTLET STRUCTURE INPUT DATA

Structure ID = TW
Structure Type = TW SETUP, DS Channel

FREE OUTFALL CONDITIONS SPECIFIED

CONVERGENCE TOLERANCES...
Maximum Iterations= 30
Min. TW tolerance = .01 ft
Max. TW tolerance = .01 ft
Min. HW tolerance = .01 ft
Max. HW tolerance = .01 ft
Min. Q tolerance = .10 cfs
Max. Q tolerance = .10 cfs

File.... C:\MY DOCUMENTS\PENNIAL PARK LAKE DETENTION.PPW
 Title... Triple Box Structure in Pennial Park Lake

***** COMPOSITE OUTFLOW SUMMARY *****

WS Elev, Total Q		Converge		Notes
Elev. ft	Q cfs	TW Elev ft	Error +/-ft	Contributing Structures
516.00	.00	Free Outfall		(no Q: ES,BOX,SL,CV)
516.10	.95	Free Outfall		SL,CV (no Q: ES,BOX)
516.20	2.68	Free Outfall		SL,CV (no Q: ES,BOX)
516.30	4.93	Free Outfall		SL,CV (no Q: ES,BOX)
516.40	7.59	Free Outfall		SL,CV (no Q: ES,BOX)
516.50	10.61	Free Outfall		SL,CV (no Q: ES,BOX)
516.60	13.94	Free Outfall		SL,CV (no Q: ES,BOX)
516.70	17.57	Free Outfall		SL,CV (no Q: ES,BOX)
516.80	21.47	Free Outfall		SL,CV (no Q: ES,BOX)
516.90	25.62	Free Outfall		SL,CV (no Q: ES,BOX)
517.00	30.00	Free Outfall		SL,CV (no Q: ES,BOX)
517.10	34.40	Free Outfall		SL,CV (no Q: ES,BOX)
517.20	38.39	Free Outfall		SL,CV (no Q: ES,BOX)
517.30	42.30	Free Outfall		SL,CV (no Q: ES,BOX)
517.40	46.05	Free Outfall		SL,CV (no Q: ES,BOX)
517.50	49.95	Free Outfall		SL,CV (no Q: ES,BOX)
517.60	53.65	Free Outfall		SL,CV (no Q: ES,BOX)
517.70	57.63	Free Outfall		SL,CV (no Q: ES,BOX)
517.80	61.27	Free Outfall		SL,CV (no Q: ES,BOX)
517.90	65.15	Free Outfall		SL,CV (no Q: ES,BOX)
518.00	69.03	Free Outfall		SL,CV (no Q: ES,BOX)
518.10	73.20	Free Outfall		SL,CV (no Q: ES,BOX)
518.20	76.91	Free Outfall		SL,CV (no Q: ES,BOX)
518.30	80.87	Free Outfall		SL,CV (no Q: ES,BOX)
518.40	84.89	Free Outfall		SL,CV (no Q: ES,BOX)
518.50	90.90	Free Outfall		SL,CV (no Q: ES,BOX)
518.60	91.13	Free Outfall		SL,CV (no Q: ES,BOX)
518.70	104.91	Free Outfall		BOX,SL,CV (no Q: ES)
518.80	103.90	Free Outfall		BOX,SL,CV (no Q: ES)
518.90	120.51	Free Outfall		BOX,SL,CV (no Q: ES)
519.00	123.84	Free Outfall		BOX,SL,CV (no Q: ES)
519.10	154.42	Free Outfall		BOX,CV (no Q: ES,SL)
519.20	158.69	Free Outfall		BOX,CV (no Q: ES,SL)
519.30	162.12	Free Outfall		BOX,CV (no Q: ES,SL)
519.40	165.18	Free Outfall		BOX,CV (no Q: ES,SL)
519.50	168.61	Free Outfall		BOX,CV (no Q: ES,SL)
519.60	171.66	Free Outfall		BOX,CV (no Q: ES,SL)
519.70	174.33	Free Outfall		BOX,CV (no Q: ES,SL)
519.80	176.92	Free Outfall		BOX,CV (no Q: ES,SL)

File.... C:\MY DOCUMENTS\PENNIAL PARK LAKE DETENTION.PPW
 Title... Triple Box Structure in Pennial Park Lake

***** COMPOSITE OUTFLOW SUMMARY *****

WS Elev, Total Q		Converge		Notes
Elev. ft	Q cfs	TW Elev ft	Error +/-ft	Contributing Structures
519.90	180.05	Free Outfall		BOX,CV (no Q: ES,SL)
520.00	183.11	Free Outfall		BOX,CV (no Q: ES,SL)
520.10	185.78	Free Outfall		BOX,CV (no Q: ES,SL)
520.20	188.45	Free Outfall		BOX,CV (no Q: ES,SL)
520.30	191.50	Free Outfall		BOX,CV (no Q: ES,SL)
520.40	193.79	Free Outfall		BOX,CV (no Q: ES,SL)
520.50	196.84	Free Outfall		BOX,CV (no Q: ES,SL)
520.60	199.13	Free Outfall		BOX,CV (no Q: ES,SL)
520.70	201.80	Free Outfall		BOX,CV (no Q: ES,SL)
520.80	204.47	Free Outfall		BOX,CV (no Q: ES,SL)
520.90	206.76	Free Outfall		BOX,CV (no Q: ES,SL)
521.00	209.43	Free Outfall		BOX,CV (no Q: ES,SL)
521.10	211.72	Free Outfall		BOX,CV (no Q: ES,SL)
521.20	214.39	Free Outfall		BOX,CV (no Q: ES,SL)
521.30	216.67	Free Outfall		BOX,CV (no Q: ES,SL)
521.40	218.96	Free Outfall		BOX,CV (no Q: ES,SL)
521.50	221.25	Free Outfall		BOX,CV (no Q: ES,SL)
521.60	223.54	Free Outfall		BOX,CV (no Q: ES,SL)
521.70	225.83	Free Outfall		BOX,CV (no Q: ES,SL)
521.80	228.12	Free Outfall		BOX,CV (no Q: ES,SL)
521.90	230.41	Free Outfall		BOX,CV (no Q: ES,SL)
522.00	232.70	Free Outfall		BOX,CV (no Q: ES,SL)
522.10	237.85	Free Outfall		ES,BOX,CV (no Q: SL)
522.20	245.44	Free Outfall		ES,BOX,CV (no Q: SL)
522.30	254.28	Free Outfall		ES,BOX,CV (no Q: SL)
522.40	264.88	Free Outfall		ES,BOX,CV (no Q: SL)
522.50	276.32	Free Outfall		ES,BOX,CV (no Q: SL)
522.60	288.57	Free Outfall		ES,BOX,CV (no Q: SL)
522.70	301.14	Free Outfall		ES,BOX,CV (no Q: SL)
522.80	314.68	Free Outfall		ES,BOX,CV (no Q: SL)
522.90	328.38	Free Outfall		ES,BOX,CV (no Q: SL)
523.00	342.92	Free Outfall		ES,BOX,CV (no Q: SL)
523.10	358.46	Free Outfall		ES,BOX,CV (no Q: SL)
523.20	374.62	Free Outfall		ES,BOX,CV (no Q: SL)
523.30	391.35	Free Outfall		ES,BOX,CV (no Q: SL)
523.40	408.64	Free Outfall		ES,BOX,CV (no Q: SL)
523.50	426.83	Free Outfall		ES,BOX,CV (no Q: SL)
523.60	445.14	Free Outfall		ES,BOX,CV (no Q: SL)
523.70	463.93	Free Outfall		ES,BOX,CV (no Q: SL)

Type.... Composite Rating Curve
Name.... TRIPLE BOX W/BOX

File.... C:\MY DOCUMENTS\PENNIAL PARK LAKE DETENTION.PPW
Title... Triple Box Structure in Pennial Park Lake

***** COMPOSITE OUTFLOW SUMMARY *****

WS Elev, Total Q		Converge		Notes
Elev. ft	Q cfs	TW Elev ft	Error +/-ft	Contributing Structures
523.80	483.16	Free Outfall		ES,BOX,CV (no Q: SL)
523.90	502.83	Free Outfall		ES,BOX,CV (no Q: SL)
524.00	522.89	Free Outfall		ES,BOX,CV (no Q: SL)

Type.... Node: Pond Inflow Summary
 Name.... PENNIAL LAKE IN
 File.... C:\MY DOCUMENTS\PENNIAL PARK LAKE DETENTION.PPW
 Storm... A 15YR Tag: A 15YR

Page 4.01
 Event: A 15YR

SUMMARY FOR HYDROGRAPH ADDITION
 at Node: PENNIAL LAKE IN

HYG Directory: C:\MY DOCUMENTS\

```

=====
Upstream Link ID  Upstream Node ID  HYG file  HYG ID  HYG tag
-----
CHERRY IN        CHERRY FLOWS        Cherry Out 15  15yr
INFLOW 2         LEGACY OUTFLOW      LEGACY 15 yr OUT15YR
INFLOW 3         HUTCHINGS OUT       15 Year, Outflow15YR
INFLOW 5         OFFSITE AREA 3     Off Area 3-15yr 15YR
INFLOW           OFFSITE AREA 4     Offsite 4 15yr  15YR
INFLOW 4         ON-SITE INFLOW     15 Year Inflow  15YR
OFFSITE INFLOW   OFF AREA 2         Hutch offsite 2 15yr
=====

```

INFLOWS TO: PENNIAL LAKE IN

```

-----
HYG file  HYG ID  HYG tag  Volume  Peak Time  Peak Flow
          cu.ft  min      cfs
-----
          Cherry Out 15  15yr      76070    38.00     16.08
          LEGACY 15 yr OUT 15YR      83643    26.00     56.93
          15 Year, Outflow 15YR     152986    40.00     13.75
          Off Area 3-15yr 15YR      55674     9.00     46.30
          Offsite 4 15yr 15YR      48468    10.00     40.39
          15 Year Inflow 15YR     223173     9.00    185.99
          Hutch offsite 2 15yr      7568     7.00      6.31
-----

```

TOTAL FLOW INTO: PENNIAL LAKE IN

```

-----
HYG file  HYG ID  HYG tag  Volume  Peak Time  Peak Flow
          cu.ft  min      cfs
-----
          PENNIAL LAKE IN  A 15YR    637548    20.00     322.36
-----

```

Type.... Node: Pond Inflow Summary
 Name.... PENNIAL LAKE IN
 File..... C:\MY DOCUMENTS\PENNIAL PARK LAKE DETENTION.PPW
 Storm... A 15YR Tag: A 15YR

TOTAL NODE INFLOW...
 HYG file =
 HYG ID = PENNIAL LAKE IN
 HYG Tag = A 15YR

 Peak Discharge = 322.36 cfs
 Time to Peak = 20.00 min
 HYG Volume = 637548 cu.ft

HYDROGRAPH ORDINATES (cfs)
 Output Time increment = 1.00 min
 Time on left represents time for first value in each row.

Time min					
.00	.00	30.74	61.50	92.24	123.20
5.00	154.70	186.13	217.90	248.84	280.05
10.00	286.06	288.48	291.33	294.81	298.58
15.00	302.79	307.08	310.90	314.71	318.68
20.00	322.36	295.97	272.44	250.22	226.84
25.00	202.43	175.74	145.84	114.57	81.48
30.00	73.24	68.58	63.40	59.29	56.50
35.00	55.35	54.27	53.15	52.09	51.02
40.00	49.99	48.93	47.90	46.85	45.84
45.00	44.87	43.95	43.05	42.21	41.38
50.00	40.60	39.85	39.13	38.42	37.76
55.00	37.12	36.50	35.89	35.31	34.75
60.00	34.22	33.69	33.18	32.69	32.22
65.00	31.75	31.30	30.85	30.42	30.01
70.00	29.60	29.20	28.81	28.42	28.05
75.00	27.67	27.32	26.96	26.61	26.27
80.00	25.94	25.55	25.13	24.71	24.32
85.00	23.93	23.54	23.17	22.84	22.52
90.00	22.21	21.90	21.60	21.34	21.08
95.00	20.72	20.32	19.93	19.54	19.18
100.00	18.82	18.47	18.14	17.81	17.54
105.00	17.29	17.05	16.80	16.58	16.34
110.00	16.12	15.90	15.68	15.47	15.26
115.00	15.05	14.85	14.66	14.47	14.29
120.00	14.12	13.94	13.77	13.60	13.44
125.00	13.26	13.11	12.96	12.80	12.65
130.00	12.48	12.31	12.15	11.99	11.84
135.00	11.68	11.54	11.39	11.25	11.10
140.00	10.97	10.83	10.71	10.57	10.38
145.00	10.19	10.02	9.86	9.69	9.54
150.00	9.40	9.25	9.12	8.99	8.87
155.00	8.75	8.63	8.51	8.40	8.27
160.00	8.17	8.06	7.97	7.86	7.78

HYDROGRAPH ORDINATES (cfs)

Output Time increment = 1.00 min

Time on left represents time for first value in each row.

Time min					
165.00	7.69	7.61	7.53	7.45	7.38
170.00	7.30	7.23	7.16	7.11	7.03
175.00	6.95	6.88	6.83	6.76	6.70
180.00	6.65	6.59	6.54	6.49	6.44
185.00	6.40	6.35	6.30	6.26	6.23
190.00	6.21	6.17	6.12	6.07	6.02
195.00	6.00	5.98	5.93	5.90	5.86
200.00	5.81	5.77	5.74	5.70	5.66
205.00	5.62	5.58	5.53	5.50	5.46
210.00	5.42	5.38	5.35	5.31	5.27
215.00	5.23	5.20	5.17	5.13	5.09
220.00	5.06	5.03	5.00	4.95	4.92
225.00	4.89	4.86	4.82	4.79	4.75
230.00	4.72	4.69	4.66	4.63	4.60
235.00	4.56	4.53	4.50	4.47	4.44
240.00	4.41	4.37	4.34	4.31	4.28
245.00	4.25	4.23	4.19	4.16	4.13
250.00	4.11	4.08	4.04	4.01	3.99
255.00	3.96	3.94	3.81	3.78	3.75
260.00	3.73	3.70	3.68	3.65	3.63
265.00	3.60	3.58	3.55	3.53	3.50
270.00	3.48	3.46	3.44	3.41	3.39
275.00	3.36	3.34	3.32	3.30	3.27
280.00	3.25	3.23	3.21	3.18	3.16
285.00	3.14	3.12	3.10	3.08	3.05
290.00	3.03	3.01	2.99	2.97	2.95
295.00	2.93	2.91	2.89	2.87	2.85
300.00	2.83	2.81	2.79	2.77	2.75
305.00	2.73	2.71	2.69	2.68	2.66
310.00	2.64	2.62	2.60	2.58	2.57
315.00	2.55	2.53	2.51	2.50	2.48
320.00	2.46	2.44	2.43	2.41	2.39
325.00	2.37	2.36	2.34	2.33	2.31
330.00	2.29	2.27	2.26	2.24	2.23
335.00	2.21	2.20	2.18	2.17	2.15
340.00	2.14	2.12	2.11	2.09	2.08
345.00	2.06	2.05	2.03	2.02	2.00
350.00	1.99	1.97	1.96	1.95	1.94
355.00	1.92	1.91	1.89	1.88	1.87
360.00	1.86	1.84	1.83	1.81	1.80
365.00	1.79	1.78	1.76	1.75	1.74
370.00	1.73	1.71	1.70	1.69	1.68
375.00	1.67	1.66	1.64	1.63	1.62
380.00	1.61	1.60	1.59	1.57	1.56
385.00	1.55	1.54	1.53	1.52	1.51
390.00	1.50	1.49	1.48	1.47	1.46
395.00	1.45	1.44	1.43	1.42	1.41

Type.... Node: Pond Inflow Summary

Page 4.04

Name.... PENNIAL LAKE IN

Event: A 15YR

File.... C:\MY DOCUMENTS\PENNIAL PARK LAKE DETENTION.PPW

Storm... A 15YR Tag: A 15YR

HYDROGRAPH ORDINATES (cfs)
Output Time increment = 1.00 min
Time on left represents time for first value in each row.

Time min		
400.00	1.40	.00

S/N: f21101d06a84 Bax Engineering

PondPack Ver: 7.0 (325)

Compute Time: 12:52:05

Date: 08-12-2002

Type.... Node: Pond Inflow Summary
 Name.... PENNIAL LAKE IN
 File.... C:\MY DOCUMENTS\PENNIAL PARK LAKE DETENTION.PPW
 Storm... B 25YR Tag: B 25YR

Page 4.05
 Event: B 25YR

SUMMARY FOR HYDROGRAPH ADDITION
 at Node: PENNIAL LAKE IN

HYG Directory: C:\MY DOCUMENTS\

```

=====
Upstream Link ID  Upstream Node ID  HYG file      HYG ID          HYG tag
-----
CHERRY IN        CHERRY FLOWS          Cherry out 25   25yr
INFLOW 2         LEGACY OUTFLOW        Legacy 25 yr out25YR
INFLOW 3         HUTCHINGS OUT        25 Year Outflow 25YR
INFLOW 5         OFFSITE AREA 3       Off Area 3-25yr 25YR
INFLOW           OFFSITE AREA 4       Offsite 4 25yr 25YR
INFLOW 4         ON-SITE INFLOW       25 Year Inflow 25YR
OFFSITE INFLOW   OFF AREA 2           Hutch off 2     25yr
=====

```

INFLOWS TO: PENNIAL LAKE IN

```

-----
HYG file          HYG ID          HYG tag          Volume      Peak Time      Peak Flow
                   cu.ft          min              cfs
-----
Cherry out 25     25yr            94001            36.00        26.79
Legacy 25 yr out 25YR            206673           46.00        78.87
25 Year Outflow  25YR            184685           40.00        15.76
Off Area 3-25yr  25YR            68608            9.00         57.18
Offsite 4 25yr   25YR            59856            10.00        49.88
25 Year Inflow   25YR            275605           9.00         229.67
Hutch off 2      25yr            9347             7.00         7.79
-----

```

TOTAL FLOW INTO: PENNIAL LAKE IN

```

-----
HYG file          HYG ID          HYG tag          Volume      Peak Time      Peak Flow
                   cu.ft          min              cfs
-----
PENNIAL LAKE IN  B 25YR          882941           20.00        375.36
-----

```

Type... Node: Pond Inflow Summary
 Name... PENNIAL LAKE IN
 File... C:\MY DOCUMENTS\PENNIAL PARK LAKE DETENTION.PPW
 Storm... B 25YR Tag: B 25YR

TOTAL NODE INFLOW...

HYG file =
 HYG ID = PENNIAL LAKE IN
 HYG Tag = B 25YR

 Peak Discharge = 375.36 cfs
 Time to Peak = 20.00 min
 HYG Volume = 882941 cu.ft

HYDROGRAPH ORDINATES (cfs)

Output Time increment = 1.00 min
 Time on left represents time for first value in each row.

Time min					
.00	.00	37.97	75.95	113.91	152.14
5.00	190.78	229.51	268.52	306.21	344.30
10.00	350.46	352.05	353.74	355.86	358.43
15.00	361.16	363.56	366.52	369.40	372.39
20.00	375.36	340.56	305.76	271.00	236.18
25.00	201.03	165.85	130.43	96.06	62.66
30.00	61.30	67.81	73.82	80.86	87.47
35.00	93.21	98.60	102.52	106.15	108.60
40.00	110.80	111.86	112.69	112.67	112.80
45.00	112.29	111.81	109.77	108.23	105.67
50.00	103.11	99.71	96.31	92.49	88.67
55.00	84.52	80.37	76.34	72.32	68.35
60.00	64.39	61.65	58.91	57.45	55.99
65.00	55.11	54.23	53.38	52.54	51.72
70.00	50.91	50.14	49.37	48.61	47.87
75.00	47.16	46.45	45.77	45.08	44.42
80.00	43.77	43.13	42.50	41.90	41.28
85.00	40.69	40.11	39.54	38.98	38.43
90.00	37.84	37.22	36.61	36.01	35.42
95.00	34.85	34.30	33.78	33.28	32.79
100.00	32.31	31.84	31.38	30.93	30.46
105.00	29.90	29.36	28.83	28.31	27.80
110.00	27.31	26.85	26.39	25.98	25.60
115.00	25.23	24.88	24.38	23.88	23.54
120.00	23.21	22.89	22.58	22.27	21.96
125.00	21.65	21.37	21.08	20.80	20.53
130.00	20.26	19.99	19.74	19.48	19.24
135.00	18.99	18.75	18.51	18.28	18.03
140.00	17.79	17.55	17.31	17.08	16.85
145.00	16.63	16.42	16.20	15.99	15.78
150.00	15.59	15.39	15.20	14.96	14.71
155.00	14.47	14.25	14.03	13.82	13.60
160.00	13.40	13.21	13.02	12.85	12.68

HYDROGRAPH ORDINATES (cfs)					
Time min	Output Time increment = 1.00 min				
	Time on left represents time for first value in each row.				
165.00	12.51	12.36	12.18	12.01	11.85
170.00	11.69	11.55	11.40	11.26	11.14
175.00	11.00	10.87	10.74	10.63	10.51
180.00	10.40	10.29	10.18	10.07	9.96
185.00	9.85	9.75	9.64	9.54	9.45
190.00	9.36	9.28	9.20	9.11	9.03
195.00	8.95	8.87	8.79	8.72	8.65
200.00	8.58	8.50	8.43	8.36	8.29
205.00	8.22	8.15	8.08	8.02	7.95
210.00	7.89	7.82	7.76	7.70	7.64
215.00	7.57	7.50	7.44	7.38	7.32
220.00	7.27	7.21	7.15	7.09	7.03
225.00	6.97	6.91	6.86	6.81	6.75
230.00	6.70	6.65	6.60	6.55	6.50
235.00	6.44	6.39	6.34	6.30	6.25
240.00	6.20	6.15	6.11	6.06	6.01
245.00	5.97	5.93	5.88	5.83	5.78
250.00	5.74	5.71	5.69	5.65	5.61
255.00	5.56	5.52	5.48	5.44	5.40
260.00	5.36	5.31	5.27	5.23	5.19
265.00	5.15	5.11	5.07	5.03	4.99
270.00	4.96	4.92	4.89	4.85	4.81
275.00	4.77	4.74	4.70	4.67	4.63
280.00	4.59	4.56	4.53	4.49	4.45
285.00	4.42	4.39	4.36	4.33	4.29
290.00	4.26	4.23	4.20	4.17	4.14
295.00	4.10	4.07	4.04	4.01	3.98
300.00	3.95	3.46	3.44	3.41	3.39
305.00	3.37	3.35	3.32	3.30	3.28
310.00	3.26	3.23	3.21	3.19	3.17
315.00	3.14	3.12	3.10	3.08	3.06
320.00	3.04	3.02	3.00	2.97	2.95
325.00	2.93	2.91	2.89	2.87	2.85
330.00	2.83	2.81	2.79	2.77	2.76
335.00	2.74	2.72	2.70	2.68	2.66
340.00	2.64	2.62	2.61	2.59	2.57
345.00	2.55	2.53	2.51	2.50	2.48
350.00	2.46	2.44	2.43	2.41	2.40
355.00	2.38	2.36	2.34	2.33	2.31
360.00	2.30	2.28	2.26	2.24	2.23
365.00	2.21	2.20	2.18	2.17	2.15
370.00	2.14	2.12	2.11	2.09	2.08
375.00	2.06	2.05	2.03	2.02	2.00
380.00	1.99	1.98	1.97	1.95	1.94
385.00	1.92	1.91	1.89	1.88	1.87
390.00	1.86	1.84	1.83	1.82	1.81
395.00	1.79	1.78	1.77	1.76	1.74

Type.... Node: Pond Inflow Summary

Page 4.08

Name.... PENNIAL LAKE IN

Event: B 25YR

File.... C:\MY DOCUMENTS\PENNIAL PARK LAKE DETENTION.PPW

Storm... B 25YR Tag: B 25YR

HYDROGRAPH ORDINATES (cfs)
Output Time increment = 1.00 min
Time on left represents time for first value in each row.

Time min		
400.00	1.73	.00

S/N: f21101d06a84 Bax Engineering

PondPack Ver: 7.0 (325)

Compute Time: 12:52:05

Date: 08-12-2002

SUMMARY FOR HYDROGRAPH ADDITION
at Node: PENNIAL LAKE IN

HYG Directory: C:\MY DOCUMENTS\

```

=====
Upstream Link ID  Upstream Node ID  HYG file      HYG ID          HYG tag
-----
CHERRY IN        CHERRY FLOWS          Cherry out 100  100yr
INFLOW 2         LEGACY OUTFLOW        LGCY 100 Yr Out 100YR
INFLOW 3         HUTCHINGS OUT         100 Year Outflow100YR
INFLOW 5         OFFSITE AREA 3       Off Area 3-100yr100YR
INFLOW          OFFSITE AREA 4       Offsite 4 100yr 100YR
INFLOW 4         ON-SITE INFLOW        100 Year Inflow 100YR
OFFSITE INFLOW   OFF AREA 2           Hutch off 2     100yr
=====
    
```

INFLOWS TO: PENNIAL LAKE IN

```

-----
HYG file          HYG ID          HYG tag          Volume      Peak Time      Peak Flow
                   cu.ft          min              cfs
-----
                   Cherry out 100  100yr          133038        34.00          50.13
                   LGCY 100 Yr Out 100YR          132259        25.00          105.11
                   100 Year Outflow 100YR          239263        40.00          22.54
                   Off Area 3-100yr 100YR          87774         9.00           73.14
                   Offsite 4 100yr 100YR          76560         10.00          63.80
                   100 Year Inflow 100YR          352520        9.00          293.77
                   Hutch off 2     100yr          11952         7.00           9.96
    
```

TOTAL FLOW INTO: PENNIAL LAKE IN

```

-----
HYG file          HYG ID          HYG tag          Volume      Peak Time      Peak Flow
                   cu.ft          min              cfs
-----
                   PENNIAL LAKE IN  C 100Y          1016135       20.00          548.82
    
```

Type... Node: Pond Inflow Summary
 Name... PENNIAL LAKE IN
 File... C:\MY DOCUMENTS\PENNIAL PARK LAKE DETENTION.PPW
 Storm... C 100YR Tag: C 100Y

Page 4.10
 Event: C 100YR

TOTAL NODE INFLOW...

HYG file =
 HYG ID = PENNIAL LAKE IN
 HYG Tag = C 100Y

 Peak Discharge = 548.82 cfs
 Time to Peak = 20.00 min
 HYG Volume = 1016135 cu.ft

HYDROGRAPH ORDINATES (cfs)					
Time min	Output Time increment = 1.00 min				
	Time on left represents time for first value in each row.				
.00	.00	48.57	97.14	145.71	194.61
5.00	243.98	293.65	343.46	392.46	442.17
10.00	451.83	456.04	461.44	467.68	473.87
15.00	480.39	487.39	503.58	521.54	537.03
20.00	548.82	509.24	467.56	425.01	385.66
25.00	346.66	305.16	258.11	208.83	154.89
30.00	139.74	129.83	119.83	110.40	103.25
35.00	98.99	97.54	96.23	94.79	92.95
40.00	91.01	87.30	83.05	78.37	73.42
45.00	68.85	64.68	61.42	58.42	55.65
50.00	53.07	51.23	49.55	47.95	46.65
55.00	45.80	45.00	44.21	43.45	42.73
60.00	42.04	41.39	40.75	40.19	39.67
65.00	39.12	38.58	38.06	37.56	37.07
70.00	36.60	36.20	35.81	35.42	35.04
75.00	34.67	34.31	33.95	33.60	33.29
80.00	32.98	32.64	32.32	32.00	31.68
85.00	31.35	31.05	30.74	30.45	30.16
90.00	29.87	29.57	29.28	28.99	28.72
95.00	28.45	28.18	27.80	27.44	27.08
100.00	26.74	26.40	26.08	25.76	25.49
105.00	25.22	24.94	24.68	24.43	24.17
110.00	23.92	23.55	23.18	22.82	22.48
115.00	22.14	21.82	21.50	21.19	20.90
120.00	20.68	20.45	20.25	20.03	19.82
125.00	19.61	19.41	19.21	19.02	18.83
130.00	18.65	18.45	18.28	18.10	17.94
135.00	17.77	17.60	17.43	17.28	17.11
140.00	16.96	16.81	16.65	16.50	16.36
145.00	16.20	16.04	15.88	15.72	15.56
150.00	15.42	15.26	15.11	14.97	14.84
155.00	14.70	14.56	14.42	14.29	14.13
160.00	13.95	13.77	13.59	13.43	13.27

HYDROGRAPH ORDINATES (cfs)
Output Time increment = 1.00 min
Time on left represents time for first value in each row.

Time min					
165.00	13.12	12.97	12.83	12.69	12.56
170.00	12.44	12.32	12.20	12.07	11.94
175.00	11.82	11.69	11.58	11.48	11.38
180.00	11.27	11.18	11.07	10.99	10.90
185.00	10.81	10.72	10.63	10.57	10.48
190.00	10.38	10.30	10.21	10.13	10.07
195.00	9.99	9.92	9.85	9.77	9.71
200.00	9.64	9.57	9.51	9.44	9.38
205.00	9.32	9.25	9.18	9.13	9.07
210.00	9.02	8.95	8.90	8.84	8.79
215.00	8.72	8.67	8.61	8.56	8.49
220.00	8.44	8.39	8.34	8.28	8.23
225.00	8.17	8.12	8.06	8.01	7.96
230.00	7.91	7.86	7.80	7.75	7.70
235.00	7.65	7.61	7.55	7.50	7.45
240.00	7.40	7.35	7.30	7.25	7.21
245.00	7.05	6.89	6.84	6.79	6.75
250.00	6.71	6.66	6.62	6.48	6.44
255.00	6.39	6.35	6.31	6.27	6.23
260.00	6.19	6.15	6.11	6.07	6.03
265.00	5.99	5.95	5.91	5.87	5.83
270.00	5.79	5.75	5.71	5.67	5.64
275.00	5.60	5.56	5.52	5.49	5.45
280.00	5.42	5.38	5.35	5.31	5.27
285.00	5.23	5.20	5.16	5.13	5.10
290.00	5.07	5.03	5.00	4.96	4.93
295.00	4.90	4.87	4.83	4.80	4.77
300.00	4.74	4.70	4.67	4.64	4.61
305.00	4.58	4.55	4.52	4.49	4.46
310.00	4.43	4.40	4.37	4.34	4.31
315.00	4.28	4.25	4.22	4.19	4.16
320.00	4.13	4.10	4.08	4.05	4.02
325.00	3.99	3.97	3.94	3.92	3.89
330.00	3.86	3.83	3.81	3.78	3.76
335.00	3.73	3.71	3.68	3.66	3.63
340.00	3.61	3.58	3.56	3.53	3.51
345.00	3.48	3.46	3.43	3.41	3.39
350.00	3.37	3.34	3.32	3.29	3.27
355.00	3.25	3.23	3.20	3.18	3.16
360.00	3.14	3.12	3.10	3.07	3.05
365.00	3.03	3.01	2.99	2.97	2.95
370.00	2.93	2.91	2.89	2.87	2.85
375.00	2.83	2.81	2.79	2.77	2.75
380.00	2.73	2.71	2.69	2.67	2.66
385.00	2.64	2.62	2.60	2.58	2.56
390.00	2.55	2.53	2.51	2.49	2.48
395.00	2.46	2.44	2.42	2.41	2.39

Type.... Node: Pond Inflow Summary

Page 4.12

Name.... PENNIAL LAKE IN

Event: C 100YR

File..... C:\MY DOCUMENTS\PENNIAL PARK LAKE DETENTION.PPW

Storm... C 100YR Tag: C 100Y

HYDROGRAPH ORDINATES (cfs)
Output Time increment = 1.00 min
Time on left represents time for first value in each row.

Time min		
400.00	2.38	.00

S/N: f21101d06a84 Bax Engineering

PondPack Ver: 7.0 (325)

Compute Time: 12:52:05

Date: 08-12-2002

Type.... Pond Routing Summary
Name.... PENNIAL LAKE OUT Tag: A 15YR
File.... C:\MY DOCUMENTS\PENNIAL PARK LAKE DETENTION.PPW
Storm... A 15YR Tag: A 15YR

Page 4.13
Event: A 15YR

LEVEL POOL ROUTING SUMMARY

HYG Dir = C:\MY DOCUMENTS\
Inflow HYG file = NONE STORED - PENNIAL LAKE IN A 15YR
Outflow HYG file = NONE STORED - PENNIAL LAKE OUT A 15YR

Pond Node Data = PENNIAL LAKE
Pond Volume Data = PENNIAL LAKE
Pond Outlet Data = TRIPLE BOX W/BOX

No Infiltration

INITIAL CONDITIONS

Starting WS Elev = 516.00 ft
Starting Volume = 0 cu.ft
Starting Outflow = .00 cfs
Starting Infiltr. = .00 cfs
Starting Total Qout = .00 cfs
Time Increment = 1.00 min

INFLOW/OUTFLOW HYDROGRAPH SUMMARY

=====
Peak Inflow = 322.36 cfs at 20.00 min
Peak Outflow = 171.13 cfs at 26.00 min

Peak Elevation = 519.58 ft
Peak Storage = 244123 cu.ft
=====

MASS BALANCE (cu.ft)

+ Initial Vol = 0
+ HYG Vol IN = 637548
- Infiltration = 0
- HYG Vol OUT = 637529
- Retained Vol = 19

Unrouted Vol = - cu.ft (.000% of Inflow Volume)

Type... Pond Routed HYG (total out)
 Name... PENNIAL LAKE OUT Tag: A 15YR
 File... C:\MY DOCUMENTS\PENNIAL PARK LAKE DETENTION.PPW
 Storm... A 15YR Tag: A 15YR

Page 4.14
 Event: A 15YR

POND ROUTED TOTAL OUTFLOW HYG...

HYG file =
 HYG ID = PENNIAL LAKE OUT
 HYG Tag = A 15YR

 Peak Discharge = 171.13 cfs
 Time to Peak = 26.00 min
 HYG Volume = 637529 cu.ft

HYDROGRAPH ORDINATES (cfs)

Output Time increment = 1.00 min
 Time on left represents time for first value in each row.

Time min					
.00	.00	.14	.55	1.49	3.38
5.00	6.47	10.94	17.03	24.85	34.24
10.00	42.97	51.18	59.14	66.84	74.69
15.00	82.16	90.94	104.62	115.29	132.86
20.00	157.62	162.06	165.08	167.73	169.57
25.00	170.67	171.13	170.87	169.88	168.05
30.00	165.54	163.16	160.59	157.61	152.62
35.00	130.80	122.60	120.71	112.60	104.65
40.00	104.31	104.78	100.33	94.50	91.09
45.00	91.00	90.91	88.91	86.60	84.53
50.00	83.05	81.60	80.18	78.79	77.42
55.00	76.12	74.88	73.66	72.36	71.03
60.00	69.73	68.49	67.32	66.17	65.05
65.00	63.94	62.85	61.79	60.78	59.81
70.00	58.86	57.93	56.96	55.98	55.01
75.00	54.07	53.18	52.34	51.51	50.70
80.00	49.90	49.07	48.25	47.45	46.67
85.00	45.90	45.16	44.44	43.73	43.03
90.00	42.34	41.64	40.95	40.27	39.61
95.00	38.96	38.32	37.67	37.03	36.40
100.00	35.78	35.17	34.57	33.94	33.30
105.00	32.68	32.07	31.47	30.89	30.32
110.00	29.77	29.22	28.70	28.18	27.67
115.00	27.18	26.70	26.23	25.77	25.33
120.00	24.92	24.51	24.11	23.72	23.34
125.00	22.96	22.59	22.24	21.89	21.54
130.00	21.22	20.91	20.60	20.30	20.00
135.00	19.71	19.42	19.14	18.86	18.59
140.00	18.32	18.06	17.80	17.55	17.32
145.00	17.08	16.85	16.62	16.39	16.17
150.00	15.95	15.73	15.51	15.30	15.09
155.00	14.88	14.67	14.47	14.27	14.07
160.00	13.88	13.71	13.53	13.36	13.19

Type.... Pond Routed HYG (total out)
 Name.... PENNIAL LAKE OUT Tag: A 15YR
 File.... C:\MY DOCUMENTS\PENNIAL PARK LAKE DETENTION.PPW
 Storm... A 15YR Tag: A 15YR

Page 4.15
 Event: A 15YR

HYDROGRAPH ORDINATES (cfs)						
Time	Output Time increment = 1.00 min					
min	Time on left represents time for first value in each row.					
165.00	13.02	12.86	12.70	12.54	12.38	
170.00	12.22	12.07	11.92	11.78	11.63	
175.00	11.49	11.35	11.21	11.07	10.94	
180.00	10.81	10.68	10.56	10.45	10.34	
185.00	10.23	10.12	10.01	9.91	9.81	
190.00	9.71	9.61	9.51	9.42	9.32	
195.00	9.23	9.14	9.05	8.96	8.88	
200.00	8.79	8.71	8.62	8.54	8.46	
205.00	8.39	8.31	8.23	8.15	8.08	
210.00	8.01	7.93	7.86	7.79	7.72	
215.00	7.65	7.59	7.53	7.47	7.41	
220.00	7.35	7.29	7.24	7.18	7.13	
225.00	7.07	7.02	6.96	6.91	6.86	
230.00	6.80	6.75	6.70	6.65	6.60	
235.00	6.55	6.50	6.45	6.40	6.35	
240.00	6.30	6.26	6.21	6.16	6.12	
245.00	6.07	6.03	5.98	5.94	5.89	
250.00	5.85	5.80	5.76	5.72	5.68	
255.00	5.63	5.59	5.55	5.51	5.46	
260.00	5.42	5.38	5.34	5.29	5.25	
265.00	5.21	5.17	5.13	5.09	5.05	
270.00	5.02	4.98	4.94	4.91	4.87	
275.00	4.84	4.81	4.78	4.75	4.72	
280.00	4.69	4.66	4.63	4.60	4.57	
285.00	4.54	4.51	4.48	4.45	4.42	
290.00	4.39	4.36	4.33	4.30	4.28	
295.00	4.25	4.22	4.19	4.16	4.14	
300.00	4.11	4.08	4.06	4.03	4.00	
305.00	3.98	3.95	3.92	3.90	3.87	
310.00	3.85	3.82	3.79	3.77	3.74	
315.00	3.72	3.69	3.67	3.64	3.62	
320.00	3.60	3.57	3.55	3.52	3.50	
325.00	3.48	3.45	3.43	3.41	3.38	
330.00	3.36	3.34	3.32	3.29	3.27	
335.00	3.25	3.23	3.21	3.18	3.16	
340.00	3.14	3.12	3.10	3.08	3.06	
345.00	3.04	3.02	2.99	2.97	2.95	
350.00	2.93	2.91	2.89	2.87	2.85	
355.00	2.84	2.82	2.80	2.78	2.76	
360.00	2.74	2.72	2.70	2.68	2.67	
365.00	2.66	2.64	2.63	2.61	2.60	
370.00	2.58	2.57	2.56	2.54	2.53	
375.00	2.51	2.50	2.49	2.47	2.46	
380.00	2.44	2.43	2.42	2.40	2.39	
385.00	2.38	2.36	2.35	2.34	2.32	
390.00	2.31	2.29	2.28	2.27	2.26	
395.00	2.24	2.23	2.22	2.20	2.19	

HYDROGRAPH ORDINATES (cfs)
Output Time increment = 1.00 min
Time on left represents time for first value in each row.

Time min					
400.00	2.18	2.15	2.12	2.08	2.05
405.00	2.02	1.98	1.95	1.92	1.89
410.00	1.86	1.83	1.80	1.77	1.74
415.00	1.71	1.68	1.65	1.63	1.60
420.00	1.57	1.55	1.52	1.50	1.47
425.00	1.45	1.42	1.40	1.38	1.36
430.00	1.33	1.31	1.29	1.27	1.25
435.00	1.23	1.21	1.19	1.17	1.15
440.00	1.13	1.11	1.09	1.08	1.06
445.00	1.04	1.02	1.01	.99	.97
450.00	.96	.94	.94	.93	.92
455.00	.91	.90	.89	.89	.88
460.00	.87	.86	.86	.85	.84
465.00	.83	.82	.82	.81	.80
470.00	.80	.79	.78	.77	.77
475.00	.76	.75	.75	.74	.73
480.00	.73	.72	.71	.71	.70
485.00	.69	.69	.68	.68	.67
490.00	.66	.66	.65	.65	.64
495.00	.63	.63	.62	.62	.61
500.00	.61	.60	.59	.59	.58
505.00	.58	.57	.57	.56	.56
510.00	.55	.55	.54	.54	.53
515.00	.53	.52	.52	.51	.51
520.00	.50	.50	.50	.49	.49
525.00	.48	.48	.47	.47	.47
530.00	.46	.46	.45	.45	.44
535.00	.44	.44	.43	.43	.42
540.00	.42	.42	.41	.41	.41
545.00	.40	.40	.40	.39	.39
550.00	.38	.38	.38	.37	.37
555.00	.37	.36	.36	.36	.35
560.00	.35	.35	.34	.34	.34
565.00	.34	.33	.33	.33	.32
570.00	.32	.32	.31	.31	.31
575.00	.31	.30	.30	.30	.30
580.00	.29	.29	.29	.28	.28
585.00	.28	.28	.27	.27	.27
590.00	.27	.26	.26	.26	.26
595.00	.26	.25	.25	.25	.25
600.00	.24	.24	.24	.24	.24
605.00	.23	.23	.23	.23	.22
610.00	.22	.22	.22	.22	.22
615.00	.21	.21	.21	.21	.21
620.00	.20	.20	.20	.20	.20
625.00	.19	.19	.19	.19	.19
630.00	.19	.18	.18	.18	.18

Type.... Pond Routed HYG (total out)
 Name.... PENNIAL LAKE OUT Tag: A 15YR
 File.... C:\MY DOCUMENTS\PENNIAL PARK LAKE DETENTION.PPW
 Storm... A 15YR Tag: A 15YR

Page 4.17
 Event: A 15YR

HYDROGRAPH ORDINATES (cfs)						
Time min	Output Time increment = 1.00 min					
	Time on left represents time for first value in each row.					
635.00	.18	.18	.17	.17	.17	.17
640.00	.17	.17	.17	.17	.17	.16
645.00	.16	.16	.16	.16	.16	.16
650.00	.16	.15	.15	.15	.15	.15
655.00	.15	.15	.15	.14	.14	.14
660.00	.14	.14	.14	.14	.14	.14
665.00	.14	.13	.13	.13	.13	.13
670.00	.13	.13	.13	.13	.13	.12
675.00	.12	.12	.12	.12	.12	.12
680.00	.12	.12	.12	.11	.11	.11
685.00	.11	.11	.11	.11	.11	.11
690.00	.11	.11	.11	.10	.10	.10
695.00	.10	.10	.10	.10	.10	.10
700.00	.10	.10	.10	.10	.10	.09
705.00	.09	.09	.09	.09	.09	.09
710.00	.09	.09	.09	.09	.09	.09
715.00	.09	.09	.08	.08	.08	.08
720.00	.08	.08	.08	.08	.08	.08
725.00	.08	.08	.08	.08	.08	.08
730.00	.07	.07	.07	.07	.07	.07
735.00	.07	.07	.07	.07	.07	.07
740.00	.07	.07	.07	.07	.07	.07
745.00	.07	.06	.06	.06	.06	.06
750.00	.06	.06	.06	.06	.06	.06
755.00	.06	.06	.06	.06	.06	.06
760.00	.06	.06	.06	.06	.06	.06
765.00	.05	.05	.05	.05	.05	.05
770.00	.05	.05	.05	.05	.05	.05
775.00	.05	.05	.05	.05	.05	.05
780.00	.05	.05	.05	.05	.05	.05
785.00	.05	.05	.04	.04	.04	.04
790.00	.04	.04	.04	.04	.04	.04
795.00	.04	.04	.04	.04	.04	.04
800.00	.04	.04	.04	.04	.04	.04
805.00	.04	.04	.04	.04	.04	.04
810.00	.04	.04	.04	.04	.04	.03
815.00	.03	.03	.03	.03	.03	.03
820.00	.03	.03	.03	.03	.03	.03
825.00	.03	.03	.03	.03	.03	.03
830.00	.03	.03	.03	.03	.03	.03
835.00	.03	.03	.03	.03	.03	.03
840.00	.03	.03	.03	.03	.03	.03
845.00	.03	.03	.03	.03	.03	.03
850.00	.03	.02	.02	.02	.02	.02
855.00	.02	.02	.02	.02	.02	.02
860.00	.02	.02	.02	.02	.02	.02
865.00	.02	.02	.02	.02	.02	.02

Type.... Pond Routed HYG (total out)
 Name.... PENNIAL LAKE OUT Tag: A 15YR
 File.... C:\MY DOCUMENTS\PENNIAL PARK LAKE DETENTION.PPW
 Storm... A 15YR Tag: A 15YR

HYDROGRAPH ORDINATES (cfs)
 Output Time increment = 1.00 min
 Time on left represents time for first value in each row.

Time min					
870.00	.02	.02	.02	.02	.02
875.00	.02	.02	.02	.02	.02
880.00	.02	.02	.02	.02	.02
885.00	.02	.02	.02	.02	.02
890.00	.02	.02	.02	.02	.02
895.00	.02	.02	.02	.02	.02
900.00	.02	.02	.02	.02	.02
905.00	.02	.02	.02	.01	.01
910.00	.01	.01	.01	.01	.01
915.00	.01	.01	.01	.01	.01
920.00	.01	.01	.01	.01	.01
925.00	.01	.01	.01	.01	.01
930.00	.01	.01	.01	.01	.01
935.00	.01	.01	.01	.01	.01
940.00	.01	.01	.01	.01	.01
945.00	.01	.01	.01	.01	.01
950.00	.01	.01	.01	.01	.01
955.00	.01	.01	.01	.01	.01
960.00	.01	.01	.01	.01	.01
965.00	.01	.01	.01	.01	.01
970.00	.01	.01	.01	.01	.01
975.00	.01	.01	.01	.01	.01
980.00	.01	.01	.01	.01	.01
985.00	.01	.01	.01	.01	.01
990.00	.01	.01	.01	.01	.01
995.00	.01	.01	.01	.01	.01
1000.00	.01	.01	.01	.01	.01
1005.00	.01	.01	.01	.01	.01
1010.00	.01	.01	.01	.01	.01
1015.00	.01	.01	.01	.01	.01
1020.00	.01	.01	.01	.01	.01
1025.00	.01	.01	.01	.01	.00
1030.00	.00	.00	.00	.00	.00
1035.00	.00	.00	.00	.00	.00
1040.00	.00	.00	.00	.00	.00
1045.00	.00	.00	.00	.00	.00
1050.00	.00	.00	.00	.00	.00
1055.00	.00	.00	.00	.00	.00
1060.00	.00	.00	.00	.00	.00
1065.00	.00	.00	.00	.00	.00
1070.00	.00	.00	.00	.00	.00
1075.00	.00	.00	.00	.00	.00
1080.00	.00	.00	.00	.00	.00
1085.00	.00				

Type.... Pond Routing Summary
Name.... PENNIAL LAKE OUT Tag: B 25YR
File.... C:\MY DOCUMENTS\PENNIAL PARK LAKE DETENTION.PPW
Storm... B 25YR Tag: B 25YR

Page 4.19
Event: B 25YR

LEVEL POOL ROUTING SUMMARY

HYG Dir = C:\MY DOCUMENTS\
Inflow HYG file = NONE STORED - PENNIAL LAKE IN B 25YR
Outflow HYG file = NONE STORED - PENNIAL LAKE OUT B 25YR

Pond Node Data = PENNIAL LAKE
Pond Volume Data = PENNIAL LAKE
Pond Outlet Data = TRIPLE BOX W/BOX

No Infiltration

INITIAL CONDITIONS

Starting WS Elev = 516.00 ft
Starting Volume = 0 cu.ft
Starting Outflow = .00 cfs
Starting Infiltr. = .00 cfs
Starting Total Qout = .00 cfs
Time Increment = 1.00 min

INFLOW/OUTFLOW HYDROGRAPH SUMMARY

=====
Peak Inflow = 375.36 cfs at 20.00 min
Peak Outflow = 186.28 cfs at 25.00 min

Peak Elevation = 520.12 ft
Peak Storage = 284237 cu.ft
=====

MASS BALANCE (cu.ft)

+ Initial Vol = 0
+ HYG Vol IN = 882941
- Infiltration = 0
- HYG Vol OUT = 882921
- Retained Vol = 19

Unrouted Vol = -1 cu.ft (.000% of Inflow Volume)

Type... Pond Routed HYG (total out)
 Name... PENNIAL LAKE OUT Tag: B 25YR
 File... C:\MY DOCUMENTS\PENNIAL PARK LAKE DETENTION.PPW
 Storm... B 25YR Tag: B 25YR

POND ROUTED TOTAL OUTFLOW HYG...

HYG file =
 HYG ID = PENNIAL LAKE OUT
 HYG Tag = B 25YR

 Peak Discharge = 186.28 cfs
 Time to Peak = 25.00 min
 HYG Volume = 882921 cu.ft

HYDROGRAPH ORDINATES (cfs)

Output Time increment = 1.00 min
 Time on left represents time for first value in each row.

Time min					
.00	.00	.17	.69	2.02	4.59
5.00	8.80	14.87	23.07	33.35	43.64
10.00	53.77	63.65	73.55	82.81	91.08
15.00	104.00	126.15	158.36	164.03	169.50
20.00	174.15	178.15	181.70	184.12	185.58
25.00	186.28	186.22	185.42	183.90	181.50
30.00	178.58	175.94	173.75	171.69	169.55
35.00	167.48	165.50	163.86	162.39	160.89
40.00	159.46	157.98	156.40	154.88	147.87
45.00	139.90	133.62	128.47	124.07	123.40
50.00	122.88	122.29	121.62	120.87	118.29
55.00	114.17	110.04	105.91	104.04	104.33
60.00	104.65	103.66	98.88	94.40	91.11
65.00	91.04	90.97	90.90	89.03	87.18
70.00	85.38	84.04	82.88	81.73	80.60
75.00	79.49	78.39	77.30	76.27	75.28
80.00	74.29	73.32	72.25	71.18	70.12
85.00	69.08	68.12	67.18	66.24	65.32
90.00	64.41	63.51	62.62	61.74	60.89
95.00	60.08	59.27	58.48	57.69	56.84
100.00	56.00	55.17	54.35	53.55	52.81
105.00	52.08	51.35	50.63	49.91	49.16
110.00	48.42	47.69	46.97	46.25	45.57
115.00	44.90	44.24	43.59	42.94	42.30
120.00	41.65	41.00	40.37	39.74	39.13
125.00	38.53	37.93	37.33	36.75	36.18
130.00	35.61	35.06	34.52	33.95	33.38
135.00	32.82	32.27	31.73	31.21	30.69
140.00	30.19	29.70	29.21	28.74	28.28
145.00	27.82	27.38	26.94	26.51	26.09
150.00	25.68	25.30	24.92	24.55	24.19
155.00	23.83	23.47	23.13	22.78	22.44
160.00	22.11	21.78	21.45	21.15	20.85

Type.... Pond Routed HYG (total out)
 Name.... PENNIAL LAKE OUT Tag: B 25YR
 File..... C:\MY DOCUMENTS\PENNIAL PARK LAKE DETENTION.PPW
 Storm... B 25YR Tag: B 25YR

Page 4.21
 Event: B 25YR

HYDROGRAPH ORDINATES (cfs)						
Time min	Output Time increment = 1.00 min					
	Time on left represents time for first value in each row.					
165.00	20.56	20.27	19.99	19.71	19.43	
170.00	19.16	18.90	18.63	18.37	18.12	
175.00	17.87	17.62	17.40	17.17	16.95	
180.00	16.74	16.53	16.32	16.11	15.91	
185.00	15.71	15.51	15.32	15.13	14.94	
190.00	14.76	14.58	14.40	14.23	14.06	
195.00	13.89	13.74	13.59	13.44	13.30	
200.00	13.15	13.01	12.87	12.73	12.60	
205.00	12.47	12.33	12.20	12.08	11.95	
210.00	11.83	11.71	11.59	11.47	11.35	
215.00	11.24	11.12	11.01	10.90	10.79	
220.00	10.68	10.58	10.49	10.39	10.30	
225.00	10.21	10.11	10.02	9.94	9.85	
230.00	9.76	9.67	9.59	9.50	9.42	
235.00	9.34	9.26	9.18	9.10	9.02	
240.00	8.94	8.86	8.79	8.71	8.64	
245.00	8.56	8.49	8.42	8.35	8.27	
250.00	8.20	8.14	8.07	8.00	7.93	
255.00	7.87	7.80	7.74	7.68	7.61	
260.00	7.55	7.50	7.45	7.39	7.34	
265.00	7.28	7.23	7.18	7.12	7.07	
270.00	7.02	6.97	6.92	6.87	6.82	
275.00	6.77	6.72	6.67	6.62	6.57	
280.00	6.52	6.47	6.42	6.38	6.33	
285.00	6.28	6.24	6.19	6.14	6.10	
290.00	6.05	6.01	5.96	5.92	5.88	
295.00	5.83	5.79	5.75	5.70	5.66	
300.00	5.62	5.57	5.52	5.47	5.42	
305.00	5.37	5.32	5.27	5.22	5.17	
310.00	5.12	5.08	5.03	4.99	4.94	
315.00	4.90	4.86	4.83	4.79	4.75	
320.00	4.72	4.68	4.65	4.61	4.58	
325.00	4.54	4.51	4.48	4.44	4.41	
330.00	4.38	4.34	4.31	4.28	4.25	
335.00	4.21	4.18	4.15	4.12	4.09	
340.00	4.06	4.03	4.00	3.97	3.94	
345.00	3.91	3.88	3.86	3.83	3.80	
350.00	3.77	3.74	3.72	3.69	3.66	
355.00	3.63	3.61	3.58	3.55	3.53	
360.00	3.50	3.48	3.45	3.43	3.40	
365.00	3.38	3.35	3.33	3.30	3.28	
370.00	3.26	3.23	3.21	3.19	3.16	
375.00	3.14	3.12	3.09	3.07	3.05	
380.00	3.03	3.00	2.98	2.96	2.94	
385.00	2.92	2.90	2.88	2.86	2.84	
390.00	2.81	2.79	2.77	2.75	2.73	
395.00	2.72	2.70	2.68	2.66	2.65	

S/N: f21101d06a84 Bax Engineering
 PondPack Ver: 7.0 (325) Compute Time: 12:52:05 Date: 08-12-2002

Type... Pond Routed HYG (total out)
 Name... PENNIAL LAKE OUT Tag: B 25YR
 File... C:\MY DOCUMENTS\PENNIAL PARK LAKE DETENTION.PPW
 Storm... B 25YR Tag: B 25YR

Page 4.22
 Event: B 25YR

HYDROGRAPH ORDINATES (cfs)
 Output Time increment = 1.00 min
 Time on left represents time for first value in each row.

Time min					
400.00	2.63	2.60	2.56	2.52	2.48
405.00	2.44	2.40	2.36	2.32	2.28
410.00	2.24	2.21	2.17	2.14	2.10
415.00	2.07	2.03	2.00	1.97	1.93
420.00	1.90	1.87	1.84	1.81	1.78
425.00	1.75	1.72	1.69	1.67	1.64
430.00	1.61	1.59	1.56	1.53	1.51
435.00	1.48	1.46	1.44	1.41	1.39
440.00	1.37	1.34	1.32	1.30	1.28
445.00	1.26	1.24	1.22	1.20	1.18
450.00	1.16	1.14	1.12	1.10	1.08
455.00	1.07	1.05	1.03	1.02	1.00
460.00	.98	.97	.95	.94	.93
465.00	.92	.92	.91	.90	.89
470.00	.88	.87	.87	.86	.85
475.00	.84	.84	.83	.82	.81
480.00	.81	.80	.79	.78	.78
485.00	.77	.76	.76	.75	.74
490.00	.74	.73	.72	.72	.71
495.00	.70	.70	.69	.68	.68
500.00	.67	.67	.66	.65	.65
505.00	.64	.64	.63	.63	.62
510.00	.61	.61	.60	.60	.59
515.00	.59	.58	.58	.57	.57
520.00	.56	.56	.55	.55	.54
525.00	.54	.53	.53	.52	.52
530.00	.51	.51	.50	.50	.49
535.00	.49	.48	.48	.48	.47
540.00	.47	.46	.46	.45	.45
545.00	.45	.44	.44	.43	.43
550.00	.43	.42	.42	.42	.41
555.00	.41	.40	.40	.40	.39
560.00	.39	.39	.38	.38	.38
565.00	.37	.37	.37	.36	.36
570.00	.36	.35	.35	.35	.34
575.00	.34	.34	.33	.33	.33
580.00	.33	.32	.32	.32	.31
585.00	.31	.31	.31	.30	.30
590.00	.30	.29	.29	.29	.29
595.00	.28	.28	.28	.28	.27
600.00	.27	.27	.27	.26	.26
605.00	.26	.26	.25	.25	.25
610.00	.25	.25	.24	.24	.24
615.00	.24	.23	.23	.23	.23
620.00	.23	.22	.22	.22	.22
625.00	.22	.21	.21	.21	.21
630.00	.21	.20	.20	.20	.20

Type.... Pond Routed HYG (total out)
 Name.... PENNIAL LAKE OUT Tag: B 25YR
 File.... C:\MY DOCUMENTS\PENNIAL PARK LAKE DETENTION.PPW
 Storm... B 25YR Tag: B 25YR

Page 4.23
 Event: B 25YR

HYDROGRAPH ORDINATES (cfs)						
Time min	Output Time increment = 1.00 min					
	Time on left represents time for first value in each row.					
635.00	.20	.20	.19	.19	.19	.19
640.00	.19	.19	.19	.18	.18	.18
645.00	.18	.18	.18	.18	.17	.17
650.00	.17	.17	.17	.17	.17	.17
655.00	.16	.16	.16	.16	.16	.16
660.00	.16	.16	.15	.15	.15	.15
665.00	.15	.15	.15	.15	.14	.14
670.00	.14	.14	.14	.14	.14	.14
675.00	.14	.14	.13	.13	.13	.13
680.00	.13	.13	.13	.13	.13	.13
685.00	.13	.12	.12	.12	.12	.12
690.00	.12	.12	.12	.12	.12	.12
695.00	.11	.11	.11	.11	.11	.11
700.00	.11	.11	.11	.11	.11	.11
705.00	.10	.10	.10	.10	.10	.10
710.00	.10	.10	.10	.10	.10	.10
715.00	.10	.09	.09	.09	.09	.09
720.00	.09	.09	.09	.09	.09	.09
725.00	.09	.09	.09	.08	.08	.08
730.00	.08	.08	.08	.08	.08	.08
735.00	.08	.08	.08	.08	.08	.08
740.00	.08	.08	.07	.07	.07	.07
745.00	.07	.07	.07	.07	.07	.07
750.00	.07	.07	.07	.07	.07	.07
755.00	.07	.07	.07	.06	.06	.06
760.00	.06	.06	.06	.06	.06	.06
765.00	.06	.06	.06	.06	.06	.06
770.00	.06	.06	.06	.06	.06	.06
775.00	.06	.05	.05	.05	.05	.05
780.00	.05	.05	.05	.05	.05	.05
785.00	.05	.05	.05	.05	.05	.05
790.00	.05	.05	.05	.05	.05	.05
795.00	.05	.05	.05	.04	.04	.04
800.00	.04	.04	.04	.04	.04	.04
805.00	.04	.04	.04	.04	.04	.04
810.00	.04	.04	.04	.04	.04	.04
815.00	.04	.04	.04	.04	.04	.04
820.00	.04	.04	.04	.04	.04	.04
825.00	.04	.03	.03	.03	.03	.03
830.00	.03	.03	.03	.03	.03	.03
835.00	.03	.03	.03	.03	.03	.03
840.00	.03	.03	.03	.03	.03	.03
845.00	.03	.03	.03	.03	.03	.03
850.00	.03	.03	.03	.03	.03	.03
855.00	.03	.03	.03	.03	.03	.03
860.00	.03	.03	.03	.02	.02	.02
865.00	.02	.02	.02	.02	.02	.02

Type.... Pond Routed HYG (total out)
 Name.... PENNIAL LAKE OUT Tag: B 25YR
 File.... C:\MY DOCUMENTS\PENNIAL PARK LAKE DETENTION.PPW
 Storm... B 25YR Tag: B 25YR

HYDROGRAPH ORDINATES (cfs)
 Output Time increment = 1.00 min
 Time on left represents time for first value in each row.

Time min					
870.00	.02	.02	.02	.02	.02
875.00	.02	.02	.02	.02	.02
880.00	.02	.02	.02	.02	.02
885.00	.02	.02	.02	.02	.02
890.00	.02	.02	.02	.02	.02
895.00	.02	.02	.02	.02	.02
900.00	.02	.02	.02	.02	.02
905.00	.02	.02	.02	.02	.02
910.00	.02	.02	.02	.02	.02
915.00	.02	.02	.02	.02	.01
920.00	.01	.01	.01	.01	.01
925.00	.01	.01	.01	.01	.01
930.00	.01	.01	.01	.01	.01
935.00	.01	.01	.01	.01	.01
940.00	.01	.01	.01	.01	.01
945.00	.01	.01	.01	.01	.01
950.00	.01	.01	.01	.01	.01
955.00	.01	.01	.01	.01	.01
960.00	.01	.01	.01	.01	.01
965.00	.01	.01	.01	.01	.01
970.00	.01	.01	.01	.01	.01
975.00	.01	.01	.01	.01	.01
980.00	.01	.01	.01	.01	.01
985.00	.01	.01	.01	.01	.01
990.00	.01	.01	.01	.01	.01
995.00	.01	.01	.01	.01	.01
1000.00	.01	.01	.01	.01	.01
1005.00	.01	.01	.01	.01	.01
1010.00	.01	.01	.01	.01	.01
1015.00	.01	.01	.01	.01	.01
1020.00	.01	.01	.01	.01	.01
1025.00	.01	.01	.01	.01	.01
1030.00	.01	.01	.01	.01	.01
1035.00	.01	.01	.01	.01	.01
1040.00	.00	.00	.00	.00	.00
1045.00	.00	.00	.00	.00	.00
1050.00	.00	.00	.00	.00	.00
1055.00	.00	.00	.00	.00	.00
1060.00	.00	.00	.00	.00	.00
1065.00	.00	.00	.00	.00	.00
1070.00	.00	.00	.00	.00	.00
1075.00	.00	.00	.00	.00	.00
1080.00	.00	.00	.00	.00	.00
1085.00	.00	.00	.00	.00	.00
1090.00	.00	.00	.00	.00	.00
1095.00	.00	.00	.00	.00	.00

Type.... Pond Routing Summary
Name.... PENNIAL LAKE OUT Tag: C 100Y
File.... C:\MY DOCUMENTS\PENNIAL PARK LAKE DETENTION.PPW
Storm... C 100YR Tag: C 100Y

Page 4.25
Event: C 100YR

LEVEL POOL ROUTING SUMMARY

HYG Dir = C:\MY DOCUMENTS\
Inflow HYG file = NONE STORED - PENNIAL LAKE IN C 100Y
Outflow HYG file = NONE STORED - PENNIAL LAKE OUT C 100Y

Pond Node Data = PENNIAL LAKE
Pond Volume Data = PENNIAL LAKE
Pond Outlet Data = TRIPLE BOX W/BOX

No Infiltration

INITIAL CONDITIONS

Starting WS Elev = 516.00 ft
Starting Volume = 0 cu.ft
Starting Outflow = .00 cfs
Starting Infiltr. = .00 cfs
Starting Total Qout = .00 cfs
Time Increment = 1.00 min

INFLOW/OUTFLOW HYDROGRAPH SUMMARY

=====
Peak Inflow = 548.82 cfs at 20.00 min
Peak Outflow = 227.53 cfs at 28.00 min

Peak Elevation = 521.77 ft
Peak Storage = 414120 cu.ft
=====

MASS BALANCE (cu.ft)

+ Initial Vol = 0
+ HYG Vol IN = 1016135
- Infiltration = 0
- HYG Vol OUT = 1016115
- Retained Vol = 19

Unrouted Vol = - cu.ft (.000% of Inflow Volume)

Type.... Pond Routed HYG (total out)
 Name.... PENNIAL LAKE OUT Tag: C 100Y
 File.... C:\MY DOCUMENTS\PENNIAL PARK LAKE DETENTION.PPW
 Storm... C 100YR Tag: C 100Y

Page 4.26
 Event: C 100YR

POND ROUTED TOTAL OUTFLOW HYG...

HYG file =
 HYG ID = PENNIAL LAKE OUT
 HYG Tag = C 100Y

 Peak Discharge = 227.53 cfs
 Time to Peak = 28.00 min
 HYG Volume = 1016115 cu.ft

HYDROGRAPH ORDINATES (cfs)

Output Time increment = 1.00 min
 Time on left represents time for first value in each row.

Time min					
.00	.00	.22	.88	2.83	6.60
5.00	12.60	21.22	32.69	44.53	57.09
10.00	70.00	82.86	99.77	122.50	159.83
15.00	168.26	175.44	182.99	190.12	197.24
20.00	204.01	210.10	215.27	219.22	222.38
25.00	224.80	226.50	227.43	227.53	226.77
30.00	225.43	223.90	222.23	220.41	218.48
35.00	216.48	214.45	212.11	210.04	207.79
40.00	205.63	203.46	201.04	198.65	196.37
45.00	193.51	191.17	188.16	185.48	182.73
50.00	179.62	176.54	173.92	171.18	168.09
55.00	164.77	161.78	158.46	154.49	129.69
60.00	122.16	117.84	107.85	104.22	104.76
65.00	99.55	92.86	91.05	90.95	89.49
70.00	86.86	84.51	82.87	81.27	79.72
75.00	78.21	76.75	75.40	74.09	72.75
80.00	71.34	69.97	68.66	67.44	66.25
85.00	65.09	63.95	62.85	61.77	60.75
90.00	59.78	58.83	57.90	56.93	55.95
95.00	55.00	54.08	53.20	52.37	51.56
100.00	50.76	49.98	49.16	48.37	47.59
105.00	46.82	46.08	45.37	44.68	44.00
110.00	43.34	42.69	42.04	41.38	40.72
115.00	40.08	39.46	38.84	38.23	37.61
120.00	37.02	36.43	35.86	35.30	34.75
125.00	34.20	33.62	33.06	32.51	31.98
130.00	31.46	30.95	30.45	29.97	29.50
135.00	29.04	28.59	28.16	27.73	27.32
140.00	26.91	26.52	26.13	25.75	25.40
145.00	25.06	24.72	24.39	24.07	23.75
150.00	23.44	23.14	22.84	22.55	22.26
155.00	21.98	21.71	21.44	21.19	20.94
160.00	20.70	20.45	20.21	19.98	19.74

HYDROGRAPH ORDINATES (cfs)
 Output Time increment = 1.00 min
 Time on left represents time for first value in each row.

Time min					
165.00	19.51	19.28	19.05	18.83	18.61
170.00	18.40	18.18	17.97	17.77	17.56
175.00	17.37	17.19	17.00	16.82	16.64
180.00	16.47	16.29	16.12	15.95	15.79
185.00	15.62	15.46	15.30	15.15	14.99
190.00	14.84	14.69	14.55	14.40	14.26
195.00	14.12	13.98	13.85	13.73	13.60
200.00	13.48	13.37	13.25	13.13	13.02
205.00	12.91	12.79	12.68	12.58	12.47
210.00	12.36	12.26	12.16	12.06	11.96
215.00	11.86	11.76	11.67	11.57	11.48
220.00	11.39	11.30	11.21	11.12	11.03
225.00	10.94	10.86	10.77	10.69	10.60
230.00	10.53	10.46	10.38	10.31	10.24
235.00	10.17	10.10	10.02	9.96	9.89
240.00	9.82	9.75	9.68	9.61	9.55
245.00	9.48	9.41	9.34	9.27	9.20
250.00	9.13	9.06	8.99	8.93	8.86
255.00	8.79	8.72	8.65	8.59	8.52
260.00	8.46	8.39	8.33	8.27	8.21
265.00	8.15	8.08	8.02	7.96	7.91
270.00	7.85	7.79	7.73	7.67	7.62
275.00	7.57	7.52	7.47	7.42	7.37
280.00	7.32	7.27	7.23	7.18	7.13
285.00	7.09	7.04	6.99	6.95	6.90
290.00	6.86	6.81	6.77	6.72	6.68
295.00	6.64	6.59	6.55	6.51	6.46
300.00	6.42	6.38	6.34	6.30	6.26
305.00	6.21	6.17	6.13	6.09	6.05
310.00	6.01	5.97	5.93	5.89	5.86
315.00	5.82	5.78	5.74	5.70	5.66
320.00	5.63	5.59	5.55	5.51	5.48
325.00	5.44	5.41	5.37	5.33	5.30
330.00	5.26	5.23	5.19	5.16	5.12
335.00	5.09	5.06	5.02	4.99	4.96
340.00	4.92	4.90	4.87	4.84	4.81
345.00	4.78	4.76	4.73	4.70	4.67
350.00	4.65	4.62	4.59	4.57	4.54
355.00	4.51	4.49	4.46	4.43	4.41
360.00	4.38	4.35	4.33	4.30	4.27
365.00	4.25	4.22	4.20	4.17	4.15
370.00	4.12	4.09	4.07	4.04	4.02
375.00	3.99	3.97	3.95	3.92	3.90
380.00	3.87	3.85	3.82	3.80	3.78
385.00	3.75	3.73	3.70	3.68	3.66
390.00	3.63	3.61	3.59	3.57	3.54
395.00	3.52	3.50	3.48	3.45	3.43

Type.... Pond Routed HYG (total out)
 Name.... PENNIAL LAKE OUT Tag: C 100Y
 File.... C:\MY DOCUMENTS\PENNIAL PARK LAKE DETENTION.PPW
 Storm... C 100YR Tag: C 100Y

HYDROGRAPH ORDINATES (cfs)
 Output Time increment = 1.00 min
 Time on left represents time for first value in each row.

Time min					
400.00	3.41	3.36	3.29	3.22	3.15
405.00	3.09	3.02	2.96	2.90	2.84
410.00	2.78	2.72	2.67	2.62	2.58
415.00	2.54	2.49	2.45	2.41	2.37
420.00	2.33	2.30	2.26	2.22	2.19
425.00	2.15	2.11	2.08	2.05	2.01
430.00	1.98	1.95	1.91	1.88	1.85
435.00	1.82	1.79	1.76	1.73	1.71
440.00	1.68	1.65	1.62	1.60	1.57
445.00	1.54	1.52	1.49	1.47	1.45
450.00	1.42	1.40	1.38	1.35	1.33
455.00	1.31	1.29	1.27	1.25	1.23
460.00	1.21	1.19	1.17	1.15	1.13
465.00	1.11	1.09	1.07	1.06	1.04
470.00	1.02	1.01	.99	.97	.96
475.00	.94	.94	.93	.92	.91
480.00	.90	.89	.89	.88	.87
485.00	.86	.85	.85	.84	.83
490.00	.82	.82	.81	.80	.79
495.00	.79	.78	.77	.77	.76
500.00	.75	.75	.74	.73	.73
505.00	.72	.71	.71	.70	.69
510.00	.69	.68	.67	.67	.66
515.00	.66	.65	.64	.64	.63
520.00	.63	.62	.62	.61	.61
525.00	.60	.59	.59	.58	.58
530.00	.57	.57	.56	.56	.55
535.00	.55	.54	.54	.53	.53
540.00	.52	.52	.51	.51	.50
545.00	.50	.50	.49	.49	.48
550.00	.48	.47	.47	.46	.46
555.00	.46	.45	.45	.44	.44
560.00	.44	.43	.43	.42	.42
565.00	.42	.41	.41	.41	.40
570.00	.40	.39	.39	.39	.38
575.00	.38	.38	.37	.37	.37
580.00	.36	.36	.36	.35	.35
585.00	.35	.34	.34	.34	.34
590.00	.33	.33	.33	.32	.32
595.00	.32	.31	.31	.31	.31
600.00	.30	.30	.30	.30	.29
605.00	.29	.29	.28	.28	.28
610.00	.28	.27	.27	.27	.27
615.00	.26	.26	.26	.26	.26
620.00	.25	.25	.25	.25	.24
625.00	.24	.24	.24	.24	.23
630.00	.23	.23	.23	.22	.22

HYDROGRAPH ORDINATES (cfs)
 Output Time increment = 1.00 min
 Time on left represents time for first value in each row.

Time min					
635.00	.22	.22	.22	.21	.21
640.00	.21	.21	.21	.21	.20
645.00	.20	.20	.20	.20	.19
650.00	.19	.19	.19	.19	.19
655.00	.18	.18	.18	.18	.18
660.00	.18	.17	.17	.17	.17
665.00	.17	.17	.17	.16	.16
670.00	.16	.16	.16	.16	.15
675.00	.15	.15	.15	.15	.15
680.00	.15	.15	.14	.14	.14
685.00	.14	.14	.14	.14	.14
690.00	.13	.13	.13	.13	.13
695.00	.13	.13	.13	.12	.12
700.00	.12	.12	.12	.12	.12
705.00	.12	.12	.11	.11	.11
710.00	.11	.11	.11	.11	.11
715.00	.11	.11	.10	.10	.10
720.00	.10	.10	.10	.10	.10
725.00	.10	.10	.10	.09	.09
730.00	.09	.09	.09	.09	.09
735.00	.09	.09	.09	.09	.09
740.00	.09	.08	.08	.08	.08
745.00	.08	.08	.08	.08	.08
750.00	.08	.08	.08	.08	.07
755.00	.07	.07	.07	.07	.07
760.00	.07	.07	.07	.07	.07
765.00	.07	.07	.07	.07	.07
770.00	.06	.06	.06	.06	.06
775.00	.06	.06	.06	.06	.06
780.00	.06	.06	.06	.06	.06
785.00	.06	.06	.06	.06	.05
790.00	.05	.05	.05	.05	.05
795.00	.05	.05	.05	.05	.05
800.00	.05	.05	.05	.05	.05
805.00	.05	.05	.05	.05	.05
810.00	.05	.04	.04	.04	.04
815.00	.04	.04	.04	.04	.04
820.00	.04	.04	.04	.04	.04
825.00	.04	.04	.04	.04	.04
830.00	.04	.04	.04	.04	.04
835.00	.04	.04	.04	.03	.03
840.00	.03	.03	.03	.03	.03
845.00	.03	.03	.03	.03	.03
850.00	.03	.03	.03	.03	.03
855.00	.03	.03	.03	.03	.03
860.00	.03	.03	.03	.03	.03
865.00	.03	.03	.03	.03	.03

Type.... Pond Routed HYG (total out)
 Name.... PENNIAL LAKE OUT Tag: C 100Y
 File.... C:\MY DOCUMENTS\PENNIAL PARK LAKE DETENTION.PPW
 Storm... C 100YR Tag: C 100Y

HYDROGRAPH ORDINATES (cfs)
 Output Time increment = 1.00 min
 Time on left represents time for first value in each row.

Time min					
870.00	.03	.03	.03	.03	.03
875.00	.02	.02	.02	.02	.02
880.00	.02	.02	.02	.02	.02
885.00	.02	.02	.02	.02	.02
890.00	.02	.02	.02	.02	.02
895.00	.02	.02	.02	.02	.02
900.00	.02	.02	.02	.02	.02
905.00	.02	.02	.02	.02	.02
910.00	.02	.02	.02	.02	.02
915.00	.02	.02	.02	.02	.02
920.00	.02	.02	.02	.02	.02
925.00	.02	.02	.02	.02	.02
930.00	.02	.02	.01	.01	.01
935.00	.01	.01	.01	.01	.01
940.00	.01	.01	.01	.01	.01
945.00	.01	.01	.01	.01	.01
950.00	.01	.01	.01	.01	.01
955.00	.01	.01	.01	.01	.01
960.00	.01	.01	.01	.01	.01
965.00	.01	.01	.01	.01	.01
970.00	.01	.01	.01	.01	.01
975.00	.01	.01	.01	.01	.01
980.00	.01	.01	.01	.01	.01
985.00	.01	.01	.01	.01	.01
990.00	.01	.01	.01	.01	.01
995.00	.01	.01	.01	.01	.01
1000.00	.01	.01	.01	.01	.01
1005.00	.01	.01	.01	.01	.01
1010.00	.01	.01	.01	.01	.01
1015.00	.01	.01	.01	.01	.01
1020.00	.01	.01	.01	.01	.01
1025.00	.01	.01	.01	.01	.01
1030.00	.01	.01	.01	.01	.01
1035.00	.01	.01	.01	.01	.01
1040.00	.01	.01	.01	.01	.01
1045.00	.01	.01	.01	.01	.01
1050.00	.01	.01	.01	.00	.00
1055.00	.00	.00	.00	.00	.00
1060.00	.00	.00	.00	.00	.00
1065.00	.00	.00	.00	.00	.00
1070.00	.00	.00	.00	.00	.00
1075.00	.00	.00	.00	.00	.00
1080.00	.00	.00	.00	.00	.00
1085.00	.00	.00	.00	.00	.00
1090.00	.00	.00	.00	.00	.00
1095.00	.00	.00	.00	.00	.00
1100.00	.00	.00	.00	.00	.00

Type.... Pond Routed HYG (total out)

Name.... PENNIAL LAKE OUT Tag: C 100Y

File.... C:\MY DOCUMENTS\PENNIAL PARK LAKE DETENTION.PPW

Storm... C 100YR Tag: C 100Y

HYDROGRAPH ORDINATES (cfs)

Output Time increment = 1.00 min

Time on left represents time for first value in each row.

Time min					
1105.00	.00	.00	.00	.00	.00

Index of Starting Page Numbers for ID Names

----- C -----

CHERRY FLOWS A 15YR... 1.01, 1.04,
1.06

----- H -----

HUTCHINGS OUT... 1.08, 1.11, 1.14

----- L -----

LEGACY OUTFLOW A 15YR... 1.17, 1.20,
1.22

----- O -----

OFF AREA 2 A 15YR... 1.25, 1.28,
1.31OFFSITE AREA 3 A 15YR... 1.34, 1.37,
1.40OFFSITE AREA 4 A 15YR... 1.43, 1.44,
1.45ON-SITE INFLOW A 15YR... 1.46, 1.49,
1.52

----- P -----

PENNIAL LAKE... 2.01

PENNIAL LAKE IN A 15YR... 4.01,
4.05, 4.09, 4.13, 4.14, 4.19,
4.20, 4.25, 4.26

----- T -----

TRIPLE BOX W/BOX... 3.01, 3.06

POND7
Routing Calculations
15, 25 and 100 Year 20 Minute Design Storms
Avondale Heights

Table of Contents

***** RUNOFF HYDROGRAPHS *****

20 MINUTE INFLOW A 15yr
 Read HYG 1.01

20 MINUTE INFLOW B 25yr
 Read HYG 1.05

20 MINUTE INFLOW C 100y
 Read HYG 1.09

***** POND VOLUMES *****

BASIN B..... Vol: Planimeter 2.01

***** OUTLET STRUCTURES *****

OVERFLOW 44..... Outlet Input Data 3.01
 Composite Rating Curve 3.04

***** POND ROUTING *****

BASIN B OUT A 15yr
 Pond Routing Summary 4.01
 Pond Routed HYG (total out) 4.02

BASIN B OUT B 25yr
 Pond Routing Summary 4.12
 Pond Routed HYG (total out) 4.13

BASIN B OUT C 100y
 Pond Routing Summary 4.23
 Pond Routed HYG (total out) 4.24

Type.... Read HYG Page 1.01
 Name.... 20 MINUTE INFLOW Tag: A 15yr Event: A 15yr
 File.... C:\MY DOCUMENTS\AVONDALE HEIGHTS DETENTION.PPW
 Title... 15, 25 and 100 Year Inflows to Basin B of Avondale
 Heights
 Storm... Tag: A 15yr

HYG file = C:\MY DOCUMENTS\AVON 15.HYG
 HYG ID = Avondale 15yr in
 HYG Tag = 15yr

 Peak Discharge = 39.92 cfs
 Time to Peak = 5.00 min
 HYG Volume = 47904 cu.ft

HYDROGRAPH ORDINATES (cfs)
 Output Time increment = 1.00 min
 Time on left represents time for first value in each row.

Time min					
.00	.00	7.98	15.97	23.95	31.94
5.00	39.92	39.92	39.92	39.92	39.92
10.00	39.92	39.92	39.92	39.92	39.92
15.00	39.92	39.92	39.92	39.92	39.92
20.00	39.92	31.94	23.95	15.97	7.98
25.00	.00	.00	.00	.00	.00
30.00	.00	.00	.00	.00	.00
35.00	.00	.00	.00	.00	.00
40.00	.00	.00	.00	.00	.00
45.00	.00	.00	.00	.00	.00
50.00	.00	.00	.00	.00	.00
55.00	.00	.00	.00	.00	.00
60.00	.00	.00	.00	.00	.00
65.00	.00	.00	.00	.00	.00
70.00	.00	.00	.00	.00	.00
75.00	.00	.00	.00	.00	.00
80.00	.00	.00	.00	.00	.00
85.00	.00	.00	.00	.00	.00
90.00	.00	.00	.00	.00	.00
95.00	.00	.00	.00	.00	.00
100.00	.00	.00	.00	.00	.00
105.00	.00	.00	.00	.00	.00
110.00	.00	.00	.00	.00	.00
115.00	.00	.00	.00	.00	.00
120.00	.00	.00	.00	.00	.00
125.00	.00	.00	.00	.00	.00
130.00	.00	.00	.00	.00	.00
135.00	.00	.00	.00	.00	.00
140.00	.00	.00	.00	.00	.00
145.00	.00	.00	.00	.00	.00
150.00	.00	.00	.00	.00	.00

Type... Read HYG

Name... 20 MINUTE INFLOW Tag: A 15yr

File... C:\MY DOCUMENTS\AVONDALE HEIGHTS DETENTION.PPW

Title... 15, 25 and 100 Year Inflows to Basin B of Avondale Heights

Storm... Tag: A 15yr

HYDROGRAPH ORDINATES (cfs)

Time min	Output Time increment = 1.00 min				
	Time on left represents time for first value in each row.				
155.00	.00	.00	.00	.00	.00
160.00	.00	.00	.00	.00	.00
165.00	.00	.00	.00	.00	.00
170.00	.00	.00	.00	.00	.00
175.00	.00	.00	.00	.00	.00
180.00	.00	.00	.00	.00	.00
185.00	.00	.00	.00	.00	.00
190.00	.00	.00	.00	.00	.00
195.00	.00	.00	.00	.00	.00
200.00	.00	.00	.00	.00	.00
205.00	.00	.00	.00	.00	.00
210.00	.00	.00	.00	.00	.00
215.00	.00	.00	.00	.00	.00
220.00	.00	.00	.00	.00	.00
225.00	.00	.00	.00	.00	.00
230.00	.00	.00	.00	.00	.00
235.00	.00	.00	.00	.00	.00
240.00	.00	.00	.00	.00	.00
245.00	.00	.00	.00	.00	.00
250.00	.00	.00	.00	.00	.00
255.00	.00	.00	.00	.00	.00
260.00	.00	.00	.00	.00	.00
265.00	.00	.00	.00	.00	.00
270.00	.00	.00	.00	.00	.00
275.00	.00	.00	.00	.00	.00
280.00	.00	.00	.00	.00	.00
285.00	.00	.00	.00	.00	.00
290.00	.00	.00	.00	.00	.00
295.00	.00	.00	.00	.00	.00
300.00	.00	.00	.00	.00	.00
305.00	.00	.00	.00	.00	.00
310.00	.00	.00	.00	.00	.00
315.00	.00	.00	.00	.00	.00
320.00	.00	.00	.00	.00	.00
325.00	.00	.00	.00	.00	.00
330.00	.00	.00	.00	.00	.00
335.00	.00	.00	.00	.00	.00
340.00	.00	.00	.00	.00	.00
345.00	.00	.00	.00	.00	.00
350.00	.00	.00	.00	.00	.00
355.00	.00	.00	.00	.00	.00
360.00	.00	.00	.00	.00	.00
365.00	.00	.00	.00	.00	.00
370.00	.00	.00	.00	.00	.00
375.00	.00	.00	.00	.00	.00

Type.... Read HYG

Name.... 20 MINUTE INFLOW Tag: A 15yr

File.... C:\MY DOCUMENTS\AVONDALE HEIGHTS DETENTION.PPW

Title... 15, 25 and 100 Year Inflows to Basin B of Avondale Heights

Storm... Tag: A 15yr

HYDROGRAPH ORDINATES (cfs)

Output Time increment = 1.00 min

Time on left represents time for first value in each row.

Time min					
380.00	.00	.00	.00	.00	.00
385.00	.00	.00	.00	.00	.00
390.00	.00	.00	.00	.00	.00
395.00	.00	.00	.00	.00	.00
400.00	.00	.00	.00	.00	.00
405.00	.00	.00	.00	.00	.00
410.00	.00	.00	.00	.00	.00
415.00	.00	.00	.00	.00	.00
420.00	.00	.00	.00	.00	.00
425.00	.00	.00	.00	.00	.00
430.00	.00	.00	.00	.00	.00
435.00	.00	.00	.00	.00	.00
440.00	.00	.00	.00	.00	.00
445.00	.00	.00	.00	.00	.00
450.00	.00	.00	.00	.00	.00
455.00	.00	.00	.00	.00	.00
460.00	.00	.00	.00	.00	.00
465.00	.00	.00	.00	.00	.00
470.00	.00	.00	.00	.00	.00
475.00	.00	.00	.00	.00	.00
480.00	.00	.00	.00	.00	.00
485.00	.00	.00	.00	.00	.00
490.00	.00	.00	.00	.00	.00
495.00	.00	.00	.00	.00	.00
500.00	.00	.00	.00	.00	.00
505.00	.00	.00	.00	.00	.00
510.00	.00	.00	.00	.00	.00
515.00	.00	.00	.00	.00	.00
520.00	.00	.00	.00	.00	.00
525.00	.00	.00	.00	.00	.00
530.00	.00	.00	.00	.00	.00
535.00	.00	.00	.00	.00	.00
540.00	.00	.00	.00	.00	.00
545.00	.00	.00	.00	.00	.00
550.00	.00	.00	.00	.00	.00
555.00	.00	.00	.00	.00	.00
560.00	.00	.00	.00	.00	.00
565.00	.00	.00	.00	.00	.00
570.00	.00	.00	.00	.00	.00
575.00	.00	.00	.00	.00	.00
580.00	.00	.00	.00	.00	.00
585.00	.00	.00	.00	.00	.00
590.00	.00	.00	.00	.00	.00
595.00	.00	.00	.00	.00	.00
600.00	.00	.00	.00	.00	.00

Type.... Read HYG

Name.... 20 MINUTE INFLOW Tag: A 15yr

File.... C:\MY DOCUMENTS\AVONDALE HEIGHTS DETENTION.PPW

Title... 15, 25 and 100 Year Inflows to Basin B of Avondale Heights

Storm... Tag: A 15yr

HYDROGRAPH ORDINATES (cfs)

Output Time increment = 1.00 min
Time on left represents time for first value in each row.

Time min					
605.00	.00	.00	.00	.00	.00
610.00	.00	.00	.00	.00	.00
615.00	.00	.00	.00	.00	.00
620.00	.00	.00	.00	.00	.00
625.00	.00	.00	.00	.00	.00
630.00	.00	.00	.00	.00	.00
635.00	.00	.00	.00	.00	.00
640.00	.00	.00	.00	.00	.00
645.00	.00	.00	.00	.00	.00
650.00	.00	.00	.00	.00	.00
655.00	.00	.00	.00	.00	.00
660.00	.00	.00	.00	.00	.00
665.00	.00	.00	.00	.00	.00
670.00	.00	.00	.00	.00	.00
675.00	.00	.00	.00	.00	.00
680.00	.00	.00	.00	.00	.00
685.00	.00	.00	.00	.00	.00
690.00	.00	.00	.00	.00	.00
695.00	.00	.00	.00	.00	.00
700.00	.00				

Type.... Read HYG
 Name.... 20 MINUTE INFLOW
 File.... C:\MY DOCUMENTS\AVONDALE HEIGHTS DETENTION.PPW
 Storm... Tag: B 25yr

Page 1.05
 Event: B 25yr

HYG file = C:\MY DOCUMENTS\AVON 25.HYG
 HYG ID = Aondale 25yr in
 HYG Tag = 25yr

 Peak Discharge = 49.29 cfs
 Time to Peak = 5.00 min
 HYG Volume = 59250 cu.ft

HYDROGRAPH ORDINATES (cfs)
 Output Time increment = 1.00 min
 Time on left represents time for first value in each row.

Time min					
.00	.00	9.86	19.72	29.95	39.94
5.00	49.29	49.29	49.29	49.29	49.29
10.00	49.29	49.29	49.20	49.29	49.29
15.00	49.29	49.29	49.29	49.29	49.29
20.00	49.29	39.94	29.95	19.72	9.86
25.00	.00	.00	.00	.00	.00
30.00	.00	.00	.00	.00	.00
35.00	.00	.00	.00	.00	.00
40.00	.00	.00	.00	.00	.00
45.00	.00	.00	.00	.00	.00
50.00	.00	.00	.00	.00	.00
55.00	.00	.00	.00	.00	.00
60.00	.00	.00	.00	.00	.00
65.00	.00	.00	.00	.00	.00
70.00	.00	.00	.00	.00	.00
75.00	.00	.00	.00	.00	.00
80.00	.00	.00	.00	.00	.00
85.00	.00	.00	.00	.00	.00
90.00	.00	.00	.00	.00	.00
95.00	.00	.00	.00	.00	.00
100.00	.00	.00	.00	.00	.00
105.00	.00	.00	.00	.00	.00
110.00	.00	.00	.00	.00	.00
115.00	.00	.00	.00	.00	.00
120.00	.00	.00	.00	.00	.00
125.00	.00	.00	.00	.00	.00
130.00	.00	.00	.00	.00	.00
135.00	.00	.00	.00	.00	.00
140.00	.00	.00	.00	.00	.00
145.00	.00	.00	.00	.00	.00
150.00	.00	.00	.00	.00	.00
155.00	.00	.00	.00	.00	.00
160.00	.00	.00	.00	.00	.00

Type.... Read HYG
 Name.... 20 MINUTE INFLOW
 File.... C:\MY DOCUMENTS\AVONDALE HEIGHTS DETENTION.PPW
 Storm... Tag: B 25yr

HYDROGRAPH ORDINATES (cfs)
 Output Time increment = 1.00 min
 Time on left represents time for first value in each row.

Time min					
165.00	.00	.00	.00	.00	.00
170.00	.00	.00	.00	.00	.00
175.00	.00	.00	.00	.00	.00
180.00	.00	.00	.00	.00	.00
185.00	.00	.00	.00	.00	.00
190.00	.00	.00	.00	.00	.00
195.00	.00	.00	.00	.00	.00
200.00	.00	.00	.00	.00	.00
205.00	.00	.00	.00	.00	.00
210.00	.00	.00	.00	.00	.00
215.00	.00	.00	.00	.00	.00
220.00	.00	.00	.00	.00	.00
225.00	.00	.00	.00	.00	.00
230.00	.00	.00	.00	.00	.00
235.00	.00	.00	.00	.00	.00
240.00	.00	.00	.00	.00	.00
245.00	.00	.00	.00	.00	.00
250.00	.00	.00	.00	.00	.00
255.00	.00	.00	.00	.00	.00
260.00	.00	.00	.00	.00	.00
265.00	.00	.00	.00	.00	.00
270.00	.00	.00	.00	.00	.00
275.00	.00	.00	.00	.00	.00
280.00	.00	.00	.00	.00	.00
285.00	.00	.00	.00	.00	.00
290.00	.00	.00	.00	.00	.00
295.00	.00	.00	.00	.00	.00
300.00	.00	.00	.00	.00	.00
305.00	.00	.00	.00	.00	.00
310.00	.00	.00	.00	.00	.00
315.00	.00	.00	.00	.00	.00
320.00	.00	.00	.00	.00	.00
325.00	.00	.00	.00	.00	.00
330.00	.00	.00	.00	.00	.00
335.00	.00	.00	.00	.00	.00
340.00	.00	.00	.00	.00	.00
345.00	.00	.00	.00	.00	.00
350.00	.00	.00	.00	.00	.00
355.00	.00	.00	.00	.00	.00
360.00	.00	.00	.00	.00	.00
365.00	.00	.00	.00	.00	.00
370.00	.00	.00	.00	.00	.00
375.00	.00	.00	.00	.00	.00
380.00	.00	.00	.00	.00	.00
385.00	.00	.00	.00	.00	.00
390.00	.00	.00	.00	.00	.00
395.00	.00	.00	.00	.00	.00

Type.... Read HYG
 Name.... 20 MINUTE INFLOW
 File.... C:\MY DOCUMENTS\AVONDALE HEIGHTS DETENTION.PPW
 Storm... Tag: B 25yr

HYDROGRAPH ORDINATES (cfs)
 Output Time increment = 1.00 min
 Time on left represents time for first value in each row.

Time min					
400.00	.00	.00	.00	.00	.00
405.00	.00	.00	.00	.00	.00
410.00	.00	.00	.00	.00	.00
415.00	.00	.00	.00	.00	.00
420.00	.00	.00	.00	.00	.00
425.00	.00	.00	.00	.00	.00
430.00	.00	.00	.00	.00	.00
435.00	.00	.00	.00	.00	.00
440.00	.00	.00	.00	.00	.00
445.00	.00	.00	.00	.00	.00
450.00	.00	.00	.00	.00	.00
455.00	.00	.00	.00	.00	.00
460.00	.00	.00	.00	.00	.00
465.00	.00	.00	.00	.00	.00
470.00	.00	.00	.00	.00	.00
475.00	.00	.00	.00	.00	.00
480.00	.00	.00	.00	.00	.00
485.00	.00	.00	.00	.00	.00
490.00	.00	.00	.00	.00	.00
495.00	.00	.00	.00	.00	.00
500.00	.00	.00	.00	.00	.00
505.00	.00	.00	.00	.00	.00
510.00	.00	.00	.00	.00	.00
515.00	.00	.00	.00	.00	.00
520.00	.00	.00	.00	.00	.00
525.00	.00	.00	.00	.00	.00
530.00	.00	.00	.00	.00	.00
535.00	.00	.00	.00	.00	.00
540.00	.00	.00	.00	.00	.00
545.00	.00	.00	.00	.00	.00
550.00	.00	.00	.00	.00	.00
555.00	.00	.00	.00	.00	.00
560.00	.00	.00	.00	.00	.00
565.00	.00	.00	.00	.00	.00
570.00	.00	.00	.00	.00	.00
575.00	.00	.00	.00	.00	.00
580.00	.00	.00	.00	.00	.00
585.00	.00	.00	.00	.00	.00
590.00	.00	.00	.00	.00	.00
595.00	.00	.00	.00	.00	.00
600.00	.00	.00	.00	.00	.00
605.00	.00	.00	.00	.00	.00
610.00	.00	.00	.00	.00	.00
615.00	.00	.00	.00	.00	.00
620.00	.00	.00	.00	.00	.00
625.00	.00	.00	.00	.00	.00
630.00	.00	.00	.00	.00	.00

Type.... Read HYG
 Name.... 20 MINUTE INFLOW
 File.... C:\MY DOCUMENTS\AVONDALE HEIGHTS DETENTION.PPW
 Storm... Tag: B 25yr

Page 1.08
 Event: B 25yr

HYDROGRAPH ORDINATES (cfs)
 Output Time increment = 1.00 min
 Time on left represents time for first value in each row.

Time min					
635.00	.00	.00	.00	.00	.00
640.00	.00	.00	.00	.00	.00
645.00	.00	.00	.00	.00	.00
650.00	.00	.00	.00	.00	.00
655.00	.00	.00	.00	.00	.00
660.00	.00	.00	.00	.00	.00
665.00	.00	.00	.00	.00	.00
670.00	.00	.00	.00	.00	.00
675.00	.00	.00	.00	.00	.00
680.00	.00	.00	.00	.00	.00
685.00	.00	.00	.00	.00	.00
690.00	.00	.00	.00	.00	.00
695.00	.00	.00	.00	.00	.00
700.00	.00				

Type.... Read HYG
 Name.... 20 MINUTE INFLOW
 File.... C:\MY DOCUMENTS\AVONDALE HEIGHTS DETENTION.PPW
 Storm... Tag: C 100y

HYG file = C:\MY DOCUMENTS\AVON 100.HYG
 HYG ID = Avondale100yr in
 HYG Tag = 100yr

 Peak Discharge = 63.05 cfs
 Time to Peak = 5.00 min
 HYG Volume = 75660 cu.ft

HYDROGRAPH ORDINATES (cfs)
 Output Time increment = 1.00 min
 Time on left represents time for first value in each row.

Time min					
.00	.00	12.61	25.22	37.83	50.44
5.00	63.05	63.05	63.05	63.05	63.05
10.00	63.05	63.05	63.05	63.05	63.05
15.00	63.05	63.05	63.05	63.05	63.05
20.00	63.05	50.44	37.83	25.22	12.61
25.00	.00	.00	.00	.00	.00
30.00	.00	.00	.00	.00	.00
35.00	.00	.00	.00	.00	.00
40.00	.00	.00	.00	.00	.00
45.00	.00	.00	.00	.00	.00
50.00	.00	.00	.00	.00	.00
55.00	.00	.00	.00	.00	.00
60.00	.00	.00	.00	.00	.00
65.00	.00	.00	.00	.00	.00
70.00	.00	.00	.00	.00	.00
75.00	.00	.00	.00	.00	.00
80.00	.00	.00	.00	.00	.00
85.00	.00	.00	.00	.00	.00
90.00	.00	.00	.00	.00	.00
95.00	.00	.00	.00	.00	.00
100.00	.00	.00	.00	.00	.00
105.00	.00	.00	.00	.00	.00
110.00	.00	.00	.00	.00	.00
115.00	.00	.00	.00	.00	.00
120.00	.00	.00	.00	.00	.00
125.00	.00	.00	.00	.00	.00
130.00	.00	.00	.00	.00	.00
135.00	.00	.00	.00	.00	.00
140.00	.00	.00	.00	.00	.00
145.00	.00	.00	.00	.00	.00
150.00	.00	.00	.00	.00	.00
155.00	.00	.00	.00	.00	.00
160.00	.00	.00	.00	.00	.00

Type.... Read HYG
 Name.... 20 MINUTE INFLOW
 File.... C:\MY DOCUMENTS\AVONDALE HEIGHTS DETENTION.PPW
 Storm... Tag: C 100y

HYDROGRAPH ORDINATES (cfs)
 Output Time increment = 1.00 min
 Time on left represents time for first value in each row.

Time min					
165.00	.00	.00	.00	.00	.00
170.00	.00	.00	.00	.00	.00
175.00	.00	.00	.00	.00	.00
180.00	.00	.00	.00	.00	.00
185.00	.00	.00	.00	.00	.00
190.00	.00	.00	.00	.00	.00
195.00	.00	.00	.00	.00	.00
200.00	.00	.00	.00	.00	.00
205.00	.00	.00	.00	.00	.00
210.00	.00	.00	.00	.00	.00
215.00	.00	.00	.00	.00	.00
220.00	.00	.00	.00	.00	.00
225.00	.00	.00	.00	.00	.00
230.00	.00	.00	.00	.00	.00
235.00	.00	.00	.00	.00	.00
240.00	.00	.00	.00	.00	.00
245.00	.00	.00	.00	.00	.00
250.00	.00	.00	.00	.00	.00
255.00	.00	.00	.00	.00	.00
260.00	.00	.00	.00	.00	.00
265.00	.00	.00	.00	.00	.00
270.00	.00	.00	.00	.00	.00
275.00	.00	.00	.00	.00	.00
280.00	.00	.00	.00	.00	.00
285.00	.00	.00	.00	.00	.00
290.00	.00	.00	.00	.00	.00
295.00	.00	.00	.00	.00	.00
300.00	.00	.00	.00	.00	.00
305.00	.00	.00	.00	.00	.00
310.00	.00	.00	.00	.00	.00
315.00	.00	.00	.00	.00	.00
320.00	.00	.00	.00	.00	.00
325.00	.00	.00	.00	.00	.00
330.00	.00	.00	.00	.00	.00
335.00	.00	.00	.00	.00	.00
340.00	.00	.00	.00	.00	.00
345.00	.00	.00	.00	.00	.00
350.00	.00	.00	.00	.00	.00
355.00	.00	.00	.00	.00	.00
360.00	.00	.00	.00	.00	.00
365.00	.00	.00	.00	.00	.00
370.00	.00	.00	.00	.00	.00
375.00	.00	.00	.00	.00	.00
380.00	.00	.00	.00	.00	.00
385.00	.00	.00	.00	.00	.00
390.00	.00	.00	.00	.00	.00
395.00	.00	.00	.00	.00	.00

Type... Read HYG
 Name... 20 MINUTE INFLOW
 File... C:\MY DOCUMENTS\AVONDALE HEIGHTS DETENTION.PPW
 Storm... Tag: C 100y

HYDROGRAPH ORDINATES (cfs)
 Output Time increment = 1.00 min
 Time on left represents time for first value in each row.

Time min					
400.00	.00	.00	.00	.00	.00
405.00	.00	.00	.00	.00	.00
410.00	.00	.00	.00	.00	.00
415.00	.00	.00	.00	.00	.00
420.00	.00	.00	.00	.00	.00
425.00	.00	.00	.00	.00	.00
430.00	.00	.00	.00	.00	.00
435.00	.00	.00	.00	.00	.00
440.00	.00	.00	.00	.00	.00
445.00	.00	.00	.00	.00	.00
450.00	.00	.00	.00	.00	.00
455.00	.00	.00	.00	.00	.00
460.00	.00	.00	.00	.00	.00
465.00	.00	.00	.00	.00	.00
470.00	.00	.00	.00	.00	.00
475.00	.00	.00	.00	.00	.00
480.00	.00	.00	.00	.00	.00
485.00	.00	.00	.00	.00	.00
490.00	.00	.00	.00	.00	.00
495.00	.00	.00	.00	.00	.00
500.00	.00	.00	.00	.00	.00
505.00	.00	.00	.00	.00	.00
510.00	.00	.00	.00	.00	.00
515.00	.00	.00	.00	.00	.00
520.00	.00	.00	.00	.00	.00
525.00	.00	.00	.00	.00	.00
530.00	.00	.00	.00	.00	.00
535.00	.00	.00	.00	.00	.00
540.00	.00	.00	.00	.00	.00
545.00	.00	.00	.00	.00	.00
550.00	.00	.00	.00	.00	.00
555.00	.00	.00	.00	.00	.00
560.00	.00	.00	.00	.00	.00
565.00	.00	.00	.00	.00	.00
570.00	.00	.00	.00	.00	.00
575.00	.00	.00	.00	.00	.00
580.00	.00	.00	.00	.00	.00
585.00	.00	.00	.00	.00	.00
590.00	.00	.00	.00	.00	.00
595.00	.00	.00	.00	.00	.00
600.00	.00	.00	.00	.00	.00
605.00	.00	.00	.00	.00	.00
610.00	.00	.00	.00	.00	.00
615.00	.00	.00	.00	.00	.00
620.00	.00	.00	.00	.00	.00
625.00	.00	.00	.00	.00	.00
630.00	.00	.00	.00	.00	.00

Type.... Read HYG
 Name.... 20 MINUTE INFLOW
 File.... C:\MY DOCUMENTS\AVONDALE HEIGHTS DETENTION.PPW
 Storm... Tag: C 100y

HYDROGRAPH ORDINATES (cfs)
 Output Time increment = 1.00 min
 Time on left represents time for first value in each row.

Time min					
635.00	.00	.00	.00	.00	.00
640.00	.00	.00	.00	.00	.00
645.00	.00	.00	.00	.00	.00
650.00	.00	.00	.00	.00	.00
655.00	.00	.00	.00	.00	.00
660.00	.00	.00	.00	.00	.00
665.00	.00	.00	.00	.00	.00
670.00	.00	.00	.00	.00	.00
675.00	.00	.00	.00	.00	.00
680.00	.00	.00	.00	.00	.00
685.00	.00	.00	.00	.00	.00
690.00	.00	.00	.00	.00	.00
695.00	.00	.00	.00	.00	.00
700.00	.00				

Type.... Vol: Planimeter
Name.... BASIN B

File.... C:\MY DOCUMENTS\AVONDALE HEIGHTS DETENTION.PPW
Title... Avondale Heights; Basin B

POND VOLUME CALCULATIONS

Planimeter scale: 1.00 ft/in

Elevation (ft)	Planimeter (sq. in)	Area (acres)	A1+A2+sqrt(A1*A2) (acres)	Volume (cu. ft)	Volume Sum (cu. ft)
498.00	37603.600	.8633	.0000	0	0
500.00	42556.600	.9770	2.7586	80109	80109
502.00	47610.640	1.0930	3.1033	90120	170229

POND VOLUME EQUATIONS

* Incremental volume computed by the Conic Method for Reservoir Volumes.

$$\text{Volume} = (1/3) * (\text{EL2} - \text{EL1}) * (\text{Area1} + \text{Area2} + \text{sq. rt.}(\text{Area1} * \text{Area2}))$$

where: EL1, EL2 = Lower and upper elevations of the increment
Area1, Area2 = Areas computed for EL1, EL2, respectively
Volume = Incremental volume between EL1 and EL2

Type.... Outlet Input Data
Name.... OVERFLOW 44

File.... C:\MY DOCUMENTS\AVONDALE HEIGHTS DETENTION.PPW
Title... Overflow Structure 44 in Basin B of Avondale Heights

REQUESTED POND WS ELEVATIONS:

Min. Elev.= 498.00 ft
Increment = .10 ft
Max. Elev.= 502.00 ft

OUTLET CONNECTIVITY

---> Forward Flow Only (UpStream to DnStream)
<--- Reverse Flow Only (DnStream to UpStream)
<---> Forward and Reverse Both Allowed

Structure	No.		Outfall	E1, ft	E2, ft
Stand Pipe	AI	--->	CV	499.200	502.000
Weir-Rectangular	SL	--->	CV	498.000	502.000
Culvert-Circular	CV	--->	TW	497.000	502.000
TW SETUP, DS Channel					

Type.... Outlet Input Data
Name.... OVERFLOW 44

Page 3.02

File.... C:\MY DOCUMENTS\AVONDALE HEIGHTS DETENTION.PPW
Title... Overflow Structure 44 in Basin B of Avondale Heights

OUTLET STRUCTURE INPUT DATA

Structure ID = AI
Structure Type = Stand Pipe

of Openings = 1
Invert Elev. = 499.20 ft
Diameter = 3.5000 ft
Orifice Area = 9.6211 sq.ft
Orifice Coeff. = .600
Weir Length = 11.00 ft
Weir Coeff. = 3.000
K, Submerged = .000
K, Reverse = 1.000
Kb, Barrel = .000000 (per ft of full flow)
Barrel Length = .00 ft
Mannings n = .0000

Structure ID = SL
Structure Type = Weir-Rectangular

of Openings = 1
Crest Elev. = 498.00 ft
Weir Length = .67 ft
Weir Coeff. = 3.000000

Weir TW effects (Use adjustment equation)

Type.... Outlet Input Data
Name.... OVERFLOW 44

File.... C:\MY DOCUMENTS\AVONDALE HEIGHTS DETENTION.PPW
Title... Overflow Structure 44 in Basin B of Avondale Heights

OUTLET STRUCTURE INPUT DATA

Structure ID = CV
Structure Type = Culvert-Circular

No. Barrels = 1
Barrel Diameter = 2.0000 ft
Upstream Invert = 497.00 ft
Dnstream Invert = 496.00 ft
Horiz. Length = 46.24 ft
Barrel Length = 46.25 ft
Barrel Slope = .02163 ft/ft

OUTLET CONTROL DATA...

Mannings n = .0130
Ke = .5000 (forward entrance loss)
Kb = .012411 (per ft of full flow)
Kr = .5000 (reverse entrance loss)
HW Convergence = .001 +/- ft

INLET CONTROL DATA...

Equation form = 1
Inlet Control K = .0078
Inlet Control M = 2.0000
Inlet Control c = .02920
Inlet Control Y = .7400
T1 ratio (HW/D) = 1.125
T2 ratio (HW/D) = 1.196
Slope Factor = -.500

Use unsubmerged inlet control Form 1 equ. below T1 elev.
Use submerged inlet control Form 1 equ. above T2 elev.

In transition zone between unsubmerged and submerged inlet control,
interpolate between flows at T1 & T2...

At T1 Elev = 499.25 ft ---> Flow = 15.55 cfs
At T2 Elev = 499.39 ft ---> Flow = 17.77 cfs

Structure ID = TW
Structure Type = TW SETUP, DS Channel

FREE OUTFALL CONDITIONS SPECIFIED

CONVERGENCE TOLERANCES...

Maximum Iterations = 30
Min. TW tolerance = .01 ft
Max. TW tolerance = .01 ft
Min. HW tolerance = .01 ft
Max. HW tolerance = .01 ft
Min. Q tolerance = .10 cfs
Max. Q tolerance = .10 cfs

File.... C:\MY DOCUMENTS\AVONDALE HEIGHTS DETENTION.PPW
 Title... Overflow Structure 44 in Basin B of Avondale Heights

***** COMPOSITE OUTFLOW SUMMARY *****

WS Elev, Total Q		Converge		Notes
Elev. ft	Q cfs	TW Elev ft	Error +/-ft	Contributing Structures
498.00	.00	Free	Outfall	(no Q: AI,SL,CV)
498.10	.06	Free	Outfall	SL,CV (no Q: AI)
498.20	.18	Free	Outfall	SL,CV (no Q: AI)
498.30	.33	Free	Outfall	SL,CV (no Q: AI)
498.40	.51	Free	Outfall	SL,CV (no Q: AI)
498.50	.71	Free	Outfall	SL,CV (no Q: AI)
498.60	.93	Free	Outfall	SL,CV (no Q: AI)
498.70	1.18	Free	Outfall	SL,CV (no Q: AI)
498.80	1.44	Free	Outfall	SL,CV (no Q: AI)
498.90	1.72	Free	Outfall	SL,CV (no Q: AI)
499.00	2.01	Free	Outfall	SL,CV (no Q: AI)
499.10	2.32	Free	Outfall	SL,CV (no Q: AI)
499.20	2.64	Free	Outfall	SL,CV (no Q: AI)
499.30	4.00	Free	Outfall	AI,SL,CV
499.40	6.10	Free	Outfall	AI,SL,CV
499.50	8.65	Free	Outfall	AI,SL,CV
499.60	11.49	Free	Outfall	AI,SL,CV
499.70	14.57	Free	Outfall	AI,CV (no Q: SL)
499.80	17.59	Free	Outfall	AI,CV (no Q: SL)
499.90	20.18	Free	Outfall	AI,CV (no Q: SL)
500.00	21.07	Free	Outfall	AI,CV (no Q: SL)
500.10	21.97	Free	Outfall	AI,CV (no Q: SL)
500.20	22.84	Free	Outfall	AI,CV (no Q: SL)
500.30	23.68	Free	Outfall	AI,CV (no Q: SL)
500.40	24.52	Free	Outfall	AI,CV (no Q: SL)
500.50	25.34	Free	Outfall	AI,CV (no Q: SL)
500.60	26.13	Free	Outfall	AI,CV (no Q: SL)
500.70	26.91	Free	Outfall	AI,CV (no Q: SL)
500.80	27.67	Free	Outfall	AI,CV (no Q: SL)
500.90	28.41	Free	Outfall	AI,CV (no Q: SL)
501.00	29.14	Free	Outfall	AI,CV (no Q: SL)
501.10	29.84	Free	Outfall	AI,CV (no Q: SL)
501.20	30.45	Free	Outfall	AI,CV (no Q: SL)
501.30	30.99	Free	Outfall	AI,CV (no Q: SL)
501.40	31.53	Free	Outfall	AI,CV (no Q: SL)
501.50	32.07	Free	Outfall	AI,CV (no Q: SL)
501.60	32.59	Free	Outfall	AI,CV (no Q: SL)
501.70	33.10	Free	Outfall	AI,CV (no Q: SL)
501.80	33.61	Free	Outfall	AI,CV (no Q: SL)

Type.... Composite Rating Curve
Name.... OVERFLOW 44

File.... C:\MY DOCUMENTS\AVONDALE HEIGHTS DETENTION.PPW
Title... Overflow Structure 44 in Basin B of Avondale Heights

***** COMPOSITE OUTFLOW SUMMARY *****

WS Elev, Total Q		Converge		Notes
Elev. ft	Q cfs	TW Elev ft	Error +/-ft	Contributing Structures
501.90	34.11	Free Outfall		AI,CV (no Q: SL)
502.00	34.59	Free Outfall		AI,CV (no Q: SL)

Type.... Pond Routing Summary
Name.... BASIN B OUT Tag: A 15yr
File.... C:\MY DOCUMENTS\AVONDALE HEIGHTS DETENTION.PPW
Storm... A 15yr Tag: A 15yr

Page 4.01
Event: A 15yr

LEVEL POOL ROUTING SUMMARY

HYG Dir = C:\MY DOCUMENTS\
Inflow HYG file = NONE STORED - BASIN B IN A 15yr
Outflow HYG file = NONE STORED - BASIN B OUT A 15yr

Pond Node Data = BASIN B
Pond Volume Data = BASIN B
Pond Outlet Data = OVERFLOW 44

No Infiltration

INITIAL CONDITIONS

Starting WS Elev = 498.00 ft
Starting Volume = 0 cu.ft
Starting Outflow = .00 cfs
Starting Infiltr. = .00 cfs
Starting Total Qout = .00 cfs
Time Increment = 1.00 min

INFLOW/OUTFLOW HYDROGRAPH SUMMARY

=====
Peak Inflow = 39.92 cfs at 5.00 min
Peak Outflow = 2.59 cfs at 25.00 min

Peak Elevation = 499.18 ft
Peak Storage = 46222 cu.ft
=====

MASS BALANCE (cu.ft)

+ Initial Vol = 0
+ HYG Vol IN = 47904
- Infiltration = 0
- HYG Vol OUT = 45775
- Retained Vol = 2126

Unrouted Vol = -3 cu.ft (.007% of Inflow Volume)

WARNING: Outflow hydrograph truncated on right side.

Type.... Pond Routed HYG (total out)
 Name.... BASIN B OUT Tag: A 15yr
 File.... C:\MY DOCUMENTS\AVONDALE HEIGHTS DETENTION.PPW
 Storm... A 15yr Tag: A 15yr

POND ROUTED TOTAL OUTFLOW HYG...

HYG file =
 HYG ID = BASIN B OUT
 HYG Tag = A 15yr

 Peak Discharge = 2.59 cfs
 Time to Peak = 25.00 min
 HYG Volume = 45775 cu.ft

WARNING: Hydrograph truncated on right side.

HYDROGRAPH ORDINATES (cfs)						
Output Time increment = 1.00 min						
Time min	Time on left represents time for first value in each row.					

.00	.00	.00	.02	.04	.07	
5.00	.13	.21	.30	.41	.52	
10.00	.64	.77	.91	1.05	1.20	
15.00	1.35	1.51	1.67	1.83	2.00	
20.00	2.18	2.33	2.45	2.54	2.58	
25.00	2.59	2.58	2.57	2.55	2.54	
30.00	2.53	2.52	2.50	2.49	2.48	
35.00	2.47	2.46	2.45	2.43	2.42	
40.00	2.41	2.40	2.39	2.38	2.36	
45.00	2.35	2.34	2.33	2.32	2.31	
50.00	2.30	2.29	2.28	2.27	2.26	
55.00	2.25	2.24	2.23	2.21	2.20	
60.00	2.19	2.18	2.17	2.16	2.15	
65.00	2.14	2.13	2.12	2.11	2.11	
70.00	2.10	2.09	2.08	2.07	2.06	
75.00	2.05	2.04	2.03	2.02	2.01	
80.00	2.00	1.99	1.98	1.98	1.97	
85.00	1.96	1.95	1.94	1.93	1.92	
90.00	1.91	1.91	1.90	1.89	1.88	
95.00	1.87	1.86	1.86	1.85	1.84	
100.00	1.83	1.82	1.82	1.81	1.80	
105.00	1.79	1.78	1.78	1.77	1.76	
110.00	1.75	1.75	1.74	1.73	1.72	
115.00	1.71	1.71	1.70	1.69	1.69	
120.00	1.68	1.67	1.67	1.66	1.65	
125.00	1.64	1.64	1.63	1.62	1.62	
130.00	1.61	1.60	1.60	1.59	1.58	
135.00	1.58	1.57	1.56	1.56	1.55	
140.00	1.54	1.54	1.53	1.52	1.52	
145.00	1.51	1.51	1.50	1.49	1.49	

Type.... Pond Routed HYG (total out)
 Name.... BASIN B OUT Tag: A 15yr
 File.... C:\MY DOCUMENTS\AVONDALE HEIGHTS DETENTION.PPW
 Storm... A 15yr Tag: A 15yr

Page 4.03
 Event: A 15yr

WARNING: Hydrograph truncated on right side.

Time min	HYDROGRAPH ORDINATES (cfs)				
	Output Time increment = 1.00 min				
Time on left represents time for first value in each row.					
150.00	1.48	1.47	1.47	1.46	1.46
155.00	1.45	1.44	1.44	1.43	1.43
160.00	1.42	1.41	1.41	1.40	1.40
165.00	1.39	1.39	1.38	1.38	1.37
170.00	1.36	1.36	1.35	1.35	1.34
175.00	1.34	1.33	1.33	1.32	1.32
180.00	1.31	1.31	1.30	1.30	1.29
185.00	1.29	1.28	1.28	1.27	1.27
190.00	1.26	1.26	1.25	1.25	1.24
195.00	1.24	1.23	1.23	1.22	1.22
200.00	1.21	1.21	1.20	1.20	1.19
205.00	1.19	1.18	1.18	1.17	1.17
210.00	1.17	1.16	1.16	1.15	1.15
215.00	1.14	1.14	1.14	1.13	1.13
220.00	1.12	1.12	1.11	1.11	1.11
225.00	1.10	1.10	1.09	1.09	1.09
230.00	1.08	1.08	1.07	1.07	1.07
235.00	1.06	1.06	1.05	1.05	1.05
240.00	1.04	1.04	1.03	1.03	1.03
245.00	1.02	1.02	1.02	1.01	1.01
250.00	1.00	1.00	1.00	.99	.99
255.00	.99	.98	.98	.97	.97
260.00	.97	.96	.96	.96	.95
265.00	.95	.95	.94	.94	.94
270.00	.93	.93	.93	.92	.92
275.00	.92	.91	.91	.91	.90
280.00	.90	.90	.89	.89	.89
285.00	.89	.88	.88	.88	.87
290.00	.87	.87	.86	.86	.86
295.00	.86	.85	.85	.85	.84
300.00	.84	.84	.83	.83	.83
305.00	.83	.82	.82	.82	.82
310.00	.81	.81	.81	.80	.80
315.00	.80	.80	.79	.79	.79
320.00	.78	.78	.78	.78	.77
325.00	.77	.77	.77	.76	.76
330.00	.76	.76	.75	.75	.75
335.00	.75	.74	.74	.74	.73
340.00	.73	.73	.73	.72	.72
345.00	.72	.72	.72	.71	.71
350.00	.71	.71	.70	.70	.70
355.00	.70	.69	.69	.69	.69
360.00	.69	.68	.68	.68	.68
365.00	.68	.67	.67	.67	.67

S/N: f21101d06a84 Bax Engineering Date: 08-12-2002
 PondPack Ver: 7.0 (325) Compute Time: 13:01:23

Type.... Pond Routed HYG (total out)
 Name.... BASIN B OUT Tag: A 15yr
 File.... C:\MY DOCUMENTS\AVONDALE HEIGHTS DETENTION.PPW
 Storm... A 15yr Tag: A 15yr

Page 4.04
 Event: A 15yr

WARNING: Hydrograph truncated on right side.

Time min	HYDROGRAPH ORDINATES (cfs)				
	Output Time increment = 1.00 min				
	Time on left represents time for first value in each row.				
370.00	.66	.66	.66	.66	.66
375.00	.65	.65	.65	.65	.65
380.00	.64	.64	.64	.64	.64
385.00	.63	.63	.63	.63	.63
390.00	.62	.62	.62	.62	.62
395.00	.61	.61	.61	.61	.61
400.00	.61	.60	.60	.60	.60
405.00	.60	.59	.59	.59	.59
410.00	.59	.58	.58	.58	.58
415.00	.58	.58	.57	.57	.57
420.00	.57	.57	.56	.56	.56
425.00	.56	.56	.56	.55	.55
430.00	.55	.55	.55	.55	.54
435.00	.54	.54	.54	.54	.54
440.00	.53	.53	.53	.53	.53
445.00	.53	.52	.52	.52	.52
450.00	.52	.52	.51	.51	.51
455.00	.51	.51	.51	.51	.50
460.00	.50	.50	.50	.50	.50
465.00	.50	.49	.49	.49	.49
470.00	.49	.49	.49	.48	.48
475.00	.48	.48	.48	.48	.48
480.00	.48	.47	.47	.47	.47
485.00	.47	.47	.47	.46	.46
490.00	.46	.46	.46	.46	.46
495.00	.46	.45	.45	.45	.45
500.00	.45	.45	.45	.45	.44
505.00	.44	.44	.44	.44	.44
510.00	.44	.44	.43	.43	.43
515.00	.43	.43	.43	.43	.43
520.00	.43	.42	.42	.42	.42
525.00	.42	.42	.42	.42	.41
530.00	.41	.41	.41	.41	.41
535.00	.41	.41	.41	.40	.40
540.00	.40	.40	.40	.40	.40
545.00	.40	.40	.39	.39	.39
550.00	.39	.39	.39	.39	.39
555.00	.39	.38	.38	.38	.38
560.00	.38	.38	.38	.38	.38
565.00	.38	.37	.37	.37	.37
570.00	.37	.37	.37	.37	.37
575.00	.36	.36	.36	.36	.36
580.00	.36	.36	.36	.36	.36
585.00	.35	.35	.35	.35	.35

S/N: f21101d06a84 Bax Engineering
 PondPack Ver: 7.0 (325) Compute Time: 13:01:23 Date: 08-12-2002

Type.... Pond Routed HYG (total out)
Name.... BASIN B OUT Tag: A 15yr
File.... C:\MY DOCUMENTS\AVONDALE HEIGHTS DETENTION.PPW
Storm... A 15yr Tag: A 15yr

Page 4.05
Event: A 15yr

HYDROGRAPH ORDINATES (cfs)					
Time min	Output Time increment = 1.00 min				
	Time on left represents time for first value in each row.				
590.00	.35	.35	.35	.35	.35
595.00	.35	.34	.34	.34	.34
600.00	.34	.34	.34	.34	.34
605.00	.34	.33	.33	.33	.33
610.00	.33	.33	.33	.33	.33
615.00	.33	.33	.33	.32	.32
620.00	.32	.32	.32	.32	.32
625.00	.32	.32	.32	.32	.32
630.00	.32	.31	.31	.31	.31
635.00	.31	.31	.31	.31	.31
640.00	.31	.31	.31	.31	.31
645.00	.30	.30	.30	.30	.30
650.00	.30	.30	.30	.30	.30
655.00	.30	.30	.30	.30	.29
660.00	.29	.29	.29	.29	.29
665.00	.29	.29	.29	.29	.29
670.00	.29	.29	.29	.29	.28
675.00	.28	.28	.28	.28	.28
680.00	.28	.28	.28	.28	.28
685.00	.28	.28	.28	.28	.27
690.00	.27	.27	.27	.27	.27
695.00	.27	.27	.27	.27	.27
700.00	.27	.27	.27	.27	.26
705.00	.26	.26	.26	.26	.26
710.00	.26	.26	.26	.26	.26
715.00	.26	.26	.26	.26	.26
720.00	.26	.25	.25	.25	.25
725.00	.25	.25	.25	.25	.25
730.00	.25	.25	.25	.25	.25
735.00	.25	.25	.25	.24	.24
740.00	.24	.24	.24	.24	.24
745.00	.24	.24	.24	.24	.24
750.00	.24	.24	.24	.24	.24
755.00	.23	.23	.23	.23	.23
760.00	.23	.23	.23	.23	.23
765.00	.23	.23	.23	.23	.23
770.00	.23	.23	.23	.23	.22
775.00	.22	.22	.22	.22	.22
780.00	.22	.22	.22	.22	.22
785.00	.22	.22	.22	.22	.22
790.00	.22	.22	.22	.21	.21
795.00	.21	.21	.21	.21	.21
800.00	.21	.21	.21	.21	.21
805.00	.21	.21	.21	.21	.21

Type.... Pond Routed HYG (total out)
 Name.... BASIN B OUT Tag: A 15yr
 File.... C:\MY DOCUMENTS\AVONDALE HEIGHTS DETENTION.PPW
 Storm... A 15yr Tag: A 15yr

Page 4.06
 Event: A 15yr

WARNING: Hydrograph truncated on right side.

HYDROGRAPH ORDINATES (cfs)						
Time min	Output Time increment = 1.00 min					
	Time on left represents time for first value in each row.					
810.00	.21	.21	.21	.20	.20	.20
815.00	.20	.20	.20	.20	.20	.20
820.00	.20	.20	.20	.20	.20	.20
825.00	.20	.20	.20	.20	.20	.20
830.00	.20	.20	.20	.20	.20	.19
835.00	.19	.19	.19	.19	.19	.19
840.00	.19	.19	.19	.19	.19	.19
845.00	.19	.19	.19	.19	.19	.19
850.00	.19	.19	.19	.19	.19	.19
855.00	.19	.18	.18	.18	.18	.18
860.00	.18	.18	.18	.18	.18	.18
865.00	.18	.18	.18	.18	.18	.18
870.00	.18	.18	.18	.18	.18	.18
875.00	.18	.18	.18	.18	.18	.18
880.00	.18	.18	.18	.17	.17	.17
885.00	.17	.17	.17	.17	.17	.17
890.00	.17	.17	.17	.17	.17	.17
895.00	.17	.17	.17	.17	.17	.17
900.00	.17	.17	.17	.17	.17	.17
905.00	.17	.17	.17	.17	.17	.17
910.00	.17	.17	.17	.17	.17	.17
915.00	.16	.16	.16	.16	.16	.16
920.00	.16	.16	.16	.16	.16	.16
925.00	.16	.16	.16	.16	.16	.16
930.00	.16	.16	.16	.16	.16	.16
935.00	.16	.16	.16	.16	.16	.16
940.00	.16	.16	.16	.16	.16	.16
945.00	.16	.16	.16	.16	.16	.15
950.00	.15	.15	.15	.15	.15	.15
955.00	.15	.15	.15	.15	.15	.15
960.00	.15	.15	.15	.15	.15	.15
965.00	.15	.15	.15	.15	.15	.15
970.00	.15	.15	.15	.15	.15	.15
975.00	.15	.15	.15	.15	.15	.15
980.00	.15	.15	.15	.15	.15	.15
985.00	.15	.14	.14	.14	.14	.14
990.00	.14	.14	.14	.14	.14	.14
995.00	.14	.14	.14	.14	.14	.14
1000.00	.14	.14	.14	.14	.14	.14
1005.00	.14	.14	.14	.14	.14	.14
1010.00	.14	.14	.14	.14	.14	.14
1015.00	.14	.14	.14	.14	.14	.14
1020.00	.14	.14	.14	.14	.14	.14
1025.00	.13	.13	.13	.13	.13	.13

S/N: f21101d06a84 Bax Engineering Compute Time: 13:01:23 Date: 08-12-2002
 PondPack Ver: 7.0 (325)

Type... Pond Routed HYG (total out)
 Name... BASIN B OUT Tag: A 15yr
 File... C:\MY DOCUMENTS\AVONDALE HEIGHTS DETENTION.PPW
 Storm... A 15yr Tag: A 15yr

WARNING: Hydrograph truncated on right side.

HYDROGRAPH ORDINATES (cfs)						
Time min	Output Time increment = 1.00 min					
	Time on left represents time for first value in each row.					
1030.00	.13	.13	.13	.13	.13	.13
1035.00	.13	.13	.13	.13	.13	.13
1040.00	.13	.13	.13	.13	.13	.13
1045.00	.13	.13	.13	.13	.13	.13
1050.00	.13	.13	.13	.13	.13	.13
1055.00	.13	.13	.13	.13	.13	.13
1060.00	.13	.13	.13	.13	.13	.13
1065.00	.13	.12	.12	.12	.12	.12
1070.00	.12	.12	.12	.12	.12	.12
1075.00	.12	.12	.12	.12	.12	.12
1080.00	.12	.12	.12	.12	.12	.12
1085.00	.12	.12	.12	.12	.12	.12
1090.00	.12	.12	.12	.12	.12	.12
1095.00	.12	.12	.12	.12	.12	.12
1100.00	.12	.12	.12	.12	.12	.12
1105.00	.12	.12	.12	.12	.12	.12
1110.00	.12	.12	.11	.11	.11	.11
1115.00	.11	.11	.11	.11	.11	.11
1120.00	.11	.11	.11	.11	.11	.11
1125.00	.11	.11	.11	.11	.11	.11
1130.00	.11	.11	.11	.11	.11	.11
1135.00	.11	.11	.11	.11	.11	.11
1140.00	.11	.11	.11	.11	.11	.11
1145.00	.11	.11	.11	.11	.11	.11
1150.00	.11	.11	.11	.11	.11	.11
1155.00	.11	.11	.11	.11	.11	.11
1160.00	.11	.10	.10	.10	.10	.10
1165.00	.10	.10	.10	.10	.10	.10
1170.00	.10	.10	.10	.10	.10	.10
1175.00	.10	.10	.10	.10	.10	.10
1180.00	.10	.10	.10	.10	.10	.10
1185.00	.10	.10	.10	.10	.10	.10
1190.00	.10	.10	.10	.10	.10	.10
1195.00	.10	.10	.10	.10	.10	.10
1200.00	.10	.10	.10	.10	.10	.10
1205.00	.10	.10	.10	.10	.10	.10
1210.00	.10	.10	.10	.10	.10	.10
1215.00	.10	.09	.09	.09	.09	.09
1220.00	.09	.09	.09	.09	.09	.09
1225.00	.09	.09	.09	.09	.09	.09
1230.00	.09	.09	.09	.09	.09	.09
1235.00	.09	.09	.09	.09	.09	.09
1240.00	.09	.09	.09	.09	.09	.09
1245.00	.09	.09	.09	.09	.09	.09

Type... Pond Routed HYG (total out)
 Name... BASIN B OUT Tag: A 15yr
 File... C:\MY DOCUMENTS\AVONDALE HEIGHTS DETENTION.PPW
 Storm... A 15yr Tag: A 15yr

WARNING: Hydrograph truncated on right side.

Time min	HYDROGRAPH ORDINATES (cfs)				
	Output Time increment = 1.00 min				
Time on left represents time for first value in each row.					
1250.00	.09	.09	.09	.09	.09
1255.00	.09	.09	.09	.09	.09
1260.00	.09	.09	.09	.09	.09
1265.00	.09	.09	.09	.09	.09
1270.00	.09	.09	.09	.09	.09
1275.00	.09	.08	.08	.08	.08
1280.00	.08	.08	.08	.08	.08
1285.00	.08	.08	.08	.08	.08
1290.00	.08	.08	.08	.08	.08
1295.00	.08	.08	.08	.08	.08
1300.00	.08	.08	.08	.08	.08
1305.00	.08	.08	.08	.08	.08
1310.00	.08	.08	.08	.08	.08
1315.00	.08	.08	.08	.08	.08
1320.00	.08	.08	.08	.08	.08
1325.00	.08	.08	.08	.08	.08
1330.00	.08	.08	.08	.08	.08
1335.00	.08	.08	.08	.08	.08
1340.00	.08	.08	.08	.08	.08
1345.00	.07	.07	.07	.07	.07
1350.00	.07	.07	.07	.07	.07
1355.00	.07	.07	.07	.07	.07
1360.00	.07	.07	.07	.07	.07
1365.00	.07	.07	.07	.07	.07
1370.00	.07	.07	.07	.07	.07
1375.00	.07	.07	.07	.07	.07
1380.00	.07	.07	.07	.07	.07
1385.00	.07	.07	.07	.07	.07
1390.00	.07	.07	.07	.07	.07
1395.00	.07	.07	.07	.07	.07
1400.00	.07	.07	.07	.07	.07
1405.00	.07	.07	.07	.07	.07
1410.00	.07	.07	.07	.07	.07
1415.00	.07	.07	.07	.07	.07
1420.00	.07	.07	.06	.06	.06
1425.00	.06	.06	.06	.06	.06
1430.00	.06	.06	.06	.06	.06
1435.00	.06	.06	.06	.06	.06
1440.00	.06	.06	.06	.06	.06
1445.00	.06	.06	.06	.06	.06
1450.00	.06	.06	.06	.06	.06
1455.00	.06	.06	.06	.06	.06
1460.00	.06	.06	.06	.06	.06
1465.00	.06	.06	.06	.06	.06

Type... Pond Routed HYG (total out)
 Name... BASIN B OUT Tag: A 15yr
 File... C:\MY DOCUMENTS\AVONDALE HEIGHTS DETENTION.PPW
 Storm... A 15yr Tag: A 15yr

WARNING: Hydrograph truncated on right side.

HYDROGRAPH ORDINATES (cfs)						
Time min	Output Time increment = 1.00 min					
	Time on left represents time for first value in each row.					
1470.00	.06	.06	.06	.06	.06	.06
1475.00	.06	.06	.06	.06	.06	.06
1480.00	.06	.06	.06	.06	.06	.06
1485.00	.06	.06	.06	.06	.06	.06
1490.00	.06	.06	.06	.06	.06	.06
1495.00	.06	.06	.06	.06	.06	.06
1500.00	.06	.06	.06	.06	.06	.06
1505.00	.06	.06	.06	.06	.06	.06
1510.00	.06	.06	.06	.06	.06	.06
1515.00	.06	.06	.06	.06	.06	.06
1520.00	.06	.06	.06	.06	.06	.06
1525.00	.06	.06	.06	.06	.06	.06
1530.00	.06	.06	.06	.06	.06	.06
1535.00	.06	.06	.06	.06	.06	.06
1540.00	.06	.06	.06	.06	.06	.06
1545.00	.06	.06	.06	.06	.06	.06
1550.00	.06	.06	.06	.06	.06	.06
1555.00	.06	.06	.06	.06	.06	.06
1560.00	.06	.06	.06	.06	.06	.06
1565.00	.06	.06	.06	.06	.06	.06
1570.00	.06	.06	.06	.06	.06	.06
1575.00	.06	.06	.06	.06	.05	.05
1580.00	.05	.05	.05	.05	.05	.05
1585.00	.05	.05	.05	.05	.05	.05
1590.00	.05	.05	.05	.05	.05	.05
1595.00	.05	.05	.05	.05	.05	.05
1600.00	.05	.05	.05	.05	.05	.05
1605.00	.05	.05	.05	.05	.05	.05
1610.00	.05	.05	.05	.05	.05	.05
1615.00	.05	.05	.05	.05	.05	.05
1620.00	.05	.05	.05	.05	.05	.05
1625.00	.05	.05	.05	.05	.05	.05
1630.00	.05	.05	.05	.05	.05	.05
1635.00	.05	.05	.05	.05	.05	.05
1640.00	.05	.05	.05	.05	.05	.05
1645.00	.05	.05	.05	.05	.05	.05
1650.00	.05	.05	.05	.05	.05	.05
1655.00	.05	.05	.05	.05	.05	.05
1660.00	.05	.05	.05	.05	.05	.05
1665.00	.05	.05	.05	.05	.05	.05
1670.00	.05	.05	.05	.05	.05	.05
1675.00	.05	.05	.05	.05	.05	.05
1680.00	.05	.05	.05	.05	.05	.05
1685.00	.05	.05	.05	.05	.05	.05

Type.... Pond Routed HYG (total out)
 Name.... BASIN B OUT Tag: A 15yr
 File.... C:\MY DOCUMENTS\AVONDALE HEIGHTS DETENTION.PPW
 Storm... A 15yr Tag: A 15yr

Page 4.10
 Event: A 15yr

WARNING: Hydrograph truncated on right side.

HYDROGRAPH ORDINATES (cfs)						
Time min	Output Time increment = 1.00 min					
	Time on left represents time for first value in each row.					
1690.00	.05	.05	.05	.05	.05	.05
1695.00	.05	.05	.05	.05	.05	.05
1700.00	.05	.05	.05	.05	.05	.05
1705.00	.05	.05	.05	.05	.05	.05
1710.00	.05	.05	.05	.05	.05	.05
1715.00	.05	.05	.05	.05	.05	.05
1720.00	.05	.05	.05	.05	.05	.05
1725.00	.05	.05	.05	.05	.05	.05
1730.00	.05	.05	.05	.05	.05	.05
1735.00	.05	.05	.05	.05	.05	.05
1740.00	.05	.05	.05	.05	.05	.05
1745.00	.05	.05	.05	.05	.05	.05
1750.00	.05	.05	.05	.05	.05	.05
1755.00	.05	.05	.05	.05	.05	.05
1760.00	.05	.05	.05	.05	.05	.05
1765.00	.05	.05	.05	.05	.05	.05
1770.00	.05	.05	.05	.05	.05	.05
1775.00	.05	.04	.04	.04	.04	.04
1780.00	.04	.04	.04	.04	.04	.04
1785.00	.04	.04	.04	.04	.04	.04
1790.00	.04	.04	.04	.04	.04	.04
1795.00	.04	.04	.04	.04	.04	.04
1800.00	.04	.04	.04	.04	.04	.04
1805.00	.04	.04	.04	.04	.04	.04
1810.00	.04	.04	.04	.04	.04	.04
1815.00	.04	.04	.04	.04	.04	.04
1820.00	.04	.04	.04	.04	.04	.04
1825.00	.04	.04	.04	.04	.04	.04
1830.00	.04	.04	.04	.04	.04	.04
1835.00	.04	.04	.04	.04	.04	.04
1840.00	.04	.04	.04	.04	.04	.04
1845.00	.04	.04	.04	.04	.04	.04
1850.00	.04	.04	.04	.04	.04	.04
1855.00	.04	.04	.04	.04	.04	.04
1860.00	.04	.04	.04	.04	.04	.04
1865.00	.04	.04	.04	.04	.04	.04
1870.00	.04	.04	.04	.04	.04	.04
1875.00	.04	.04	.04	.04	.04	.04
1880.00	.04	.04	.04	.04	.04	.04
1885.00	.04	.04	.04	.04	.04	.04
1890.00	.04	.04	.04	.04	.04	.04
1895.00	.04	.04	.04	.04	.04	.04
1900.00	.04	.04	.04	.04	.04	.04
1905.00	.04	.04	.04	.04	.04	.04

S/N: f21101d06a84 Bax Engineering
 PondPack Ver: 7.0 (325) Compute Time: 13:01:23 Date: 08-12-2002

Type... Pond Routed HYG (total out)
 Name... BASIN B OUT Tag: A 15yr
 File... C:\MY DOCUMENTS\AVONDALE HEIGHTS DETENTION.PPW
 Storm... A 15yr Tag: A 15yr

WARNING: Hydrograph truncated on right side.

HYDROGRAPH ORDINATES (cfs)						
Time min	Output Time increment = 1.00 min					
	Time on left represents time for first value in each row.					
1910.00	.04	.04	.04	.04	.04	.04
1915.00	.04	.04	.04	.04	.04	.04
1920.00	.04	.04	.04	.04	.04	.04
1925.00	.04	.04	.04	.04	.04	.04
1930.00	.04	.04	.04	.04	.04	.04
1935.00	.04	.04	.04	.04	.04	.04
1940.00	.04	.04	.04	.04	.04	.04
1945.00	.04	.04	.04	.04	.04	.04
1950.00	.04	.04	.04	.04	.04	.04
1955.00	.04	.04	.04	.04	.04	.04
1960.00	.04	.04	.04	.04	.04	.04
1965.00	.04	.04	.04	.04	.04	.04
1970.00	.04	.04	.04	.04	.04	.04
1975.00	.04	.04	.04	.04	.04	.04
1980.00	.04	.04	.04	.04	.04	.04
1985.00	.04	.04	.04	.04	.04	.04
1990.00	.04	.04	.04	.04	.04	.04
1995.00	.04	.04	.04	.04	.04	.04
2000.00	.04					

Type.... Pond Routing Summary
Name.... BASIN B OUT Tag: B 25yr
File.... C:\MY DOCUMENTS\AVONDALE HEIGHTS DETENTION.PPW
Storm... B 25yr Tag: B 25yr

Page 4.12
Event: B 25yr

LEVEL POOL ROUTING SUMMARY

HYG Dir = C:\MY DOCUMENTS\
Inflow HYG file = NONE STORED - BASIN B IN B 25yr
Outflow HYG file = NONE STORED - BASIN B OUT B 25yr

Pond Node Data = BASIN B
Pond Volume Data = BASIN B
Pond Outlet Data = OVERFLOW 44

No Infiltration

INITIAL CONDITIONS

Starting WS Elev = 498.00 ft
Starting Volume = 0 cu.ft
Starting Outflow = .00 cfs
Starting Infiltr. = .00 cfs
Starting Total Qout = .00 cfs
Time Increment = 1.00 min

INFLOW/OUTFLOW HYDROGRAPH SUMMARY

=====
Peak Inflow = 49.29 cfs at 5.00 min
Peak Outflow = 6.86 cfs at 24.00 min

Peak Elevation = 499.43 ft
Peak Storage = 56259 cu.ft
=====

MASS BALANCE (cu.ft)

+ Initial Vol = 0
+ HYG Vol IN = 59250
- Infiltration = 0
- HYG Vol OUT = 57029
- Retained Vol = 2217

Unrouted Vol = -3 cu.ft (.006% of Inflow Volume)

WARNING: Outflow hydrograph truncated on right side.

Type.... Pond Routed HYG (total out)
 Name.... BASIN B OUT Tag: B 25yr
 File.... C:\MY DOCUMENTS\AVONDALE HEIGHTS DETENTION.PPW
 Storm... B 25yr Tag: B 25yr

POND ROUTED TOTAL OUTFLOW HYG...

HYG file =
 HYG ID = BASIN B OUT
 HYG Tag = B 25yr

 Peak Discharge = 6.86 cfs
 Time to Peak = 24.00 min
 HYG Volume = 57029 cu.ft

WARNING: Hydrograph truncated on right side.

Time min	HYDROGRAPH ORDINATES (cfs)				
	Output Time increment = 1.00 min				
Time on left represents time for first value in each row.					
.00	.00	.00	.02	.04	.09
5.00	.18	.29	.42	.56	.71
10.00	.88	1.06	1.24	1.43	1.63
15.00	1.84	2.05	2.26	2.49	2.93
20.00	3.85	5.00	5.91	6.56	6.86
25.00	6.79	6.54	6.30	6.08	5.89
30.00	5.71	5.54	5.37	5.21	5.05
35.00	4.90	4.75	4.61	4.47	4.33
40.00	4.20	4.07	3.97	3.89	3.81
45.00	3.74	3.66	3.59	3.52	3.45
50.00	3.38	3.31	3.25	3.18	3.12
55.00	3.06	3.00	2.94	2.88	2.82
60.00	2.77	2.71	2.66	2.63	2.62
65.00	2.61	2.60	2.58	2.57	2.56
70.00	2.55	2.53	2.52	2.51	2.50
75.00	2.49	2.47	2.46	2.45	2.44
80.00	2.43	2.42	2.40	2.39	2.38
85.00	2.37	2.36	2.35	2.34	2.32
90.00	2.31	2.30	2.29	2.28	2.27
95.00	2.26	2.25	2.24	2.23	2.22
100.00	2.21	2.20	2.19	2.18	2.17
105.00	2.16	2.15	2.14	2.13	2.12
110.00	2.11	2.10	2.09	2.08	2.07
115.00	2.06	2.05	2.04	2.03	2.02
120.00	2.01	2.01	2.00	1.99	1.98
125.00	1.97	1.96	1.95	1.94	1.94
130.00	1.93	1.92	1.91	1.90	1.89
135.00	1.88	1.88	1.87	1.86	1.85
140.00	1.84	1.84	1.83	1.82	1.81
145.00	1.80	1.80	1.79	1.78	1.77

Type.... Pond Routed HYG (total out)
 Name.... BASIN B OUT Tag: B 25yr
 File.... C:\MY DOCUMENTS\AVONDALE HEIGHTS DETENTION.PPW
 Storm... B 25yr Tag: B 25yr

WARNING: Hydrograph truncated on right side.

HYDROGRAPH ORDINATES (cfs)					
Time min	Output Time increment = 1.00 min				
	Time on left represents time for first value in each row.				
150.00	1.76	1.76	1.75	1.74	1.73
155.00	1.73	1.72	1.71	1.70	1.70
160.00	1.69	1.68	1.68	1.67	1.66
165.00	1.65	1.65	1.64	1.63	1.63
170.00	1.62	1.61	1.61	1.60	1.59
175.00	1.59	1.58	1.57	1.57	1.56
180.00	1.55	1.55	1.54	1.53	1.53
185.00	1.52	1.51	1.51	1.50	1.50
190.00	1.49	1.48	1.48	1.47	1.46
195.00	1.46	1.45	1.45	1.44	1.43
200.00	1.43	1.42	1.42	1.41	1.41
205.00	1.40	1.39	1.39	1.38	1.38
210.00	1.37	1.37	1.36	1.36	1.35
215.00	1.35	1.34	1.34	1.33	1.32
220.00	1.32	1.31	1.31	1.30	1.30
225.00	1.29	1.29	1.28	1.28	1.27
230.00	1.27	1.26	1.26	1.25	1.25
235.00	1.24	1.24	1.23	1.23	1.22
240.00	1.22	1.21	1.21	1.20	1.20
245.00	1.19	1.19	1.19	1.18	1.18
250.00	1.17	1.17	1.16	1.16	1.15
255.00	1.15	1.15	1.14	1.14	1.13
260.00	1.13	1.12	1.12	1.12	1.11
265.00	1.11	1.10	1.10	1.10	1.09
270.00	1.09	1.08	1.08	1.08	1.07
275.00	1.07	1.06	1.06	1.06	1.05
280.00	1.05	1.04	1.04	1.04	1.03
285.00	1.03	1.02	1.02	1.02	1.01
290.00	1.01	1.01	1.00	1.00	.99
295.00	.99	.99	.98	.98	.98
300.00	.97	.97	.97	.96	.96
305.00	.95	.95	.95	.94	.94
310.00	.94	.93	.93	.93	.92
315.00	.92	.92	.91	.91	.91
320.00	.91	.90	.90	.90	.89
325.00	.89	.89	.88	.88	.88
330.00	.87	.87	.87	.87	.86
335.00	.86	.86	.85	.85	.85
340.00	.84	.84	.84	.84	.83
345.00	.83	.83	.82	.82	.82
350.00	.82	.81	.81	.81	.81
355.00	.80	.80	.80	.79	.79
360.00	.79	.79	.78	.78	.78
365.00	.78	.77	.77	.77	.76

Type.... Pond Routed HYG (total out)
 Name.... BASIN B OUT Tag: B 25yr
 File.... C:\MY DOCUMENTS\AVONDALE HEIGHTS DETENTION.PPW
 Storm... B 25yr Tag: B 25yr

WARNING: Hydrograph truncated on right side.

HYDROGRAPH ORDINATES (cfs)						
Time min	Output Time increment = 1.00 min					
	Time on left represents time for first value in each row.					
370.00	.76	.76	.76	.75	.75	.75
375.00	.75	.75	.74	.74	.74	.74
380.00	.74	.73	.73	.73	.73	.73
385.00	.72	.72	.72	.72	.71	.71
390.00	.71	.71	.71	.70	.70	.70
395.00	.70	.70	.69	.69	.69	.69
400.00	.69	.69	.68	.68	.68	.68
405.00	.68	.68	.67	.67	.67	.67
410.00	.67	.67	.66	.66	.66	.66
415.00	.66	.66	.65	.65	.65	.65
420.00	.65	.65	.64	.64	.64	.64
425.00	.64	.64	.63	.63	.63	.63
430.00	.63	.63	.62	.62	.62	.62
435.00	.62	.62	.61	.61	.61	.61
440.00	.61	.61	.60	.60	.60	.60
445.00	.60	.60	.59	.59	.59	.59
450.00	.59	.59	.59	.58	.58	.58
455.00	.58	.58	.58	.57	.57	.57
460.00	.57	.57	.57	.57	.56	.56
465.00	.56	.56	.56	.56	.56	.56
470.00	.55	.55	.55	.55	.55	.55
475.00	.54	.54	.54	.54	.54	.54
480.00	.54	.53	.53	.53	.53	.53
485.00	.53	.53	.52	.52	.52	.52
490.00	.52	.52	.52	.51	.51	.51
495.00	.51	.51	.51	.51	.51	.51
500.00	.50	.50	.50	.50	.50	.50
505.00	.50	.50	.49	.49	.49	.49
510.00	.49	.49	.49	.49	.48	.48
515.00	.48	.48	.48	.48	.48	.48
520.00	.48	.48	.47	.47	.47	.47
525.00	.47	.47	.47	.47	.47	.47
530.00	.46	.46	.46	.46	.46	.46
535.00	.46	.46	.45	.45	.45	.45
540.00	.45	.45	.45	.45	.45	.45
545.00	.44	.44	.44	.44	.44	.44
550.00	.44	.44	.44	.44	.43	.43
555.00	.43	.43	.43	.43	.43	.43
560.00	.43	.43	.42	.42	.42	.42
565.00	.42	.42	.42	.42	.42	.42
570.00	.42	.41	.41	.41	.41	.41
575.00	.41	.41	.41	.41	.40	.40
580.00	.40	.40	.40	.40	.40	.40
585.00	.40	.40	.40	.39	.39	.39

Type.... Pond Routed HYG (total out)
 Name.... BASIN B OUT Tag: B 25yr
 File.... C:\MY DOCUMENTS\AVONDALE HEIGHTS DETENTION.PPW
 Storm... B 25yr Tag: B 25yr

WARNING: Hydrograph truncated on right side.

HYDROGRAPH ORDINATES (cfs)						
Time min	Output Time increment = 1.00 min					
	Time on left represents time for first value in each row.					
590.00	.39	.39	.39	.39	.39	.39
595.00	.39	.39	.39	.38	.38	.38
600.00	.38	.38	.38	.38	.38	.38
605.00	.38	.38	.37	.37	.37	.37
610.00	.37	.37	.37	.37	.37	.37
615.00	.37	.37	.36	.36	.36	.36
620.00	.36	.36	.36	.36	.36	.36
625.00	.36	.36	.35	.35	.35	.35
630.00	.35	.35	.35	.35	.35	.35
635.00	.35	.35	.34	.34	.34	.34
640.00	.34	.34	.34	.34	.34	.34
645.00	.34	.34	.34	.33	.33	.33
650.00	.33	.33	.33	.33	.33	.33
655.00	.33	.33	.33	.33	.32	.32
660.00	.32	.32	.32	.32	.32	.32
665.00	.32	.32	.32	.32	.32	.32
670.00	.32	.32	.32	.31	.31	.31
675.00	.31	.31	.31	.31	.31	.31
680.00	.31	.31	.31	.31	.31	.31
685.00	.31	.30	.30	.30	.30	.30
690.00	.30	.30	.30	.30	.30	.30
695.00	.30	.30	.30	.30	.30	.30
700.00	.29	.29	.29	.29	.29	.29
705.00	.29	.29	.29	.29	.29	.29
710.00	.29	.29	.29	.29	.29	.29
715.00	.28	.28	.28	.28	.28	.28
720.00	.28	.28	.28	.28	.28	.28
725.00	.28	.28	.28	.28	.28	.28
730.00	.27	.27	.27	.27	.27	.27
735.00	.27	.27	.27	.27	.27	.27
740.00	.27	.27	.27	.27	.27	.27
745.00	.27	.26	.26	.26	.26	.26
750.00	.26	.26	.26	.26	.26	.26
755.00	.26	.26	.26	.26	.26	.26
760.00	.26	.26	.25	.25	.25	.25
765.00	.25	.25	.25	.25	.25	.25
770.00	.25	.25	.25	.25	.25	.25
775.00	.25	.25	.25	.25	.24	.24
780.00	.24	.24	.24	.24	.24	.24
785.00	.24	.24	.24	.24	.24	.24
790.00	.24	.24	.24	.24	.24	.24
795.00	.24	.24	.23	.23	.23	.23
800.00	.23	.23	.23	.23	.23	.23
805.00	.23	.23	.23	.23	.23	.23

Type.... Pond Routed HYG (total out)
 Name.... BASIN B OUT Tag: B 25yr
 File.... C:\MY DOCUMENTS\AVONDALE HEIGHTS DETENTION.PPW
 Storm... B 25yr Tag: B 25yr

Page 4.17
 Event: B 25yr

WARNING: Hydrograph truncated on right side.

HYDROGRAPH ORDINATES (cfs)						
Time min	Output Time increment = 1.00 min					
	Time on left represents time for first value in each row.					
810.00	.23	.23	.23	.23	.23	.23
815.00	.22	.22	.22	.22	.22	.22
820.00	.22	.22	.22	.22	.22	.22
825.00	.22	.22	.22	.22	.22	.22
830.00	.22	.22	.22	.22	.22	.21
835.00	.21	.21	.21	.21	.21	.21
840.00	.21	.21	.21	.21	.21	.21
845.00	.21	.21	.21	.21	.21	.21
850.00	.21	.21	.21	.21	.21	.20
855.00	.20	.20	.20	.20	.20	.20
860.00	.20	.20	.20	.20	.20	.20
865.00	.20	.20	.20	.20	.20	.20
870.00	.20	.20	.20	.20	.20	.20
875.00	.20	.19	.19	.19	.19	.19
880.00	.19	.19	.19	.19	.19	.19
885.00	.19	.19	.19	.19	.19	.19
890.00	.19	.19	.19	.19	.19	.19
895.00	.19	.19	.19	.19	.18	.18
900.00	.18	.18	.18	.18	.18	.18
905.00	.18	.18	.18	.18	.18	.18
910.00	.18	.18	.18	.18	.18	.18
915.00	.18	.18	.18	.18	.18	.18
920.00	.18	.18	.18	.18	.18	.18
925.00	.17	.17	.17	.17	.17	.17
930.00	.17	.17	.17	.17	.17	.17
935.00	.17	.17	.17	.17	.17	.17
940.00	.17	.17	.17	.17	.17	.17
945.00	.17	.17	.17	.17	.17	.17
950.00	.17	.17	.17	.17	.17	.17
955.00	.17	.17	.16	.16	.16	.16
960.00	.16	.16	.16	.16	.16	.16
965.00	.16	.16	.16	.16	.16	.16
970.00	.16	.16	.16	.16	.16	.16
975.00	.16	.16	.16	.16	.16	.16
980.00	.16	.16	.16	.16	.16	.16
985.00	.16	.16	.16	.16	.16	.16
990.00	.16	.15	.15	.15	.15	.15
995.00	.15	.15	.15	.15	.15	.15
1000.00	.15	.15	.15	.15	.15	.15
1005.00	.15	.15	.15	.15	.15	.15
1010.00	.15	.15	.15	.15	.15	.15
1015.00	.15	.15	.15	.15	.15	.15
1020.00	.15	.15	.15	.15	.15	.15
1025.00	.15	.15	.14	.14	.14	.14

S/N: f21101d06a84 Bax Engineering Compute Time: 13:01:23 Date: 08-12-2002
 PondPack Ver: 7.0 (325)

Type.... Pond Routed HYG (total out)
 Name.... BASIN B OUT Tag: B 25yr
 File.... C:\MY DOCUMENTS\AVONDALE HEIGHTS DETENTION.PPW
 Storm... B 25yr Tag: B 25yr

WARNING: Hydrograph truncated on right side.

HYDROGRAPH ORDINATES (cfs)						
Output Time increment = 1.00 min						
Time min	Time on left represents time for first value in each row.					
1030.00	.14	.14	.14	.14	.14	.14
1035.00	.14	.14	.14	.14	.14	.14
1040.00	.14	.14	.14	.14	.14	.14
1045.00	.14	.14	.14	.14	.14	.14
1050.00	.14	.14	.14	.14	.14	.14
1055.00	.14	.14	.14	.14	.14	.14
1060.00	.14	.14	.14	.14	.14	.14
1065.00	.14	.13	.13	.13	.13	.13
1070.00	.13	.13	.13	.13	.13	.13
1075.00	.13	.13	.13	.13	.13	.13
1080.00	.13	.13	.13	.13	.13	.13
1085.00	.13	.13	.13	.13	.13	.13
1090.00	.13	.13	.13	.13	.13	.13
1095.00	.13	.13	.13	.13	.13	.13
1100.00	.13	.13	.13	.13	.13	.13
1105.00	.13	.13	.13	.12	.12	.12
1110.00	.12	.12	.12	.12	.12	.12
1115.00	.12	.12	.12	.12	.12	.12
1120.00	.12	.12	.12	.12	.12	.12
1125.00	.12	.12	.12	.12	.12	.12
1130.00	.12	.12	.12	.12	.12	.12
1135.00	.12	.12	.12	.12	.12	.12
1140.00	.12	.12	.12	.12	.12	.12
1145.00	.12	.12	.12	.12	.12	.12
1150.00	.12	.12	.12	.11	.11	.11
1155.00	.11	.11	.11	.11	.11	.11
1160.00	.11	.11	.11	.11	.11	.11
1165.00	.11	.11	.11	.11	.11	.11
1170.00	.11	.11	.11	.11	.11	.11
1175.00	.11	.11	.11	.11	.11	.11
1180.00	.11	.11	.11	.11	.11	.11
1185.00	.11	.11	.11	.11	.11	.11
1190.00	.11	.11	.11	.11	.11	.11
1195.00	.11	.11	.11	.11	.11	.11
1200.00	.11	.11	.11	.10	.10	.10
1205.00	.10	.10	.10	.10	.10	.10
1210.00	.10	.10	.10	.10	.10	.10
1215.00	.10	.10	.10	.10	.10	.10
1220.00	.10	.10	.10	.10	.10	.10
1225.00	.10	.10	.10	.10	.10	.10
1230.00	.10	.10	.10	.10	.10	.10
1235.00	.10	.10	.10	.10	.10	.10
1240.00	.10	.10	.10	.10	.10	.10
1245.00	.10	.10	.10	.10	.10	.10

Type.... Pond Routed HYG (total out)
 Name.... BASIN B OUT Tag: B 25yr
 File.... C:\MY DOCUMENTS\AVONDALE HEIGHTS DETENTION.PPW
 Storm... B 25yr Tag: B 25yr

Page 4.19
 Event: B 25yr

WARNING: Hydrograph truncated on right side.

HYDROGRAPH ORDINATES (cfs)						
Time min	Output Time increment = 1.00 min					
	Time on left represents time for first value in each row.					
1250.00	.10	.10	.10	.10	.10	.10
1255.00	.10	.10	.09	.09	.09	.09
1260.00	.09	.09	.09	.09	.09	.09
1265.00	.09	.09	.09	.09	.09	.09
1270.00	.09	.09	.09	.09	.09	.09
1275.00	.09	.09	.09	.09	.09	.09
1280.00	.09	.09	.09	.09	.09	.09
1285.00	.09	.09	.09	.09	.09	.09
1290.00	.09	.09	.09	.09	.09	.09
1295.00	.09	.09	.09	.09	.09	.09
1300.00	.09	.09	.09	.09	.09	.09
1305.00	.09	.09	.09	.09	.09	.09
1310.00	.09	.09	.09	.09	.09	.09
1315.00	.09	.09	.09	.08	.08	.08
1320.00	.08	.08	.08	.08	.08	.08
1325.00	.08	.08	.08	.08	.08	.08
1330.00	.08	.08	.08	.08	.08	.08
1335.00	.08	.08	.08	.08	.08	.08
1340.00	.08	.08	.08	.08	.08	.08
1345.00	.08	.08	.08	.08	.08	.08
1350.00	.08	.08	.08	.08	.08	.08
1355.00	.08	.08	.08	.08	.08	.08
1360.00	.08	.08	.08	.08	.08	.08
1365.00	.08	.08	.08	.08	.08	.08
1370.00	.08	.08	.08	.08	.08	.08
1375.00	.08	.08	.08	.08	.08	.08
1380.00	.08	.08	.08	.08	.08	.08
1385.00	.08	.07	.07	.07	.07	.07
1390.00	.07	.07	.07	.07	.07	.07
1395.00	.07	.07	.07	.07	.07	.07
1400.00	.07	.07	.07	.07	.07	.07
1405.00	.07	.07	.07	.07	.07	.07
1410.00	.07	.07	.07	.07	.07	.07
1415.00	.07	.07	.07	.07	.07	.07
1420.00	.07	.07	.07	.07	.07	.07
1425.00	.07	.07	.07	.07	.07	.07
1430.00	.07	.07	.07	.07	.07	.07
1435.00	.07	.07	.07	.07	.07	.07
1440.00	.07	.07	.07	.07	.07	.07
1445.00	.07	.07	.07	.07	.07	.07
1450.00	.07	.07	.07	.07	.07	.07
1455.00	.07	.07	.07	.07	.07	.07
1460.00	.07	.07	.07	.07	.07	.06
1465.00	.06	.06	.06	.06	.06	.06

Type.... Pond Routed HYG (total out)
 Name.... BASIN B OUT Tag: B 25yr
 File.... C:\MY DOCUMENTS\AVONDALE HEIGHTS DETENTION.PPW
 Storm... B 25yr Tag: B 25yr

WARNING: Hydrograph truncated on right side.

HYDROGRAPH ORDINATES (cfs)						
Time min	Output Time increment = 1.00 min					
	Time on left represents time for first value in each row.					
1470.00	.06	.06	.06	.06	.06	.06
1475.00	.06	.06	.06	.06	.06	.06
1480.00	.06	.06	.06	.06	.06	.06
1485.00	.06	.06	.06	.06	.06	.06
1490.00	.06	.06	.06	.06	.06	.06
1495.00	.06	.06	.06	.06	.06	.06
1500.00	.06	.06	.06	.06	.06	.06
1505.00	.06	.06	.06	.06	.06	.06
1510.00	.06	.06	.06	.06	.06	.06
1515.00	.06	.06	.06	.06	.06	.06
1520.00	.06	.06	.06	.06	.06	.06
1525.00	.06	.06	.06	.06	.06	.06
1530.00	.06	.06	.06	.06	.06	.06
1535.00	.06	.06	.06	.06	.06	.06
1540.00	.06	.06	.06	.06	.06	.06
1545.00	.06	.06	.06	.06	.06	.06
1550.00	.06	.06	.06	.06	.06	.06
1555.00	.06	.06	.06	.06	.06	.06
1560.00	.06	.06	.06	.06	.06	.06
1565.00	.06	.06	.06	.06	.06	.06
1570.00	.06	.06	.06	.06	.06	.06
1575.00	.06	.06	.06	.06	.06	.06
1580.00	.06	.06	.06	.06	.06	.06
1585.00	.06	.06	.06	.06	.06	.06
1590.00	.06	.06	.06	.06	.06	.06
1595.00	.06	.06	.06	.06	.06	.06
1600.00	.06	.06	.06	.06	.06	.06
1605.00	.06	.06	.06	.06	.06	.06
1610.00	.06	.06	.06	.06	.06	.06
1615.00	.06	.06	.06	.06	.06	.05
1620.00	.05	.05	.05	.05	.05	.05
1625.00	.05	.05	.05	.05	.05	.05
1630.00	.05	.05	.05	.05	.05	.05
1635.00	.05	.05	.05	.05	.05	.05
1640.00	.05	.05	.05	.05	.05	.05
1645.00	.05	.05	.05	.05	.05	.05
1650.00	.05	.05	.05	.05	.05	.05
1655.00	.05	.05	.05	.05	.05	.05
1660.00	.05	.05	.05	.05	.05	.05
1665.00	.05	.05	.05	.05	.05	.05
1670.00	.05	.05	.05	.05	.05	.05
1675.00	.05	.05	.05	.05	.05	.05
1680.00	.05	.05	.05	.05	.05	.05
1685.00	.05	.05	.05	.05	.05	.05

Type... Pond Routed HYG (total out)
 Name... BASIN B OUT Tag: B 25yr
 File... C:\MY DOCUMENTS\AVONDALE HEIGHTS DETENTION.PPW
 Storm... B 25yr Tag: B 25yr

WARNING: Hydrograph truncated on right side.

HYDROGRAPH ORDINATES (cfs)						
Time min	Output Time increment = 1.00 min					
	Time on left represents time for first value in each row.					
1690.00	.05	.05	.05	.05	.05	.05
1695.00	.05	.05	.05	.05	.05	.05
1700.00	.05	.05	.05	.05	.05	.05
1705.00	.05	.05	.05	.05	.05	.05
1710.00	.05	.05	.05	.05	.05	.05
1715.00	.05	.05	.05	.05	.05	.05
1720.00	.05	.05	.05	.05	.05	.05
1725.00	.05	.05	.05	.05	.05	.05
1730.00	.05	.05	.05	.05	.05	.05
1735.00	.05	.05	.05	.05	.05	.05
1740.00	.05	.05	.05	.05	.05	.05
1745.00	.05	.05	.05	.05	.05	.05
1750.00	.05	.05	.05	.05	.05	.05
1755.00	.05	.05	.05	.05	.05	.05
1760.00	.05	.05	.05	.05	.05	.05
1765.00	.05	.05	.05	.05	.05	.05
1770.00	.05	.05	.05	.05	.05	.05
1775.00	.05	.05	.05	.05	.05	.05
1780.00	.05	.05	.05	.05	.05	.05
1785.00	.05	.05	.05	.05	.05	.05
1790.00	.05	.05	.05	.05	.05	.05
1795.00	.05	.05	.05	.05	.05	.05
1800.00	.05	.05	.05	.05	.05	.05
1805.00	.05	.05	.05	.05	.05	.05
1810.00	.05	.05	.05	.05	.05	.05
1815.00	.05	.05	.05	.05	.04	.04
1820.00	.04	.04	.04	.04	.04	.04
1825.00	.04	.04	.04	.04	.04	.04
1830.00	.04	.04	.04	.04	.04	.04
1835.00	.04	.04	.04	.04	.04	.04
1840.00	.04	.04	.04	.04	.04	.04
1845.00	.04	.04	.04	.04	.04	.04
1850.00	.04	.04	.04	.04	.04	.04
1855.00	.04	.04	.04	.04	.04	.04
1860.00	.04	.04	.04	.04	.04	.04
1865.00	.04	.04	.04	.04	.04	.04
1870.00	.04	.04	.04	.04	.04	.04
1875.00	.04	.04	.04	.04	.04	.04
1880.00	.04	.04	.04	.04	.04	.04
1885.00	.04	.04	.04	.04	.04	.04
1890.00	.04	.04	.04	.04	.04	.04
1895.00	.04	.04	.04	.04	.04	.04
1900.00	.04	.04	.04	.04	.04	.04
1905.00	.04	.04	.04	.04	.04	.04

Type.... Pond Routed HYG (total out)
 Name.... BASIN B OUT Tag: B 25yr
 File.... C:\MY DOCUMENTS\AVONDALE HEIGHTS DETENTION.PPW
 Storm... B 25yr Tag: B 25yr

Page 4.22
 Event: B 25yr

WARNING: Hydrograph truncated on right side.

HYDROGRAPH ORDINATES (cfs)						
Time min	Output Time increment = 1.00 min					
	Time on left represents time for first value in each row.					
1910.00	.04	.04	.04	.04	.04	.04
1915.00	.04	.04	.04	.04	.04	.04
1920.00	.04	.04	.04	.04	.04	.04
1925.00	.04	.04	.04	.04	.04	.04
1930.00	.04	.04	.04	.04	.04	.04
1935.00	.04	.04	.04	.04	.04	.04
1940.00	.04	.04	.04	.04	.04	.04
1945.00	.04	.04	.04	.04	.04	.04
1950.00	.04	.04	.04	.04	.04	.04
1955.00	.04	.04	.04	.04	.04	.04
1960.00	.04	.04	.04	.04	.04	.04
1965.00	.04	.04	.04	.04	.04	.04
1970.00	.04	.04	.04	.04	.04	.04
1975.00	.04	.04	.04	.04	.04	.04
1980.00	.04	.04	.04	.04	.04	.04
1985.00	.04	.04	.04	.04	.04	.04
1990.00	.04	.04	.04	.04	.04	.04
1995.00	.04	.04	.04	.04	.04	.04
2000.00	.04					

Type.... Pond Routing Summary
Name.... BASIN B OUT Tag: C 100y
File.... C:\MY DOCUMENTS\AVONDALE HEIGHTS DETENTION.PPW
Storm... C 100yr Tag: C 100y

Page 4.23
Event: C 100yr

LEVEL POOL ROUTING SUMMARY

HYG Dir = C:\MY DOCUMENTS\
Inflow HYG file = NONE STORED - BASIN B IN C 100y
Outflow HYG file = NONE STORED - BASIN B OUT C 100y

Pond Node Data = BASIN B
Pond Volume Data = BASIN B
Pond Outlet Data = OVERFLOW 44

No Infiltration

INITIAL CONDITIONS

Starting WS Elev = 498.00 ft
Starting Volume = 0 cu.ft
Starting Outflow = .00 cfs
Starting Infiltr. = .00 cfs
Starting Total Qout = .00 cfs
Time Increment = 1.00 min

INFLOW/OUTFLOW HYDROGRAPH SUMMARY

=====
Peak Inflow = 63.05 cfs at 5.00 min
Peak Outflow = 15.71 cfs at 24.00 min

Peak Elevation = 499.74 ft
Peak Storage = 69038 cu.ft
=====

MASS BALANCE (cu.ft)

+ Initial Vol = 0
+ HYG Vol IN = 75660
- Infiltration = 0
- HYG Vol OUT = 73395
- Retained Vol = 2263

Unrouted Vol = -2 cu.ft (.003% of Inflow Volume)

WARNING: Outflow hydrograph truncated on right side.

Type... Pond Routed HYG (total out)
 Name... BASIN B OUT Tag: C 100y
 File... C:\MY DOCUMENTS\AVONDALE HEIGHTS DETENTION.PPW
 Storm... C 100yr Tag: C 100y

POND ROUTED TOTAL OUTFLOW HYG...

HYG file =
 HYG ID = BASIN B OUT
 HYG Tag = C 100y

 Peak Discharge = 15.71 cfs
 Time to Peak = 24.00 min
 HYG Volume = 73395 cu.ft

WARNING: Hydrograph truncated on right side.

HYDROGRAPH ORDINATES (cfs)
 Output Time increment = 1.00 min
 Time on left represents time for first value in each row.

Time min					
.00	.00	.01	.03	.06	.13
5.00	.25	.41	.60	.80	1.02
10.00	1.26	1.51	1.77	2.04	2.32
15.00	2.61	3.71	5.35	7.31	9.41
20.00	11.59	13.54	14.86	15.57	15.71
25.00	15.31	14.66	14.03	13.42	12.84
30.00	12.28	11.75	11.26	10.80	10.37
35.00	9.95	9.55	9.16	8.79	8.46
40.00	8.15	7.85	7.57	7.29	7.02
45.00	6.77	6.52	6.28	6.06	5.88
50.00	5.70	5.53	5.36	5.20	5.04
55.00	4.89	4.74	4.60	4.46	4.32
60.00	4.19	4.06	3.96	3.88	3.81
65.00	3.73	3.66	3.58	3.51	3.44
70.00	3.37	3.31	3.24	3.18	3.11
75.00	3.05	2.99	2.93	2.87	2.82
80.00	2.76	2.71	2.65	2.63	2.62
85.00	2.61	2.59	2.58	2.57	2.56
90.00	2.55	2.53	2.52	2.51	2.50
95.00	2.48	2.47	2.46	2.45	2.44
100.00	2.43	2.41	2.40	2.39	2.38
105.00	2.37	2.36	2.35	2.33	2.32
110.00	2.31	2.30	2.29	2.28	2.27
115.00	2.26	2.25	2.24	2.23	2.22
120.00	2.21	2.20	2.19	2.18	2.17
125.00	2.16	2.15	2.14	2.13	2.12
130.00	2.11	2.10	2.09	2.08	2.07
135.00	2.06	2.05	2.04	2.03	2.02
140.00	2.01	2.00	2.00	1.99	1.98
145.00	1.97	1.96	1.95	1.94	1.93

Type.... Pond Routed HYG (total out)
 Name.... BASIN B OUT Tag: C 100y
 File.... C:\MY DOCUMENTS\AVONDALE HEIGHTS DETENTION.PPW
 Storm... C 100yr Tag: C 100y

Page 4.25
 Event: C 100yr

WARNING: Hydrograph truncated on right side.

HYDROGRAPH ORDINATES (cfs)						
Time min	Output Time increment = 1.00 min					
	Time on left represents time for first value in each row.					
150.00	1.93	1.92	1.91	1.90	1.89	
155.00	1.88	1.88	1.87	1.86	1.85	
160.00	1.84	1.83	1.83	1.82	1.81	
165.00	1.80	1.79	1.79	1.78	1.77	
170.00	1.76	1.76	1.75	1.74	1.73	
175.00	1.72	1.72	1.71	1.70	1.70	
180.00	1.69	1.68	1.67	1.67	1.66	
185.00	1.65	1.65	1.64	1.63	1.63	
190.00	1.62	1.61	1.61	1.60	1.59	
195.00	1.59	1.58	1.57	1.57	1.56	
200.00	1.55	1.55	1.54	1.53	1.53	
205.00	1.52	1.51	1.51	1.50	1.49	
210.00	1.49	1.48	1.48	1.47	1.46	
215.00	1.46	1.45	1.45	1.44	1.43	
220.00	1.43	1.42	1.42	1.41	1.41	
225.00	1.40	1.39	1.39	1.38	1.38	
230.00	1.37	1.37	1.36	1.36	1.35	
235.00	1.35	1.34	1.33	1.33	1.32	
240.00	1.32	1.31	1.31	1.30	1.30	
245.00	1.29	1.29	1.28	1.28	1.27	
250.00	1.27	1.26	1.26	1.25	1.25	
255.00	1.24	1.24	1.23	1.23	1.22	
260.00	1.22	1.21	1.21	1.20	1.20	
265.00	1.19	1.19	1.18	1.18	1.18	
270.00	1.17	1.17	1.16	1.16	1.15	
275.00	1.15	1.15	1.14	1.14	1.13	
280.00	1.13	1.12	1.12	1.12	1.11	
285.00	1.11	1.10	1.10	1.10	1.09	
290.00	1.09	1.08	1.08	1.08	1.07	
295.00	1.07	1.06	1.06	1.06	1.05	
300.00	1.05	1.04	1.04	1.04	1.03	
305.00	1.03	1.02	1.02	1.02	1.01	
310.00	1.01	1.01	1.00	1.00	.99	
315.00	.99	.99	.98	.98	.98	
320.00	.97	.97	.97	.96	.96	
325.00	.95	.95	.95	.94	.94	
330.00	.94	.93	.93	.93	.92	
335.00	.92	.92	.91	.91	.91	
340.00	.90	.90	.90	.90	.89	
345.00	.89	.89	.88	.88	.88	
350.00	.87	.87	.87	.87	.86	
355.00	.86	.86	.85	.85	.85	
360.00	.84	.84	.84	.84	.83	
365.00	.83	.83	.82	.82	.82	

Type.... Pond Routed HYG (total out)
 Name.... BASIN B OUT Tag: C 100y
 File.... C:\MY DOCUMENTS\AVONDALE HEIGHTS DETENTION.PPW
 Storm... C 100yr Tag: C 100y

Page 4.26
 Event: C 100yr

WARNING: Hydrograph truncated on right side.

HYDROGRAPH ORDINATES (cfs)						
Time min	Output Time increment = 1.00 min					
	Time on left represents time for first value in each row.					
370.00	.82	.81	.81	.81	.80	.80
375.00	.80	.80	.80	.79	.79	.79
380.00	.79	.79	.78	.78	.78	.78
385.00	.77	.77	.77	.77	.76	.76
390.00	.76	.76	.76	.75	.75	.75
395.00	.75	.75	.74	.74	.74	.74
400.00	.74	.73	.73	.73	.73	.73
405.00	.72	.72	.72	.72	.71	.71
410.00	.71	.71	.71	.70	.70	.70
415.00	.70	.70	.70	.69	.69	.69
420.00	.69	.69	.68	.68	.68	.68
425.00	.68	.68	.67	.67	.67	.67
430.00	.67	.67	.66	.66	.66	.66
435.00	.66	.66	.65	.65	.65	.65
440.00	.65	.65	.64	.64	.64	.64
445.00	.64	.64	.63	.63	.63	.63
450.00	.63	.63	.62	.62	.62	.62
455.00	.62	.62	.61	.61	.61	.61
460.00	.61	.61	.60	.60	.60	.60
465.00	.60	.60	.59	.59	.59	.59
470.00	.59	.59	.59	.58	.58	.58
475.00	.58	.58	.58	.57	.57	.57
480.00	.57	.57	.57	.57	.56	.56
485.00	.56	.56	.56	.56	.55	.55
490.00	.55	.55	.55	.55	.55	.55
495.00	.54	.54	.54	.54	.54	.54
500.00	.54	.53	.53	.53	.53	.53
505.00	.53	.53	.52	.52	.52	.52
510.00	.52	.52	.52	.51	.51	.51
515.00	.51	.51	.51	.51	.51	.51
520.00	.50	.50	.50	.50	.50	.50
525.00	.50	.50	.49	.49	.49	.49
530.00	.49	.49	.49	.49	.48	.48
535.00	.48	.48	.48	.48	.48	.48
540.00	.48	.48	.47	.47	.47	.47
545.00	.47	.47	.47	.47	.47	.47
550.00	.46	.46	.46	.46	.46	.46
555.00	.46	.46	.45	.45	.45	.45
560.00	.45	.45	.45	.45	.45	.45
565.00	.44	.44	.44	.44	.44	.44
570.00	.44	.44	.44	.44	.43	.43
575.00	.43	.43	.43	.43	.43	.43
580.00	.43	.43	.42	.42	.42	.42
585.00	.42	.42	.42	.42	.42	.42

S/N: f21101d06a84 Bax Engineering Compute Time: 13:01:23 Date: 08-12-2002
 PondPack Ver: 7.0 (325)

Type.... Pond Routed HYG (total out)
 Name.... BASIN B OUT Tag: C 100y
 File.... C:\MY DOCUMENTS\AVONDALE HEIGHTS DETENTION.PPW
 Storm... C 100yr Tag: C 100y

WARNING: Hydrograph truncated on right side.

HYDROGRAPH ORDINATES (cfs)						
Time min	Output Time increment = 1.00 min					
	Time on left represents time for first value in each row.					
590.00	.41	.41	.41	.41	.41	.41
595.00	.41	.41	.41	.41	.41	.40
600.00	.40	.40	.40	.40	.40	.40
605.00	.40	.40	.40	.39	.39	.39
610.00	.39	.39	.39	.39	.39	.39
615.00	.39	.39	.38	.38	.38	.38
620.00	.38	.38	.38	.38	.38	.38
625.00	.38	.38	.37	.37	.37	.37
630.00	.37	.37	.37	.37	.37	.37
635.00	.37	.37	.36	.36	.36	.36
640.00	.36	.36	.36	.36	.36	.36
645.00	.36	.36	.35	.35	.35	.35
650.00	.35	.35	.35	.35	.35	.35
655.00	.35	.35	.34	.34	.34	.34
660.00	.34	.34	.34	.34	.34	.34
665.00	.34	.34	.33	.33	.33	.33
670.00	.33	.33	.33	.33	.33	.33
675.00	.33	.33	.33	.33	.33	.32
680.00	.32	.32	.32	.32	.32	.32
685.00	.32	.32	.32	.32	.32	.32
690.00	.32	.32	.32	.32	.31	.31
695.00	.31	.31	.31	.31	.31	.31
700.00	.31	.31	.31	.31	.31	.31
705.00	.31	.30	.30	.30	.30	.30
710.00	.30	.30	.30	.30	.30	.30
715.00	.30	.30	.30	.30	.30	.30
720.00	.29	.29	.29	.29	.29	.29
725.00	.29	.29	.29	.29	.29	.29
730.00	.29	.29	.29	.29	.29	.29
735.00	.28	.28	.28	.28	.28	.28
740.00	.28	.28	.28	.28	.28	.28
745.00	.28	.28	.28	.28	.28	.28
750.00	.27	.27	.27	.27	.27	.27
755.00	.27	.27	.27	.27	.27	.27
760.00	.27	.27	.27	.27	.27	.27
765.00	.27	.26	.26	.26	.26	.26
770.00	.26	.26	.26	.26	.26	.26
775.00	.26	.26	.26	.26	.26	.26
780.00	.26	.26	.25	.25	.25	.25
785.00	.25	.25	.25	.25	.25	.25
790.00	.25	.25	.25	.25	.25	.25
795.00	.25	.25	.25	.25	.25	.24
800.00	.24	.24	.24	.24	.24	.24
805.00	.24	.24	.24	.24	.24	.24

Type... Pond Routed HYG (total out)
 Name... BASIN B OUT Tag: C 100y
 File... C:\MY DOCUMENTS\AVONDALE HEIGHTS DETENTION.PPW
 Storm... C 100yr Tag: C 100y

Page 4.28
 Event: C 100yr

WARNING: Hydrograph truncated on right side.

HYDROGRAPH ORDINATES (cfs)						
Time min	Output Time increment = 1.00 min					
	Time on left represents time for first value in each row.					
810.00	.24	.24	.24	.24	.24	.24
815.00	.24	.24	.23	.23	.23	.23
820.00	.23	.23	.23	.23	.23	.23
825.00	.23	.23	.23	.23	.23	.23
830.00	.23	.23	.23	.23	.23	.23
835.00	.22	.22	.22	.22	.22	.22
840.00	.22	.22	.22	.22	.22	.22
845.00	.22	.22	.22	.22	.22	.22
850.00	.22	.22	.22	.22	.22	.21
855.00	.21	.21	.21	.21	.21	.21
860.00	.21	.21	.21	.21	.21	.21
865.00	.21	.21	.21	.21	.21	.21
870.00	.21	.21	.21	.21	.21	.20
875.00	.20	.20	.20	.20	.20	.20
880.00	.20	.20	.20	.20	.20	.20
885.00	.20	.20	.20	.20	.20	.20
890.00	.20	.20	.20	.20	.20	.20
895.00	.20	.19	.19	.19	.19	.19
900.00	.19	.19	.19	.19	.19	.19
905.00	.19	.19	.19	.19	.19	.19
910.00	.19	.19	.19	.19	.19	.19
915.00	.19	.19	.19	.19	.18	.18
920.00	.18	.18	.18	.18	.18	.18
925.00	.18	.18	.18	.18	.18	.18
930.00	.18	.18	.18	.18	.18	.18
935.00	.18	.18	.18	.18	.18	.18
940.00	.18	.18	.18	.18	.18	.18
945.00	.17	.17	.17	.17	.17	.17
950.00	.17	.17	.17	.17	.17	.17
955.00	.17	.17	.17	.17	.17	.17
960.00	.17	.17	.17	.17	.17	.17
965.00	.17	.17	.17	.17	.17	.17
970.00	.17	.17	.17	.17	.17	.17
975.00	.17	.17	.16	.16	.16	.16
980.00	.16	.16	.16	.16	.16	.16
985.00	.16	.16	.16	.16	.16	.16
990.00	.16	.16	.16	.16	.16	.16
995.00	.16	.16	.16	.16	.16	.16
1000.00	.16	.16	.16	.16	.16	.16
1005.00	.16	.16	.16	.16	.16	.16
1010.00	.16	.15	.15	.15	.15	.15
1015.00	.15	.15	.15	.15	.15	.15
1020.00	.15	.15	.15	.15	.15	.15
1025.00	.15	.15	.15	.15	.15	.15

S/N: f21101d06a84 Bax Engineering
 PondPack Ver: 7.0 (325) Compute Time: 13:01:23 Date: 08-12-2002

Type.... Pond Routed HYG (total out)
 Name.... BASIN B OUT Tag: C 100y
 File.... C:\MY DOCUMENTS\AVONDALE HEIGHTS DETENTION.PPW
 Storm... C 100yr Tag: C 100y

WARNING: Hydrograph truncated on right side.

Time min	HYDROGRAPH ORDINATES (cfs)				
	Output Time increment = 1.00 min				
Time on left represents time for first value in each row.					
1030.00	.15	.15	.15	.15	.15
1035.00	.15	.15	.15	.15	.15
1040.00	.15	.15	.15	.15	.15
1045.00	.15	.15	.14	.14	.14
1050.00	.14	.14	.14	.14	.14
1055.00	.14	.14	.14	.14	.14
1060.00	.14	.14	.14	.14	.14
1065.00	.14	.14	.14	.14	.14
1070.00	.14	.14	.14	.14	.14
1075.00	.14	.14	.14	.14	.14
1080.00	.14	.14	.14	.14	.14
1085.00	.14	.13	.13	.13	.13
1090.00	.13	.13	.13	.13	.13
1095.00	.13	.13	.13	.13	.13
1100.00	.13	.13	.13	.13	.13
1105.00	.13	.13	.13	.13	.13
1110.00	.13	.13	.13	.13	.13
1115.00	.13	.13	.13	.13	.13
1120.00	.13	.13	.13	.13	.13
1125.00	.13	.13	.13	.12	.12
1130.00	.12	.12	.12	.12	.12
1135.00	.12	.12	.12	.12	.12
1140.00	.12	.12	.12	.12	.12
1145.00	.12	.12	.12	.12	.12
1150.00	.12	.12	.12	.12	.12
1155.00	.12	.12	.12	.12	.12
1160.00	.12	.12	.12	.12	.12
1165.00	.12	.12	.12	.12	.12
1170.00	.12	.12	.12	.11	.11
1175.00	.11	.11	.11	.11	.11
1180.00	.11	.11	.11	.11	.11
1185.00	.11	.11	.11	.11	.11
1190.00	.11	.11	.11	.11	.11
1195.00	.11	.11	.11	.11	.11
1200.00	.11	.11	.11	.11	.11
1205.00	.11	.11	.11	.11	.11
1210.00	.11	.11	.11	.11	.11
1215.00	.11	.11	.11	.11	.11
1220.00	.11	.11	.11	.10	.10
1225.00	.10	.10	.10	.10	.10
1230.00	.10	.10	.10	.10	.10
1235.00	.10	.10	.10	.10	.10
1240.00	.10	.10	.10	.10	.10
1245.00	.10	.10	.10	.10	.10

Type.... Pond Routed HYG (total out)
 Name.... BASIN B OUT Tag: C 100y
 File.... C:\MY DOCUMENTS\AVONDALE HEIGHTS DETENTION.PPW
 Storm... C 100yr Tag: C 100y

WARNING: Hydrograph truncated on right side.

HYDROGRAPH ORDINATES (cfs)						
Time min	Output Time increment = 1.00 min					
	Time on left represents time for first value in each row.					
1250.00	.10	.10	.10	.10	.10	.10
1255.00	.10	.10	.10	.10	.10	.10
1260.00	.10	.10	.10	.10	.10	.10
1265.00	.10	.10	.10	.10	.10	.10
1270.00	.10	.10	.10	.10	.10	.10
1275.00	.10	.10	.09	.09	.09	.09
1280.00	.09	.09	.09	.09	.09	.09
1285.00	.09	.09	.09	.09	.09	.09
1290.00	.09	.09	.09	.09	.09	.09
1295.00	.09	.09	.09	.09	.09	.09
1300.00	.09	.09	.09	.09	.09	.09
1305.00	.09	.09	.09	.09	.09	.09
1310.00	.09	.09	.09	.09	.09	.09
1315.00	.09	.09	.09	.09	.09	.09
1320.00	.09	.09	.09	.09	.09	.09
1325.00	.09	.09	.09	.09	.09	.09
1330.00	.09	.09	.09	.09	.09	.09
1335.00	.09	.09	.09	.08	.08	.08
1340.00	.08	.08	.08	.08	.08	.08
1345.00	.08	.08	.08	.08	.08	.08
1350.00	.08	.08	.08	.08	.08	.08
1355.00	.08	.08	.08	.08	.08	.08
1360.00	.08	.08	.08	.08	.08	.08
1365.00	.08	.08	.08	.08	.08	.08
1370.00	.08	.08	.08	.08	.08	.08
1375.00	.08	.08	.08	.08	.08	.08
1380.00	.08	.08	.08	.08	.08	.08
1385.00	.08	.08	.08	.08	.08	.08
1390.00	.08	.08	.08	.08	.08	.08
1395.00	.08	.08	.08	.08	.08	.08
1400.00	.08	.08	.08	.08	.08	.08
1405.00	.08	.07	.07	.07	.07	.07
1410.00	.07	.07	.07	.07	.07	.07
1415.00	.07	.07	.07	.07	.07	.07
1420.00	.07	.07	.07	.07	.07	.07
1425.00	.07	.07	.07	.07	.07	.07
1430.00	.07	.07	.07	.07	.07	.07
1435.00	.07	.07	.07	.07	.07	.07
1440.00	.07	.07	.07	.07	.07	.07
1445.00	.07	.07	.07	.07	.07	.07
1450.00	.07	.07	.07	.07	.07	.07
1455.00	.07	.07	.07	.07	.07	.07
1460.00	.07	.07	.07	.07	.07	.07
1465.00	.07	.07	.07	.07	.07	.07

Type.... Pond Routed HYG (total out)
 Name.... BASIN B OUT Tag: C 100y
 File.... C:\MY DOCUMENTS\AVONDALE HEIGHTS DETENTION.PPW
 Storm... C 100yr Tag: C 100y

WARNING: Hydrograph truncated on right side.

HYDROGRAPH ORDINATES (cfs)						
Time min	Output Time increment = 1.00 min					
	Time on left represents time for first value in each row.					
1470.00	.07	.07	.07	.07	.07	.07
1475.00	.07	.07	.07	.07	.07	.07
1480.00	.07	.07	.07	.07	.07	.06
1485.00	.06	.06	.06	.06	.06	.06
1490.00	.06	.06	.06	.06	.06	.06
1495.00	.06	.06	.06	.06	.06	.06
1500.00	.06	.06	.06	.06	.06	.06
1505.00	.06	.06	.06	.06	.06	.06
1510.00	.06	.06	.06	.06	.06	.06
1515.00	.06	.06	.06	.06	.06	.06
1520.00	.06	.06	.06	.06	.06	.06
1525.00	.06	.06	.06	.06	.06	.06
1530.00	.06	.06	.06	.06	.06	.06
1535.00	.06	.06	.06	.06	.06	.06
1540.00	.06	.06	.06	.06	.06	.06
1545.00	.06	.06	.06	.06	.06	.06
1550.00	.06	.06	.06	.06	.06	.06
1555.00	.06	.06	.06	.06	.06	.06
1560.00	.06	.06	.06	.06	.06	.06
1565.00	.06	.06	.06	.06	.06	.06
1570.00	.06	.06	.06	.06	.06	.06
1575.00	.06	.06	.06	.06	.06	.06
1580.00	.06	.06	.06	.06	.06	.06
1585.00	.06	.06	.06	.06	.06	.06
1590.00	.06	.06	.06	.06	.06	.06
1595.00	.06	.06	.06	.06	.06	.06
1600.00	.06	.06	.06	.06	.06	.06
1605.00	.06	.06	.06	.06	.06	.06
1610.00	.06	.06	.06	.06	.06	.06
1615.00	.06	.06	.06	.06	.06	.06
1620.00	.06	.06	.06	.06	.06	.06
1625.00	.06	.06	.06	.06	.06	.06
1630.00	.06	.06	.06	.06	.06	.06
1635.00	.06	.06	.06	.06	.06	.05
1640.00	.05	.05	.05	.05	.05	.05
1645.00	.05	.05	.05	.05	.05	.05
1650.00	.05	.05	.05	.05	.05	.05
1655.00	.05	.05	.05	.05	.05	.05
1660.00	.05	.05	.05	.05	.05	.05
1665.00	.05	.05	.05	.05	.05	.05
1670.00	.05	.05	.05	.05	.05	.05
1675.00	.05	.05	.05	.05	.05	.05
1680.00	.05	.05	.05	.05	.05	.05
1685.00	.05	.05	.05	.05	.05	.05

Type.... Pond Routed HYG (total out)
 Name.... BASIN B OUT Tag: C 100y
 File.... C:\MY DOCUMENTS\AVONDALE HEIGHTS DETENTION.PPW
 Storm... C 100yr Tag: C 100y

WARNING: Hydrograph truncated on right side.

HYDROGRAPH ORDINATES (cfs)						
Time min	Output Time increment = 1.00 min					
	Time on left represents time for first value in each row.					
1690.00	.05	.05	.05	.05	.05	.05
1695.00	.05	.05	.05	.05	.05	.05
1700.00	.05	.05	.05	.05	.05	.05
1705.00	.05	.05	.05	.05	.05	.05
1710.00	.05	.05	.05	.05	.05	.05
1715.00	.05	.05	.05	.05	.05	.05
1720.00	.05	.05	.05	.05	.05	.05
1725.00	.05	.05	.05	.05	.05	.05
1730.00	.05	.05	.05	.05	.05	.05
1735.00	.05	.05	.05	.05	.05	.05
1740.00	.05	.05	.05	.05	.05	.05
1745.00	.05	.05	.05	.05	.05	.05
1750.00	.05	.05	.05	.05	.05	.05
1755.00	.05	.05	.05	.05	.05	.05
1760.00	.05	.05	.05	.05	.05	.05
1765.00	.05	.05	.05	.05	.05	.05
1770.00	.05	.05	.05	.05	.05	.05
1775.00	.05	.05	.05	.05	.05	.05
1780.00	.05	.05	.05	.05	.05	.05
1785.00	.05	.05	.05	.05	.05	.05
1790.00	.05	.05	.05	.05	.05	.05
1795.00	.05	.05	.05	.05	.05	.05
1800.00	.05	.05	.05	.05	.05	.05
1805.00	.05	.05	.05	.05	.05	.05
1810.00	.05	.05	.05	.05	.05	.05
1815.00	.05	.05	.05	.05	.05	.05
1820.00	.05	.05	.05	.05	.05	.05
1825.00	.05	.05	.05	.05	.05	.05
1830.00	.05	.05	.05	.05	.05	.05
1835.00	.05	.05	.05	.05	.04	.04
1840.00	.04	.04	.04	.04	.04	.04
1845.00	.04	.04	.04	.04	.04	.04
1850.00	.04	.04	.04	.04	.04	.04
1855.00	.04	.04	.04	.04	.04	.04
1860.00	.04	.04	.04	.04	.04	.04
1865.00	.04	.04	.04	.04	.04	.04
1870.00	.04	.04	.04	.04	.04	.04
1875.00	.04	.04	.04	.04	.04	.04
1880.00	.04	.04	.04	.04	.04	.04
1885.00	.04	.04	.04	.04	.04	.04
1890.00	.04	.04	.04	.04	.04	.04
1895.00	.04	.04	.04	.04	.04	.04
1900.00	.04	.04	.04	.04	.04	.04
1905.00	.04	.04	.04	.04	.04	.04

Type.... Pond Routed HYG (total out)
 Name.... BASIN B OUT Tag: C 100y
 File.... C:\MY DOCUMENTS\AVONDALE HEIGHTS DETENTION.PPW
 Storm... C 100yr Tag: C 100y

WARNING: Hydrograph truncated on right side.

Time min	HYDROGRAPH ORDINATES (cfs)				
	Output Time increment = 1.00 min				
Time on left represents time for first value in each row.					
1910.00	.04	.04	.04	.04	.04
1915.00	.04	.04	.04	.04	.04
1920.00	.04	.04	.04	.04	.04
1925.00	.04	.04	.04	.04	.04
1930.00	.04	.04	.04	.04	.04
1935.00	.04	.04	.04	.04	.04
1940.00	.04	.04	.04	.04	.04
1945.00	.04	.04	.04	.04	.04
1950.00	.04	.04	.04	.04	.04
1955.00	.04	.04	.04	.04	.04
1960.00	.04	.04	.04	.04	.04
1965.00	.04	.04	.04	.04	.04
1970.00	.04	.04	.04	.04	.04
1975.00	.04	.04	.04	.04	.04
1980.00	.04	.04	.04	.04	.04
1985.00	.04	.04	.04	.04	.04
1990.00	.04	.04	.04	.04	.04
1995.00	.04	.04	.04	.04	.04
2000.00	.04				

Index of Starting Page Numbers for ID Names

----- 2 -----

20 MINUTE INFLOW A 15yr... 1.01,
1.05, 1.09

----- B -----

BASIN B... 2.01, 4.01, 4.02, 4.12,
4.13, 4.23, 4.24

----- 0 -----

OVERFLOW 44... 3.01, 3.04

POND 7
Routing Calculations for
100 Year 20 Minute Design Storm
With Low Flow 100% Blocked

Avondale Heights

Table of Contents

***** RUNOFF HYDROGRAPHS *****

20 MINUTE INFLOW C 100y	
Read HYG	1.01

***** OUTLET STRUCTURES *****

OS 44 BLOCKED... Outlet Input Data	2.01
Composite Rating Curve	2.04

***** POND ROUTING *****

BASIN B	OUT C 100y	
	Pond Routing Summary	3.01
	Pond Routed HYG (total out)	3.02

Type.... Read HYG
 Name.... 20 MINUTE INFLOW
 File.... C:\MY DOCUMENTS\AVONDALE HEIGHTS DETENTION.PPW
 Storm... Tag: C 100y

HYG file = C:\MY DOCUMENTS\AVON 100.HYG
 HYG ID = Avondale100yr in
 HYG Tag = 100yr

 Peak Discharge = 63.05 cfs
 Time to Peak = 5.00 min
 HYG Volume = 75660 cu.ft

HYDROGRAPH ORDINATES (cfs)
 Output Time increment = 1.00 min
 Time on left represents time for first value in each row.

Time min					
.00	.00	12.61	25.22	37.83	50.44
5.00	63.05	63.05	63.05	63.05	63.05
10.00	63.05	63.05	63.05	63.05	63.05
15.00	63.05	63.05	63.05	63.05	63.05
20.00	63.05	50.44	37.83	25.22	12.61
25.00	.00	.00	.00	.00	.00
30.00	.00	.00	.00	.00	.00
35.00	.00	.00	.00	.00	.00
40.00	.00	.00	.00	.00	.00
45.00	.00	.00	.00	.00	.00
50.00	.00	.00	.00	.00	.00
55.00	.00	.00	.00	.00	.00
60.00	.00	.00	.00	.00	.00
65.00	.00	.00	.00	.00	.00
70.00	.00	.00	.00	.00	.00
75.00	.00	.00	.00	.00	.00
80.00	.00	.00	.00	.00	.00
85.00	.00	.00	.00	.00	.00
90.00	.00	.00	.00	.00	.00
95.00	.00	.00	.00	.00	.00
100.00	.00	.00	.00	.00	.00
105.00	.00	.00	.00	.00	.00
110.00	.00	.00	.00	.00	.00
115.00	.00	.00	.00	.00	.00
120.00	.00	.00	.00	.00	.00
125.00	.00	.00	.00	.00	.00
130.00	.00	.00	.00	.00	.00
135.00	.00	.00	.00	.00	.00
140.00	.00	.00	.00	.00	.00
145.00	.00	.00	.00	.00	.00
150.00	.00	.00	.00	.00	.00
155.00	.00	.00	.00	.00	.00
160.00	.00	.00	.00	.00	.00

Type.... Read HYG
 Name.... 20 MINUTE INFLOW
 File.... C:\MY DOCUMENTS\AVONDALE HEIGHTS DETENTION.PPW
 Storm... Tag: C 100y

HYDROGRAPH ORDINATES (cfs)
 Output Time increment = 1.00 min
 Time on left represents time for first value in each row.

Time min					
165.00	.00	.00	.00	.00	.00
170.00	.00	.00	.00	.00	.00
175.00	.00	.00	.00	.00	.00
180.00	.00	.00	.00	.00	.00
185.00	.00	.00	.00	.00	.00
190.00	.00	.00	.00	.00	.00
195.00	.00	.00	.00	.00	.00
200.00	.00	.00	.00	.00	.00
205.00	.00	.00	.00	.00	.00
210.00	.00	.00	.00	.00	.00
215.00	.00	.00	.00	.00	.00
220.00	.00	.00	.00	.00	.00
225.00	.00	.00	.00	.00	.00
230.00	.00	.00	.00	.00	.00
235.00	.00	.00	.00	.00	.00
240.00	.00	.00	.00	.00	.00
245.00	.00	.00	.00	.00	.00
250.00	.00	.00	.00	.00	.00
255.00	.00	.00	.00	.00	.00
260.00	.00	.00	.00	.00	.00
265.00	.00	.00	.00	.00	.00
270.00	.00	.00	.00	.00	.00
275.00	.00	.00	.00	.00	.00
280.00	.00	.00	.00	.00	.00
285.00	.00	.00	.00	.00	.00
290.00	.00	.00	.00	.00	.00
295.00	.00	.00	.00	.00	.00
300.00	.00	.00	.00	.00	.00
305.00	.00	.00	.00	.00	.00
310.00	.00	.00	.00	.00	.00
315.00	.00	.00	.00	.00	.00
320.00	.00	.00	.00	.00	.00
325.00	.00	.00	.00	.00	.00
330.00	.00	.00	.00	.00	.00
335.00	.00	.00	.00	.00	.00
340.00	.00	.00	.00	.00	.00
345.00	.00	.00	.00	.00	.00
350.00	.00	.00	.00	.00	.00
355.00	.00	.00	.00	.00	.00
360.00	.00	.00	.00	.00	.00
365.00	.00	.00	.00	.00	.00
370.00	.00	.00	.00	.00	.00
375.00	.00	.00	.00	.00	.00
380.00	.00	.00	.00	.00	.00
385.00	.00	.00	.00	.00	.00
390.00	.00	.00	.00	.00	.00
395.00	.00	.00	.00	.00	.00

Type... Read HYG
 Name... 20 MINUTE INFLOW
 File... C:\MY DOCUMENTS\AVONDALE HEIGHTS DETENTION.PPW
 Storm... Tag: C 100y

HYDROGRAPH ORDINATES (cfs)
 Output Time increment = 1.00 min
 Time on left represents time for first value in each row.

Time min					
400.00	.00	.00	.00	.00	.00
405.00	.00	.00	.00	.00	.00
410.00	.00	.00	.00	.00	.00
415.00	.00	.00	.00	.00	.00
420.00	.00	.00	.00	.00	.00
425.00	.00	.00	.00	.00	.00
430.00	.00	.00	.00	.00	.00
435.00	.00	.00	.00	.00	.00
440.00	.00	.00	.00	.00	.00
445.00	.00	.00	.00	.00	.00
450.00	.00	.00	.00	.00	.00
455.00	.00	.00	.00	.00	.00
460.00	.00	.00	.00	.00	.00
465.00	.00	.00	.00	.00	.00
470.00	.00	.00	.00	.00	.00
475.00	.00	.00	.00	.00	.00
480.00	.00	.00	.00	.00	.00
485.00	.00	.00	.00	.00	.00
490.00	.00	.00	.00	.00	.00
495.00	.00	.00	.00	.00	.00
500.00	.00	.00	.00	.00	.00
505.00	.00	.00	.00	.00	.00
510.00	.00	.00	.00	.00	.00
515.00	.00	.00	.00	.00	.00
520.00	.00	.00	.00	.00	.00
525.00	.00	.00	.00	.00	.00
530.00	.00	.00	.00	.00	.00
535.00	.00	.00	.00	.00	.00
540.00	.00	.00	.00	.00	.00
545.00	.00	.00	.00	.00	.00
550.00	.00	.00	.00	.00	.00
555.00	.00	.00	.00	.00	.00
560.00	.00	.00	.00	.00	.00
565.00	.00	.00	.00	.00	.00
570.00	.00	.00	.00	.00	.00
575.00	.00	.00	.00	.00	.00
580.00	.00	.00	.00	.00	.00
585.00	.00	.00	.00	.00	.00
590.00	.00	.00	.00	.00	.00
595.00	.00	.00	.00	.00	.00
600.00	.00	.00	.00	.00	.00
605.00	.00	.00	.00	.00	.00
610.00	.00	.00	.00	.00	.00
615.00	.00	.00	.00	.00	.00
620.00	.00	.00	.00	.00	.00
625.00	.00	.00	.00	.00	.00
630.00	.00	.00	.00	.00	.00

Type... Read HYG

Name... 20 MINUTE INFLOW

Event: C 100yr

File... C:\MY DOCUMENTS\AVONDALE HEIGHTS DETENTION.PPW

Storm... Tag: C 100y

HYDROGRAPH ORDINATES (cfs)
Output Time increment = 1.00 min
Time on left represents time for first value in each row.

Time min					
635.00	.00	.00	.00	.00	.00
640.00	.00	.00	.00	.00	.00
645.00	.00	.00	.00	.00	.00
650.00	.00	.00	.00	.00	.00
655.00	.00	.00	.00	.00	.00
660.00	.00	.00	.00	.00	.00
665.00	.00	.00	.00	.00	.00
670.00	.00	.00	.00	.00	.00
675.00	.00	.00	.00	.00	.00
680.00	.00	.00	.00	.00	.00
685.00	.00	.00	.00	.00	.00
690.00	.00	.00	.00	.00	.00
695.00	.00	.00	.00	.00	.00
700.00	.00				

Type... Outlet Input Data
Name... OS 44 BLOCKED

File... C:\MY DOCUMENTS\AVONDALE HEIGHTS DETENTION.PPW
Title... Overflow Structure 44 in Basin B of Avondale Heights

REQUESTED POND WS ELEVATIONS:

Min. Elev.= 498.00 ft
Increment = .10 ft
Max. Elev.= 502.00 ft

OUTLET CONNECTIVITY

---> Forward Flow Only (UpStream to DnStream)
<--- Reverse Flow Only (DnStream to UpStream)
<---> Forward and Reverse Both Allowed

Structure	No.		Outfall	E1, ft	E2, ft
Stand Pipe	AI	--->	CV	499.200	502.000
Culvert-Circular	CV	--->	TW	497.000	502.000
TW SETUP, DS Channel					

Type.... Outlet Input Data
Name.... OS 44 BLOCKED

File.... C:\MY DOCUMENTS\AVONDALE HEIGHTS DETENTION.PPW
Title... Overflow Structure 44 in Basin B of Avondale Heights

OUTLET STRUCTURE INPUT DATA

Structure ID	=	AI
Structure Type	=	Stand Pipe

# of Openings	=	1
Invert Elev.	=	499.20 ft
Diameter	=	3.5000 ft
Orifice Area	=	9.6211 sq.ft
Orifice Coeff.	=	.600
Weir Length	=	11.00 ft
Weir Coeff.	=	3.000
K, Submerged	=	.000
K, Reverse	=	1.000
Kb, Barrel	=	.000000 (per ft of full flow)
Barrel Length	=	.00 ft
Mannings n	=	.0000

File.... C:\MY DOCUMENTS\AVONDALE HEIGHTS DETENTION.PPW
Title... Overflow Structure 44 in Basin B of Avondale Heights

OUTLET STRUCTURE INPUT DATA

Structure ID = CV
Structure Type = Culvert-Circular

No. Barrels = 1
Barrel Diameter = 2.0000 ft
Upstream Invert = 497.00 ft
Dnstream Invert = 496.00 ft
Horiz. Length = 46.24 ft
Barrel Length = 46.25 ft
Barrel Slope = .02163 ft/ft

OUTLET CONTROL DATA...

Mannings n = .0130
Ke = .5000 (forward entrance loss)
Kb = .012411 (per ft of full flow)
Kr = .5000 (reverse entrance loss)
HW Convergence = .001 +/- ft

INLET CONTROL DATA...

Equation form = 1
Inlet Control K = .0078
Inlet Control M = 2.0000
Inlet Control c = .02920
Inlet Control Y = .7400
T1 ratio (HW/D) = 1.125
T2 ratio (HW/D) = 1.196
Slope Factor = -.500

Use unsubmerged inlet control Form 1 equ. below T1 elev.
Use submerged inlet control Form 1 equ. above T2 elev.

In transition zone between unsubmerged and submerged inlet control,
interpolate between flows at T1 & T2...

At T1 Elev = 499.25 ft ---> Flow = 15.55 cfs
At T2 Elev = 499.39 ft ---> Flow = 17.77 cfs

Structure ID = TW
Structure Type = TW SETUP, DS Channel

FREE OUTFALL CONDITIONS SPECIFIED

CONVERGENCE TOLERANCES...

Maximum Iterations= 30
Min. TW tolerance = .01 ft
Max. TW tolerance = .01 ft
Min. HW tolerance = .01 ft
Max. HW tolerance = .01 ft
Min. Q tolerance = .10 cfs
Max. Q tolerance = .10 cfs

File... C:\MY DOCUMENTS\AVONDALE HEIGHTS DETENTION.PPW
 Title... Overflow Structure 44 in Basin B of Avondale Heights

***** COMPOSITE OUTFLOW SUMMARY *****

WS Elev, Total Q		Converge		Notes
Elev. ft	Q cfs	TW Elev ft	Error +/-ft	Contributing Structures
498.00	.00	Free	Outfall	(no Q: AI,CV)
498.10	.00	Free	Outfall	(no Q: AI,CV)
498.20	.00	Free	Outfall	(no Q: AI,CV)
498.30	.00	Free	Outfall	(no Q: AI,CV)
498.40	.00	Free	Outfall	(no Q: AI,CV)
498.50	.00	Free	Outfall	(no Q: AI,CV)
498.60	.00	Free	Outfall	(no Q: AI,CV)
498.70	.00	Free	Outfall	(no Q: AI,CV)
498.80	.00	Free	Outfall	(no Q: AI,CV)
498.90	.00	Free	Outfall	(no Q: AI,CV)
499.00	.00	Free	Outfall	(no Q: AI,CV)
499.10	.00	Free	Outfall	(no Q: AI,CV)
499.20	.00	Free	Outfall	(no Q: AI,CV)
499.30	1.04	Free	Outfall	AI,CV
499.40	2.95	Free	Outfall	AI,CV
499.50	5.42	Free	Outfall	AI,CV
499.60	8.34	Free	Outfall	AI,CV
499.70	11.66	Free	Outfall	AI,CV
499.80	19.25	Free	Outfall	AI,CV
499.90	20.18	Free	Outfall	AI,CV
500.00	21.07	Free	Outfall	AI,CV
500.10	21.97	Free	Outfall	AI,CV
500.20	22.84	Free	Outfall	AI,CV
500.30	23.68	Free	Outfall	AI,CV
500.40	24.52	Free	Outfall	AI,CV
500.50	25.34	Free	Outfall	AI,CV
500.60	26.13	Free	Outfall	AI,CV
500.70	26.91	Free	Outfall	AI,CV
500.80	27.67	Free	Outfall	AI,CV
500.90	28.41	Free	Outfall	AI,CV
501.00	29.14	Free	Outfall	AI,CV
501.10	29.84	Free	Outfall	AI,CV
501.20	30.45	Free	Outfall	AI,CV
501.30	30.99	Free	Outfall	AI,CV
501.40	31.53	Free	Outfall	AI,CV
501.50	32.07	Free	Outfall	AI,CV
501.60	32.59	Free	Outfall	AI,CV
501.70	33.10	Free	Outfall	AI,CV
501.80	33.61	Free	Outfall	AI,CV

Type.... Composite Rating Curve
Name.... OS 44 BLOCKED

File.... C:\MY DOCUMENTS\AVONDALE HEIGHTS DETENTION.PPW
Title... Overflow Structure 44 in Basin B of Avondale Heights

***** COMPOSITE OUTFLOW SUMMARY *****

WS Elev, Total Q		Converge		Notes
Elev. ft	Q cfs	TW Elev ft	Error +/-ft	Contributing Structures
501.90	34.11	Free Outfall		AI,CV
502.00	34.59	Free Outfall		AI,CV

Type.... Pond Routing Summary
Name.... BASIN B OUT Tag: C 100y
File.... C:\MY DOCUMENTS\AVONDALE HEIGHTS DETENTION.PPW
Storm... C 100yr Tag: C 100y

Page 3.01
Event: C 100yr

LEVEL POOL ROUTING SUMMARY

HYG Dir = C:\MY DOCUMENTS\
Inflow HYG file = NONE STORED - BASIN B IN C 100y
Outflow HYG file = NONE STORED - BASIN B OUT C 100y

Pond Node Data = BASIN B
Pond Volume Data = BASIN B
Pond Outlet Data = OS 44 BLOCKED

No Infiltration

INITIAL CONDITIONS

Starting WS Elev = 498.00 ft
Starting Volume = 0 cu.ft
Starting Outflow = .00 cfs
Starting Infiltr. = .00 cfs
Starting Total Qout= .00 cfs
Time Increment = 1.00 min

INFLOW/OUTFLOW HYDROGRAPH SUMMARY

=====
Peak Inflow = 63.05 cfs at 5.00 min
Peak Outflow = 17.26 cfs at 24.00 min

Peak Elevation = 499.77 ft
Peak Storage = 70543 cu.ft
=====

MASS BALANCE (cu.ft)

+ Initial Vol = 0
+ HYG Vol IN = 75660
- Infiltration = 0
- HYG Vol OUT = 28774
- Retained Vol = 46886

Unrouted Vol = - cu.ft (.001% of Inflow Volume)

Type.... Pond Routed HYG (total out)
 Name.... BASIN B OUT Tag: C 100y
 File.... C:\MY DOCUMENTS\AVONDALE HEIGHTS DETENTION.PPW
 Storm... C 100yr Tag: C 100y

Page 3.02
 Event: C 100yr

POND ROUTED TOTAL OUTFLOW HYG...

HYG file =
 HYG ID = BASIN B OUT
 HYG Tag = C 100y

 Peak Discharge = 17.26 cfs
 Time to Peak = 24.00 min
 HYG Volume = 28774 cu.ft

HYDROGRAPH ORDINATES (cfs)

Output Time increment = 1.00 min
 Time on left represents time for first value in each row.

Time min					
.00	.00	.00	.00	.00	.00
5.00	.00	.00	.00	.00	.00
10.00	.00	.00	.00	.00	.00
15.00	.11	1.09	2.79	4.88	7.20
20.00	9.67	12.10	15.40	17.07	17.26
25.00	16.13	14.47	12.97	11.65	11.11
30.00	10.59	10.10	9.62	9.18	8.75
35.00	8.34	7.99	7.66	7.34	7.04
40.00	6.75	6.47	6.20	5.94	5.70
45.00	5.46	5.26	5.07	4.89	4.72
50.00	4.55	4.39	4.24	4.09	3.94
55.00	3.80	3.67	3.54	3.41	3.29
60.00	3.18	3.07	2.96	2.87	2.79
65.00	2.72	2.64	2.57	2.50	2.43
70.00	2.36	2.30	2.23	2.17	2.11
75.00	2.05	2.00	1.94	1.89	1.84
80.00	1.79	1.74	1.69	1.64	1.60
85.00	1.55	1.51	1.47	1.43	1.39
90.00	1.35	1.31	1.28	1.24	1.21
95.00	1.17	1.14	1.11	1.08	1.05
100.00	1.03	1.01	1.00	.98	.97
105.00	.95	.94	.93	.91	.90
110.00	.88	.87	.86	.84	.83
115.00	.82	.81	.79	.78	.77
120.00	.76	.75	.73	.72	.71
125.00	.70	.69	.68	.67	.66
130.00	.65	.64	.63	.62	.61
135.00	.60	.59	.58	.57	.57
140.00	.56	.55	.54	.53	.52
145.00	.52	.51	.50	.49	.48
150.00	.48	.47	.46	.46	.45
155.00	.44	.44	.43	.42	.42
160.00	.41	.40	.40	.39	.38

Type... Pond Routed HYG (total out)
 Name... BASIN B OUT Tag: C 100y
 File... C:\MY DOCUMENTS\AVONDALE HEIGHTS DETENTION.PPW
 Storm... C 100yr Tag: C 100y

HYDROGRAPH ORDINATES (cfs)
 Output Time increment = 1.00 min
 Time on left represents time for first value in each row.

Time min					
165.00	.38	.37	.37	.36	.36
170.00	.35	.35	.34	.34	.33
175.00	.32	.32	.32	.31	.31
180.00	.30	.30	.29	.29	.28
185.00	.28	.27	.27	.27	.26
190.00	.26	.25	.25	.25	.24
195.00	.24	.24	.23	.23	.22
200.00	.22	.22	.21	.21	.21
205.00	.20	.20	.20	.20	.19
210.00	.19	.19	.18	.18	.18
215.00	.18	.17	.17	.17	.17
220.00	.16	.16	.16	.16	.15
225.00	.15	.15	.15	.14	.14
230.00	.14	.14	.14	.13	.13
235.00	.13	.13	.13	.12	.12
240.00	.12	.12	.12	.11	.11
245.00	.11	.11	.11	.11	.10
250.00	.10	.10	.10	.10	.10
255.00	.09	.09	.09	.09	.09
260.00	.09	.09	.09	.08	.08
265.00	.08	.08	.08	.08	.08
270.00	.08	.07	.07	.07	.07
275.00	.07	.07	.07	.07	.07
280.00	.06	.06	.06	.06	.06
285.00	.06	.06	.06	.06	.06
290.00	.06	.05	.05	.05	.05
295.00	.05	.05	.05	.05	.05
300.00	.05	.05	.05	.05	.04
305.00	.04	.04	.04	.04	.04
310.00	.04	.04	.04	.04	.04
315.00	.04	.04	.04	.04	.04
320.00	.03	.03	.03	.03	.03
325.00	.03	.03	.03	.03	.03
330.00	.03	.03	.03	.03	.03
335.00	.03	.03	.03	.03	.03
340.00	.03	.03	.02	.02	.02
345.00	.02	.02	.02	.02	.02
350.00	.02	.02	.02	.02	.02
355.00	.02	.02	.02	.02	.02
360.00	.02	.02	.02	.02	.02
365.00	.02	.02	.02	.02	.02
370.00	.02	.02	.02	.02	.02
375.00	.01	.01	.01	.01	.01
380.00	.01	.01	.01	.01	.01
385.00	.01	.01	.01	.01	.01
390.00	.01	.01	.01	.01	.01
395.00	.01	.01	.01	.01	.01

Type... Pond Routed HYG (total out) Page 3.04
 Name... BASIN B OUT Tag: C 100y Event: C 100yr
 File... C:\MY DOCUMENTS\AVONDALE HEIGHTS DETENTION.PPW
 Storm... C 100yr Tag: C 100y

HYDROGRAPH ORDINATES (cfs)
 Output Time increment = 1.00 min
 Time on left represents time for first value in each row.

Time min					
400.00	.01	.01	.01	.01	.01
405.00	.01	.01	.01	.01	.01
410.00	.01	.01	.01	.01	.01
415.00	.01	.01	.01	.01	.01
420.00	.01	.01	.01	.01	.01
425.00	.01	.01	.01	.01	.01
430.00	.01	.01	.01	.01	.01
435.00	.01	.01	.01	.01	.01
440.00	.01	.01	.01	.01	.01
445.00	.01	.01	.00	.00	.00
450.00	.00	.00	.00	.00	.00
455.00	.00	.00	.00	.00	.00
460.00	.00	.00	.00	.00	.00
465.00	.00	.00	.00	.00	.00
470.00	.00	.00	.00	.00	.00
475.00	.00	.00	.00	.00	.00
480.00	.00				

Index of Starting Page Numbers for ID Names

----- 0 -----
05 44 BLOCKED... 2.01, 2.04

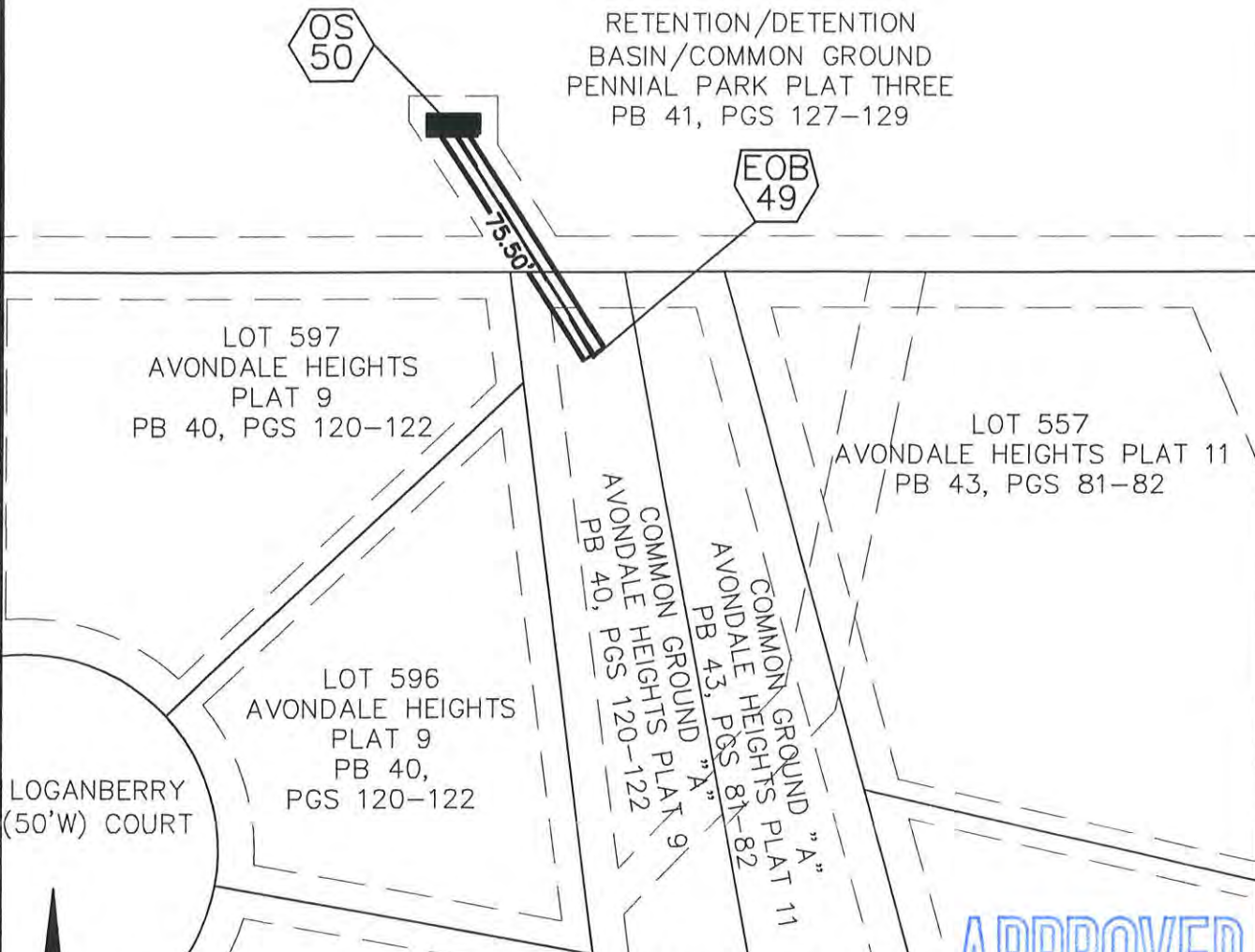

SEWER MEASUREMENTS

APPROVED

1/8/09
RKC

THE EXISTING SEWER LENGTHS, SIZES, FLOWLINES, DEPTHS OF STRUCTURES AND SEWERS AND LOCATIONS WITH RESPECT TO EXISTING OR PROPOSED EASEMENTS HAVE BEEN MEASURED. THE RESULTS OF THOSE MEASUREMENTS ARE SHOWN ON THIS SET OF FINAL MEASUREMENT PLANS.

SCALE: 1' = 50'

ALL PUBLIC SEWERS ARE LOCATED WITHIN DESIGNATED EXISTING OR PROPOSED EASEMENTS EXCEPT AS FOLLOWS:

EXHIBIT A

DATE	12/02/08
DRAWN	JLH

STORM SEWER AS-BUILT EXHIBIT

INITIALS:

PROJECT	96-8791
FILE	8791ASB-49-50

A TRACT OF LAND BEING PART OF SECTION 4, TOWNSHIP 46 NORTH, RANGE 3 EAST, OF THE FIFTH PRINCIPAL MERIDIAN CITY OF O'FALLON, ST. CHARLES COUNTY, MISSOURI

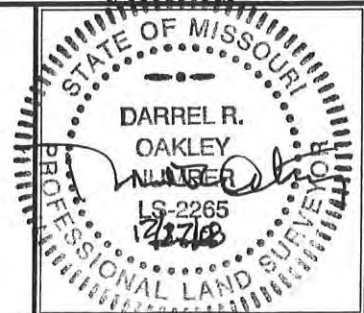

EOB
49

OS
50

T.Q. = 545.46 c.f.s.

530

530

520

520

510

510

500

500

490

490

NORMAL WATER
ELEV.: 516.00

FL OUT 514.00
FL OUT 513.88

FL IN 514.30
FL IN 514.09

75.67' ~ 3'x6'

Box Culvert

@ 0.40%

75.50' ~ 3'x6'

BOX CULVERT

@ 0.28%



SCALE: 1' = 50'

PAGE 2 OF 3

EXHIBIT A

DATE 12/02/08
DRAWN JLH

STORM SEWER AS-BUILT EXHIBIT

INITIALS:

PROJECT 96-8791
FILE 8791ASB-49-50

A TRACT OF LAND BEING PART OF SECTION 4,
TOWNSHIP 46 NORTH, RANGE 3 EAST,
OF THE FIFTH PRINCIPAL MERIDIAN
CITY OF O'FALLON,
ST. CHARLES COUNTY, MISSOURI

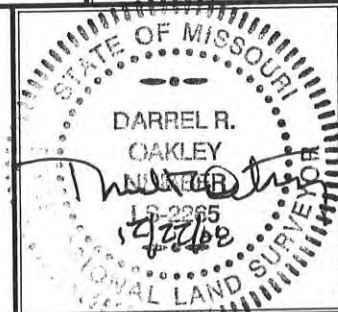

OUTFALL STRUCTURE 50 DETAIL
NOT TO SCALE
PLAN VIEW

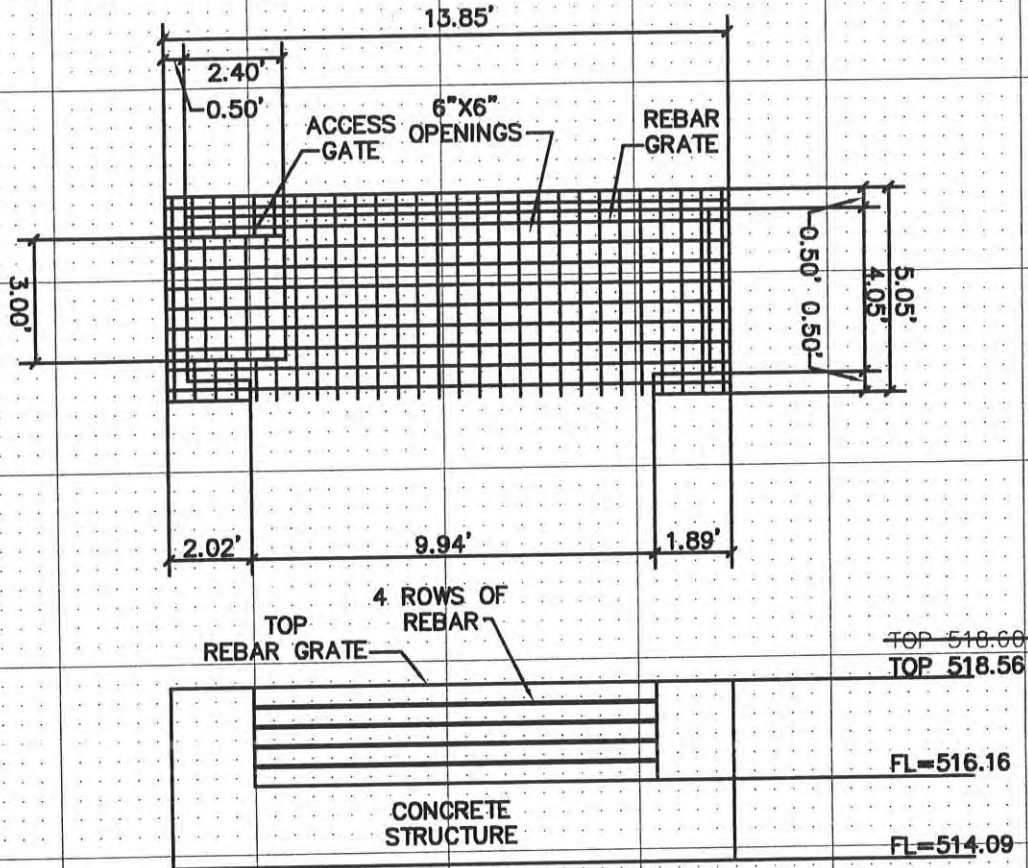

OUTFALL STRUCTURE 50 DETAIL
NOT TO SCALE
PROFILE VIEW

SCALE:

PAGE 3 OF 3.

EXHIBIT A

DATE	12/02/08
DRAWN	JLH

STORM SEWER AS-BUILT EXHIBIT

INITIALS:

PROJECT	96-8791
FILE	8791ASB-49-50

A TRACT OF LAND BEING PART OF SECTION 4,
TOWNSHIP 46 NORTH, RANGE 3 EAST,
OF THE FIFTH PRINCIPAL MERIDIAN
CITY OF O'FALLON,
ST. CHARLES COUNTY, MISSOURI

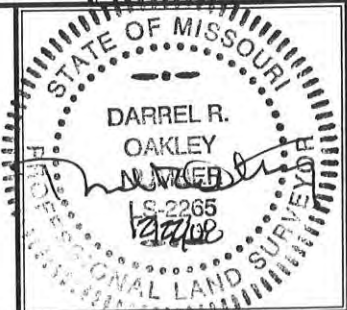



NOTE:
ALL FLOWS ARE 25 YEAR FREQUENCY

- LEGEND:**
- UNDEVELOPED DIRECT RUNOFF
 - ON-SITE RUNOFF TO PROPOSED BASINS
 - DEVELOPED DIRECT RUNOFF

PREPARED FOR: **POST-DEVELOPED DRAINAGE AREA MAP**

DISCLAIMER OF RESPONSIBILITY
The Engineer and his firm are not responsible for the accuracy of the information provided in this drawing. The user of this drawing is advised to verify all data and to consult the original drawings and specifications. The Engineer and his firm are not responsible for any errors or omissions in this drawing or for any consequences arising from the use of this drawing.

Copyright 2002
S&S Engineering Company, Inc.
All Rights Reserved

NO.	DATE	DESCRIPTION



**ENGINEERING
PLANNING
SURVEYING**

1608 South Cloverleaf Drive
St. Peters, MD, 63376-6445
836-928-6552
FAX 828-1718

08-09-02
 DATE
 96-8791;95-7230
 PROJECT NUMBER
 4 OF 4
 SHEET OF
 8791DAMEXBT.DWG
 FILE NAME
 JD
 DRAWN CHECKED



PREPARED FOR: **POST-DEVELOPED DRAINAGE AREA MAP**

DECLARATION OF RESPONSIBILITY
I hereby certify that the documents prepared by me are true and correct to the best of my knowledge and belief, and I hereby accept any responsibility for all errors, omissions, inaccuracies, and other documents or instruments resulting therefrom, and I agree to be bound by the terms and conditions of the contract and any amendments thereto.

Copyright 2002
Sox Engineering Company, Inc.
All Rights Reserved.

NO.	DATE	REVISIONS

BAT
**ENGINEERING
 PLANNING
 SURVEYING**
 1052 South Cloverleaf Drive
 St. Peters, MD. 21766-6445
 636-928-5552
 FAX 928-1718

NOTE:
ALL FLOWS ARE 25 YEAR FREQUENCY

LEGEND:

	UNDEVELOPED DIRECT RUNOFF
	ON-SITE RUNOFF TO PROPOSED BASINS
	DEVELOPED DIRECT RUNOFF

DATE	08-09-02
PROJECT NUMBER	96-8791;95-7230
SHEET OF	3 OF 4
FILE NAME	8791DAMEXBT.DWG
DRAWN	JD
CHECKED	



NOTE:
ALL FLOWS ARE 25 YEAR FREQUENCY

PREPARED FOR: **PRE-DEVELOPED DRAINAGE AREA MAP**

DISCLAIMER OF RESPONSIBILITY
I hereby certify that the documents herein
to be authorized by my seal and signature
and that I am a duly licensed Professional Engineer
in the State of Maryland. I am not responsible for
any errors or omissions in the documents or for
any consequences resulting therefrom or for
any part or parts of the architectural
engineering project or survey.

Copyright 2002
The Engineering Company, Inc.
All Rights Reserved

REVISIONS

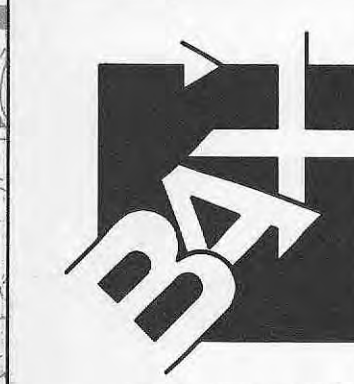

**ENGINEERING
PLANNING
SURVEYING**
1055 South Cloverleaf Dr.
St. Peters, MO. 63376-04
636-928-5552
FAX 928-1718

08-09-02
DATE
96-8791.95-72
PROJECT NUMBER
2 OF 4
SHEET OF
8791DAMEXB.DWG
FILE NAME
JD
DRAWN CHECKED

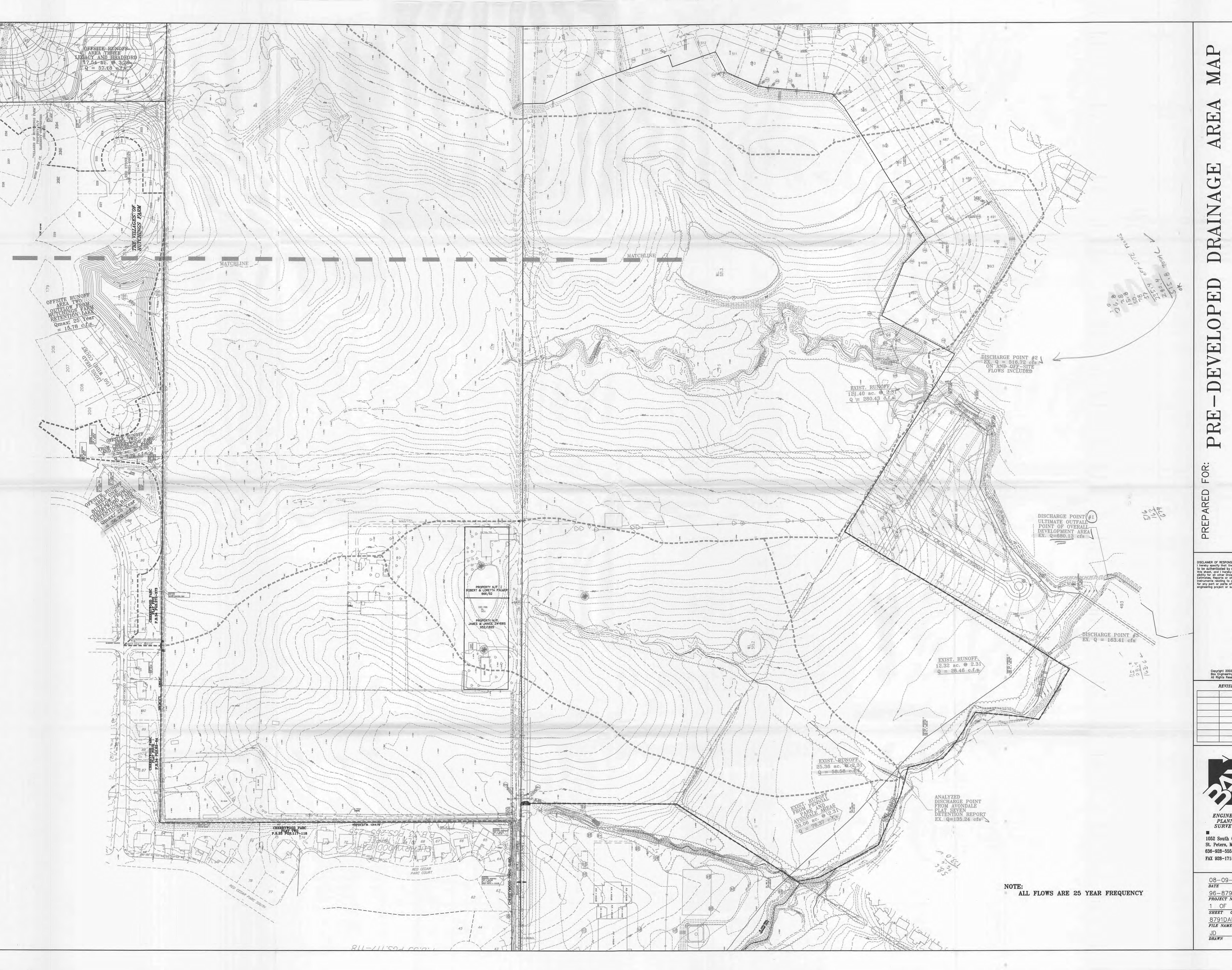

PREPARED FOR: PRE-DEVELOPED DRAINAGE AREA MAP

DISCLAIMER OF RESPONSIBILITY: I hereby certify that the information contained herein is true and correct to the best of my knowledge and belief, and that I am not aware of any facts or circumstances which would render this information misleading or incomplete. I accept full responsibility for the accuracy of the information herein.

DATE: 08-09
 06-879
 PROJECT N
 1 OF
 SHEET C
 8791DA
 FILE NAME
 JD
 DRAWN

NO.	DATE	DESCRIPTION

ENGINEERING SURVEY
 1062 South
 St. Peters, MO
 636-928-5555
 FAX 928-1711

NOTE: ALL FLOWS ARE 25 YEAR FREQUENCY

Handwritten notes and calculations in the upper right corner, including a table of values and a signature.

Handwritten notes: 5.6, 1.02, 6.6

Handwritten notes: 7.5, 2.8, 10.3

Handwritten notes: 0.56, 5.8

811-711-5011